

# C500-LDP01-V1

## Ladder Program I/O Unit

### Operation Manual

*Revised January 1992*

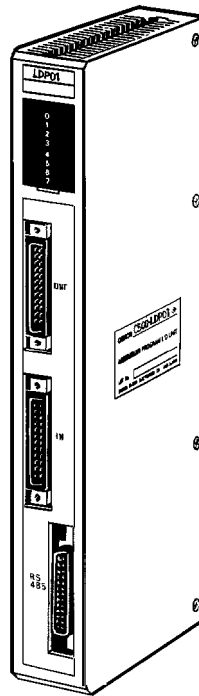



## **Notice:**

OMRON products are manufactured for use according to proper procedures by a qualified operator and only for the purposes described in this manual.

The following conventions are used to indicate and classify warnings in this manual. Always heed the information provided with them.

**Caution** Indicates information that, if not heeded, could result in minor injury or damage to the product.

**DANGER!** Indicates information that, if not heeded, could result in loss of life or serious injury.

## **OMRON Product References**

All OMRON products are capitalized in this manual. The word "Unit" is also capitalized when it refers to an OMRON product, regardless of whether or not it appears in the proper name of the product.

The abbreviation "Ch," which appears in some displays and on some OMRON products, often means "word" and is abbreviated "Wd" in documentation in this sense.

The abbreviation "PC" means Programmable Controller and is not used as an abbreviation for anything else.

## **Visual Aids**

The following headings appear in the left column of the manual to help you locate different types of information.

**Note** Indicates information of particular interest for efficient and convenient operation of the product.

**1, 2, 3...** 1. Indicates lists of one sort or another, such as procedures, checklists, etc.

## **© OMRON, 1992**

All rights reserved. No part of this publication may be reproduced, stored in a retrieval system, or transmitted, in any form, or by any means, mechanical, electronic, photocopying, recording, or otherwise, without the prior written permission of OMRON.

No patent liability is assumed with respect to the use of the information contained herein. Moreover, because OMRON is constantly striving to improve its high-quality products, the information contained in this manual is subject to change without notice. Every precaution has been taken in the preparation of this manual. Nevertheless, OMRON assumes no responsibility for errors or omissions. Neither is any liability assumed for damages resulting from the use of the information contained in this publication.



# TABLE OF CONTENTS

## SECTION 1

|  |          |
|--|----------|
| <b>Introduction</b> .....                                | <b>1</b> |
| 1-1 Features .....                                       | 2        |
| 1-2 System Configuration .....                           | 2        |
| 1-3 Comparing the C500-LDP01 and the C500-LDP01-V1 ..... | 3        |
| 1-4 Nomenclature .....                                   | 4        |

## SECTION 2

|  |          |
|--|----------|
| <b>Preparations</b> .....                    | <b>5</b> |
| 2-1 Front Panel Switches and Selectors ..... | 6        |
| 2-2 Back Panel DIP Switch .....              | 11       |

## SECTION 3

|                                     |           |
|-------------------------------------|-----------|
| <b>Data Areas</b> .....             | <b>13</b> |
| 3-1 IR (Internal Relay) Area .....  | 14        |
| 3-2 Work Bits .....                 | 17        |
| 3-3 SR (Special Relay) Area .....   | 18        |
| 3-4 TR (Temporary Relay) Bits ..... | 18        |
| 3-5 TC (Timer/Counter) Area .....   | 18        |
| 3-6 DM (Data Memory) Area .....     | 18        |

## SECTION 4

|   |           |
|---|-----------|
| <b>Programming</b> .....                        | <b>21</b> |
| 4-1 Program Addresses and Memory Capacity ..... | 22        |
| 4-2 Operating Modes .....                       | 22        |
| 4-3 Changing the Operating Mode .....           | 22        |
| 4-4 Programming Devices .....                   | 23        |
| 4-5 Online Operations .....                     | 24        |

## SECTION 5

|  |           |
|--|-----------|
| <b>Program Execution Timing</b> .....        | <b>27</b> |
| 5-1 Operation in RUN and MONITOR Modes ..... | 28        |
| 5-2 Scan Time .....                          | 28        |
| 5-3 Instruction Execution Times .....        | 29        |
| 5-4 I/O Response Time .....                  | 32        |

## SECTION 6

|  |           |
|--|-----------|
| <b>Maintenance and Troubleshooting</b> ..... | <b>35</b> |
| 6-1 Error Messages and Troubleshooting ..... | 36        |
| 6-2 Maintenance .....                        | 37        |

## Appendices

|   |    |
|---|----|
| A Standard Models .....                     | 39 |
| B Specifications .....                      | 41 |
| C Programming Instructions .....            | 45 |
| D Error and Arithmetic Flag Operation ..... | 55 |

|                    |           |
|--------------------|-----------|
| <b>Index</b> ..... | <b>57</b> |
|--------------------|-----------|

|                                  |           |
|----------------------------------|-----------|
| <b>OMRON Sales Offices</b> ..... | <b>59</b> |
|----------------------------------|-----------|

|                               |           |
|-------------------------------|-----------|
| <b>Revision History</b> ..... | <b>63</b> |
|-------------------------------|-----------|

## ***About this Manual:***

This manual describes the installation and operation of the C500-LD01-V1 Ladder Program I/O Unit and includes the sections described below.

Please read this manual completely and be sure you understand the information provide before attempting to install and operation the Ladder Program I/O Unit.

**Section 1** introduces the Unit and describes its components and the way it fits into a PC system. A comparison of the C500-LD01-V1 and the C500-LD01 is also provided.

**Section 2** provides information on switch settings and how certain switch settings affect indicator operation. These switch must be set before mounting and operating the Unit.

**Section 3** describes the data areas available for use in programming the Unit.

**Section 4** provides information related to programming and operating the Unit. A list of programming instructions is provided in *Appendix C Programming Instructions*. Details on programming can be found in the *C500 Operation Manual*.

**Section 5** describes the scan of the Unit and how the operating mode affects it. It also describes scan time and I/O response time calculations and provides tables of instruction execution times.

**Section 6** provides basic troubleshooting steps, error messages provided by the indicators, and the fuse replacement procedure.

# SECTION 1

## Introduction

This section introduces the main features and applications of the Ladder Program I/O Unit and describes how it relates to I/O devices and Programming Devices. It also provides a table that describes additions made to the V1 version of the Unit and provides the names and locations of the various parts of the Unit.

|     |  |   |
|-----|--|---|
| 1-1 | Features .....                                       | 2 |
| 1-2 | System Configuration .....                           | 2 |
| 1-3 | Comparing the C500-LDP01 and the C500-LDP01-V1 ..... | 3 |
| 1-4 | Nomenclature .....                                   | 4 |

## 1-1 Features

The C500-LDP01-V1 Ladder Program I/O Unit executes a ladder program to control external I/O independently of the PC. The ladder program contained in the Unit is written by the user.

The C500-LDP01-V1 Ladder Program I/O Unit can be used with the following SYSMAC C-series PCs: C500, C1000H, C2000H.

### Applications Examples

- External I/O can be controlled by the Ladder Program I/O Unit instead of the PC.
- The Ladder Program I/O Unit can be used as a timer.
- The Ladder Program I/O Unit can be used as a high-speed input unit.
- By controlling external inputs and outputs, the Ladder Program I/O Unit can reduce the processing load handled by the PC.

### C500 Instructions

The Ladder Program I/O Unit uses the same instructions as the C500, so ladder programs can be constructed in the same way. A total of 49 different instructions is available. (Not all C500 instructions are supported.)

### External I/O Points: 16 Input/16 Output

The 16 DC inputs and 16 transistor outputs can be connected to external I/O devices so the Unit can be used as for normal I/O operation. Of the 16 DC inputs, 8 inputs (2 groups of 4) can be set for high-speed inputs with a minimum pulse width of 0.5 ms, so inputs shorter than the scan time can be detected.

### PC I/O Points: 16 Input and 16 Output

The Unit connects to the PC through 16 input points and 16 output points, so control signals can be passed back and forth between the PC and the Unit. Furthermore, when the I/O WRITE and I/O READ (WRIT(87)/READ(88)) instructions are executed in the PC program, up to 32 words of data can be transferred to or from the Unit.

### Built-in Realtime Clock

A realtime clock is built into the Unit, so it can act as a timer and manage I/O timing.

## 1-2 System Configuration

The following figure shows a typical system configuration:

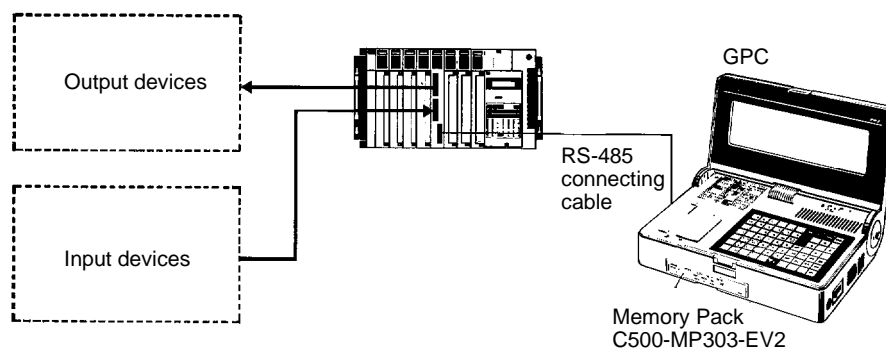

The Unit can be programmed through the GPC with Memory Pack C500-MP303-EV2, through the FIT, or through LSS running on an IBM AT/XT compatible computer. Refer to *Appendix C Programming Instructions* for a list of instructions. Online operations between the Unit and the GPC/FIT/LSS are possible in PROGRAM or MONITOR mode. They are not possible in RUN mode.



### 1-3 Comparing the C500-LDP01 and the C500-LDP01-V1

The following table shows the improvements that have been made to create the C500-LDP01-V1.

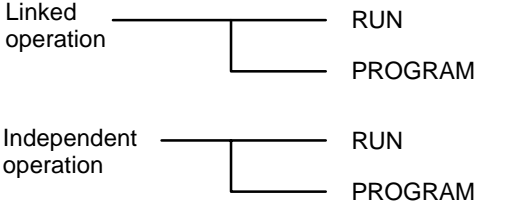
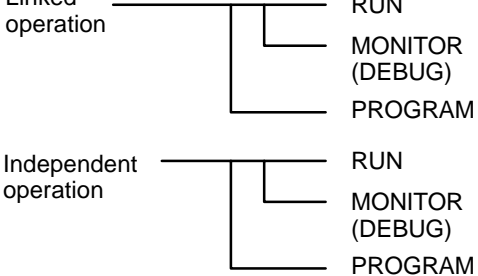
| Item                      | C500-LDP01   | C500-LDP01-V1   |
|---------------------------|--|---|
| Instruction set           | 40 instructions  | The following instructions were added to make a total of 49 instructions.<br>ASL(25): ARITHMETIC SHIFT LEFT<br>ASR(26): ARITHMETIC SHIFT RIGHT<br>ROL(27): ROTATE LEFT<br>ROR(28): ROTATE RIGHT<br>COM(29): COMPLEMENT<br>INC(38): INCREMENT<br>DEC(39): DECREMENT<br>SLD(74): ONE DIGIT SHIFT LEFT<br>SRD(75): ONE DIGIT SHIFT RIGHT |
| Number of words allocated | 2 words<br>16 PC output bits (0000 through 0015)<br>16 PC input bits (0100 through 0115)<br><br>The PC cannot access the Unit using the I/O WRITE and the I/O READ (WRIT(87)/READ(88)) instructions. | 2 words<br>16 PC output bits (0000 through 0015)<br>16 PC input bits (0100 through 0115)<br><br>With the proper switch settings, the PC can control the Unit using the I/O WRITE and I/O READ (WRIT(87)/READ(88)) instructions.<br>(Up to 32 words are written or read.)  |
| Operating modes           |  <p>The GPC/FIT/LSS* can operate with the Unit in PROGRAM mode only.</p>   |  <p>The GPC/FIT/LSS* can operate with the Unit in either PROGRAM or MONITOR (debug) mode.</p>  |

\*GPC: Graphic Programming Console  
 FIT: Factory Intelligent Terminal  
 LSS: Ladder Support Software

# 1-4 Nomenclature

Front Panel

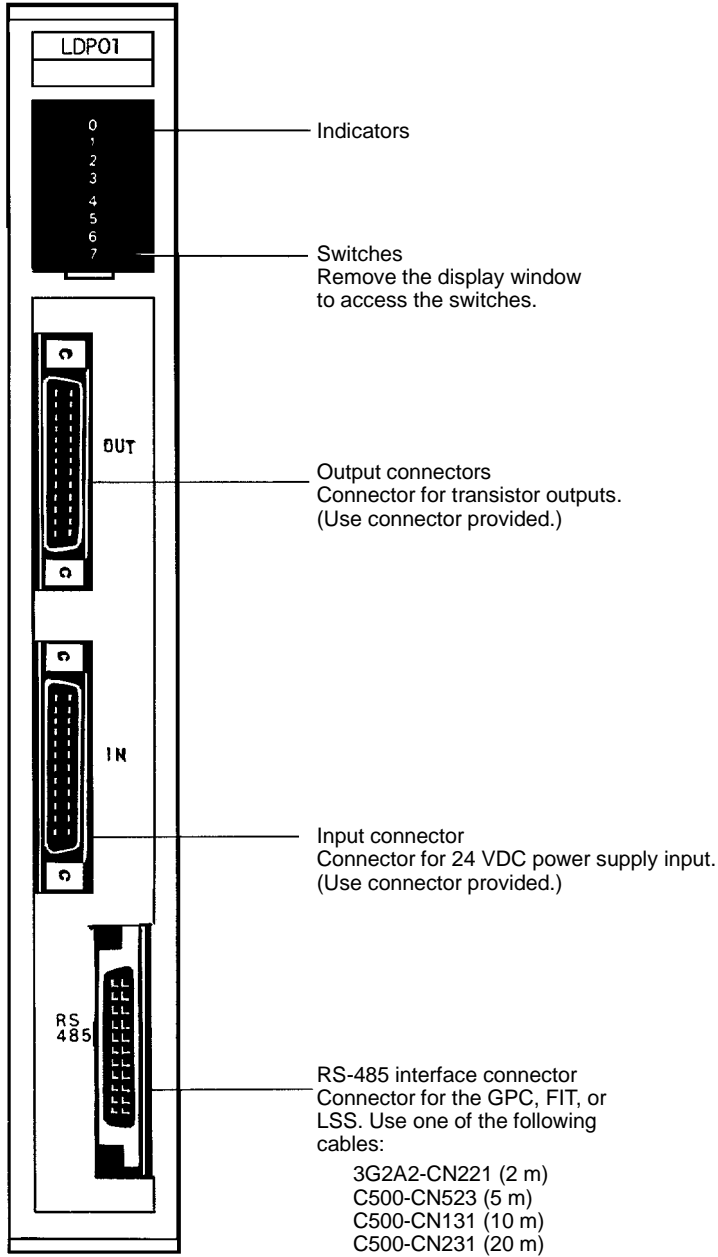

Back Panel

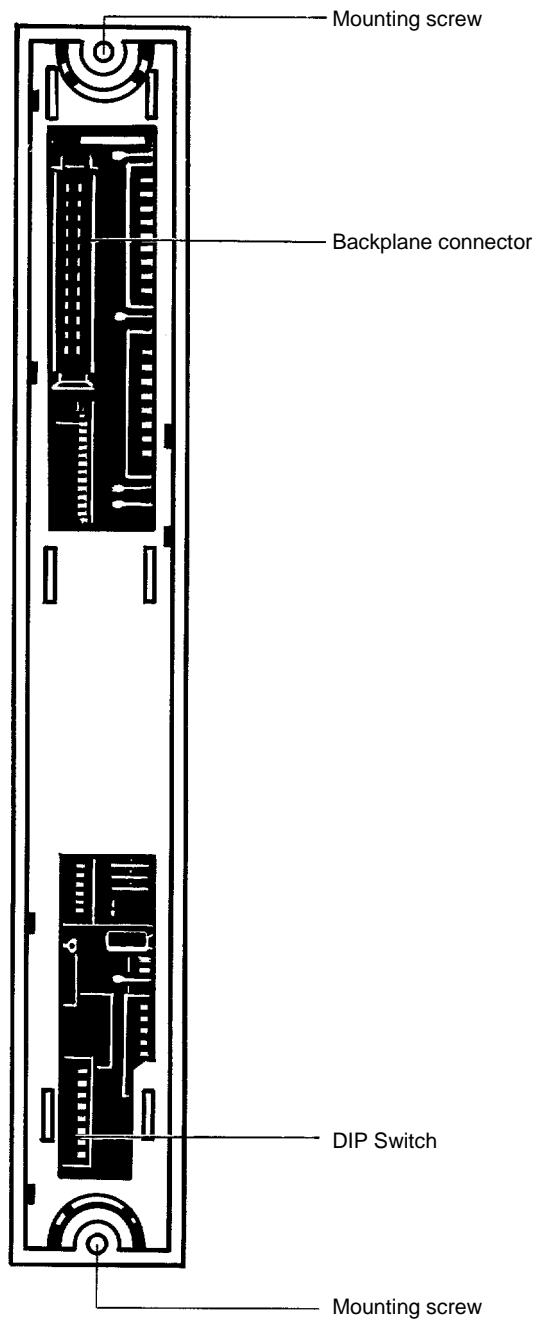

# SECTION 2

## Preparations

This section describes the switch settings required prior to operation. The operation of Unit indicators, which are controlled by a switch setting, is also described.

|     |  |    |
|-----|--|----|
| 2-1 | Front Panel Switches and Selectors ..... | 6  |
| 2-2 | Back Panel DIP Switch .....              | 11 |

## 2-1 Front Panel Switches and Selectors

**Switch/Selector Location** Remove the display window using a standard screwdriver to access the switches and selectors shown below.

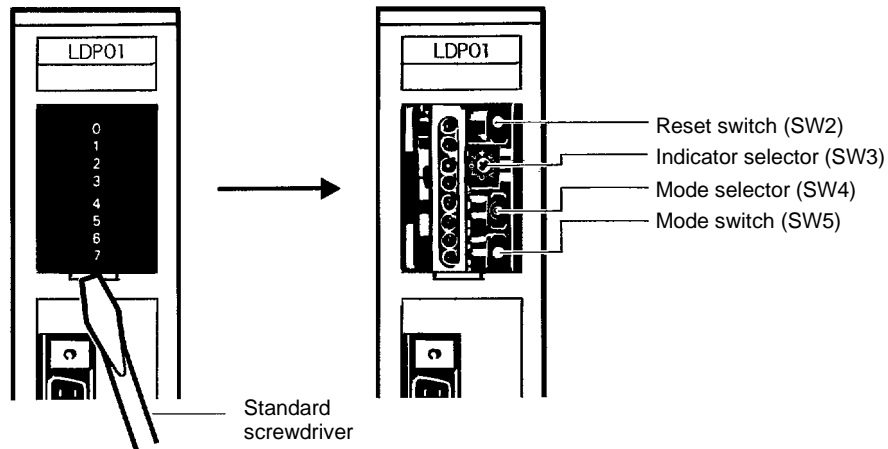

### Switch/Selector Functions

| Switch No. | Designation      | Function  |
|------------|------------------|---|
| SW 2       | Reset switch     | The Unit can be reset and restarted by pressing the reset switch.<br><b>Note</b> Resetting the Unit completely clears I/O bit status and data memory.<br>If the back panel DIP switch is set for PC-linked operation, the Unit will enter RUN or PROGRAM mode after resetting, depending on the status of the PC. If the back panel DIP switch is set for independent operation, the Unit will enter RUN, MONITOR (debug), or PROGRAM mode, depending on the setting of SW4. The same process occurs when the power is turned on. |
| SW 3       | Display selector | Select indicator operation with this selector. Refer to the following pages for details.  |
| SW 4       | Mode selector    | Changing this selector followed by pressing and releasing SW5 will alter the operating mode as shown below. This switch also determines the mode entered when power is turned on or the Unit is reset.<br>SW 4 set to up position . . . . . RUN<br>SW 4 set to center . . . . . MONITOR (debug)<br>SW 4 set to down position . . . . . PROGRAM  |
| SW 5       | Mode switch      | When this switch is pressed and released, the Unit will enter the mode set on SW4. The operation of this switch is enabled by turning on pin 5 of the back panel DIP switch, and disabled by turning off pin 5.<br><br>The Unit cannot be switched to RUN or MONITOR mode when the program is being transferred from a Programming Device or an error has occurred.   |

Display Selector

Switching the display selector (SW3) alters the indicator operation as follows:

| SW3 | Description                                     | Indicator | Function   |
|-----|---|-----------|--|
| 0   | Indicate operating mode                         | 0         | RUN<br>Lit during operation. Not lit in PROGRAM mode.  |
|     |   | 1         | MONITOR (debug)<br>Lit in MONITOR (debug) mode. Not lit in RUN or PROGRAM mode.  |
|     |   | 2         | PROGRAM<br>Lit in PROGRAM mode. Not lit during operation.  |
|     |   | 3         | PC stop<br>Lit while the PC is not in operation (either in PROGRAM mode or in case of error).  |
|     |   | 4         | Error<br>Lit to indicate an error during operation. Refer to 6-1 Error Messages and Troubleshooting for details.                                   |
|     |   | 5         | High-speed input 1 is set.<br>Lit when external input bits 0200 through 0203 are set for high-speed inputs (Pin 3 of the DIP switch is turned on). |
|     |   | 6         | High-speed input 2 is set.<br>Lit when external input bits 0204 through 0207 are set for high-speed inputs (Pin 4 of the DIP switch is turned on). |
|     |   | 7         | Communicating<br>Lit when the Unit is communicating with the GPC, FIT, or LSS.   |
| 1   | Indicate the status of output bits 0000 to 0007 | 0         | 0000<br>Lit while corresponding output is ON.  |
|     |   | 1         | 0001   |
|     |   | 2         | 0002   |
|     |   | 3         | 0003   |
|     |   | 4         | 0004   |
|     |   | 5         | 0005   |
|     |   | 6         | 0006   |
|     |   | 7         | 0007   |
| 2   | Indicate the status of output bits 0008 to 0015 | 0         | 0008<br>Lit while corresponding output is ON.  |
|     |   | 1         | 0009   |
|     |   | 2         | 0010   |
|     |   | 3         | 0011   |
|     |   | 4         | 0012   |
|     |   | 5         | 0013   |
|     |   | 6         | 0014   |
|     |   | 7         | 0015   |
| 3   | Indicate the status of input bits 0100 to 0107  | 0         | 0100<br>Lit while corresponding input is ON.   |
|     |   | 1         | 0101   |
|     |   | 2         | 0102   |
|     |   | 3         | 0103   |
|     |   | 4         | 0104   |
|     |   | 5         | 0105   |
|     |   | 6         | 0106   |
|     |   | 7         | 0107   |

| SW3 | Description  | Indicator | Function |                                       |
|-----|--|-----------|----------|---------------------------------------|
| 4   | Indicate the status of input bits 0108 to 0115           | 0         | 0108     | Lit while corresponding input is ON.  |
|     |  | 1         | 0109     |                                       |
|     |  | 2         | 0110     |                                       |
|     |  | 3         | 0111     |                                       |
|     |  | 4         | 0112     |                                       |
|     |  | 5         | 0113     |                                       |
|     |  | 6         | 0114     |                                       |
|     |  | 7         | 0115     |                                       |
| 5   | Indicate the status of external input bits 0200 to 0207  | 0         | 0200     | Lit while corresponding input is ON.  |
|     |  | 1         | 0201     |                                       |
|     |  | 2         | 0202     |                                       |
|     |  | 3         | 0203     |                                       |
|     |  | 4         | 0204     |                                       |
|     |  | 5         | 0205     |                                       |
|     |  | 6         | 0206     |                                       |
|     |  | 7         | 0207     |                                       |
| 6   | Indicate the status of external input bits 0208 to 0215  | 0         | 0208     | Lit while corresponding input is ON.  |
|     |  | 1         | 0209     |                                       |
|     |  | 2         | 0210     |                                       |
|     |  | 3         | 0211     |                                       |
|     |  | 4         | 0212     |                                       |
|     |  | 5         | 0213     |                                       |
|     |  | 6         | 0214     |                                       |
|     |  | 7         | 0215     |                                       |
| 7   | Indicate the status of external output bits 0300 to 0307 | 0         | 0300     | Lit while corresponding output is ON. |
|     |  | 1         | 0301     |                                       |
|     |  | 2         | 0302     |                                       |
|     |  | 3         | 0303     |                                       |
|     |  | 4         | 0304     |                                       |
|     |  | 5         | 0305     |                                       |
|     |  | 6         | 0306     |                                       |
|     |  | 7         | 0307     |                                       |

| SW3  | Description  | Indicator | Function |               |
|--|--|-----------|----------|---------------|
| 8  | Indicate the status of external output bits 0308 to 0315 | 0         | 0308     |               |
|  |  | 1         | 0309     |               |
|  |  | 2         | 0310     |               |
|  |  | 3         | 0311     |               |
|  |  | 4         | 0312     |               |
|  |  | 5         | 0313     |               |
|  |  | 6         | 0314     |               |
|  |  | 7         | 0315     |               |
| Lit while corresponding output is ON.                                  |  |           |          |               |
| 9  | Indicate the year of the clock                           | 0         | 8        | $\times 10^1$ |
|  |  | 1         | 4        |               |
|  |  | 2         | 2        |               |
|  |  | 3         | 1        |               |
|  |  | 4         | 8        | $\times 10^0$ |
|  |  | 5         | 4        |               |
|  |  | 6         | 2        |               |
|  |  | 7         | 1        |               |
| The last two digits of the calendar year are displayed. Data: 00 to 99 |  |           |          |               |
| A  | Indicate the month of the clock                          | 0         | ---      |               |
|  |  | 1         | ---      |               |
|  |  | 2         | ---      |               |
|  |  | 3         | 1        | $\times 10^1$ |
|  |  | 4         | 8        |               |
|  |  | 5         | 4        | $\times 10^0$ |
|  |  | 6         | 2        |               |
|  |  | 7         | 1        |               |
| Data: 01 to 12<br>Indicators 0 through 2 are always OFF.               |  |           |          |               |
| B  | Indicate the date of the clock                           | 0         | ---      |               |
|  |  | 1         | ---      |               |
|  |  | 2         | 2        | $\times 10^1$ |
|  |  | 3         | 1        |               |
|  |  | 4         | 8        | $\times 10^0$ |
|  |  | 5         | 4        |               |
|  |  | 6         | 2        |               |
|  |  | 7         | 1        |               |
| Data: 01 to 31<br>Indicators 0 and 1 are always OFF.                   |  |           |          |               |

| SW3 | Description                       | Indicator  | Function |                   |
|-----|-----------------------------------|--|----------|-------------------|
| C   | Indicate the hour of the clock    | 0  | ----     |                   |
|     |                                   | 1  | ----     |                   |
|     |                                   | 2  | 2        | x 10 <sup>1</sup> |
|     |                                   | 3  | 1        |                   |
|     |                                   | 4  | 8        | x 10 <sup>0</sup> |
|     |                                   | 5  | 4        |                   |
|     |                                   | 6  | 2        |                   |
|     |                                   | 7  | 1        |                   |
| D   | Indicate the minutes of the clock | 0  | ----     |                   |
|     |                                   | 1  | 4        | x 10 <sup>1</sup> |
|     |                                   | 2  | 2        |                   |
|     |                                   | 3  | 1        |                   |
|     |                                   | 4  | 8        | x 10 <sup>0</sup> |
|     |                                   | 5  | 4        |                   |
|     |                                   | 6  | 2        |                   |
|     |                                   | 7  | 1        |                   |
| E   | Indicate the seconds of the clock | 0  | ----     |                   |
|     |                                   | 1  | 4        | x 10 <sup>1</sup> |
|     |                                   | 2  | 2        |                   |
|     |                                   | 3  | 1        |                   |
|     |                                   | 4  | 8        | x 10 <sup>0</sup> |
|     |                                   | 5  | 4        |                   |
|     |                                   | 6  | 2        |                   |
|     |                                   | 7  | 1        |                   |
| F   | Indicate the day of the week      | 0  | ----     |                   |
|     |                                   | 1  | ----     |                   |
|     |                                   | 2  | ----     |                   |
|     |                                   | 3  | ----     |                   |
|     |                                   | 4  | ----     |                   |
|     |                                   | 5  | 4        | x 10 <sup>0</sup> |
|     |                                   | 6  | 2        |                   |
|     |                                   | 7  | 1        |                   |
|     |                                   | Data: 00 to 23 (24-hour clock)<br>Indicators 0 and 1 are always OFF.   |          |                   |
|     |                                   | Data: 00 to 59 (minutes)<br>Indicator 0 is always OFF.   |          |                   |
|     |                                   | Data: 00 to 59 (seconds)<br>Indicator 0 is always OFF.   |          |                   |
|     |                                   | Data: 00 to 06<br>Indicators 0 through 4 are always OFF.<br>00: Sunday; 01: Monday; 02: Tuesday;<br>03: Wednesday; 04: Thursday; 05: Friday;<br>06: Saturday |          |                   |



## 2-2 Back Panel DIP Switch

The DIP switch on the back panel sets the operating conditions of the Unit. All pins are OFF at the time of delivery.

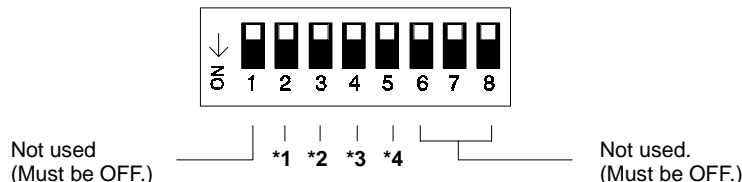

### \*1. PC Data Transfer

| 2   | Function   |
|-----|--|
| OFF | Data transfer between the PC and this Unit is the same as that for a standard 16-point I/O Unit.   |
| ON  | Data transfer between the PC and this Unit is carried out automatically via the I/O WRITE and I/O READ (WRIT(87)/READ(88)) instructions. |

### \*2. High-speed Inputs 1

| 3   | Function  |
|-----|---|
| OFF | Sets external input bits 0200 to 0203 for standard inputs.  |
| ON  | Sets external input bits 0200 to 0203 for high-speed inputs. A pulse width of 0.5 ms or longer can be received. |

### \*3. High-speed Inputs 2

| 4   | Function  |
|-----|---|
| OFF | Sets external input bits 0204 to 0207 for standard inputs.  |
| ON  | Sets external input bits 0204 to 0207 for high-speed inputs. A pulse width of 0.5 ms or longer can be received. |

### \*4. Independent Operation/Linked Operation

| 5   | Function   |
|-----|--|
| OFF | Operates in the same mode as the PC when the PC is in RUN or PROGRAM mode, but won't enter MONITOR mode. The Unit will be in RUN mode if the PC is in MONITOR mode. Front panel switches 4 and 5 are disabled. |
| ON  | Operating mode switched independently of PC operating mode. Switches 4 and 5 (front panel) determine operating mode.   |

- Note**
1. Refer to *Section 3 Data Areas* for information about PC data transfer.
  2. Refer to *Section 5 Program Execution Timing* for information about high-speed inputs 1 and 2.
  3. Refer to *Section 4 Programming* and *Appendix C Programming Instructions* for information about linked operation with the PC.

**Caution** If power is applied to the PC when pin 5 is OFF and the PC is set for RUN or MONITOR mode, the Ladder Program I/O Unit will automatically switch to RUN mode. If the Unit is communicating with the GPC, FIT, or LSS it will switch to RUN mode when the operation is completed.

# SECTION 3

## Data Areas

This section describes the data areas available for use in programming. The use of the I/O READ and I/O WRITE instructions are also described.

|       |                                       |    |
|-------|---------------------------------------|----|
| 3-1   | IR (Internal Relay) Area .....        | 14 |
| 3-1-1 | Normal I/O Operation .....            | 15 |
| 3-1-2 | Operation via WRIT(87)/READ(88) ..... | 16 |
| 3-2   | Work Bits .....                       | 17 |
| 3-3   | SR (Special Relay) Area .....         | 18 |
| 3-4   | TR (Temporary Relay) Bits .....       | 18 |
| 3-5   | TC (Timer/Counter) Area .....         | 18 |
| 3-6   | DM (Data Memory) Area .....           | 18 |

### 3-1 IR (Internal Relay) Area

| Data  | Word/bit address |    |  |
|---|------------------|----|--|
| 16 bits (0000 to 0015)<br>Output bits as seen from the PC | IR 00            |    | Input bits as seen from the Unit.<br>Cannot be used as work bits. The use of these bits depends on the setting of pin 2 of the back panel DIP switch. Refer to following subsections for details.  |
|   | 00               | 08 |  |
|   | 01               | 09 |  |
|   | 02               | 10 |  |
|   | 03               | 11 |  |
|   | 04               | 12 |  |
|   | 05               | 13 |  |
|   | 06               | 14 |  |
| 16 bits (0100 to 0115)<br>Input bits as seen from the PC  | IR 01            |    | Output bits as seen from the Unit.<br>Cannot be used as work bits. The use of these bits depends on the setting of pin 2 of the back panel DIP switch. Refer to following subsections for details. |
|   | 00               | 08 |  |
|   | 01               | 09 |  |
|   | 02               | 10 |  |
|   | 03               | 11 |  |
|   | 04               | 12 |  |
|   | 05               | 13 |  |
|   | 06               | 14 |  |
| 16 external input bits<br>(0200 to 0215)                  | IR 02            |    | Bits 0200 to 0207 can be set for high-speed inputs.<br>Cannot be used as work bits.  |
|   | 00               | 08 |  |
|   | 01               | 09 |  |
|   | 02               | 10 |  |
|   | 03               | 11 |  |
|   | 04               | 12 |  |
|   | 05               | 13 |  |
|   | 06               | 14 |  |
| 16 external output bits<br>(0300 to 0315)                 | IR 03            |    | Cannot be used as work bits.   |
|   | 00               | 08 |  |
|   | 01               | 09 |  |
|   | 02               | 10 |  |
|   | 03               | 11 |  |
|   | 04               | 12 |  |
|   | 05               | 13 |  |
|   | 06               | 14 |  |

### 3-1-1 Normal I/O Operation

When pin 2 of the back panel DIP switch is OFF, data is transferred through 2 words allocated for I/O. If pin 2 is OFF, data cannot be not transferred to and from the Ladder Program I/O Unit using the I/O WRITE and I/O READ (WRIT(87)/READ(88)) instructions from the PC.

The output bit data in PC word n (the first word allocated to the Unit by the PC) is input to word 00 in the Ladder Program I/O Unit. The bits of word 00 are treated as input bits when programming the Ladder Program I/O Unit.

The input bit data in PC word n+1 is output from word 01 in the Ladder Program I/O Unit. The bits of word 01 are treated as output bits when programming the Ladder Program I/O Unit.

| PC Word Allocation |               |              | Unit Word Allocation |              |               |
|--------------------|---------------|--------------|----------------------|--------------|---------------|
| Bit No.            | IR n          | IR n+1       | Bit No.              | Word 00      | Word 01       |
|                    | Output        | Input        |                      | Input        | Output        |
| 00                 | Output bit 00 | Input bit 00 | 00                   | Input bit 00 | Output bit 00 |
| 01                 | Output bit 01 | Input bit 01 | 01                   | Input bit 01 | Output bit 01 |
| 02                 | Output bit 02 | Input bit 02 | 02                   | Input bit 02 | Output bit 02 |
| 03                 | Output bit 03 | Input bit 03 | 03                   | Input bit 03 | Output bit 03 |
| 04                 | Output bit 04 | Input bit 04 | 04                   | Input bit 04 | Output bit 04 |
| 05                 | Output bit 05 | Input bit 05 | 05                   | Input bit 05 | Output bit 05 |
| 06                 | Output bit 06 | Input bit 06 | 06                   | Input bit 06 | Output bit 06 |
| 07                 | Output bit 07 | Input bit 07 | 07                   | Input bit 07 | Output bit 07 |
| 08                 | Output bit 08 | Input bit 08 | 08                   | Input bit 08 | Output bit 08 |
| 09                 | Output bit 09 | Input bit 09 | 09                   | Input bit 09 | Output bit 09 |
| 10                 | Output bit 10 | Input bit 10 | 10                   | Input bit 10 | Output bit 10 |
| 11                 | Output bit 11 | Input bit 11 | 11                   | Input bit 11 | Output bit 11 |
| 12                 | Output bit 12 | Input bit 12 | 12                   | Input bit 12 | Output bit 12 |
| 13                 | Output bit 13 | Input bit 13 | 13                   | Input bit 13 | Output bit 13 |
| 14                 | Output bit 14 | Input bit 14 | 14                   | Input bit 14 | Output bit 14 |
| 15                 | Output bit 15 | Input bit 15 | 15                   | Input bit 15 | Output bit 15 |

### 3-1-2 Operation via WRIT(87)/READ(88)

When pin 2 of the back panel DIP switch is ON, data can be transferred to and from the Ladder Program I/O Unit using the I/O WRITE and I/O READ (WRIT(87)/READ(88)) instructions from the PC. WRIT(87) and READ(88) are used automatically for this data transfer in the Ladder Program I/O Unit and are not available for user programming except in the PC. The Ladder Program I/O Unit must be mounted to the CPU Rack or Expansion I/O Rack of a PC that supports WRIT(87)/READ(88).

Data written by the WRIT(87) instruction in the PC program is stored in DM 064 through DM 095 in the Unit. A maximum of 32 words can be transferred. Data read by the READ(88) instruction in the PC is stored in DM 096 through DM 127. A maximum of 32 words of data can be read. The bits in parentheses are controlled automatically (as described below) when WRIT(87)/READ(88) are enabled. Treat these as read-only bits. The other input and output bits shown below can be used as normal I/O bits.

Do not output to word n with the MOV(21) instruction in the PC program. When outputting to word n, set the PC Busy, PC Write Completed, and PC Read Completed Flags to 0 (OFF). Also, do not output to word 01 with the MOV(21) instruction in the Ladder Program I/O Unit program. When outputting to word 01, set the I/O Busy, I/O Read End, I/O Write End, I/O Read OK, and I/O Write OK Flags to 0 (OFF).

Bit 0103 (the I/O Read OK Flag) is turned ON when data has been transferred correctly with the WRIT(87) instruction. It remains ON until the WRIT(87) instruction is executed again. Bit 0104 (the I/O Write OK Flag) is turned ON when data has been written from the Ladder Program I/O Unit. It is turned OFF when the READ(88) instruction is executed in the PC.

| PC Word Allocation |                     |                 | Unit Word Allocation |                     |                 |
|--------------------|---------------------|-----------------|----------------------|---------------------|-----------------|
| Bit No.            | IR n                | IR n+1          | Bit No.              | Word 00             | Word 01         |
|                    | Output              | Input           |                      | Input               | Output          |
| 00                 | (PC Busy)           | (I/O Busy)      | 00                   | (PC Busy)           | (I/O Busy)      |
| 01                 | (PC Write Complete) | (I/O Read End)  | 01                   | (PC Write Complete) | (I/O Read End)  |
| 02                 | (PC Read Complete)  | (I/O Write End) | 02                   | (PC Read Complete)  | (I/O Write End) |
| 03                 | Output bit 03       | (I/O Read Ok)   | 03                   | Input bit 03        | (I/O Read Ok)   |
| 04                 | Output bit 04       | (I/O Write Ok)  | 04                   | Input bit 04        | (I/O Write Ok)  |
| 05                 | Output bit 05       | Input bit 05    | 05                   | Input bit 05        | Output bit 05   |
| 06                 | Output bit 06       | Input bit 06    | 06                   | Input bit 06        | Output bit 06   |
| 07                 | Output bit 07       | Input bit 07    | 07                   | Input bit 07        | Output bit 07   |
| 08                 | Output bit 08       | Input bit 08    | 08                   | Input bit 08        | Output bit 08   |
| 09                 | Output bit 09       | Input bit 09    | 09                   | Input bit 09        | Output bit 09   |
| 10                 | Output bit 10       | Input bit 10    | 10                   | Input bit 10        | Output bit 10   |
| 11                 | Output bit 11       | Input bit 11    | 11                   | Input bit 11        | Output bit 11   |
| 12                 | Output bit 12       | Input bit 12    | 12                   | Input bit 12        | Output bit 12   |
| 13                 | Output bit 13       | Input bit 13    | 13                   | Input bit 13        | Output bit 13   |
| 14                 | Output bit 14       | Input bit 14    | 14                   | Input bit 14        | Output bit 14   |
| 15                 | Output bit 15       | Input bit 15    | 15                   | Input bit 15        | Output bit 15   |

### 3-2 Work Bits

Works bits are available for use in programming as required by the user. In the Ladder Program I/O Unit, work bits run from word 04 to word 12 and from bit 0400 to bit 1207, as shown below.

| Word/bit address |             |         |    |         |    |         |    |
|------------------|-------------|---------|----|---------|----|---------|----|
| Word 04          |             | Word 05 |    | Word 06 |    | Word 07 |    |
| 00               | 08          | 00      | 08 | 00      | 08 | 00      | 08 |
| 01               | 09          | 01      | 09 | 01      | 09 | 01      | 09 |
| 02               | 10          | 02      | 10 | 02      | 10 | 02      | 10 |
| 03               | 11          | 03      | 11 | 03      | 11 | 03      | 11 |
| 04               | 12          | 04      | 12 | 04      | 12 | 04      | 12 |
| 05               | 13          | 05      | 13 | 05      | 13 | 05      | 13 |
| 06               | 14          | 06      | 14 | 06      | 14 | 06      | 14 |
| 07               | 15          | 07      | 15 | 07      | 15 | 07      | 15 |
| Word 08          |             | Word 09 |    | Word 10 |    | Word 11 |    |
| 00               | 08          | 00      | 08 | 00      | 08 | 00      | 08 |
| 01               | 09          | 01      | 09 | 01      | 09 | 01      | 09 |
| 02               | 10          | 02      | 10 | 02      | 10 | 02      | 10 |
| 03               | 11          | 03      | 11 | 03      | 11 | 03      | 11 |
| 04               | 12          | 04      | 12 | 04      | 12 | 04      | 12 |
| 05               | 13          | 05      | 13 | 05      | 13 | 05      | 13 |
| 06               | 14          | 06      | 14 | 06      | 14 | 06      | 14 |
| 07               | 15          | 07      | 15 | 07      | 15 | 07      | 15 |
| Word 12          |             |         |    |         |    |         |    |
| 00               | Not usable. |         |    |         |    |         |    |
| 01               |             |         |    |         |    |         |    |
| 02               |             |         |    |         |    |         |    |
| 03               |             |         |    |         |    |         |    |
| 04               |             |         |    |         |    |         |    |
| 05               |             |         |    |         |    |         |    |
| 06               |             |         |    |         |    |         |    |
| 07               |             |         |    |         |    |         |    |

### 3-3 SR (Special Relay) Area

The following 16 bits are available for use in programming. Most of these are flags that can be read to determine program execution status or results. Bit 1304, the Carry Flag, is also manipulated by the user with STC(40) and CLC(41). Refer to descriptions of similar bits in the C500 Operation Manual for details.

| Bit address | Description  |
|-------------|--|
| 1208        | Always OFF   |
| 1209        | Turns ON for scans over 100 ms                                 |
| 1210        | Always OFF   |
| 1211        |  |
| 1212        |  |
| 1213        | Always ON  |
| 1214        | Always OFF   |
| 1215        | Turns ON for one scan time at the beginning of operation.      |
| 1300        | 0.1 sec clock pulse  |
| 1301        | 0.2 sec clock pulse  |
| 1302        | 1.0 sec clock pulse  |
| 1303        | Turns ON when the operational data is not BCD (ER flag).       |
| 1304        | Turns ON if the operational result produces a carry (CY flag). |
| 1305        | Turns ON if the operational result is greater (GR flag).       |
| 1306        | Turns ON if the operational result is equal to zero (EQ flag). |
| 1307        | Turns On if the operational result is less (LE flag).          |

### 3-4 TR (Temporary Relay) Bits

TR 0 through TR 7 can be used to store execution conditions at branches in ladder-diagram programs.

### 3-5 TC (Timer/Counter) Area

TC 00 through TC 15 can be used to define timers and counters in the program. Each TC number can be used only once to define a timer or counter.

### 3-6 DM (Data Memory) Area

The DM area contains 128 words between DM 000 and DM 127 and is used for storage of data by word. Although each word contains 16 bits, the DM area is accessible in word units only.

Clock data is assigned to DM 60 to 63; these words cannot be used for standard data. The clock can be set by writing data to these addresses in PROGRAM or MONITOR mode from a Programming Device or from the program. The clock is factory set to Sunday, January 1, year 00, 00:00:00. When power is applied, the clock starts at this time, and will continue timing for up to 10 days even if the power is cut off.

DM 064 through DM 127 are used for data transfer when pin 2 of the back panel DIP switch is turned ON (i.e., data transfer by the WRIT(87) and READ(88) instructions is enabled), and this region of the DM area cannot be used as normal DM words.

| DM address |     |     |     |     |     |     |     |
|------------|-----|-----|-----|-----|-----|-----|-----|
| 000        | 016 | 032 | 048 | 064 | 080 | 096 | 112 |
| 001        | 017 | 033 | 049 | 065 | 081 | 097 | 113 |
| 002        | 018 | 034 | 050 | 066 | 082 | 098 | 114 |
| 003        | 019 | 035 | 051 | 067 | 083 | 099 | 115 |
| 004        | 020 | 036 | 052 | 068 | 084 | 100 | 116 |
| 005        | 021 | 037 | 053 | 069 | 085 | 101 | 117 |
| 006        | 022 | 038 | 054 | 070 | 086 | 102 | 118 |
| 007        | 023 | 039 | 055 | 071 | 087 | 103 | 119 |
| 008        | 024 | 040 | 056 | 072 | 088 | 104 | 120 |
| 009        | 025 | 041 | 057 | 073 | 089 | 105 | 121 |
| 010        | 026 | 042 | 058 | 074 | 090 | 106 | 122 |
| 011        | 027 | 043 | 059 | 075 | 091 | 107 | 123 |
| 012        | 028 | 044 | 060 | 076 | 092 | 108 | 124 |
| 013        | 029 | 045 | 061 | 077 | 093 | 109 | 125 |
| 014        | 030 | 046 | 062 | 078 | 094 | 110 | 126 |
| 015        | 031 | 047 | 063 | 079 | 095 | 111 | 127 |

|        |     |     |     |     |     |     |     |     |     |     |     |     |     |     |     |     |
|--------|-----|-----|-----|-----|-----|-----|-----|-----|-----|-----|-----|-----|-----|-----|-----|-----|
| DM 000 | 15  | 14  | 13  | 12  | 11  | 10  | 09  | 08  | 07  | 06  | 05  | 04  | 03  | 02  | 01  | 00  |
| DM 001 | 15  | 14  | 13  | 12  | 11  | 10  | 09  | 08  | 07  | 06  | 05  | 04  | 03  | 02  | 01  | 00  |
| ...    | ... | ... | ... | ... | ... | ... | ... | ... | ... | ... | ... | ... | ... | ... | ... | ... |
| DM 126 | 15  | 14  | 13  | 12  | 11  | 10  | 09  | 08  | 07  | 06  | 05  | 04  | 03  | 02  | 01  | 00  |
| DM 127 | 15  | 14  | 13  | 12  | 11  | 10  | 09  | 08  | 07  | 06  | 05  | 04  | 03  | 02  | 01  | 00  |

#### Data Configuration in DM 060 to DM 127

| Word             | Bits 8 to 15  | Bits 0 to 7                                    |
|------------------|---|--|
| DM 060           | Minutes (0 to 59)   | Seconds (0 to 59)                              |
| DM 061           | Date (1 to 31)  | Hour (0 to 23)                                 |
| DM 062           | Calendar year (last two digits: 00 to 99)   | Month (1 to 12)                                |
| DM 063           | ---   | Day of the week (Sunday [00] to Saturday [06]) |
| DM 064 to DM 095 | <b>Back panel DIP switch pin 2 OFF:</b> Used as normal DM words.<br><b>Back panel DIP switch pin 2 ON:</b> Used to store data transferred by the WRIT(87) instruction in the PC, and therefore cannot be used as normal DM words. |  |
| DM 096 to DM 127 | <b>Back panel DIP switch pin 2 OFF:</b> Used as normal DM words.<br><b>Back panel DIP switch pin 2 ON:</b> Used as normal DM words, but the data stored here will be read out by READ(88) in the PC.                              |  |

- Note**
1. If incorrect data is written to words DM 060 through DM 063, a clock data write error will occur, and indicator 3 will flash.
  2. DM 064 through DM 095, which contain the data written from the PC in the WRIT(87) instruction, should be read only and not written to from the program.



# SECTION 4

## Programming

This section describes the programming operations possible from the Programming Devices and the operating modes. Writing the program is basically the same as writing a program for the PC, except that the instruction set is a bit smaller and the data areas differ. Refer to the *C500 Operation Manual* for details on writing the program and to *Appendix C Programming Instructions* for the instruction set that can be used with the Unit.

### 4-1 Program Addresses and Memory Capacity

Instructions vary in length from 1 to 17 bytes. Since each instruction requires one address, the maximum number of addresses available in a program also varies. The instructions along with the corresponding number of bytes required for each are listed in *Appendix C Programming instructions*.

The memory capacity available for the program is 4K and hence the approximate maximum number of instructions which can be programmed is 524 (based on an average length of 8 bytes per instruction).

### 4-2 Operating Modes

Any one of three modes, RUN mode, MONITOR (debug) mode, or PROGRAM mode, can be selected in this Unit.

#### RUN Mode

Only executes the program. Programming Devices cannot be connected in this mode, and the Unit scans and processes the program at high-speed. Select this mode for normal operation.

#### MONITOR Mode

Executes the program. Execution of the program is possible while Programming Devices are connected. The processing time is longer than that in RUN mode, because of the time required to process transmissions to and from the Programming Device. MONITOR mode is mainly used to debug new programs. Refer to the following pages in this section for information about operations that can be performed online in MONITOR mode.

#### PROGRAM Mode

Does not execute the program. Normally used to transfer or compare the program. Refer to the following pages in this section for information about operations that can be performed online in PROGRAM mode.

### 4-3 Changing the Operating Mode

The program can be transferred to the Ladder Program I/O Unit only when it is in PROGRAM mode. The table below shows the mode which the Unit will enter when the Unit is turned on or reset. The operating mode is controlled by the settings of pin 5 of the back panel DIP switch, switch 4 on the front of the Unit, and the status of the PC.

| SW4    | PC in RUN or MONITOR mode             |                                   | PC in PROGRAM mode                    |                                   |
|--------|---------------------------------------|-----------------------------------|---------------------------------------|-----------------------------------|
|        | Pin 5 ON:<br>Independent<br>Operation | Pin 5 OFF:<br>Linked<br>Operation | Pin 5 ON:<br>Independent<br>Operation | Pin 5 OFF:<br>Linked<br>Operation |
| Up     | RUN                                   | RUN                               | RUN                                   | PROGRAM                           |
| Center | MONITOR                               | MONITOR                           | MONITOR                               | PROGRAM                           |
| Down   | PROGRAM                               | RUN                               | PROGRAM                               | PROGRAM                           |

#### 4-3-1 Linked Operation

The operating mode of the Unit is linked to the operating mode of the PC. After the operating mode shown above is entered when the Unit is turned on or reset,

the operating mode of the Unit can be changed to RUN or MONITOR mode as long as the PC is in RUN or MONITOR mode. The operating mode cannot be changed to PROGRAM mode or when the PC is in PROGRAM mode. When the PC mode is changed, the operating mode is determined by switch 4.

**Switching to RUN Mode** First set switch 4 to the up position, then press and release switch 5. The Unit will enter RUN mode. (If switch 3 is set to 0, indicator 0 will light.)

**Switching to MONITOR Mode** First set switch 4 to the center position, then press and release switch 5. The Unit will enter MONITOR mode. (If switch 3 is set to 0, indicator 1 will light.)

## 4-3-2 Independent Operation

The operating mode can be changed arbitrarily. After the operating mode determined by switch 4 is entered when the Unit is turned on or reset, the operating mode can be changed as explained below.

**Switching to RUN Mode** First set switch 4 to the up position, then press and release switch 5. The Unit will enter RUN mode. (If switch 3 is set to 0, indicator 0 will light.)

**Switching to MONITOR Mode** First set switch 4 to the center position, then press and release switch 5. The Unit will enter MONITOR mode. (If switch 3 is set to 0, indicator 1 will light.)

**Switching to PROGRAM Mode** First set switch 4 to the down position, then press and release switch 5. The Unit will enter PROGRAM mode. (If switch 3 is set to 0, indicator 2 will light.)

- Note**
1. The operating mode cannot be changed from PROGRAM mode to MONITOR mode or RUN mode while the program is being transferred from a Programming Device. The operating mode can be changed when the program transfer has been completed.
  2. If an error occurs that stops the Unit, the operating mode will be switched to PROGRAM mode regardless of the setting of pin 5 of the back panel DIP switch. Refer to *6-1 Error Messages and Troubleshooting* regarding errors that stop operation.
  3. When switching from PROGRAM mode to MONITOR or RUN mode, or from MONITOR or RUN mode to PROGRAM mode, the I/O bits and work bits will be reset completely. The DM area will not be affected.

## 4-4 Programming Devices

Please use the GPC, FIT, or LSS for programming. The programming procedure for the Ladder Program I/O Unit is identical to that for C-series PCs. Refer to the *GPC, FIT, or LSS Operation Manual* for details.

|            |                        |                               |
|------------|------------------------|-------------------------------|
| <b>GPC</b> | Main unit              | 3G2C5-GPC03-E/3G2C5-GPC04-E   |
|            | System Memory Cassette | C500-MP303-EV2                |
|            | Operation Manual       | Catalog No. W84               |
| <b>FIT</b> | Main unit              | FIT10-SET11-E                 |
|            | Operation Manual       | Catalog No. W150              |
| <b>LSS</b> | Main unit              | C500-SF312-EV2/C500-SF711-EV2 |
|            | Operation Manual       | Catalog No. W113              |

## 4-5 Online Operations

Online operations between the Unit and the GPC/FIT/LSS are possible only in PROGRAM or MONITOR mode. They are not possible in RUN mode. Only those operations listed below are possible online.

## 4-5-1 Online Operations with the GPC

| Menu No. | Operation             |                                    | MONITOR | PROGRAM |
|----------|-----------------------|------------------------------------|---------|---------|
| —        | Connect/disconnect PC |                                    | Yes     | Yes     |
|          | Mode changes          |                                    | No      | No      |
| 0        | Monitoring            | Error readout                      | Yes     | Yes     |
|          |                       | Error clear                        | Yes     | Yes     |
|          |                       | Monitoring bit status              | Yes     | Yes     |
|          |                       | Monitoring I/O status              | Yes     | Yes     |
|          |                       | Force set/reset                    | Yes     | Yes     |
|          |                       | Change PV1                         | Yes     | Yes     |
|          |                       | Change PV2                         | Yes     | Yes     |
|          |                       | Change ASCII                       | Yes     | Yes     |
|          |                       | Multipoint I/O monitor             | Yes     | Yes     |
|          |                       | Word monitor                       | Yes     | Yes     |
|          |                       | Change TC PV                       | Yes     | Yes     |
|          |                       | Change TC SV1                      | No      | No      |
|          |                       | Change TC SV2                      | No      | No      |
|          |                       | Pause monitor display              | Yes     | Yes     |
|          |                       | Time chart monitoring              | Yes     | Yes     |
| 1        | I/O Table             | Generating                         | No      | No      |
|          |                       | Comparing                          | No      | No      |
|          |                       | Reading                            | No      | No      |
| 2        | User program transfer | PC memory clear                    | No      | Yes     |
|          |                       | Transfer (GPC to Unit)             | No      | Yes     |
|          |                       | Transfer (Unit to GPC)/Compare     | Yes     | Yes     |
| 3        | DM area transfer      | Transfer (GPC to Unit)             | Yes     | Yes     |
|          |                       | Transfer (Unit to GPC)/Compare     | Yes     | Yes     |
| 4        | Comment               | Transfer (GPC to factory computer) | No      | No      |
|          | memory                | Transfer (factory computer to GPC) | No      | No      |
|          | transfer              | Compare                            | No      | No      |

## 4-5-2 Online Operations with the FIT/LSS

The online operations that can be performed between the FIT/LSS and the Ladder Program I/O Unit are limited to monitoring and DM processes. Set the FIT/LSS as if connecting to a C500 PC. A "yes" indicates that the operation can be performed in this mode.

## Monitoring

| Operation                         | Application                        | MONITOR | PROGRAM |
|-----------------------------------|------------------------------------|---------|---------|
| Monitor I/O status                |                                    | Yes     | Yes     |
| Program transfer                  | Ladder Program I/O Unit to FIT/LSS | Yes     | Yes     |
|                                   | FIT/LSS to Ladder Program I/O Unit | Yes     | Yes     |
|                                   | Compare                            | Yes     | Yes     |
| Ladder diagram (without comments) |                                    | Yes     | Yes     |
| Ladder diagram (with comments)    |                                    | Yes     | Yes     |
| Online editing                    | Line connection                    | No      | No      |
|                                   | I/O comments                       | No      | No      |
|                                   | Line comments                      | No      | No      |
| Scan time read                    |                                    | No      | No      |
| Data area clear                   |                                    | No      | Yes     |
| Search                            |                                    | Yes     | Yes     |
| I/O comments                      |                                    | Yes     | Yes     |
| Line comments                     |                                    | Yes     | Yes     |
| Memory display                    |                                    | Yes     | Yes     |

## I/O Monitor Operations

| Operation       | MONITOR | PROGRAM |
|-----------------|---------|---------|
| Force Set/Reset | Yes     | Yes     |

## Basic Screen Function Keys

| Function  | MONITOR | PROGRAM |
|-----------|---------|---------|
| Release   | Yes     | Yes     |
| Set value | No      | No      |
| Stop      | Yes     | Yes     |

## Function Keys for Monitoring I/O

| Function       | MONITOR mode | PROGRAM mode |
|----------------|--------------|--------------|
| HEX:A          | Yes          | Yes          |
| Release        | No           | No           |
| Forced Release | No           | No           |
| Clear          | Yes          | Yes          |
| Change         | Yes          | Yes          |
| Stop           | Yes          | Yes          |

**Note** When checking TIM and TIMH(15) instructions with the ladder diagram monitor operation while in MONITOR mode, the observed timing might be longer than expected.

# SECTION 5

## Program Execution Timing

This section describes the internal processing of the CPU, include the program execution cycle, the instruction execution times, and the I/O response times. It also describes the operation of the high-speed inputs.

|       |  |    |
|-------|--|----|
| 5-1   | Operation in RUN and MONITOR Modes ..... | 28 |
| 5-2   | Scan Time .....                          | 28 |
| 5-3   | Instruction Execution Times .....        | 29 |
| 5-4   | I/O Response Time .....                  | 32 |
| 5-4-1 | Normal I/O Timing .....                  | 33 |
| 5-4-2 | High-speed Inputs .....                  | 34 |

## 5-1 Operation in RUN and MONITOR Modes

In RUN mode, the overseeing processes, program execution, and I/O refresh are repeated cyclically, as shown on the left below.

MONITOR mode processing is identical to RUN mode processing, but Programming Device servicing is performed after program execution, as shown in the flowchart on the right below. The processing time in MONITOR mode is much longer than that in RUN mode, because of the Programming Device servicing.

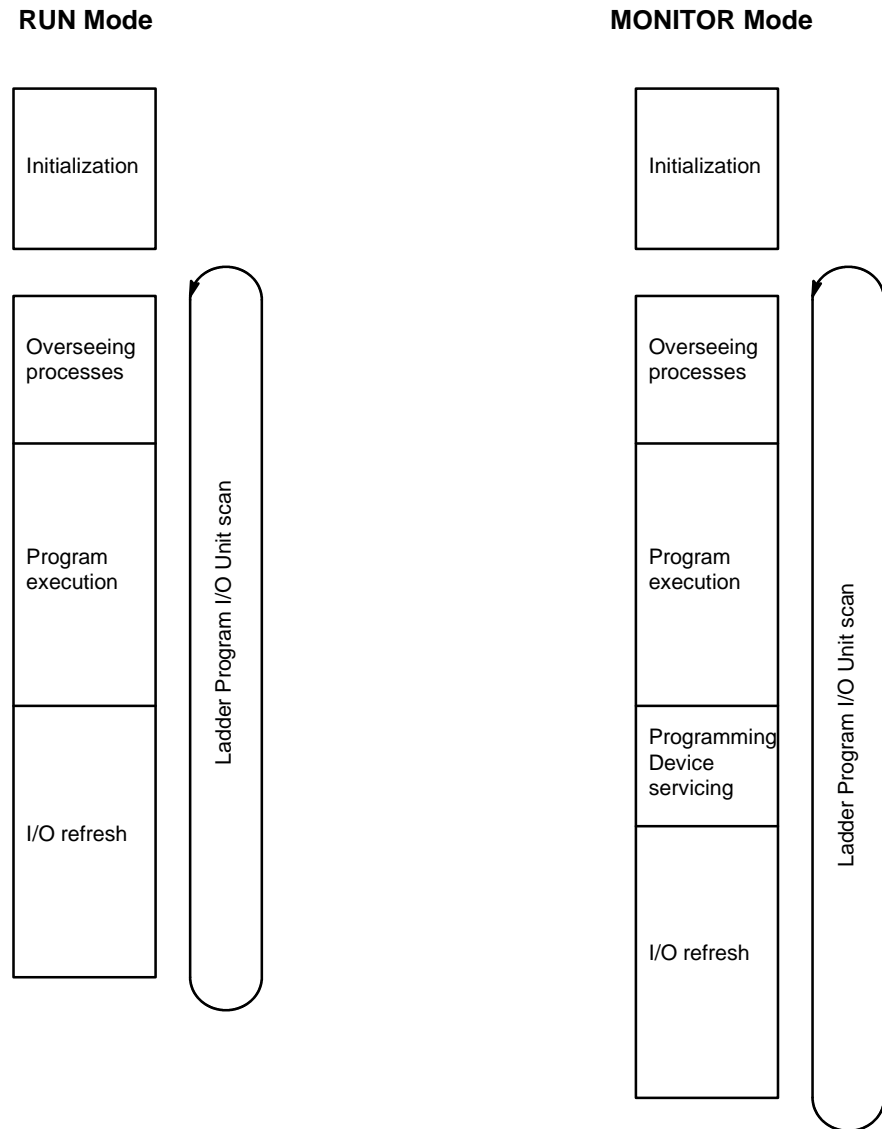

**Note** In MONITOR mode, data is transferred between the Ladder Program I/O Unit and the Programming Device during Programming Device servicing. The time required for Programming Device servicing varies depending on the processes performed, but the minimum time required is 20 ms.

## 5-2 Scan Time

It is important to know the scan time of the Unit in order to determine whether or not the program is operating correctly and to determine if I/O processing is timed properly.

The explanation below is for the scan time in RUN mode. The scan time will vary depending on the setting of pin 2 of the back panel DIP switch.

**Pin 2 ON (WRIT(87)/READ(88) Operation)**

Data is transferred to and from the PC using the I/O WRITE/READ (WRIT(87)/READ(88)) instructions.

**Pin 2 OFF (Normal I/O Operation)**

Data is transferred to and from the PC through 2 words allocated for I/O.

| Process           | Content   |   | Time requirements  |
|-------------------|---|---|--|
| Overseeing        | Watchdog timer set; indicators set, etc.  |   | 177 ms   |
| Program execution | Program executed.   |   | Total execution time for all instructions varies with program size, the instructions used, and execution conditions. Refer to <i>Instruction Execution Times</i> for details.                  |
| I/O refresh       | Pin 2 ON  | Pin 2 OFF   | Varies with the method of data transfer to/from the PC.<br><br>Input refresh: 47.50 ms<br>WRIT(87): 1.361 ms<br>Clock read/store: 192.50 ms<br>READ(88): 753.75 ms<br>Output refresh: 35.00 ms |
|                   | Input refresh<br>WRIT(87)<br>execution (see Note 2 below)<br>Clock read/store<br>READ(88)<br>execution (see Note 2 below)<br>Output refresh | Input refresh<br>Clock read/store<br>Output refresh |  |

**Scan time = Overseeing time + Program execution time + I/O refresh time**

- Note**
- The method of data transfer between the Unit and the PC is determined by the setting of pin 2 of the back panel DIP switch.  
The scan time is longer when pin 2 is ON, because of the time required to execute WRIT(87) and READ(88), but these instructions allow a large amount of data to be transferred all at once.
  - When WRIT(87) is executed during the I/O refresh, the data written from the PC is stored in DM 064 through DM 095 in the Unit.  
When READ(88) is executed, the data stored in DM 096 through DM 127 in the Unit is transferred to the PC.
  - The processing times given for the execution of WRIT(87) and READ(88) are the times required for the transfer of the maximum 32 words of data.

**Long Scan Times**

| Scan time (ms) | Possible adverse affects  |
|----------------|---|
| 10 or greater  | TIMH(15) inaccurate   |
| 100 or greater | A watchdog timer error occurs, operation stops, and the Unit is automatically switched to PROGRAM mode. |

**Note** If the scan time exceeds 100 ms, operation of the Unit is stopped and the Unit is automatically switched to PROGRAM mode. It is necessary to recheck the program at this point.

### 5-3 Instruction Execution Times

This following table lists the execution times for all instructions that are available for the Ladder Program I/O Unit. The maximum and minimum execution times and the conditions which cause them are given where relevant. When “word” is referred to in the Conditions column, it implies the content of PC I/O bits, external I/O bits, or work bits.

Execution times for instructions depend on whether they are executed with an ON or an OFF execution condition. The OFF execution time for an instruction can also vary depending on the circumstances, i.e., whether it is in an interlocked program section and the execution condition for IL is OFF or whether it is reset by an OFF execution condition. “When interlocked” and “When reset” are used to indicate these two times.

| Instruction | No. of bytes | Conditions  | ON execution time (μs)*<br>Top: Min.;<br>Bottom: Max. | OFF execution time (μs)*<br>Top: Min.; Bottom: Max. |                  |
|-------------|--------------|---|---|---|------------------|
| LD          | 8            | ---   | 6.875   | 5.625   |                  |
| LD NOT      | 8            | ---   | 6.875   | 5.625   |                  |
| AND         | 7            | ---   | 6.250   | 5.000   |                  |
| AND NOT     | 7            | ---   | 6.250   | 5.000   |                  |
| OR          | 7            | ---   | 6.250   | 5.000   |                  |
| OR NOT      | 7            | ---   | 6.250   | 5.000   |                  |
| AND LD      | 5            | ---   | 2.500   | 3.750   |                  |
| OR LD       | 5            | ---   | 3.750   | 2.500   |                  |
| OUT         | 14           | ---   | 11.250  | 6.875   |                  |
| OUT NOT     | 14           | ---   | 6.875   | 11.250  |                  |
| TIM         | 6            | Min: Constant for SV<br>Max: Word for SV                            | 126.875   | When reset  | When interlocked |
|             |              |   |   | 112.500   | 145.000          |
|             |              |   |   | 148.750   |                  |
| CNT         | 6            | Min: Constant for SV<br>Max: Word for SV                            | 111.875   | When reset  | When interlocked |
|             |              |   |   | 105.625   | 60.000           |
|             |              |   |   | 140.000   |                  |
| NOP(00)     | 1            | ---   | 0.625   | -   |                  |
| END(01)     | 6            | ---   | 1.875   | -   |                  |
| IL(02)      | 5            | ---   | 2.500   | 3.750   |                  |
| ILC(03)     | 2            | ---   | 1.250   | 1.250   |                  |
| JMP(04)     | 3            | ---   | 15.625  | 24.375  |                  |
| JME(05)     | 3            | Min: JMP(04) is not executed.                                       | 12.500  | ---   |                  |
|             |              | Max: JMP(04) is executed.   | 48.750  |   |                  |
| SFT(10)     | 6            | Min: With 1-word shift register<br>Max: With 10-word shift register | 100.625   | When reset  | When interlocked |
|             |              |   |   | 71.875  | 13.125           |
|             |              |   |   | 230.000   | 145.000          |
| KEEP(11)    | 17           | ---   | 13.750  | 2.500   |                  |
| CNTR(12)    | 6            | Min: Constant for SV<br>Max: Word for SV                            | 139.375   | When reset  | When interlocked |
|             |              |   |   | 105.000   | 56.875           |
| DIFU(13)    | 6            | ---   | 61.250  | With no OFF to ON transition                        | When interlocked |
|             |              |   |   | 69.375  | 47.500           |
| DIFD(14)    | 6            | ---   | 63.250  | With no ON to OFF transition                        | When interlocked |
|             |              |   |   | 71.250  | 49.375           |



| Instruction | No. of bytes | Conditions                                  | ON execution time (μs)*<br>Top: Min.;<br>Bottom: Max. | OFF execution time (μs)* |                  |
|-------------|--------------|---|---|--------------------------|------------------|
|             |              |   |   | Top: Min.;               | Bottom: Max.     |
| TIMH(15)    | 6            | Min: Constant for SV<br>Max: Word for SV    | 128.125   | When reset               | When interlocked |
|             |              |   |   | 113.750                  | 146.250          |
|             |              |   |   | 150.000                  |                  |
| WSFT(16)    | 10           | Min: When shifting 1 word                   | 110.000   | When reset               | When interlocked |
|             |              | Max: When shifting 128 words using DM       | 1.511 ms  | 29.375                   | 26.875           |
| CMP(20)     | 10           | Min: When comparing a constant to a word    | 98.750  | When reset               | When interlocked |
|             |              | Max: When comparing two TC                  | 195.625   | 29.375                   | 26.875           |
| MOV(21)     | 10           | Min: When transferring a constant to a word | 86.875  | When reset               | When interlocked |
|             |              | Max: When transferring TC to DM             | 148.125   | 29.375                   | 26.875           |
| MVN(22)     | 10           | Min: When transferring a constant to a word | 88.125  | When reset               | When interlocked |
|             |              | Max: When transferring TC to DM             | 149.375   | 29.375                   | 26.875           |
| BIN(23)     | 10           | Min: When converting a word to a word       | 116.875   | When reset               | When interlocked |
|             |              | Max: When converting TC to DM               | 136.250   | 29.375                   | 26.875           |
| BCD(24)     | 10           | Min: When converting a word to a word       | 110.000   | When reset               | When interlocked |
|             |              | Max: When converting TC to DM               | 149.375   | 29.375                   | 26.875           |
| ASL(25)     | 10           | Min: When shifting a word                   | 85.625  | When reset               | When interlocked |
|             |              | Max: When shifting DM                       | 89.375  | 29.375                   | 26.875           |
| ASR(26)     | 10           | Min: When shifting a word                   | 85.625  | When reset               | When interlocked |
|             |              | Max: When shifting DM                       | 89.375  | 29.375                   | 26.875           |
| ROL(27)     | 10           | Min: When rotating a word                   | 93.750  | When reset               | When interlocked |
|             |              | Max: When rotating DM                       | 97.500  | 29.375                   | 26.875           |
| ROR(28)     | 10           | Min: When rotating a word                   | 93.750  | When reset               | When interlocked |
|             |              | Max: When rotating DM                       | 97.500  | 29.375                   | 26.875           |
| COM(29)     | 10           | Min: When inverting a word                  | 78.125  | When reset               | When interlocked |
|             |              | Max: When inverting DM                      | 81.875  | 29.375                   | 26.875           |
| ADD(30)     | 10           | Min: Constant + word to word                | 211.875   | When reset               | When interlocked |
|             |              | Max: TC + TC to DM                          | 291.875   | 29.375                   | 26.875           |
| SUB(31)     | 10           | Min: Constant – word to word                | 217.500   | When reset               | When interlocked |
|             |              | Max: TC – TC to DM                          | 297.500   | 29.375                   | 26.875           |
| ANDW(34)    | 10           | Min: Constant AND word to word              | 123.125   | When reset               | When interlocked |
|             |              | Max: TC AND TC to DM                        | 231.250   | 29.375                   | 26.875           |
| ORW(35)     | 10           | Min: Constant OR word to word               | 123.125   | When reset               | When interlocked |
|             |              | Max: TC OR TC to DM                         | 231.250   | 29.375                   | 26.875           |
| XORW(36)    | 10           | Min: Constant XOR word to word              | 123.125   | When reset               | When interlocked |
|             |              | Max: TC XOR TC to DM                        | 231.250   | 29.375                   | 26.875           |
| XNRW(37)    | 10           | Min: Constant XNOR word to word             | 124.375   | When reset               | When interlocked |
|             |              | Max: TC XNOR TC to DM                       | 232.500   | 29.375                   | 26.875           |

| Instruction | No. of bytes | Conditions                          | ON execution time (μs)*<br>Top: Min.;<br>Bottom: Max. | OFF execution time (μs)*<br>Top: Min.; Bottom: Max. |                  |
|-------------|--------------|-------------------------------------|---|---|------------------|
|             |              |                                     |   |   |                  |
| INC(38)     | 10           | Min: When incrementing a word       | 112.500   | When reset  | When interlocked |
|             |              | Max: When incrementing DM           | 116.250   | 29.375  | 26.875           |
| DEC(39)     | 10           | Min: When decrementing a word       | 125.625   | When reset  | When interlocked |
|             |              | Max: When decrementing DM           | 129.375   | 29.375  | 26.875           |
| STC(40)     | 9            | ----                                | 9.375   | 5.000   |                  |
| CLC(41)     | 9            | ----                                | 9.375   | 5.000   |                  |
| SLD(74)     | 10           | Min: When shifting 1 word           | 75.000  | When reset  | When interlocked |
|             |              | Max: When shifting 128 DM words     | 5.276 ms  | 29.375  | 26.875           |
| SRD(75)     | 10           | Min: When shifting 1 word           | 73.750  | When reset  | When interlocked |
|             |              | Max: When shifting 128 DM words     | 5.274 ms  | 29.375  | 26.875           |
| MLPX(76)    | 10           | Min: When decoding a word to a word | 228.125   | When reset  | When interlocked |
|             |              | Max: When decoding TC to DM         | 495.000   | 29.375  | 26.875           |
| DMPX(77)    | 10           | Min: When encoding a word to a word | 300.625   | When reset  | When interlocked |
|             |              | Max: When encoding TC to DM         | 718.750   | 29.375  | 26.875           |

## 5-4 I/O Response Time

The Ladder Program I/O Unit reads input signals during the I/O refresh period, and then executes the program. The results from the program execution are then output at the next I/O refresh. The I/O response time thus depends upon the scan time, input ON delay, and output ON delay. Normally, only those high-speed inputs that occur during the I/O refresh are read.

When the high-speed inputs (I/O bits 0200 through 0207) are activated by turning on pins 3 and 4 of the back panel DIP switch, high-speed inputs that occur during the I/O refresh can also be read.

An explanation of normal I/O timing and high-speed input timing follows.

### 5-4-1 Normal I/O Timing

**Minimum I/O Response Time** The Unit responds most quickly when it receives an input signal just prior to I/O the refresh.

$$\text{Minimum I/O response time} = \text{input ON delay} + \text{scan time} + \text{output ON delay}$$

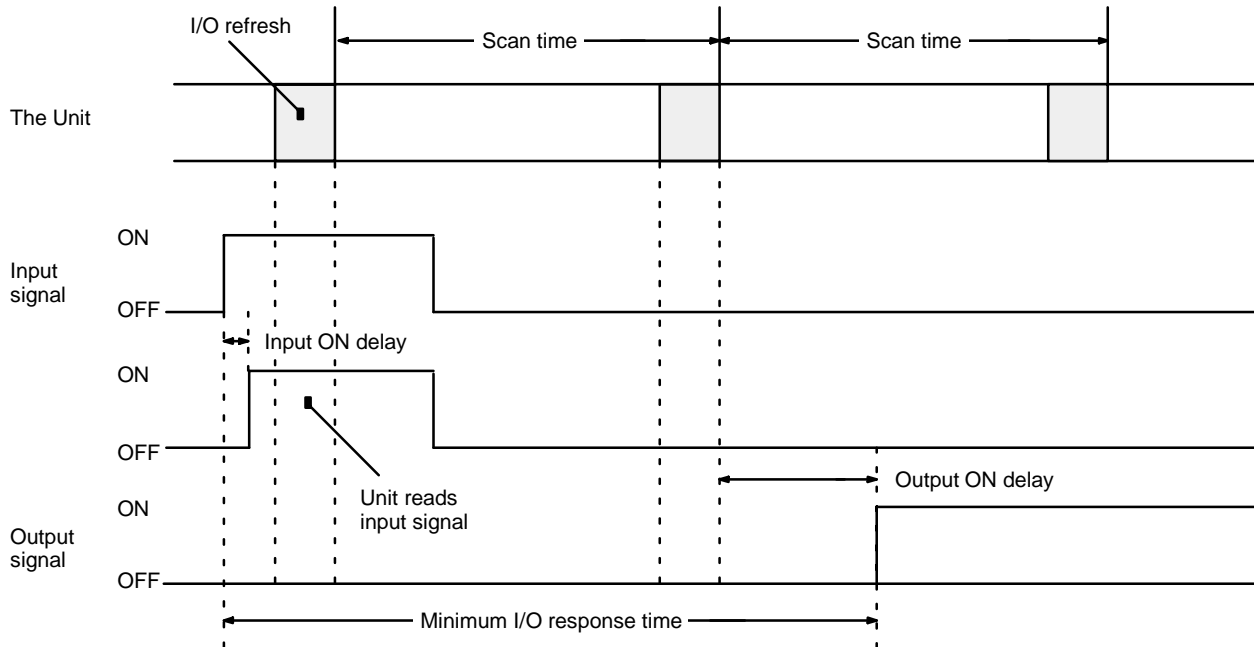

**Maximum I/O Response Time** The Unit takes the longest to respond when it receives an input signal just after the I/O refresh.

$$\text{Maximum I/O response time} = \text{input ON delay} + (\text{scan time} \times 2) + \text{output ON delay}$$

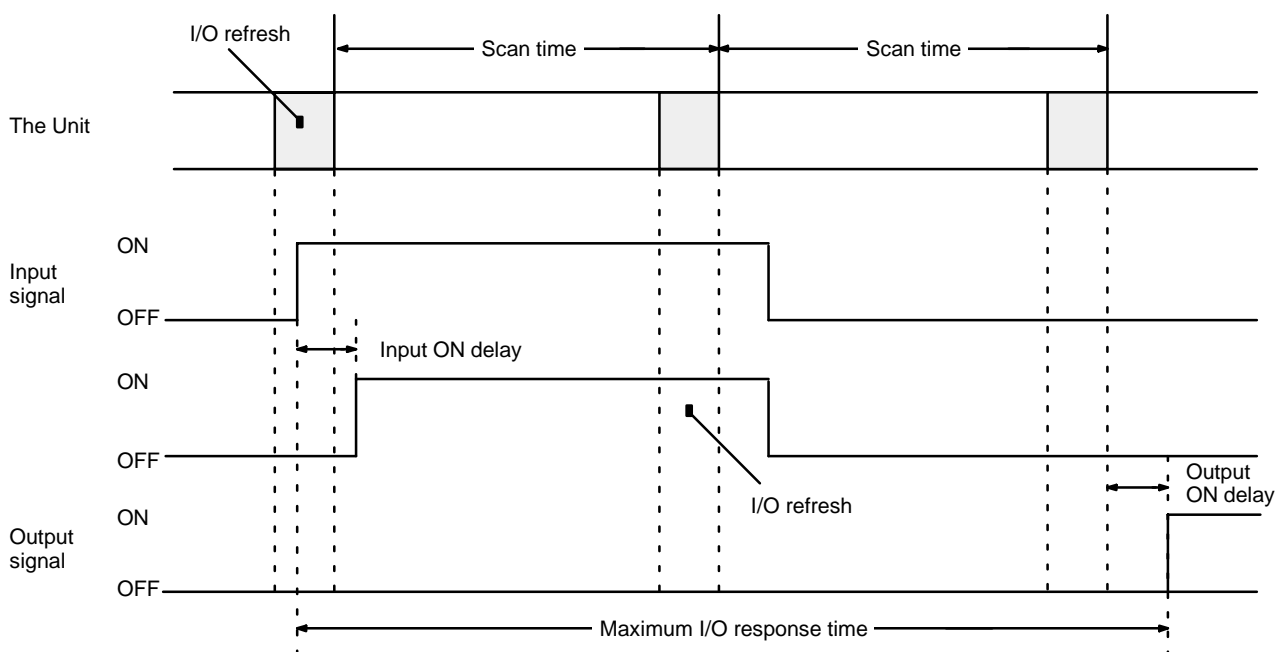

### 5-4-2 High-speed Inputs

High-speed inputs can be used by turning on pin 3 and/or pin 4 on the back panel DIP switch. Pin 3 enables high-speed inputs on IR 0200 through IR 0203; pin 4 on IR 0204 through IR 0207. When high-speed inputs are enabled, any pulse of 0.5 ms or longer will be acknowledged regardless of when it occurs, as shown below. The numbers in the following diagrams indicate processing as follows:

- 1, 2, 3...**
1. When a pulse is received that is 0.5 ms or longer, the high-speed input buffer is turned ON. The ON status is maintained until the next refresh period regardless of whether or not the input remains ON.
  2. When the next I/O refresh period is reached, the bit status is read from the high-speed input buffer to the input bit.
  3. If the input is OFF during the I/O refresh period, the high-speed input buffer is turned OFF after status has been read. If the input is still ON, the high-speed input buffer remains ON at least until the next I/O refresh period.
  4. Because the high-speed input buffer is reset if the input is OFF after reading status, the input bit is reset during the next I/O refresh period (unless the input has again come ON to activate the high-speed input buffer).

#### High-speed Inputs Between I/O Refresh Periods

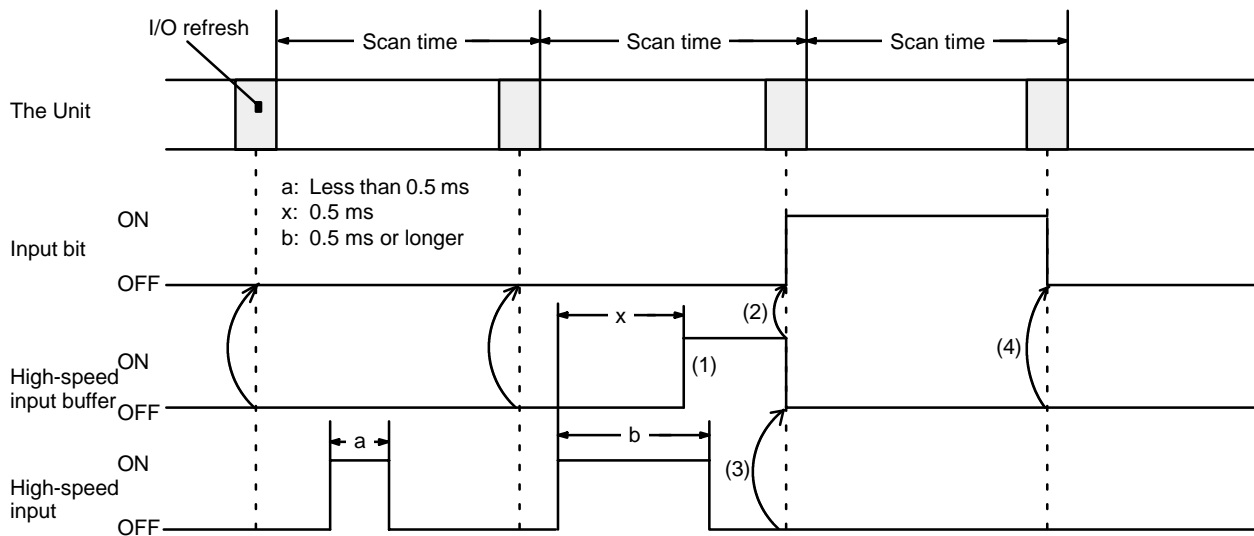

#### High-speed Input Continuing after I/O Refresh Period

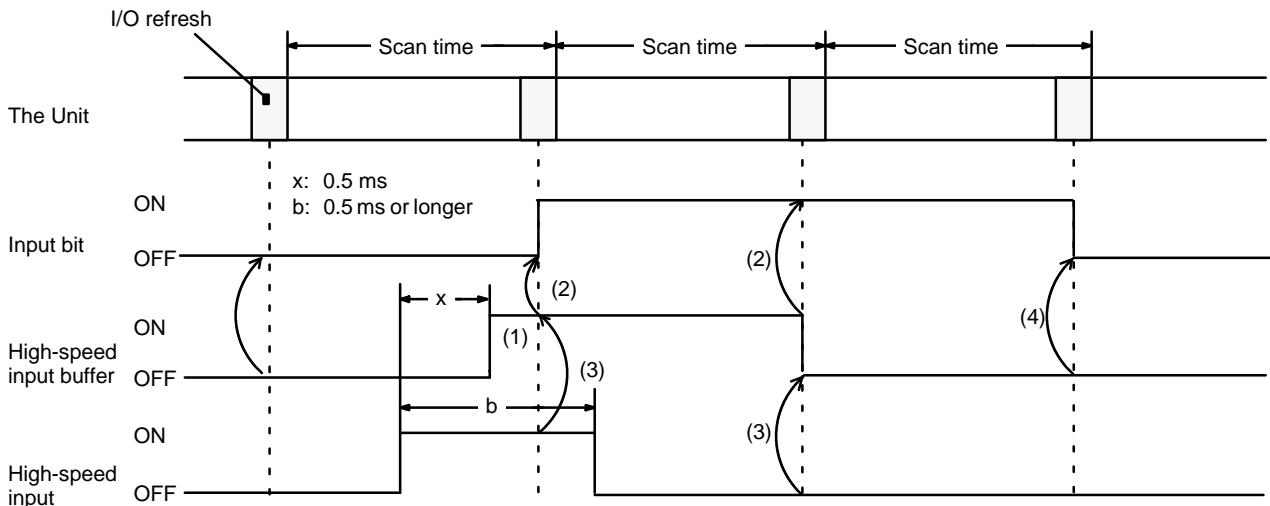

# SECTION 6

## Maintenance and Troubleshooting

This section provides error messages indicated by Unit indicators and troubleshooting steps. The procedure to replace the fuse inside the Unit is also provided.

|     |  |    |
|-----|--|----|
| 6-1 | Error Messages and Troubleshooting ..... | 36 |
| 6-2 | Maintenance .....                        | 37 |

## 6-1 Error Messages and Troubleshooting

| Error   | Possible Cause                              | Correction  |
|---|---|---|
| Indicators do not light   | PC power is OFF                             | Apply power to PC                                       |
|   | Unit is not mounted securely                | Mount Unit and tighten mounting screws                  |
| Indicator 4 lights during PROGRAM or MONITOR when SW 3 is set to 0 (GPC/FIT/LSS connection error) | GPC/FIT/LSS power is OFF                    | Apply power to the GPC/FIT/LSS                          |
|   | Cable to GPC/FIT/LSS is disconnected        | Reconnect the cable properly and secure with screws     |
|   | Broken cable or poor contact to GPC/FIT/LSS | Repair or replace the cable                             |
| Indicator 4 lights during RUN or MONITOR mode when SW 3 is set to 0 (operation continues)         | JMP(04) and JME(05) are not used in pairs   | Rewrite the program to use JMP(04) and JME(05) in pairs |
|   | Clock data read error                       | Reset clock data in PROGRAM mode                        |

### Fatal Errors

If an error occurs that stops the Unit, the indicator indicated in the following table will flash regardless of the setting of SW 3. Possible errors vary depending on which indicator flashes.

| Indicator | Error   | Possible Cause   | Correction   |
|-----------|---|--|--|
| 0         | Incorrect RAM (verified when power is connected or at reset time) | Failed RAM   | Replace Unit   |
|           | Incorrect EEPROM write  | Unable to write program to Unit                                  | Replace Unit   |
|           | Pin 1, 6, 7, or 8 set incorrectly                                 | Pin 1, 6, 7, or 8 set to ON                                      | Turn OFF pins 1, 6, 7, and 8   |
| 1         | Program error   | Program within Unit has been corrupted                           | Rewrite program. If error persists, replace Unit. Transfer data to the entire user program area. If transmission is interrupted after sending END(01), the write will be invalid; always write completely to end of program memory area. |
| 2         | No END instruction  | END(01) is missing in program                                    | Insert END(01) and retransfer the program  |
| 3         | Clock data write error  | Incorrect clock data written to DM 60 DM to 63                   | Write correct clock data   |
| 4         | Program conversion error  | Program contains an instruction which cannot be used in the Unit | Review program   |
|           |   | Program is too long and cannot be written to the Unit            |  |
| 5         | Too many jumps  | Program contains 10 or more JMP(04) instructions                 | Reduce jumps to 9 or less  |
| 6         | Too many DIFU(13)/DIFD(14)s                                       | Program contains 17 or more DIFU(13)/DIFD(14)s                   | Reduce DIFU(13)/DIFD(14)s to 16 or less  |
| 7         | CPU error   | Watchdog timer error has occurred                                | Review and correct program to limit scan time to 100 ms maximum  |

## 6-2 Maintenance

### Stand-by Unit

It is recommended to keep a stand-by Unit on hand at all times.

### Fuse Replacement

The Ladder Program I/O Unit uses two fuses; one for each eight outputs. Replace blown fuses, after eliminating the cause, with fuses of the following specifications:

125 V, 2 A (5.2 mm dia. x 20 mm)

Replace fuses according to the following procedure.

- 1, 2, 3... 1. Disconnect the PC power supply.
2. Remove input and output connectors.
3. Remove the Unit from the Backplane.
4. Remove the 8 cover mounting screws (4 on each side).
5. Remove the cover and circuit boards.
6. Replace the fuses.
7. To re-assemble, reverse the above procedure.

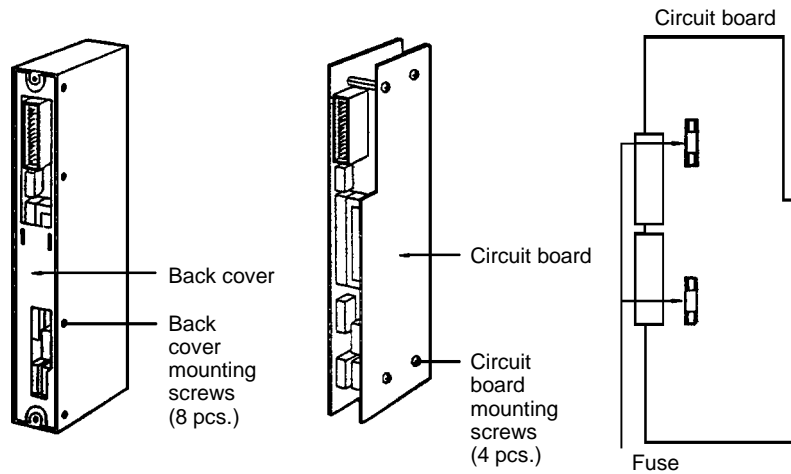

## Appendix A Standard Models

| Product Name            |                                   | Model No.                   |
|-------------------------|-----------------------------------|-----------------------------|
| Ladder Program I/O Unit |                                   | C500-LDP01-V1               |
| GPC                     | Main unit                         | 3G2C5-GPC03-E/3G2C5-GPC04-E |
|                         | System Memory Cassette            | C500-MP303-EV2              |
| FIT                     |                                   | FIT10-SET11-E               |
| LSS                     | 3 1/2" FD 720 KB (4 floppy disks) | C500-SF312-EV2              |
|                         | 5 1/4" FD 360 KB (8 floppy disks) | C500-SF711-EV2              |



# Appendix B

## Specifications

| Item  | Specification   |
|---|---|
| Words allocated in the PC                       | 2 words<br>The I/O WRITE and I/O READ (WRIT(87)/READ(88)) instructions can be used when enabled via a switch setting.   |
| Control method                                  | Stored program  |
| Main control element                            | MPU, C-MOS  |
| Programming                                     | Ladder diagram  |
| Instruction Length                              | 1 to 17 bytes/instruction   |
| Instructions                                    | 49 (basic instruction: 12/advanced instruction: 37)   |
| Processing time                                 | Typically 7 ms/step   |
| Program memory                                  | EEPROM 4 Kbytes   |
| Program length                                  | Approximately 524 addresses (variable depending on instructions used)   |
| I/O bits  | 64<br>16 PC output bits (0000 to 0015)<br>16 PC input bits (0100 to 0115)<br>16 external input bits (0200 to 0215)<br>16 external output bits (0300 to 0315)<br><br>External I/O bits 0200 to 0207 can be set as high-speed inputs in 2 groups of 4 each. |
| Work bits                                       | 136 total (0400 to 1207)  |
| Timers/counters                                 | 16 total<br>Timer: 0 to 999.9 s, accuracy $+0/-0.1$ s<br>TC 00 to TC 15<br>Counter: 0 to 9999 counts  |
| TR bits   | 8 total (TR 0 to TR 7)  |
| SR flags and bits                               | 16 total (1208 to 1307)   |
| Data memory                                     | 128 words (DM 000 through DM 127)<br>DM 060 through DM 063 are allocated for clock data.<br>DM 064 through DM 127 are dedicated to the I/O WRITE/READ (WRIT(87)/READ(88)) instructions when they are enabled.   |
| Power failure back-up functions                 | When power fails, the I/O bits, work bits, timers, counters, and the DM area will be cleared. The clock is backed up by a capacitor for approximately 10 days. Clock data is stored in the DM area from DM 60 to DM 63 when power is supplied.            |
| Block transfer capacity (via WRIT(87)/READ(88)) | Read/write area: 32 words<br>This function can be enabled or disabled with a switch setting.  |
| Diagnostic functions                            | CPU error (watchdog timer)<br>Memory error, etc.<br><br>Program Check<br>No END instruction<br>JMP-JME error<br>Too many DIFU/DIFD  |
| Internal current consumption                    | Maximum 800 mA 5 VDC  |
| Weight  | Maximum 600 g   |
| External dimensions (mm)                        | 34.5 x 250 x 93 mm (WxHxD)  |

# External Input/Output Specifications

## DC inputs

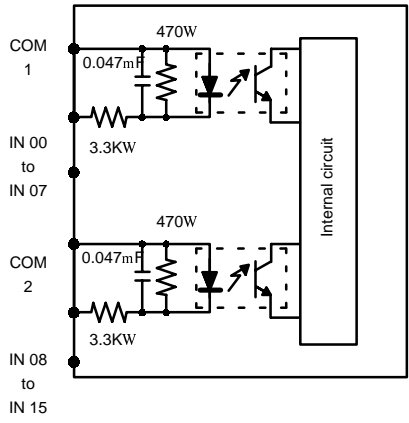
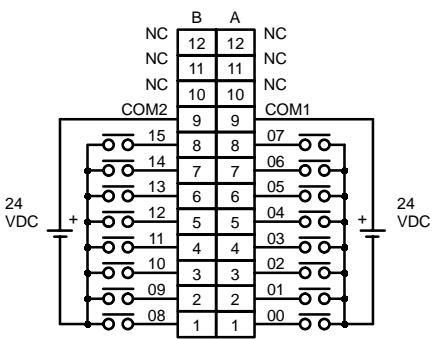
| Item                  | Specification   |
|-----------------------|---|
| Input voltage         | 24 VDC +10%/-15%  |
| Input impedance       | 3.3 kW  |
| Input current         | 7 mA typical (at 24 VDC)  |
| ON voltage            | Minimum 16.0 VDC  |
| OFF voltage           | Maximum 5.0 VDC   |
| ON response time      | Maximum 0.5 ms  |
| OFF response time     | Maximum 0.5 ms  |
| Number of circuits    | 16 points (8/common, 2 circuits)  |
| High-speed input      | 8 (input bits 0200 to 0207 when pins 3 and 4 of the DIP switch are set to ON)<br>0.5 ms minimum pulse width |
| Circuit configuration |                          |
| Wiring diagram        |                         |

Transistor Output

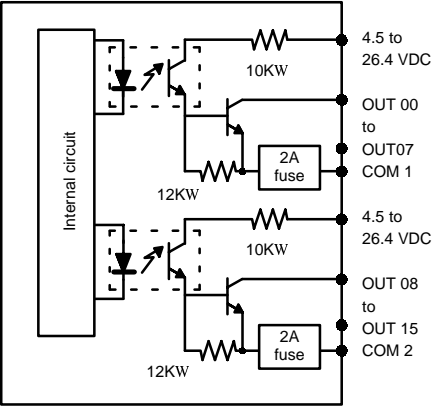
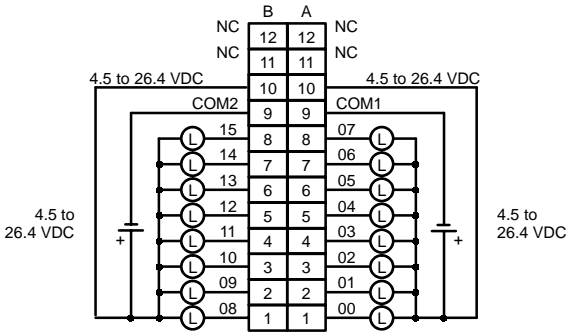
| Item                       | Specification  |
|----------------------------|--|
| Maximum switching capacity | 16 mA/4.5 VDC to 100 mA/26.4 VDC   |
| Current leakage            | Maximum 0.1 mA   |
| Residual voltage           | Maximum 0.4 V  |
| ON response time           | Maximum 0.2 ms   |
| OFF response time          | Maximum 0.3 ms   |
| Number of circuits         | 16 points (8/common, 2 circuits)   |
| Fuse                       | 2 A, 125 V (5.2 mm (dia.) x 20 mm) GG92  |
| External power supply      | 4.5 to 26.4 VDC, minimum 50 mA   |
| Circuit configuration      |   |
| Wiring diagram             |  |

### Maximum Switching Capacity of Transistor Outputs

The maximum switching capacity of transistor outputs, relative to the voltage of external output power supply, is shown below.

Special characteristics between maximum switching capacity and power supply voltage

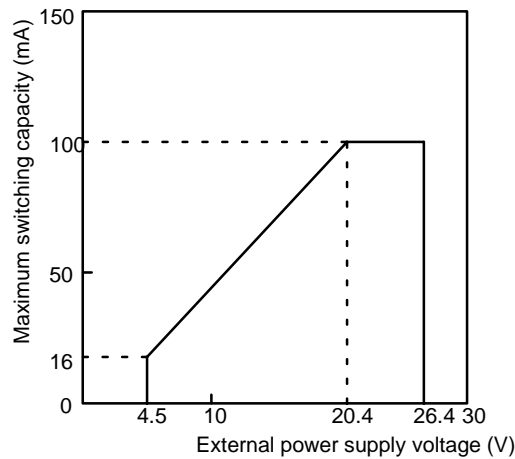

### I/O Connectors

During assembly, connect external inputs and outputs using the connectors included.

Although I/O connectors are identical in shape, the connections differ. Be certain to follow the labels when connecting.

Connectors on the Unit (Fujitsu)  
FCN-365P024-AU

- (1) FCN-361J024-AU (soldered) } 2 pieces
- FCN-360C024-B (connected cover) }
- (2) FCN-363J024 (solderless housing) } 2 sets each
- FCN-363J-AU (contact) }
- FCN-360C024-B (Connector cover) }
- (3) FCN-367J024-AU/F (pressure welded) 2 pieces

OMRON Connectors (OMRON supplies each as a set)

C500-CE241 (soldered)

C500-CE242 (solderless crimp type)

C500-CE243 (pressure-welded)

# Appendix C

## Programming Instructions

A PC instruction is input either by inputting the corresponding Programming Device key(s) (e.g., LD, AND, OR, NOT) or by using function codes. To input an instruction via its function code, press FUN, the function code, and then WRITE.

| Function Code | Name                   | Mnemonic | No. of bytes |
|---------------|------------------------|----------|--------------|
| --            | AND                    | AND      | 7            |
| --            | AND LOAD               | AND LD   | 5            |
| --            | AND NOT                | AND NOT  | 7            |
| --            | COUNTER                | CNT      | 6            |
| --            | LOAD                   | LD       | 8            |
| --            | LOAD NOT               | LD NOT   | 8            |
| --            | OR                     | OR       | 7            |
| --            | OR NOT                 | OR NOT   | 7            |
| --            | OR LOAD                | OR LD    | 5            |
| --            | OUTPUT                 | OUT      | 14           |
| --            | OUTPUT NOT             | OUT NOT  | 14           |
| --            | TIMER                  | TIM      | 6            |
| 00            | NO OPERATION           | NOP      | 1            |
| 01            | END                    | END      | 6            |
| 02            | INTERLOCK              | IL       | 5            |
| 03            | INTERLOCK CLEAR        | ILC      | 2            |
| 04            | JUMP                   | JMP      | 3            |
| 05            | JUMP END               | JME      | 3            |
| 10            | SHIFT REGISTER         | SFT      | 6            |
| 11            | KEEP                   | KEEP     | 17           |
| 12            | REVERSIBLE COUNTER     | CNTR     | 6            |
| 13            | DIFFERENTIATE UP       | DIFU     | 6            |
| 14            | DIFFERENTIATE DOWN     | DIFD     | 6            |
| 15            | HIGH-SPEED TIMER       | TIMH     | 6            |
| 16            | WORD SHIFT             | WSFT     | 10           |
| 20            | COMPARE                | CMP      | 10           |
| 21            | MOVE                   | MOV      | 10           |
| 22            | MOVE NOT               | MVN      | 10           |
| 23            | BCD-TO-BINARY          | BIN      | 10           |
| 24            | BINARY-TO-BCD          | BCD      | 10           |
| 25            | ARITHMETIC SHIFT LEFT  | ASL      | 10           |
| 26            | ARITHMETIC SHIFT RIGHT | ASR      | 10           |
| 27            | ROTATE LEFT            | ROL      | 10           |
| 28            | ROTATE RIGHT           | ROR      | 10           |
| 29            | COMPLEMENT             | COM      | 10           |
| 30            | BCD ADD                | ADD      | 10           |
| 31            | BCD SUBTRACT           | SUB      | 10           |
| 34            | AND WORD               | ANDW     | 10           |

| Function Code | Name                  | Mnemonic | No. of bytes |
|---------------|-----------------------|----------|--------------|
| 35            | OR WORD               | ORW      | 10           |
| 36            | EXCLUSIVE OR          | XORW     | 10           |
| 37            | EXCLUSIVE NOR         | XNRW     | 10           |
| 38            | INCREMENT             | INC      | 10           |
| 39            | DECREMENT             | DEC      | 10           |
| 40            | SET CARRY             | STC      | 9            |
| 41            | CLEAR CARRY           | CLC      | 9            |
| 74            | ONE DIGIT SHIFT LEFT  | SLD      | 10           |
| 75            | ONE DIGIT SHIFT RIGHT | SRD      | 10           |
| 76            | 4-TO-16 DECODER       | MLPX     | 10           |
| 77            | 16-TO-4 ENCODER       | DMPX     | 10           |

## Applicable Data Areas

The following table shows the addresses that can be used in each data area when programming. These are listed in the instruction tables by area. Any word/bit in the applicable areas can be designated as long as the end of the area is not exceeded, i.e., if two words are required for an operand, the last word in an area cannot be designated. In this respect, the IR, work bit, and SR area are considered as one consecutive area. Refer to the *C500 Operation Manual* for details. Indirect addressing is not possible for the Ladder Program I/O Unit.

| Prefix                          | Item                  | Word address                   | Bit address                                  |
|---------------------------------|-----------------------|--------------------------------|--|
| None (indicated with IR prefix) | PC output bits        | IR 00                          | IR 0000 to IR 0015                           |
|                                 | PC input bits         | IR 01                          | IR 0100 to IR 0115                           |
|                                 | External input bits   | IR 02                          | IR 0200 to IR 0215                           |
|                                 | External output bits  | IR 03                          | IR 0300 to IR 0315                           |
| None                            | Work bits             | 04 to 12                       | 0400 to 1207                                 |
| None (indicated with SR prefix) | SR bits               | 12 to 13                       | SR 1208 to SR 1307                           |
| TR                              | Temporary bits        | ---                            | TR 0 to TR 7                                 |
| TIM/CNT (indicated as TC)       | Timer/counter numbers | TC 00 to TC 15 (PV)            | TC 00 to TC 15 (defining or Completion Flag) |
| DM                              | Data memory           | DM 000 to DM 127               | ---  |
| #                               | Constants             | #0000 to 9999<br>#0000 to FFFF | ---  |

**Note** Data transferred by WRIT(87) and READ(88) instructions is stored in DM 064 through DM 127 when pin 2 of the back panel DIP switch is turned ON. If data will be transferred by the WRIT(87) and READ(88) instructions, DM 064 through DM 095 should be treated as read-only in the program. Refer to *3-6 DM Area* for details on the use of DM 060 through DM 127.

## Instruction Tables

The following tables list all of the ladder diagram programming instructions for the Ladder Program I/O Unit. These are all the same as corresponding instructions for the C500, except that data areas differ and not all C500 instructions are supported (see table at the end of this appendix). Refer to the *C500 Operation Manual* for details.

### Basic Instructions

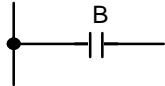
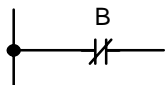
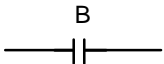
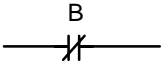
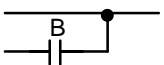
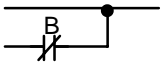
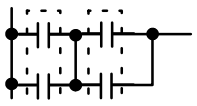

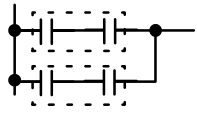
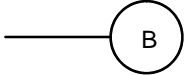
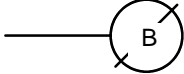
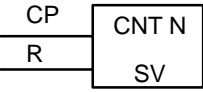
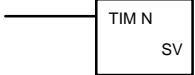
| Name and Mnemonic         | Symbol  | Function   | Operand Data Areas                             |
|---------------------------|---|--|--|
| <b>LOAD</b><br>LD         |    | Defines the status of bit B as the execution condition for subsequent operations in the instruction line.                | <b>B:</b><br>IR<br>SR<br>Work bits<br>TC<br>TR |
| <b>LOAD NOT</b><br>LD NOT |    | Defines the status of the inverse of bit B as the execution condition for subsequent operations in the instruction line. | <b>B:</b><br>IR<br>SR<br>Work bits<br>TC       |
| <b>AND</b><br>AND         |   | Logically ANDs the status of the designated bit with the current execution condition.                                    | <b>B:</b><br>IR<br>SR<br>Work bits<br>TC       |
| <b>AND NOT</b><br>AND NOT |  | Logically ANDs the inverse of the designated bit with the current execution condition.                                   | <b>B:</b><br>IR<br>SR<br>Work bits<br>TC       |
| <b>OR</b><br>OR           |  | Logically ORs the status of the designated bit with the current execution condition.                                     | <b>B:</b><br>IR<br>SR<br>Work bits<br>TC       |
| <b>OR NOT</b><br>OR NOT   |  | Logically ORs the inverse of the designated bit with the execution condition.  | <b>B:</b><br>IR<br>SR<br>Work bits<br>TC       |
| <b>AND LOAD</b><br>AND LD |  | Logically ANDs the resultant execution conditions of the preceding logic blocks.   | None   |

| Name and Mnemonic            | Symbol  | Function  | Operand Data Areas  |
|------------------------------|---|---|---|
| <b>OR LOAD</b><br>OR LD      |    | Logically ORs the resultant execution conditions of the preceding logic blocks.   | None  |
| <b>OUTPUT</b><br>OUT         |    | Turns ON B for an ON execution condition; turns OFF B for an OFF execution condition.   | <b>B:</b><br>IR (except IR 00 and IR 02)<br>Work bits<br>TR |
| <b>OUTPUT NOT</b><br>OUT NOT |    | Turns OFF B for an ON execution condition; turns ON B for an OFF execution condition.   | <b>B:</b><br>IR (except IR 00 and IR 02)<br>Work bits       |
| <b>COUNTER</b><br>CNT        |    | A decrementing counter. SV: 0 to 9999; CP: count pulse; R: reset input. The TC bit is entered as a constant.  | <b>N:</b><br>TC<br><b>SV:</b><br>IR<br>SR<br>Work bits<br># |
| <b>TIMER</b><br>TIM          |  | ON-delay (decrementing) timer operation. Set value: 000.0 to 999.9 s. The same TC bit cannot be assigned to more than one timer/counter. The TC bit is entered as a constant. | <b>N:</b><br>TC<br><b>SV:</b><br>IR<br>SR<br>Work bits<br># |



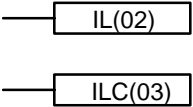
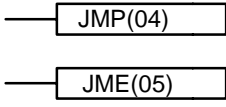
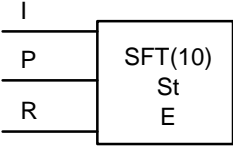
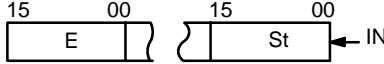
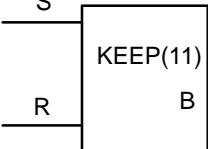
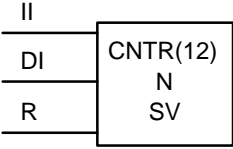

## Special Instructions

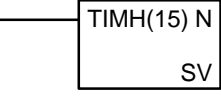
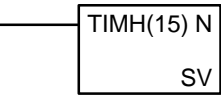

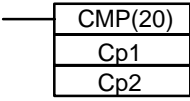
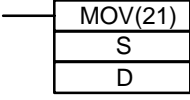
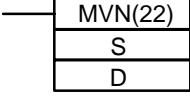
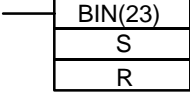
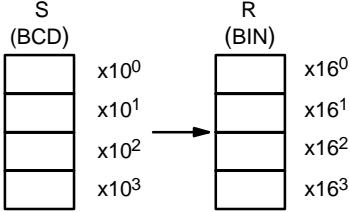
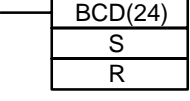
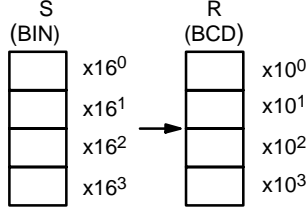
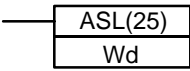
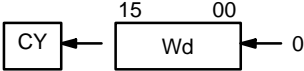
| Name Mnemonic                  | Symbol  | Function  | Operand Data Areas |
|--------------------------------|---|---|--------------------|
| <b>NO OPERATION</b><br>NOP(00) | None  | Nothing is executed and program operation moves to the next instruction.                      | None               |
| <b>END</b><br>END(01)          |  | Required at the end of each program. Instructions located after END(01) will not be executed. | None               |

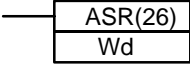
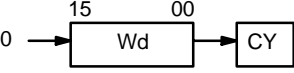
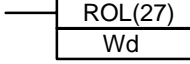
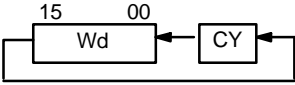
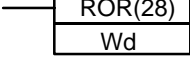
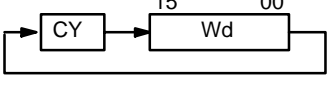
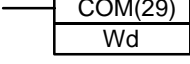
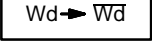
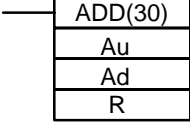

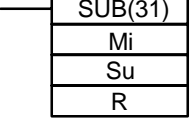
| Name<br>Mnemonic   | Symbol  | Function  | Operand Data Areas  |
|--|---|---|---|
| <b>INTERLOCK</b><br>IL(02)<br><b>INTERLOCK</b><br><b>CLEAR</b><br>ILC(03)                        |    | If an interlock condition is OFF, all outputs and all timer PVs between the current IL(02) and the next ILC(03) are turned OFF or reset, respectively. Other instructions are treated as NOP. Counter PVs are maintained. If the execution condition is ON, execution continues normally. | None  |
| <b>JUMP</b><br>JMP(04)<br><b>JUMP END</b><br>JME(05)   |    | When the execution condition for the JMP(04) instruction is ON, all instructions between JMP(04) and the next JME(05) are ignored or treated as NOP(00)   | None  |
| <b>SHIFT REGISTER</b><br>SFT(10)   | <br> | Creates a bit shift register for data from the starting word (St) through to the ending word (E). I: input bit; P: shift pulse; R: reset input. St must be less than or equal to E. St and E must be in the same data area.   | <b>St/E:</b><br>IR (except IR00 and IR02)<br>Work bits (except word 12) |
| <b>KEEP</b><br>KEEP(11)  |   | Defines a bit (B) as a latch, controlled by the set (S) and reset (R) inputs.   | <b>B:</b><br>IR (except IR00 and IR02)<br>Work bits                     |
| <b>REVERSIBLE</b><br><b>COUNTER</b><br>CNTR (12)   |    | Increases or decreases the PV by one whenever the increment input (II) or decrement input (DI) signals, respectively, go from OFF to ON. SV: 0 to 9999; R: reset input. Each TC bit can be used for one timer/counter only. The TC bit is entered as a constant.                          | <b>N:</b> TC<br><b>SV:</b> IR, SR, Work bits, #                         |
| <b>DIFFERENTIATE</b><br><b>UP</b><br>DIFU(13)<br><b>DIFFERENTIATE</b><br><b>DOWN</b><br>DIFD(14) |    | DIFU(13) turns ON the designated bit (B) for one scan on reception of the leading (rising) edge of the input signal; DIFD(14) turns ON the bit for one scan on reception of the trailing (falling) edge. A maximum of 16 DIFFERENTIATE UP/DOWN instructions can be used                   | <b>B:</b><br>IR (except IR00 and IR02)<br>Work bits                     |
| <b>HIGH-SPEED</b><br><b>TIMER</b><br>TIMH(15)  |    | A high-speed, ON-delay (decrementing) timer. SV: 00.02 to 99.99 s. Each TC bit can be assigned to only one timer or counter. The TC bit is entered as a constant.   | <b>N:</b> TC<br><b>SV:</b> IR, SR, Work bits, #                         |
| <b>WORD SHIFT</b><br>WSFT(16)  |    | The data in the words from the starting word (St) through to the ending word (E), is shifted left in word units, writing all zeros into the starting word. St must be less than or equal to E, and St and E must be in the same data area.  | <b>St/E:</b><br>IR<br>Work bits (except word 12)                        |

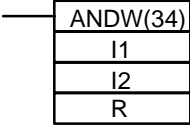
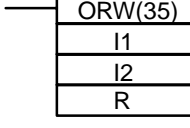
| Name<br>Mnemonic                        | Symbol  | Function  | Operand Data Areas  |   |
|---|---|---|---|---|
| <b>COMPARE</b><br>CMP(20)               |    | Compares the data in two 4-digit hexadecimal words (Cp1 and Cp2) and outputs result to the GR, EQ, or LE Flags.   | <b>Cp1/Cp2:</b><br>IR<br>SR<br>Work bits<br>TC<br>DM<br># |   |
| <b>MOVE</b><br>MOV(21)                  |    | Transfers data from source word, (S) to destination word (D).   | <b>S:</b><br>IR<br>SR<br>Work bits<br>TC<br>DM<br>#       | <b>D:</b><br>IR<br>Work bits (except word 12)<br>DM |
| <b>MOVE NOT</b><br>MVN(22)              |    | Transfers the inverse of the data in the source word (S) to destination word (D).   | <b>S:</b><br>IR<br>SR<br>Work bits<br>TC<br>DM<br>#       | <b>D:</b><br>IR<br>Work bits (except word 12)<br>DM |
| <b>BCD TO BINARY</b><br>BIN(23)         |   | Converts 4-digit, BCD data in source word (S) into 16-bit binary data, and outputs converted data to result word (R).<br><br>           | <b>S:</b><br>IR<br>SR<br>Work bits<br>TC<br>DM            | <b>R:</b><br>IR<br>Work bits (except word 12)<br>DM |
| <b>BINARY TO BCD</b><br>BCD(24)         |  | Converts binary data in source word (S) into BCD, and outputs converted data to result word (R).<br><br>                                | <b>S:</b><br>IR<br>SR<br>Work bits<br>DM                  | <b>R:</b><br>IR<br>Work bits (except word 12)<br>DM |
| <b>ARITHMETIC SHIFT LEFT</b><br>ASL(25) |  | Each bit within a single word of data (Wd) is shifted one bit to the left, with zero written to bit 00 and bit 15 moving to CY.<br><br> | <b>Wd:</b><br>IR<br>Work bits (except word 12)<br>DM      |   |

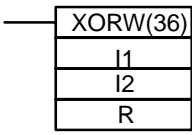
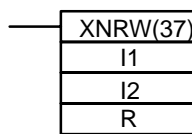
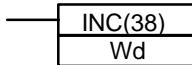
| Name<br>Mnemonic                             | Symbol  | Function   | Operand Data Areas   |
|--|---|--|--|
| <b>ARITHMETIC<br/>SHIFT RIGHT</b><br>ASR(26) |    | <p>Each bit within a single word of data (Wd) is shifted one bit to the right, with zero written to bit 15 and bit 00 moving to CY.</p>                                | <b>Wd:</b><br>IR<br>Work bits (except word 12)<br>DM   |
| <b>ROTATE LEFT</b><br>ROL(27)                |    | <p>Each bit within a single word of data (Wd) is moved one bit to the left, with bit 15 moving to carry (CY), and CY moving to bit 00.</p>                             | <b>Wd:</b><br>IR<br>Work bits (except word 12)<br>DM   |
| <b>ROTATE RIGHT</b><br>ROR(28)               |    | <p>Each bit within a single word of data (Wd) is moved one bit to the right, with bit 00 moving to carry (CY), and CY moving to bit 15.</p>                            | <b>Wd:</b><br>IR<br>Work bits (except word 12)<br>DM   |
| <b>COMPLEMENT</b><br>COM(29)                 |    | <p>Inverts bit status of one word (Wd) of data, changing 0s to 1s, and vice versa.</p>    | <b>Wd:</b><br>IR<br>Work bits (except word 12)<br>DM   |
| <b>BCD ADD</b><br>ADD(30)                    |  | <p>Adds two 4-digit BCD values (Au and Ad) and content of CY, and outputs the result to the specified result word (R).</p>   | <b>Au/Ad:</b><br>IR<br>SR<br>Work bits<br>TC<br>DM<br>#<br><b>R:</b><br>IR<br>Work bits (except word 12)<br>DM |
| <b>BCD SUBTRACT</b><br>SUB(31)               |  | <p>Subtracts both the 4-digit BCD subtrahend (Su) and content of CY, from the 4-digit BCD minuend (Mi) and outputs the result to the specified result word (R).</p>  | <b>Mi/Su:</b><br>IR<br>SR<br>Work bits<br>TC<br>DM<br>#<br><b>R:</b><br>IR<br>Work bits (except word 12)<br>DM |
| <b>AND WORD</b><br>ANDW(34)                  |  | <p>Logically ANDs two 16-bit input words (I1 and I2) and sets the bits in the result word (R) if the corresponding bits in the input words are both ON.</p>  | <b>I1/I2:</b><br>IR<br>SR<br>Work bits<br>TC<br>DM<br>#<br><b>R:</b><br>IR<br>Work bits (except word 12)<br>DM |
| <b>OR WORD</b><br>ORW(35)                    |  | <p>Logically ORs two 16-bit input words (I1 and I2) and sets the bits in the result word (R) when one or both of the corresponding bits in the input words is/are ON.</p>  | <b>I1/I2:</b><br>IR<br>SR<br>Work bits<br>TC<br>DM<br>#<br><b>R:</b><br>IR<br>Work bits (except word 12)<br>DM |

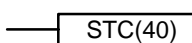
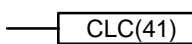
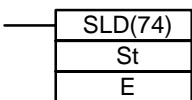
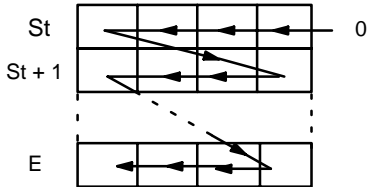
| Name<br>Mnemonic                       | Symbol  | Function  | Operand Data Areas   |
|--|---|---|--|
| <b>EXCLUSIVE OR</b><br>XORW(36)        |    | Exclusively ORs two 16-bit input words (I1 and I2) and sets the bits in the result word (R) when the corresponding bits in input words differ in status.  | <b>I1/I2:</b><br>IR<br>SR<br>Work bits<br>TC<br>DM<br>#<br><b>R:</b><br>IR<br>Work bits (except word 12)<br>DM |
| <b>EXCLUSIVE NOR</b><br>XNRW(37)       |    | Exclusively NORs two 16-bit input words (I1 and I2) and sets the bits in the result word (R) when the corresponding bits in both input words have the same status.  | <b>I1/I2:</b><br>IR<br>SR<br>Work bits<br>TC<br>DM<br>#<br><b>R:</b><br>IR<br>Work bits (except word 12)<br>DM |
| <b>INCREMENT</b><br>INC(38)            |    | Increments the value of a 4-digit BCD word (Wd) by one, without affecting carry (CY).   | <b>Wd:</b><br>IR<br>Work bits (except word 12)<br>DM   |
| <b>DECREMENT</b><br>DEC(39)            |   | Decrements the value of a 4-digit BCD word by 1, without affecting carry (CY).  | <b>Wd:</b><br>IR<br>Work bits (except word 12)<br>DM   |
| <b>SET CARRY</b><br>STC(40)            |  | Sets the Carry Flag (i.e., turns CY ON).  | None   |
| <b>CLEAR CARRY</b><br>CLC(41)          |  | Clears the Carry Flag (i.e, turns CY OFF).  | None   |
| <b>ONE DIGIT SHIFT LEFT</b><br>SLD(74) |  | Shifts all data, between the starting word (St) and ending word (E), one digit (four bits) to the left, writing zero into the rightmost digit of the starting word. St and E must be in the same data area.<br><br> | <b>St/E:</b><br>IR<br>Work bits (except word 12)<br>DM   |

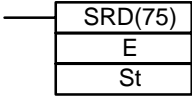
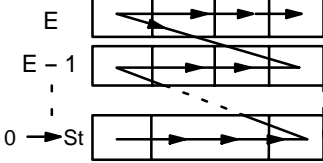
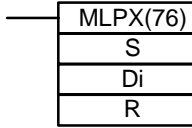
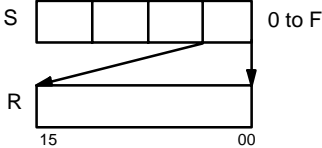
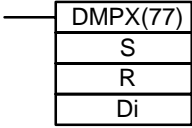
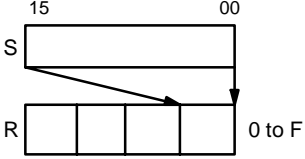
| Name<br>Mnemonic                            | Symbol  | Function   | Operand Data Areas   |
|---|---|--|--|
| <b>ONE DIGIT SHIFT<br/>RIGHT</b><br>SRD(75) |    | <p>Shifts all data, between starting word (St) and ending word (E), one digit (four bits) to the right, writing zero into the leftmost digit of the ending word. St and E must be in the same data area.</p>   | <b>St/E:</b><br>IR<br>Work bits (except word 12)<br>DM   |
| <b>4-TO-16<br/>DECODER</b><br>MLPX(76)      |    | <p>Converts up to four hexadecimal digits in the source word (S), into decimal values from 0 to 15, and turns ON the corresponding bit(s) in the result word(s) (R). There is one result word for each converted digit. Digits to be converted are designated by Di. (The rightmost digit specifies the first digit. The next digit to the left gives the number of digits to be converted minus 1. The two leftmost digits are not used.)</p>              | <b>S:</b><br>IR<br>SR<br>Work bits<br>TC<br>DM<br><br><b>Di:</b><br>IR<br>Work bits (except word 12)<br>TC<br>DM<br>#<br><br><b>R:</b><br>IR<br>Work bits (except word 12)<br>DM |
| <b>16-TO-4<br/>ENCODER</b><br>DMPX(77)      |  | <p>Determines the position of the leftmost ON bit in the source word(s) (starting word: S) and turns ON the corresponding bit(s) in the specified digit of the result word (R). One digit is used for each source word. Digits to receive the converted values are designated by Di. (The rightmost digit specifies the first digit. The next digit to left gives the number of words to be converted minus 1. The two leftmost digits are not used.)</p>  | <b>S:</b><br>IR<br>SR<br>Work bits<br>TC<br>DM<br><br><b>R:</b><br>IR<br>Work bits (except word 12)<br>DM<br><br><b>Di:</b><br>IR<br>Work bits (except word 12)<br>TC<br>DM<br># |

## Unsupported Instructions

The following C500 instructions are not supported by the Ladder Programming I/O Unit and will be treated as NOP if used. WRIT(87) and READ(88) are used internally only and cannot be programmed by the user in the Ladder Program I/O Unit.

| Name                      | Mnemonic |
|---------------------------|----------|
| FAILURE ALARM             | FAL(06)  |
| SEVERE FAILURE ALARM      | FALS(07) |
| BCD MULTIPLY              | MUL(32)  |
| BCD DIVIDE                | DIV(33)  |
| BLOCK TRANSFER            | XFER(70) |
| BLOCK SET                 | BSET(71) |
| SQUARE ROOT               | ROOT(72) |
| DATA EXCHANGE             | XCHG(73) |
| 7-SEGMENT DECODER         | SDEC(78) |
| FLOATING POINT DIVIDE     | FDIV(79) |
| SINGLE WORD DISTRIBUTE    | DIST(80) |
| DATA COLLECT              | COLL(81) |
| MOVE BIT                  | MOVB(82) |
| MOVE DIGIT                | MOVD(83) |
| REVERSIBLE SHIFT REGISTER | SFTR(84) |
| TABLE COMPARE             | TCMP(85) |
| I/O WRITE                 | WRIT(87) |
| I/O READ                  | READ(88) |
| NETWORK SEND              | SEND(90) |
| SUBROUTINE START          | SBN(92)  |
| WATCHDOG TIMER REFRESH    | WDT(94)  |
| I/O REFRESH               | IORF(97) |
| NETWORK RECEIVE           | RECV(98) |

## Appendix D

### Error and Arithmetic Flag Operation

The following table shows the instructions that affect the Error (ER), Carry (CY), Greater Than (GT), Equals (EQ), and Less Than (LT) Flags. Vertical arrows in the table indicate the flags that are turned ON and OFF according to the result of the instruction. Instructions not shown do not affect any of the flags in the table.

In general, ER indicates that operand data is not within requirements. CY indicates arithmetic or data shift results. GT indicates that a compared value is larger than some standard, LT that it is smaller, and EQ, that it is the same. The status of these flags is maintained until another instruction that affects the flag is executed.

Although ladder diagram instructions, TIM, TIMH(15), CNT, and CNTR(12) are executed when ER is ON, other instructions with a vertical arrow under the ER column are not executed if ER is ON. All of the other flags in the following table will also not operate when ER is ON.

The status of these flags cannot be monitored from the Programming Device, because the flags are turned OFF when the END(01) instruction is executed.

| Instructions | 1303 (ER)  | 1304 (CY)  | 1305 (GR)  | 1306 (EQ)  | 1307 (LE)  |
|--------------|------------|------------|------------|------------|------------|
| TIM          | ↕          | Unaffected | Unaffected | Unaffected | Unaffected |
| CNT          |            |            |            |            |            |
| END(01)      | OFF        | OFF        | OFF        | OFF        | OFF        |
| CNTR(12)     | ↕          | Unaffected | Unaffected | Unaffected | Unaffected |
| TIMH(15)     |            |            |            |            |            |
| CMP(20)      | Unaffected | Unaffected | ↕          | ↕          | ↕          |
| MOV(21)      | Unaffected | Unaffected | Unaffected | ↕          | Unaffected |
| MVN(22)      |            |            |            |            |            |
| BIN(23)      | ↕          | Unaffected | Unaffected | ↕          | Unaffected |
| BCD(24)      |            |            |            |            |            |
| ASL(25)      | Unaffected | ↕          | Unaffected | ↕          | Unaffected |
| ASR(26)      |            |            |            |            |            |
| ROL(27)      |            |            |            |            |            |
| ROR(28)      |            |            |            |            |            |
| COM(29)      | Unaffected | Unaffected | Unaffected | ↕          | Unaffected |
| ADD(30)      | ↕          | ↕          | Unaffected | ↕          | Unaffected |
| SUB(31)      |            |            |            |            |            |
| ANDW(34)     | Unaffected | Unaffected | Unaffected | ↕          | Unaffected |
| ORW(35)      |            |            |            |            |            |
| XORW(36)     |            |            |            |            |            |
| XNRW(37)     |            |            |            |            |            |
| INC(38)      | ↕          | Unaffected | Unaffected | ↕          | Unaffected |
| DEC(39)      |            |            |            |            |            |
| STC(40)      | Unaffected | ON         | Unaffected | Unaffected | Unaffected |
| CLC(41)      | Unaffected | OFF        | Unaffected | Unaffected | Unaffected |
| SLD(74)      | ↕          | Unaffected | Unaffected | Unaffected | Unaffected |
| SRD(75)      |            |            |            |            |            |
| MLPX(76)     |            |            |            |            |            |
| DMPX(77)     |            |            |            |            |            |
|              |            |            |            |            |            |

# Index

## C

clock data, DM area, 18  
configuration, example, 2  
connectors  
  GPC/FIT/LSS, 4  
  installation, 44  
counters. *See* data areas

## D

data areas  
  DM, 18—19  
  IR, 14  
  special relay area  
    arithmetic flags, operation, 55  
    error flag, operation, 55  
  SR area, 18  
  TC, 18  
  TR bits, 18  
  work bits, 17  
data transfer, DIP switch setting, 11  
DIP switch  
  I/O operation settings, 15  
  settings, 6, 11  
DM area. *See* data areas

## E

errors  
  long scan time, 29  
  troubleshooting, 36

## F

features, 2  
  comparison with C500-LDP01, 3  
FIT, 23  
fuse, 37

## G

GPC, 23

## H

high-speed inputs, 34  
high-speed input, DIP switch setting, 11

## I

I/O  
  normal operation, 15  
  operation via WRIT(87)/READ(88), 16  
I/O refresh, 28  
I/O refresh period, 32  
I/O response time, 32  
independent operation, 23  
indicators  
  error messages, 36  
  selecting operation, 7—10  
input OFF delay, I/O response time, 33  
input ON delay, I/O response time, 33  
installation, connectors, 44  
instruction set  
  READ(88), I/O operation, 16  
  relation with C500, 2  
  WRIT(87), I/O operation, 16  
instructions, execution times, 29  
IR area. *See* data areas

## L

linked operation, 22  
  DIP switch setting, 11  
LSS, 23

## M

maintenance, 37  
memory capacity, 22  
modes, changing selectors, 6  
MONITOR mode, 22

## N

nomenclature, 4



## O

online operations. *See* Programming Devices  
operating modes, 22, 28  
  changing, 22  
  independent operation, 23  
  linked operation, 22  
operation, CPU processing, 28  
outputs, external, switching capacity, 44

## P

program addresses, 22  
program capacity, 22  
PROGRAM mode, 22  
Programming Devices, 23  
  online operation, precautions, 26  
  online operations  
    FIT/LSS, 25  
    GPC, 24  
  servicing, 28

## R

reset switch, 6  
RS-485. *See* connectors

RUN mode, 22

## S

scan, 28  
scan time, 28  
  errors, 29  
  I/O response time, 33  
  instruction execution times, 29  
selectors, setting, 6  
specification, external I/O, 42  
specifications, 41  
SR area. *See* data areas

## T

TC area. *See* data areas  
timers. *See* data areas  
TR bits. *See* data areas

## W

work bits. *See* data areas  
WRIT(87)/READ(88)  
  *See also* instruction set  
  effect on scan time, 29

# OMRON Sales Offices

## AMERICA

### BRASIL

OMRON ELETRÔNICA DO BRASIL LTDA.  
Rua Acruas, 220-Jd. Aeroporto  
CEP 04612-São Paulo/SP  
Tel: (11)542-1611/Fax: (11)241-0736  
Tlx: 1154121 OMRO BR

### CANADA

OMRON CANADA INC.  
350 Middlefield Road,  
Scarborough, Ontario M1S 5B1  
Tel: (416)298-9988/Fax: (416)293-1816/Tlx: 065-25360

### Montreal

OMRON CANADA INC. (Regional Office)  
227 Place Frontenac, Pointe Claire, Quebec H9R 4Z7  
Tel: (514)694-6361

### U.S.A.

OMRON ELECTRONICS INC.  
1 East Commerce Drive, Schaumburg, IL 60173  
Tel: (708)843-7900/Fax: (708)843-8568  
Tlx: 910-291-0426 OMRONELEC SHBU

### Atlanta

1815 Century Blvd., Suite 120  
Atlanta, GA 30345  
Tel: (404)315-1636/Fax: (404)477-2115

### Boston

175 Andover Street,  
Danvers, MA01923  
Tel: (508)774-6501/Fax: (508)774-310

### Cincinnati

4350 Glendale-Milford Road,  
Suite 110 Cincinnati, OH 45242  
Tel: (513)733-8334/Fax: (513)733-8363

### Dallas

1501 LBJ Freeway, Suite 160, MS109  
Dallas, TX 75234  
Tel: (214)241-2597/Fax: (214)522-2840

### Los Angeles

750 The City Drive S, #120  
Orange, CA 92668-4940  
Tel: (714)937-6333/Fax: (714)937-6366

### Philadelphia

180 Sheree Blvd.,  
Suite 3800, Exton, PA 19341  
Tel: (215)524-1897/Fax: (215)524-5631

### San Francisco

20045 Stevens Creek Blvd. Suite 1B,  
Cupertino CA95014  
Tel: (408)255-9231/Fax: (408)996-3854  
Tlx: (910)338-0503

## OCEANIA & ASIA

### AUSTRALIA

OMRON ELECTRONICS PTY. LTD.  
Unit 3A, 13 Rodborough Rd., Frenchs Forest  
Tel: (02)975-1511/Fax: (02)975-1518

### HONG KONG

OMRON ELECTRONICS ASIA LTD.  
Unit 1510-12, Silvercord Tower 1  
30, Canton Road, Tsimshatsui, Kowloon  
Tel: 3753827/Fax: 3751475/Tlx: 41092 OMRON HX

### INDONESIA

P.T. INTERPANCA WIRA DINAMIKA  
Jl. Pinangia Timur No. 48  
Jakarta 11110 Indonesia  
Tel: 6900601 (4 lines)/Fax: 6499081/Tlx: 42951-IA

### JAPAN

OMRON Corporation  
FA Division H.Q.  
13F Gotenyama Mori Bldg.  
4-7-35, Kitashinagawa, Shinagawa-ku,  
Tokyo 140 Japan  
Tel: (03)5488-3189/Fax: (03)5488-3271

### CHINA

OMRON CONTROL SYSTEM (CHINA) CO., LTD.  
5/F Chang Fu Gong Office Bldg.,  
A-26 Jian Guo Men Wai Da Jie, Beijing  
Tel: 513-0674.75/Fax: 513-9236

### KOREA

OMRON KOREA CO., LTD.  
Room No. 802, New Seoul Bldg., #618-3 Sin Sa-Dong,  
Kang Nam-Gu Seoul  
Tel: (822)512-0871/Fax: (822)511-9279

### MALAYSIA

OMRON ELECTRONICS SALES AND SERVICE (M)  
SDN BHD  
103 Jalan SS25/2, Jaya Mewah,  
47301 Pataling Jaya Selangor  
Tel: (03)7037323/Fax: (03)7036618

### NEW ZEALAND

OMRON ELECTRONICS LTD.  
65 Boston Road, Private Bag,  
Symonds Street, Auckland  
Tel: 09-358-4400/Fax: 09-358-4411

### PAKISTAN

KARIKO  
7, Scotch Corner, Upper Mall Lahore-3  
Tel: 42-875805/Fax: 42-322787/Tlx: 44679 CTOLH PK

### PHILIPPINES

P.I. ELECTRICAL SUPPLY CO., INC.  
682-684 Rizal Avenue, Manila  
Tel: 49-86-20/Tlx: 63299 PIELSU PN

### SINGAPORE

OMRON SINGAPORE (PTE.)LTD.  
5 Little Road #08-01, Cemtex Industrial Bldg, 1953  
Tel: 2830006/Fax: 2850682/Tlx: RS23403

## **OMRON Sales Offices (Continued)**

### **TAIWAN**

OMRON TAIWAN ELECTRONICS INC.  
MAIN OFFICE  
6F. Home Young Bldg, No. 363, Fu-Shing N. Rd.  
Taipei, Taiwan, R.O.C.  
Tel: 2-716-3745/Fax: 2-712-6712

### **THAILAND**

OMRON-TRISAK CO., LTD.  
248 Rajchadapisek Rd. Huay Kwang  
Bangkok 10310 Thailand  
Tel: 276-1022/Fax: 276-1966

---

## **EUROPE**

---

### **AUSTRIA**

OMRON ELECTRONICS GES.M.B.H.  
Altmannsdorferstrasse 142, A-1232 Vienna  
Tel: 001-43-222-80190/Fax: 001-43-222-8044846  
Tlx: 134832

### **BELGIUM**

OMRON ELECTRONICS N.V./S.A.  
Stationsstraat 24, B-1702 Groot-Bijgaarden  
Tel: (02)4662480/Fax: (02)4660687/Tlx: 62150

### **DENMARK**

OMRON ELECTRONICS A/S  
Odinsvej 15  
DK-2600 Glostrup  
Tel: 45-43440011/Fax: 45-43440211

### **FINLAND**

OMRON ELECTRONICS OY  
Metsanpo jankuja 5  
SF-02130 ESPOO  
Tel: 001-358-0-460511/Fax: 001-358-0-460136

### **FRANCE**

OMRON ELECTRONICS S.a.r.l.  
BP33, 19, rue du Bois Galon,  
94121 Fontenay-Sous-Bois, Cédex, Paris  
Tel: (1)48761212/Fax: (1)48760930/Tlx: 264931

### **GREECE**

KALAMARAKIS & SAPOUNAS, S.A.  
10, Great Kydonion Street, GR-111 44 Athens  
Tel: (01)2235511.12/Fax: (01)2027500  
Tlx: 216736

### **ITALY**

OMRON ELECTRONICS S.r.l.  
Viale Certosa 49, 20149 Milano  
Tel: (02)32681/Fax: (02)325154

### **NETHERLANDS**

OMRON ELECTRONICS B.V.  
Jan Rebelstraat 4, NL-1069 CB, Amsterdam-Osdorp  
Tel: (020)6196363/Fax: (020)6198292

### **NORWAY**

OMRON ELECTRONICS NORWAY A/S  
P.O. Box 109 Bryn, N-0611  
OSLO 6 Norway  
Tel: +47(2)65 75 00/Fax: +47(2)65 83 00

### **PORTUGAL**

OMRON ELECTRONICS LDA.  
Edificio OMRON  
Rua de Sao Tome, Lote 131  
2685 SACAEM  
Tel: 35-1-1-941-7599/Fax: 35-1-1-941-7899

### **SPAIN**

OMRON ELECTRONICS S.A.  
c/Arturo Soria 95, E-28027 Madrid  
Tel: (91)4070211/Fax: 001-34-1-3772269  
Tlx: 49190 OMRES E

### **SWEDEN**

OMRON ELECTRONICS A.B.  
Vallgatan 9 S-17166 Solna Sweden  
Tel: (46)8-6551800/Fax: (46)8-6551960

### **SWITZERLAND**

OMRON ELECTRONICS AG  
Gewerbstrasse 7, 6330 Cham  
Tel: (042)416441/Fax: (042)416445/Tlx: 862118

### **U.K.**

OMRON ELECTRONICS LTD.  
1 Apsley Way, Staples Corner, London NW2 7HF  
Tel: (81)4504646/Fax: (81)4503186

### **GERMANY**

OMRON ELECTRONICS G.m.b.H.  
Oberrather Strasse, 6, D-4000 Düsseldorf 30  
Tel: (0211)96580/Fax: (0211)9658107/Tlx: 8581890

---

## **MIDDLE EAST & AFRICA**

---

### **BAHRAIN**

EBRAHIM AL-SHAKAR & SONS  
P.O Box 5344, Manama 304  
Tel: 254418/Tlx: 8588 ESSCO-BN

### **KENYA**

SWITCHGEAR & CONTROLS, LTD.  
P.O. Box 42503, Nairobi  
Tel: 540381/Tlx: 25522 SWITCH GR

### **KUWAIT**

AMMAR & PARTNERS ELECTRICAL CO  
P.O. Box 1871, 13019 Safat  
Tel: 4830122/Fax: 4841818/Tlx: 44486 APPECO

### **MOROCCO**

MEST COMPOSANTS ELECTRONIQUES  
4, Rue De Provins Casablanca  
Tel: 246390/Tlx: 26902 MEST M

### **SAUDI ARABIA**

TAYSEER AL SHEIKH CORPORATION  
Prince Majed Street P.O. Box 19865, Jeddah 21445  
Tel: 2-6717285/Fax: 2-6721910  
Tlx: 606292 TAYSCO SJ

### **TUNISIA**

AXAFRICE  
10, Avenue H. Bourguiba, 1001 Tunis  
Tel: 1-255304/Fax: 1-750463

**TURKEY**

OMRON ELECTRONICS LTD.  
Acibadem Caddesi Palmiye Sokak 12,  
81020 Kadikoy, Istanbul  
Tel: (90)1-326-2980/Fax: (90)1-326-2979

**U.A.E.**

DEIRA GENERAL MARKETING  
P.O. Box 11370, Dubai  
Tel: (4)624111/Fax: 625629/Tlx: 48557 DEGAM EM

## Revision History

A manual revision code appears as a suffix to the catalog number on the front cover of the manual.

Cat. No. W151-E1-3

↑  
Revision code

The following table outlines the changes made to the manual during each revision. Page numbers refer to the previous version.

| Revision code | Date          | Revised content   |
|---------------|---------------|---|
| 1             | February 1989 | Original production (C500-LDP01)  |
| 2             | June 1989     | Corrections to pages 18, 22 to 26   |
| 3             | January 1992  | Revision for new model (C500-LDP01-V1). For a list of the differences between the C500-LDP01 and the C500-LDP01-V1 refer to <i>Section 1-3 Comparing the C500-LDP01 and the C500-LDP01-V1</i> . |