

Efficient, Compact CV Class 2 LED Drivers with 0-10 V Dimming

Nominal Input Voltage	Max. Output Power	Nominal Output Voltage	Max. Output Current	Efficiency	Max. Case Temperature	THD	Power Factor	Dimming Method	Dimming Range	Startup Time
120 & 277 Vac	90 W	24, 48 Vdc	3.75, 1.9 A	up to 90% typical	90°C (measured at the hot spot)	< 20%	> 0.9	0 - 10 V	1 - 100%	300 ms typical

Models with Flying Leads, Aluminum Case (VZM100):
L 150.2 x W 38.8 x H 24.9 mm
(L 5.91 x W 1.53 x H 0.98 in)
VZM060 dimensions on page 13

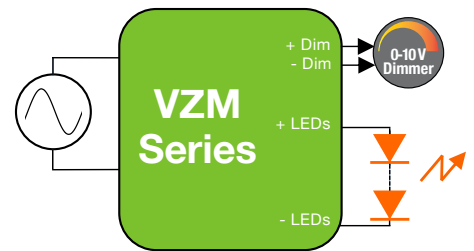

FEATURES

- Class 2 power supply
- UL Class P
- Ripple $\leq 5\%$ @ 20% & 100% load
- Constant voltage mode with over-current protection
- IP20-rated case with silicone-based potting
- 90°C maximum case hot spot temperature
- Lifetime: 5 years min at 85°C case temperature
- EMI: Compliant with FCC CFR Title 47 Part 15 Class B at 120 Vac & Class A at 277 Vac
- Surge protection:
 - IEC61000-4-5: 2 kV line to line/2 kV line to earth
 - 2.5 kV ring wave: ANSI/IEEE c62.41.1-2002 & c62.41.2-2002 category A
- Complies with ENERGY STAR®, DLC (DesignLight Consortium®) and CA Title 24 technical requirements

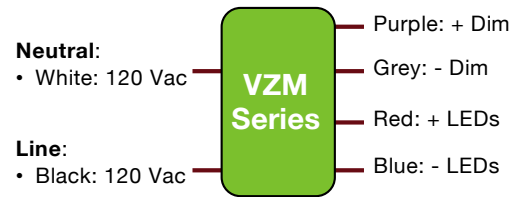

Wiring Diagram

NFC PROGRAMMING

- Programmable output voltage for optimal dimming range
- Fully programmable 0-10 V dimming profile with dim-to-off

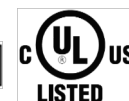

Efficient, Compact CV Class 2 LED Drivers with 0-10 V Dimming

1 - ORDERING INFORMATION

ERP Part Number	Nominal Input Voltage (Vac)	Pout Max (W)	Vout Max (Vdc)	Iout Min (A)	Iout Max (A)	Open Loop Voltage (No Load Vout Max) (Vdc)	Comments
60 W							
VZM060W-24	120 & 277	60	24	0.25	2.50	25.68	Side leads
VZM060W-48	120 & 277	60	48	0.13	1.25	51.36	Side leads
90 W							
VZM100W-24	120 & 277	90	24	0.38	3.75	25.68	Side leads
VZM100W-48	120 & 277	90	48	0.19	1.87	51.36	Side leads

Programming Wand

Part number: NFC_WAND



Notes:

- For additional options of output voltage, contact your sales representative or send an email to: SaveEnergy@erp-power.com
- Please order the programming wand using the part number NFC_WAND.

Efficient, Compact CV Class 2 LED Drivers with 0-10 V Dimming

2 - INPUT SPECIFICATION (@25°C ambient temperature)

	Units	Minimum	Typical	Maximum	Notes
Input Voltage Range (Vin)	Vac	90	120, 277	305	•At maximum load, as specified in section 1
Input Frequency Range	Hz	47	60	63	
Input Current (Iin)	A			1.05 A @ 120 Vac 0.48 A @ 277 Vac	
Power Factor (PF)		0.9	> 0.9		•At nominal input voltage •From 100% to 60% of maximum rated power
Inrush Current	A	Meets NEMA-410 requirements			•At any point on the sine wave and 25°C
Leakage Current	µA			400 µA @ 120 Vac 920 µA @ 277 Vac	Measured per IEC60950-1
Input Harmonics	Complies with IEC61000-3-2 for Class C equipment				
Total Harmonics Distortion (THD)				20%	•At nominal input voltage •From 100% to 60% of maximum rated power •Complies with DLC (Design Light Consortium) technical requirements
Efficiency	%	-	up to 90%	-	Measured with nominal input voltage
Isolation	The AC input to the main DC output is isolated and meets Class II reinforced/double insulation power supply <input type="checkbox"/>				

3 - OUTPUT SPECIFICATION (@25°C ambient temperature)

	Units	Minimum	Typical	Maximum	Notes
Output Voltage (Vout)	Vdc	16.4 32.0	24 48		See ordering information for details
Output Current (Iout)	A			24 Vdc: 3.75 A 48 Vdc: 1.9 A	
Output Voltage Regulation	%	-5		5	•At nominal AC line voltage •Includes load and voltage set point variations.
Output Voltage Overshoot	%	-	-	10	The driver does not operate outside of the regulation requirements for more than 500 ms during power on with maximum load.
Ripple Voltage	≤ 5% of rated output voltage for each model				•Measured at maximum load and nominal input voltage. •At 20% & 100% load
Dimming Range	%	1		100	•Dimming is a function of the output voltage and is achieved through decreasing Vout. •When testing, if light is measured, dimming range is based on light output. If no light is measured, dimming range is based on percentage of output current. •The dimming range is dependent on each specific dimmer and LED load. It may not be able to achieve 1% dimming with some dimmers or LED loads. •Refer to section 6 for additional information regarding the 0-10V dimming characteristics of the VZM series.
Start-up Time	ms		300	500	•Measured from application of AC line voltage to 100% light output •Complies with ENERGY STAR® luminaire specification and CA Title 24
Isolation	The main DC output is certified and tested per UL8750 Class 2 or LED Class 2. In models without the "-FN" suffix, the 0-10 V dimming circuit is isolated from the AC input and the DC output.				

Efficient, Compact CV Class 2 LED Drivers with 0-10 V Dimming

4 - ENVIRONMENTAL CONDITIONS

	Units	Minimum	Typical	Maximum	Notes
Operating Ambient Temperature (Ta)	°C	-10		40	When mounted to insulating material such as wood or drywall with junction box such that at Ta ≤ 40°C Tc does not exceed 85°C
Maximum Case Temperature (Tc)	°C			+90	Case temperature measured at the hot spot •tc
Storage Temperature	°C	-40		+85	
Humidity	%	5	-	95	Non-condensing
Cooling	Convection cooled				
Acoustic Noise	dBA			22	Measured at a distance of 1 foot (30 cm)
Mechanical Shock Protection	per EN60068-2-27				
Vibration Protection	per EN60068-2-6 & EN60068-2-64				
MTBF	> 200,000 hours when operated at nominal input and output conditions, and at Tc ≤ 85°C				
Lifetime	5 years at Ta ≤ 40°C. Tc ≤ 85°C maximum case hot spot temperature				
Warranty	5 years. Users must utilize proper thermal management techniques to ensure proper thermal conductivity between the driver and heat sink. The use of double-sided tape to mount the driver voids the warranty.				

5 - EMC COMPLIANCE AND SAFETY APPROVALS

EMC Compliance			
Conducted and Radiated EMI	Compliant with FCC CFR Title 47 Part 15 Class B at 120 Vac & Class A at 277 Vac		
Harmonic Current Emissions	IEC61000-3-2	For Class C equipment	
Voltage Fluctuations & Flicker	IEC61000-3-3		
Immunity Compliance	ESD (Electrostatic Discharge)	IEC61000-4-2	6 kV contact discharge, 8 kV air discharge, level 3
	RF Electromagnetic Field Susceptibility	IEC61000-4-3	3 V/m, 80 - 1000 MHz, 80% modulated at a distance of 3 meters
	Electrical Fast Transient	IEC61000-4-4	± 2 kV on AC power port for 1 minute, ±1 kV on signal/control lines
	Surge	IEC61000-4-5	± 2 kV line to line (differential mode) / ± 2 kV line to common mode ground (tested to secondary ground) on AC power port, ±0.5 kV for outdoor cables
		ANSI/IEEE c62.41.1-2002 & c62.41.2-2002 category A, 2.5 kV ring wave	
	Conducted RF Disturbances	IEC61000-4-6	3V, 0.15-80 MHz, 80% modulated
Voltage Dips	IEC61000-4-11	>95% dip, 0.5 period; 30% dip, 25 periods; 95% reduction, 250 periods	
Safety Agency Approvals			
UL	UL8750 listed, Class 2, Class P		
cUL	CAN/CSA C22.2 No. 250.13-14 LED equipment for lighting applications		

Safety					
	Units	Minimum	Typical	Maximum	Notes
Hi Pot (High Potential) or Dielectric voltage-withstand	Vdc	4400			<ul style="list-style-type: none"> •Insulation between the input (AC line and Neutral) and the output •Tested at the RMS voltage equivalent of 3110 Vac

Efficient, Compact CV Class 2 LED Drivers with 0-10 V Dimming

6 - 0-10 V DIMMING CONTROL (@25°C ambient temperature)

The VZM series exhibits a non-linear dimming profile with 1% minimum dimming and dim-to-off. Dimming is achieved by decreasing the output voltage of the driver. In the default non-linear 0-10 V dimming profile, 10 V to 8.2 V=100% of V_{max} , 1.5 V to 0.7 V=65% of V_{max} , and <0.7 V=dim-to-off. Each point in the non-linear dimming profile (points A-D in figure 1) can be programmed using the programming software.

	Units	Minimum	Typical	Maximum	Notes
+Dim Signal, -Dim Signal		The VZM series operate only with 0-10V dimmers that sink current. The method to dim the output current of the driver is done via the +Dim/-Dim Signal pins. The +Dim/-Dim signal pins can be used to adjust the output setting via a standard commercial wall dimmer, an external control voltage source (0 to 10 Vdc), or a variable resistor when using the recommended number of LEDs. The dimming input permits 1% to 100% dimming with dim-to-off.			
Dimming Profile (see figure 1)		Programmed upper output voltage limit between 10 V and 8.2 V, Linear between 8.2 V and 1.5 V, Programmed lower output voltage limit between 1.5 V and 0.7 V, Output voltage off below 0.7 V.			
Dimming Range	%	1		100	
High Level Voltage - A	V	8.1	8.2	8.3	
Low Level Voltage - B	V		1.5		
Dim to Off - C	V	0.6	0.7	0.8	
Dim to Off Hysteresis - D	V			+0.2	
Current Supplied by the +Dim Signal Pin	mA			1	
Output Voltage Tolerance While Being Dimmed	%			±8	The tolerance of the output voltage while being dimmed is ≤ +/-8% until down to 1.5 V.
Isolation	The 0-10 V circuit is isolated from the AC input meets UL8750 supplement SF requirements. In models without the "-FN" suffix, the 0-10 V circuit is isolated from the AC input and the main DC output.				

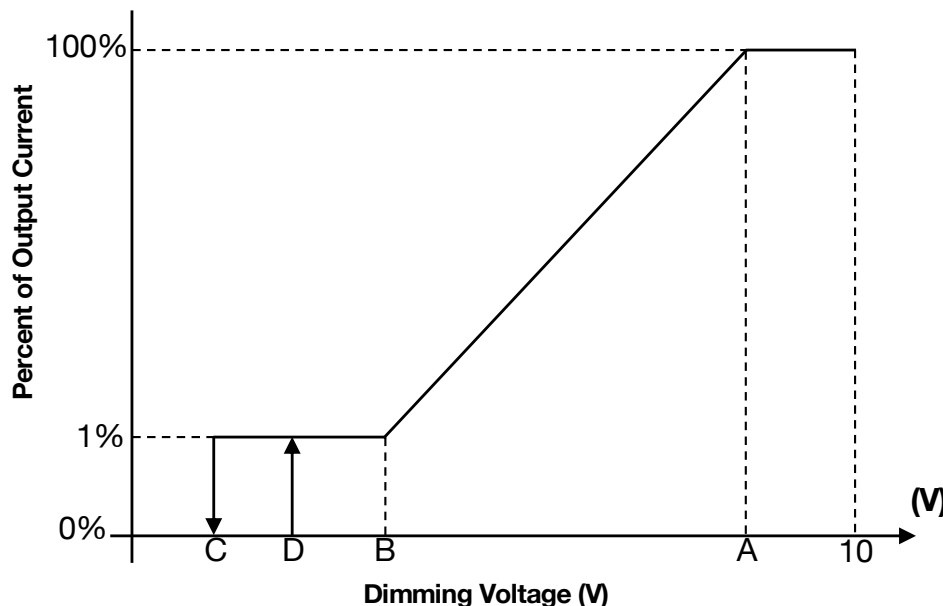

Figure 1

Efficient, Compact CV Class 2 LED Drivers with 0-10 V Dimming

6 - 0-10 V DIMMING CONTROL (@25°C ambient temperature) (CONTINUED)

The VZM series operate only with 0-10 V dimmers that sink current. They are not designed to operate with 0-10 V control systems that source current, as used in theatrical/entertainment systems. Developed in the 1980's, the 0-10 V sinking current control method is adopted by the International Electrotechnical Commission (IEC) as part of its IEC Standard 60929 Annex E.

The method to dim the output voltage of the driver is done via the +Dim/-Dim Signal pins. The +Dim/-Dim Signal pins respond to a 0 to 10 V signal, delivering 65% to 100% of the max output voltage based on rated voltage for each model. A pull-up resistor is included internal to the driver. When the +Dim wire (purple) is short circuited to the -Dim wire (grey) or to the -LED wire (blue), the output voltage turns off.

If the +Dim input is > 10 V or open circuited, the output voltage is programmed to 100% of the rated voltage. When not used, the -Dim wire (grey) and to the +Dim wire (purple) can be individually capped or cut off. In this configuration, no dimming is possible and the driver delivers 100% of its rated output voltage.

The maximum source current (flowing from the driver to the 0-10V dimmer) supplied by the +Dim Signal pin is ≤ 1 mA. The tolerance of the output voltage while being dimmed is +/-8% typical until down to 1.5 V.

The non-linear curve is recommended when using standard in wall 0-10 V logarithmic dimmers to avoid having insufficient source current available to pull the dimmer up to 10 V and to account for the inability of the dimmer to pull below approximately 0.9 V. In these type of installations, the modified transfer function will provide 100% voltage output and dimming to 1%, regardless of the number of drivers on the 0-10V dimming line.

Optimal dimming performance is achieved through balancing the output voltage to the LED load, which can be done using the ERP Driver Configuration Tool. Instead of using the default maximum and minimum output voltages, the user can specify a different maximum and minimum output voltage inside that range. Use the following steps to achieve optimal dimming performance:

1. Determine operating voltage. This will most likely be 24 or 48 V. A lower voltage can be used if desired for thermal performance, extended LED lifetime, etc.
2. Measure the minimum voltage at which the LED produces light to 0.1 V precision.
3. Use the programming software to set the operating and minimum voltage of the VZM in the "Operating Voltage" and "Minimum Dimmed Voltage" fields, respectively.
4. Choose desired dimming profile from drop down menu, or define a custom dimming profile.
5. Click "Program" button, and click "Add Connected Driver Program to Database" button for use in lot programming.

7 - COMPATIBLE 0-10 V DIMMERS

Mfg.	Model	Mfg.	Model	Mfg.	Model
Lutron	NFTV	Lutron	DVTV	Lutron	DVSTV
Lutron	RMJS-8T	Lightolier	SR1200ZTUNV	Cooper	SF10P-W
Leviton	IP710-LFZ	Leviton	IP710-DL		

Programming Wand

Part number: NFC_WAND



Efficient, Compact CV Class 2 LED Drivers with 0-10 V Dimming

■ 8 - PROTECTION FEATURES

Input Over Current Protection

The VZM series incorporates a primary AC line fuse for input over current protection to prevent damage to the LED driver and meet product safety requirements as outlined in Section 6.

Short Circuit and Over Current Protection

The VZM series is protected against short-circuit such that a short from any output to return shall not result in a fire hazard or shock hazard. The driver shall hiccup as a result of a short circuit or over current fault. Removal of the fault will return the driver to within normal operation. The driver shall recover, with no damage, from a short across the output for an indefinite period of time.

Internal Over temperature Protection

The VZM series is equipped with internal temperature sensor on the primary power train. Failure to stay within the convection power rating will result in the power supply reducing the available current (fold back) below the programmed amount. The main output current will be restored to the programmed value when the temperature of the built-in temperature sensor cools adequately.

Output Open Load Protection

When the LED load is removed, the output voltage of the VZM series is typically limited to 1.3 times the maximum output voltage of each model.

Efficient, Compact CV Class 2 LED Drivers with 0-10 V Dimming

9 - PREDICTED LIFETIME VERSUS CASE AND AMBIENT TEMPERATURE

Lifetime is defined by the measurement of the temperatures of all the electrolytic capacitors whose failure would affect light output under the nominal LED load and worst case AC line voltage. The graphs in figures 2 and 3 are determined by the electrolytic capacitor with the shortest lifetime, among all electrolytic capacitors. It represents a worst case scenario in which the LED driver is powered 24 hours/day, 7 days/week. The lifetime of an electrolytic capacitor is measured when any of the following changes in performance are observed:

- 1) Capacitance changes more than 20% of initial value
- 2) Dissipation Factor ($\tan \delta$): 150% or less of initial specified value
- 3) Equivalent Series Resistance (ESR): 150% or less of initial specified value
- 4) Leakage current: less of initial specified value

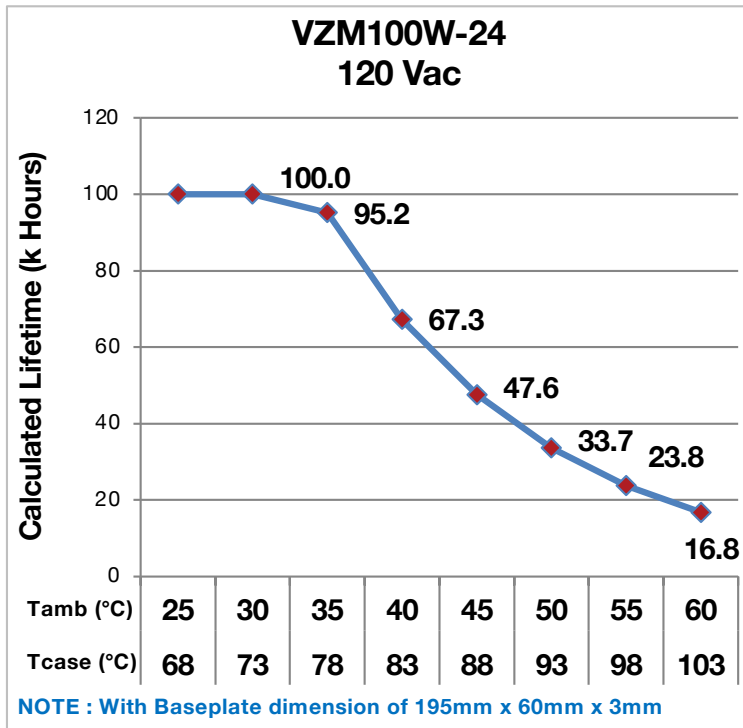

Figure 2

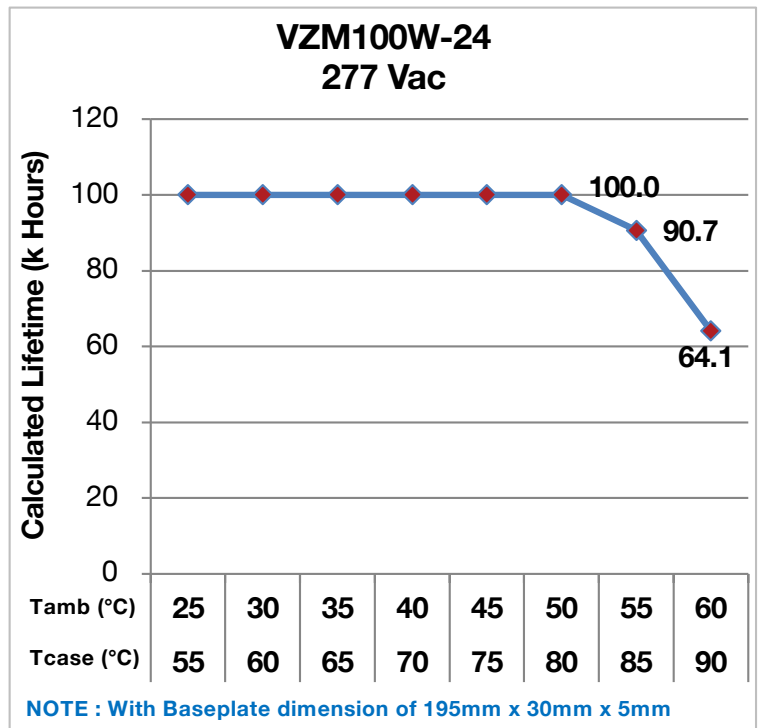

Figure 3

Notes:

- The ambient temperature $T_{ambient}$ and the differential between $T_{ambient}$ and T_{case} mentioned in the above graphs are relevant only as long as both the driver and the light fixture are exposed to the same ambient room temperature. If the LED driver is housed in an enclosure or covered by insulation material, then the ambient room temperature is no longer valid. In this situation, please refer only to the case temperature T_{case} .
- It should be noted the graph "Lifetime vs. Ambient Temperature" may have an error induced in the final application if the mounting has restricted convection flow around the case. For applications where this is evident, the actual case temperature measured at the T_c point in the application should be used for reliability calculations.
- Users must utilize proper thermal management techniques to ensure proper thermal conductivity between the driver and heat sink. The use of double-sided tape to mount the driver voids the warranty.

Efficient, Compact CV Class 2 LED Drivers with 0-10 V Dimming

10 – EFFICIENCY VERSUS LOAD

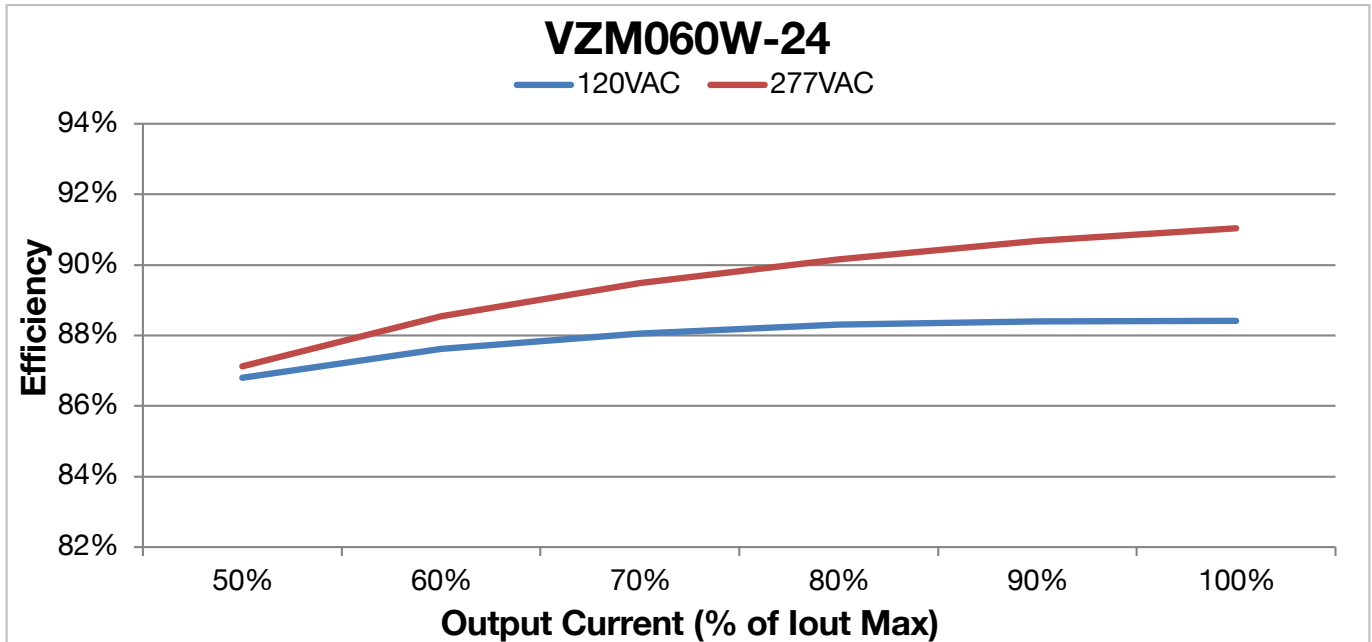

Figure 4

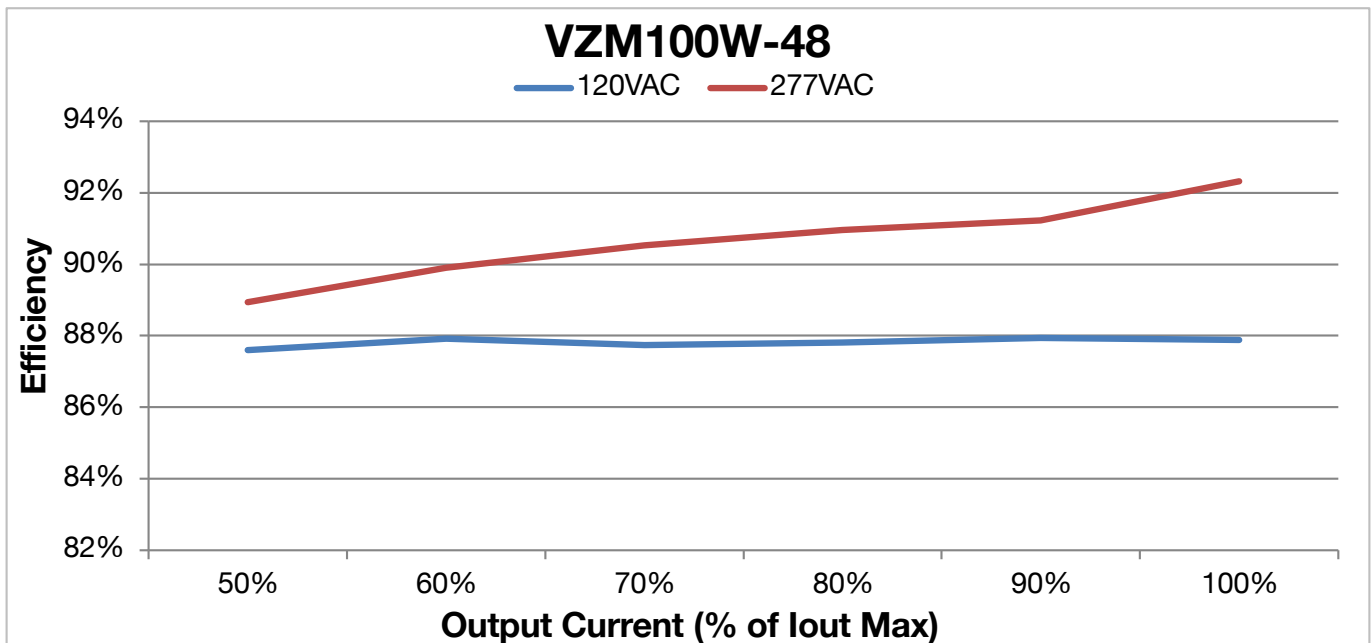

Figure 5

Efficient, Compact CV Class 2 LED Drivers with 0-10 V Dimming

11 – POWER FACTOR VERSUS LOAD

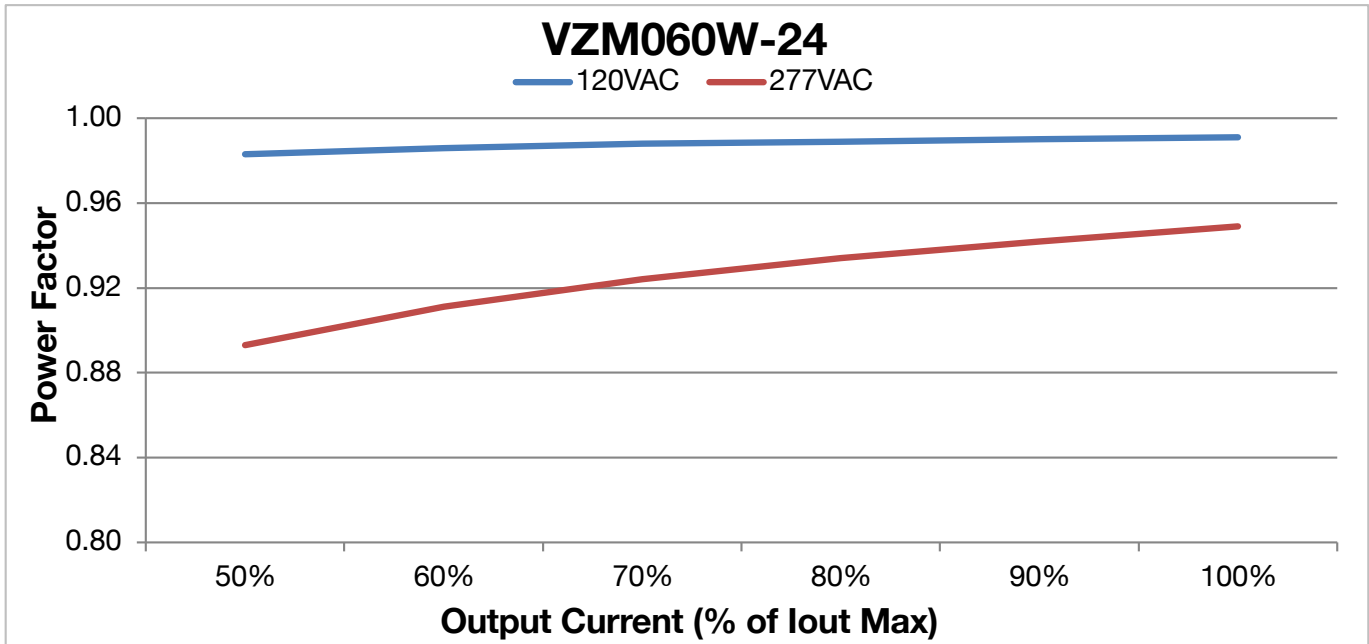

Figure 6

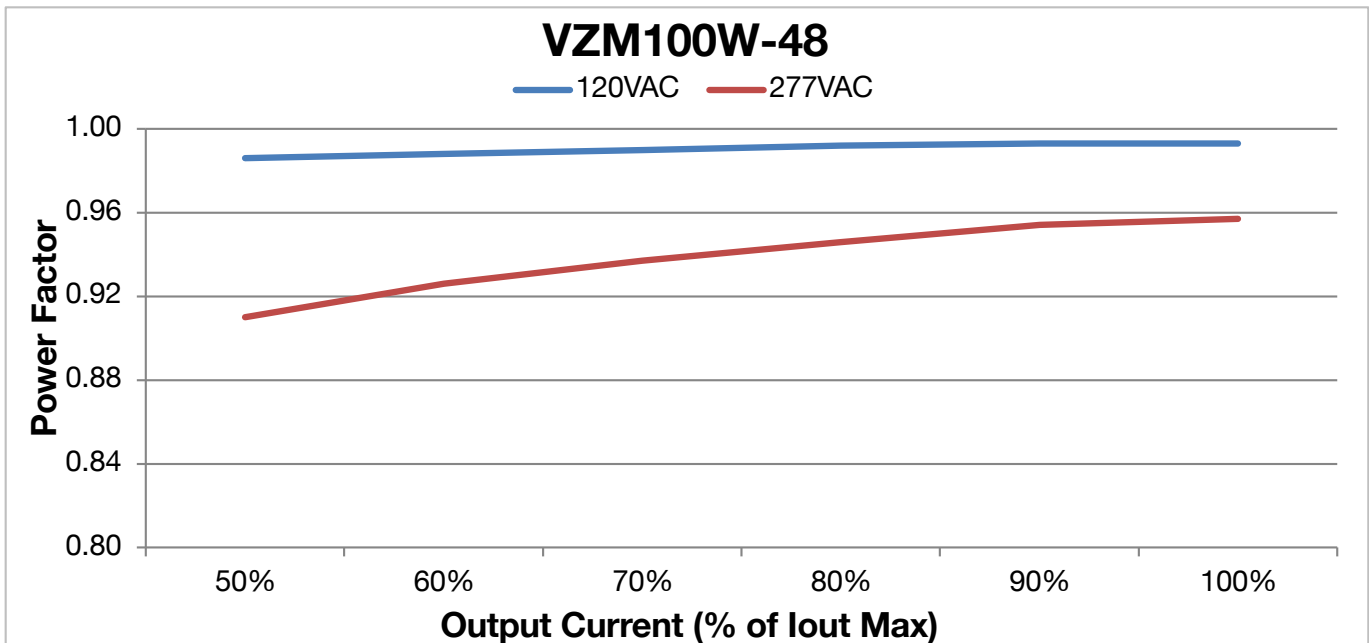

Figure 7

Efficient, Compact CV Class 2 LED Drivers with 0-10 V Dimming

12 – THD VERSUS LOAD

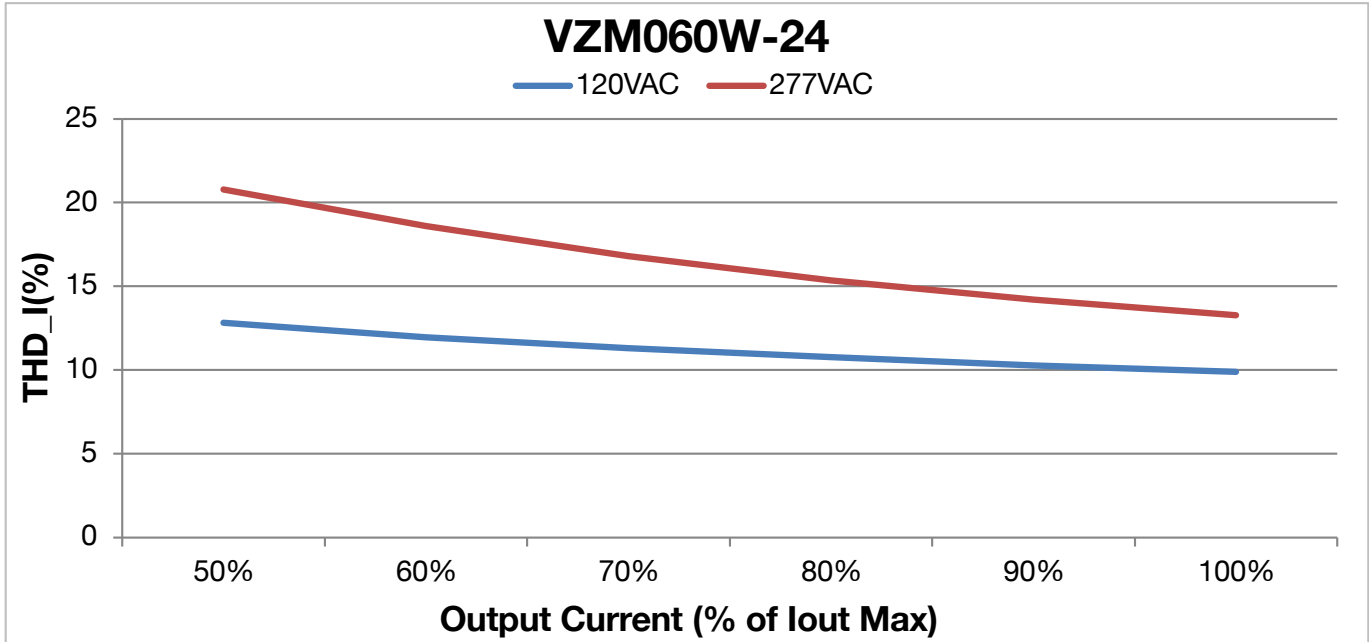

Figure 8

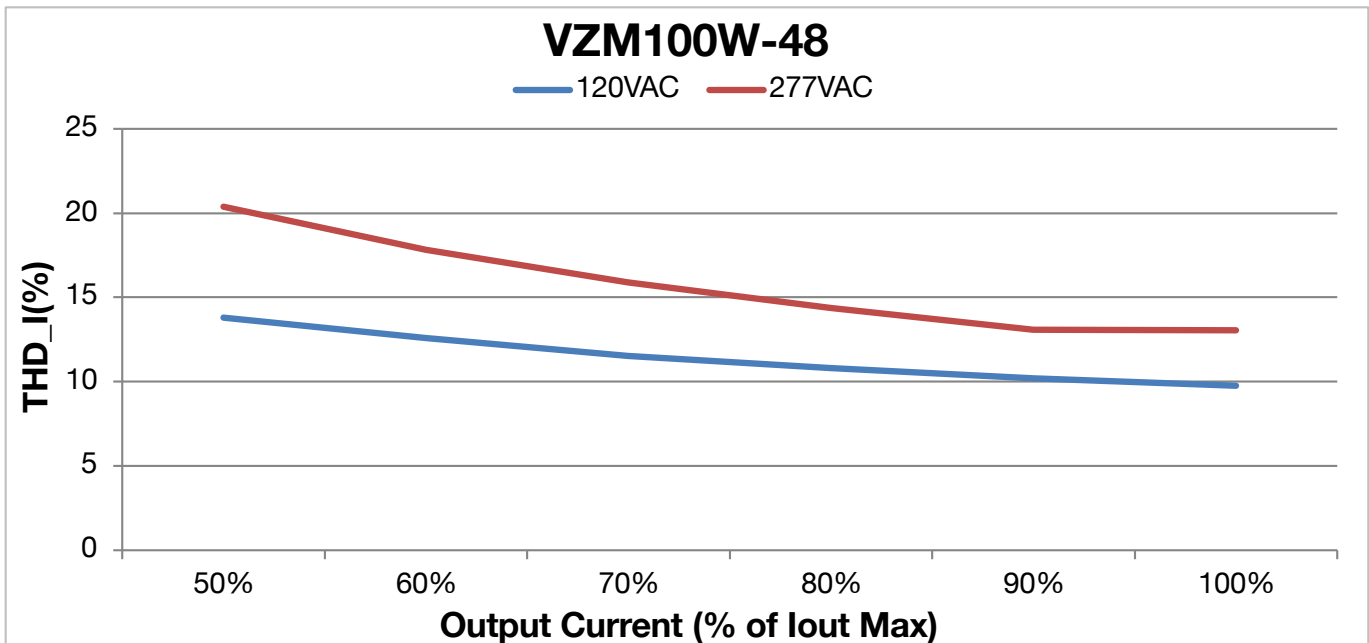

Figure 9

Efficient, Compact CV Class 2 LED Drivers with 0-10 V Dimming

13 - MECHANICAL DETAILS

- **Packaging:** Aluminum case
- **I/O Connections:**
 - **Models with flying leads:** 18 AWG on all leads, 22 AWG on 0-10V dimming wires, 203mm (8 in) long, 105°C rated, stranded, stripped by approximately 9.5 mm, and tinned. All the wires, on both input and output, have a 300 V insulation rating.
- **Ingress Protection:** IP20 rated
- **Mounting Instructions:** The VZM driver case must be secured on a flat surface through the two mounting tabs, shown here below in the case outline drawings. The use of double-sided tape voids the warranty.

14 - OUTLINE DRAWINGS (VLM100)

Dimensions: L 150.2 x W 38.8 x H 24.9 mm (L 5.91 x W 1.53 x H 0.98 in)

Volume: 145.1 cm³ (8.86 in³)

Weight:

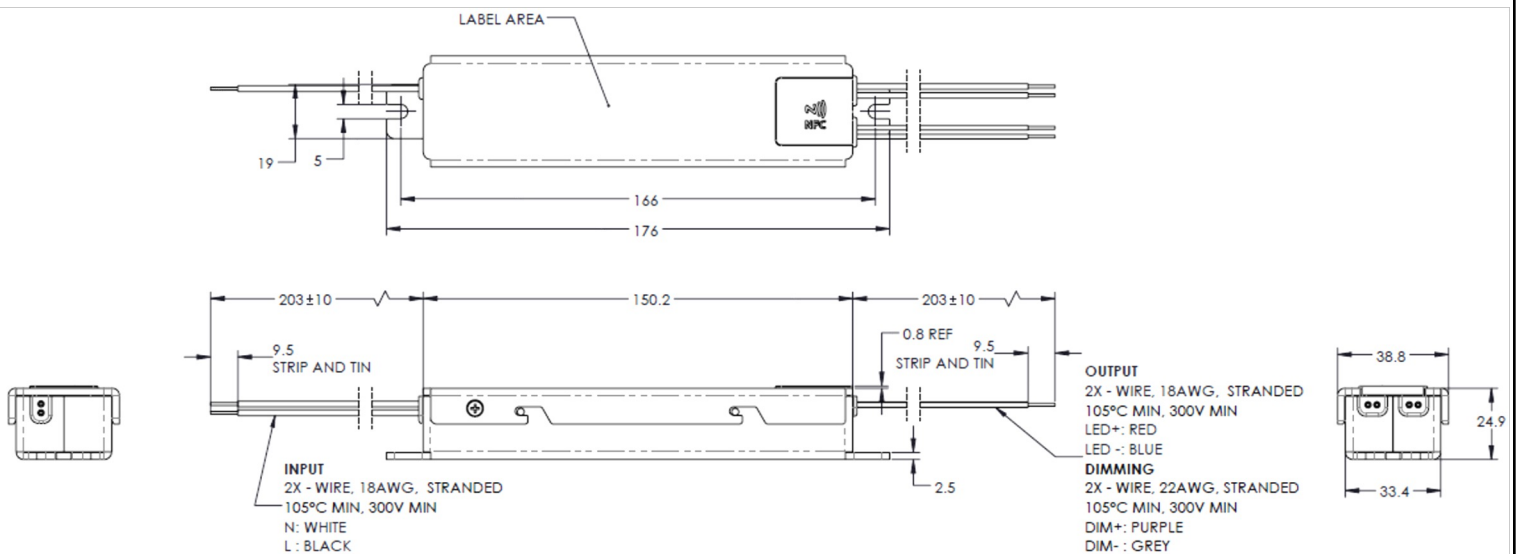

All dimensions are in mm

Figure 10

Efficient, Compact CV Class 2 LED Drivers with 0-10 V Dimming

15 - OUTLINE DRAWINGS (VLM060)

Dimensions: L 148.7 x W 31.8 x H 22.4 mm (L 5.85 x W 1.25 x H 0.88 in)

Volume: 118.1 cm³ (7.18 in³)

Weight:

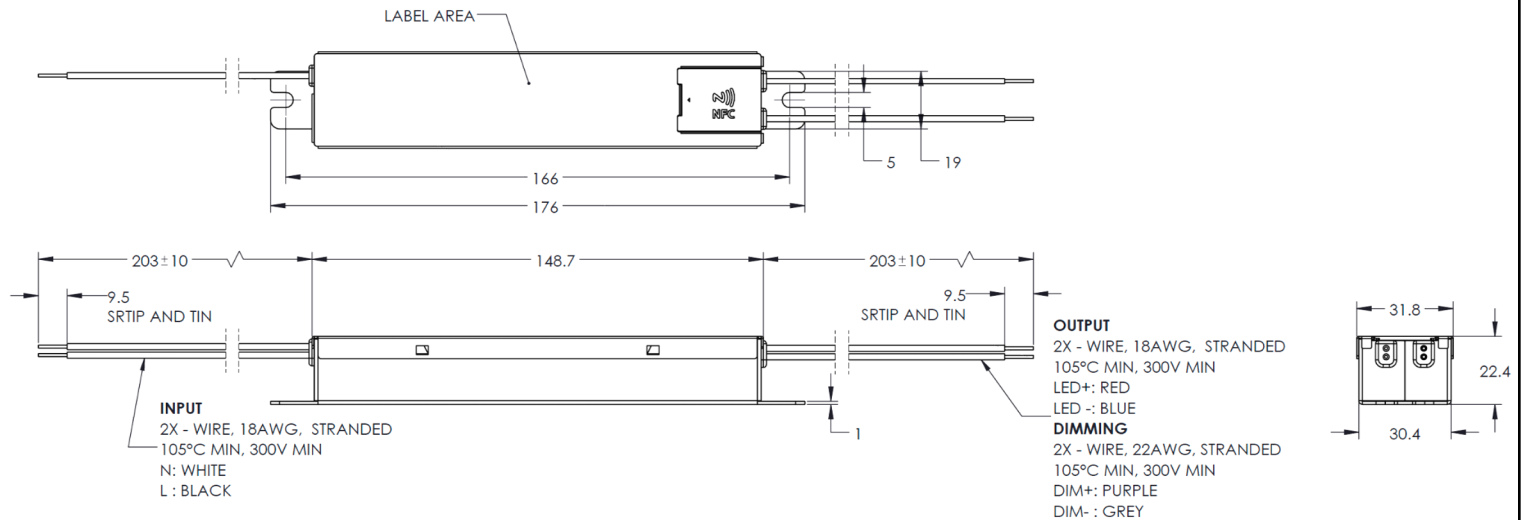

All dimensions are in mm

Figure 11

Efficient, Compact CV Class 2 LED Drivers with 0-10 V Dimming

16 - LABELING

The VZM100W-24 is used in figure 12 as an example to illustrate a typical label.

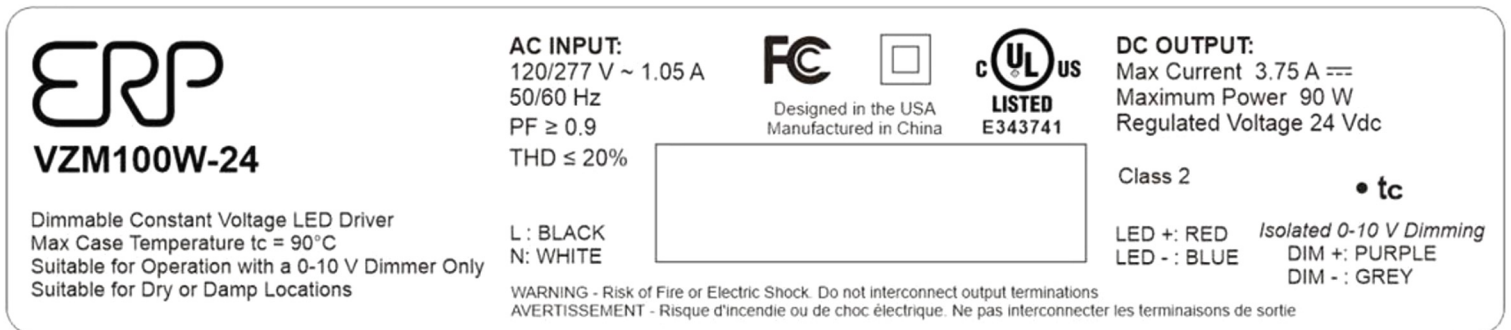

Figure 12

USA Headquarters
 Tel: +1-805-517-1300
 Fax: +1-805-517-1411
 893 Patriot Drive, Suite E,
 Moorpark, CA 93021, USA

CHINA Operations
 Tel: +86-756-6266298
 Fax: +86-756-6266299
 No. 8 Pingdong Road 2
 Zhuhai, Guangdong, China 519060

ERP Power, LLC (ERP) reserves the right to make changes without further notice to any products herein. ERP makes no warranty, representation or guarantee regarding the suitability of its products for any particular purpose, nor does ERP assume any liability arising out of the application or use of any product or circuit, and specifically disclaims any and all liability, including without limitation special, consequential or incidental damages. "Typical" parameters which may be provided in ERP data sheets and/or specifications can and do vary in different applications and actual performance may vary over time. All operating parameters, including "Typicals" must be validated for each customer application by customer's technical experts. ERP does not convey any license under its patent rights nor the rights of others. ERP products are not designed, intended, or authorized for use as components in systems intended for surgical implant into the body, or other applications intended to support or sustain life, or for any other application in which the failure of the ERP product could create a situation where personal injury or death may occur. Should Buyer purchase or use ERP products for any such unintended or unauthorized application, Buyer shall indemnify and hold ERP and its officers, employees, subsidiaries, affiliates, and distributors harmless against all claims, costs, damages, and expenses, and reasonable attorney fees arising out of, directly or indirectly, any claim of personal injury or death associated with such unintended or unauthorized use, even if such claim alleges that ERP was negligent regarding the design or manufacture of the part. ERP is an Equal Opportunity/Affirmative Action Employer. This literature is subject to all applicable copyright laws and is not for resale in any manner.



VZM Series

VZM060

60 W

VZM100

90 W

Efficient, Compact CV Class 2 LED Drivers with 0-10 V Dimming

Revision History

Date	Comments
24JAN2020	<ul style="list-style-type: none">Initial release
19MAR2020	<ul style="list-style-type: none">Pg1: updated input voltagePg2: updated input voltage
21SEP2020	<ul style="list-style-type: none">Various grammar changes
11JAN2022	<ul style="list-style-type: none">Pg2: added “-FN” models
23MAR2023	<ul style="list-style-type: none">Pg1: added RoHS logoPg2: removed “-FN” models