

## High Speed Infrared Emitting Diodes, 850 nm, Surface Emitter Technology



### DESCRIPTION

As part of the [SurfLight™](#) portfolio, the VSMY12850 is an infrared, 850 nm, top looking emitting diode based on GaAlAs surface emitter chip technology with extreme high radiant intensities, high optical power and high speed, molded in clear, untinted PCB based package (with inner lens) for surface mounting (SMD).

### APPLICATIONS

- Emitter for proximity applications
- IR touch panels
- Photointerrupters
- Optical switch

### FEATURES

- Package type: surface mount
- Package form: top view
- Dimensions (L x W x H in mm): 3.2 x 1.6 x 1.1
- Peak wavelength:  $\lambda_p = 850$  nm
- High reliability
- High radiant power
- Very high radiant intensity
- Angle of half intensity:  $\phi = \pm 40^\circ$
- Suitable for high pulse current operation
- Floor life: 168 h, MSL 3, according to J-STD-020
- Material categorization: for definitions of compliance please see [www.vishay.com/doc?99912](http://www.vishay.com/doc?99912)



PRODUCT SUMMARY				
COMPONENT	$I_e$ (mW/sr)	$\phi$ (deg)	$\lambda_p$ (nm)	$t_r$ (ns)
VSMY12850	16	$\pm 40$	850	10

#### Note

- Test conditions see table “Basic Characteristics“

ORDERING INFORMATION			
ORDERING CODE	PACKAGING	REMARKS	PACKAGE FORM
VSMY12850	Tape and reel	MOQ: 3000 pcs, 3000 pcs/reel	Top view

#### Note

- MOQ: minimum order quantity

ABSOLUTE MAXIMUM RATINGS ( $T_{amb} = 25^\circ\text{C}$ , unless otherwise specified)				
PARAMETER	TEST CONDITION	SYMBOL	VALUE	UNIT
Reverse voltage		$V_R$	5	V
Forward current		$I_F$	70	mA
Surge forward current	$t_p = 100 \mu\text{s}$	$I_{FSM}$	1	A
Power dissipation		$P_V$	140	mW
Junction temperature		$T_j$	100	$^\circ\text{C}$
Operating temperature range		$T_{amb}$	-40 to +85	$^\circ\text{C}$
Storage temperature range		$T_{stg}$	-40 to +100	$^\circ\text{C}$
Soldering temperature	acc. figure 10, J-STD-020	$T_{sd}$	260	$^\circ\text{C}$
Thermal resistance junction/ambient	J-STD-051, soldered on PCB	$R_{thJA}$	390	K/W

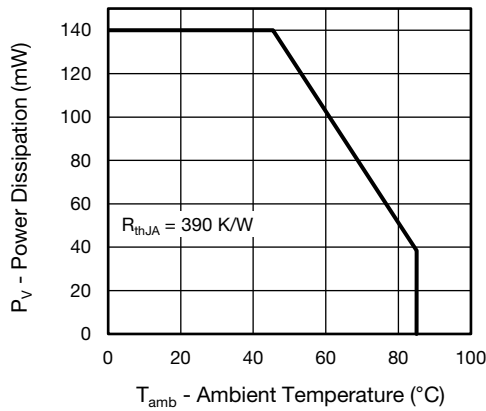


Fig. 1 - Power Dissipation Limit vs. Ambient Temperature

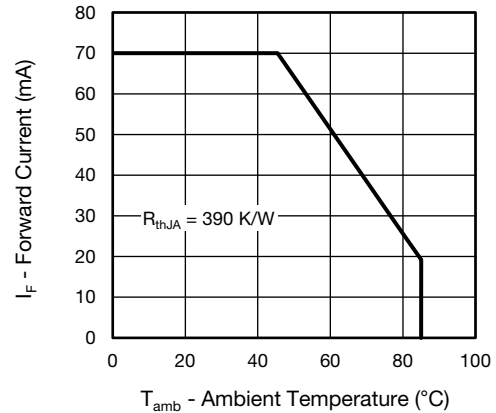


Fig. 2 - Forward Current Limit vs. Ambient Temperature

<b>BASIC CHARACTERISTICS</b> ( $T_{amb} = 25\text{ }^{\circ}\text{C}$ , unless otherwise specified)						
PARAMETER	TEST CONDITION	SYMBOL	MIN.	TYP.	MAX.	UNIT
Forward voltage	$I_F = 20\text{ mA}$ , $t_p = 20\text{ ms}$	$V_F$	1.1	1.4	1.9	V
	$I_F = 70\text{ mA}$ , $t_p = 20\text{ ms}$	$V_F$		1.65		V
	$I_F = 1\text{ A}$ , $t_p = 100\text{ }\mu\text{s}$	$V_F$		2.9		V
Temperature coefficient of $V_F$	$I_F = 20\text{ mA}$	$TK_{V_F}$		-1.7		mV/K
Reverse current		$I_R$	not designed for reverse operation			$\mu\text{A}$
Junction capacitance	$V_R = 0\text{ V}$ , $f = 1\text{ MHz}$ , $E = 0\text{ mW/cm}^2$	$C_J$		5		pF
Radiant intensity	$I_F = 20\text{ mA}$ , $t_p = 20\text{ ms}$	$I_e$	2.3	4.7		mW/sr
	$I_F = 70\text{ mA}$ , $t_p = 20\text{ ms}$	$I_e$		16		mW/sr
	$I_F = 1\text{ A}$ , $t_p = 100\text{ }\mu\text{s}$	$I_e$		130		mW/sr
Radiant power	$I_F = 70\text{ mA}$ , $t_p = 20\text{ ms}$	$\phi_e$		40		mW
Temperature coefficient of radiant power	$I_F = 20\text{ mA}$	$TK_{\phi_e}$		-0.19		%/K
Angle of half intensity		$\phi$		$\pm 40$		deg
Peak wavelength	$I_F = 20\text{ mA}$	$\lambda_p$	830	850	870	nm
Spectral bandwidth	$I_F = 20\text{ mA}$	$\Delta\lambda$		35		nm
Temperature coefficient of $\lambda_p$	$I_F = 20\text{ mA}$	$TK_{\lambda_p}$		0.25		nm/K
Rise time	$I_F = 100\text{ mA}$ , 20 % to 80 %	$t_r$		10		ns
Fall time	$I_F = 100\text{ mA}$ , 20 % to 80 %	$t_f$		10		ns

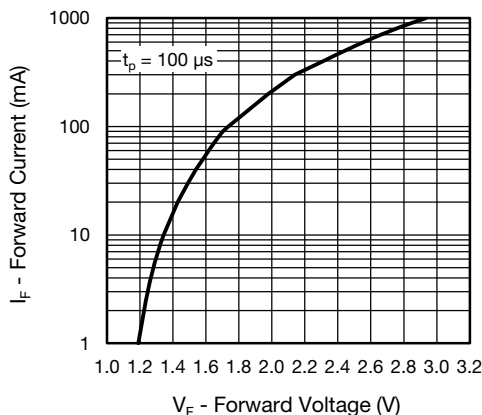
**BASIC CHARACTERISTICS** ( $T_{amb} = 25\text{ }^{\circ}\text{C}$ , unless otherwise specified)


Fig. 3 - Forward Current vs. Forward Voltage

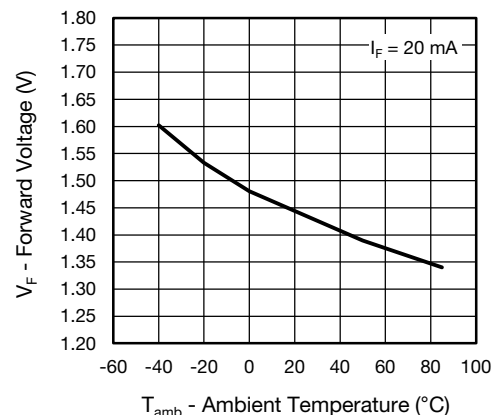


Fig. 4 - Forward Voltage vs. Ambient Temperature



Fig. 5 - Relative Forward Voltage vs. Ambient Temperature

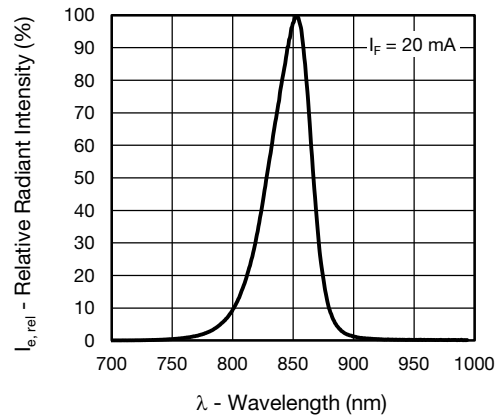


Fig. 8 - Relative Radiant Intensity vs. Wavelength

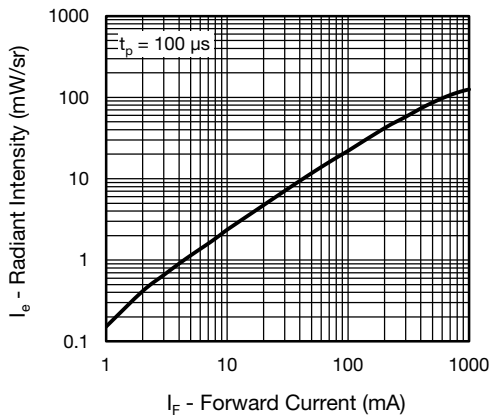


Fig. 6 - Radiant Intensity vs. Forward Current

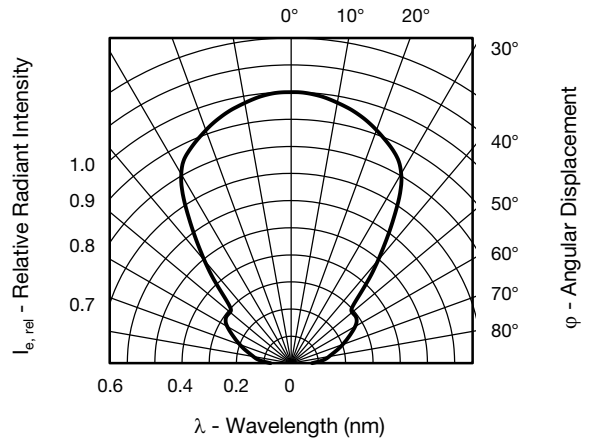


Fig. 9 - Relative Radiant Intensity vs. Angular Displacement

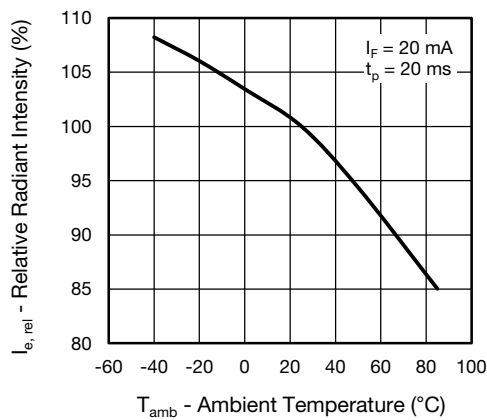


Fig. 7 - Relative Radiant Intensity vs. Ambient Temperature

**SOLDER PROFILE**

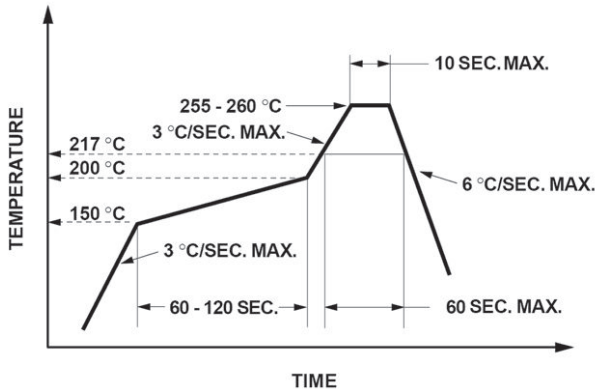


Fig. 10 - Lead (Pb)-free Reflow Solder Profile acc. J-STD-020

**DRYPACK**

Devices are packed in moisture barrier bags (MBB) to prevent the products from moisture absorption during transportation and storage. Each bag contains a desiccant.

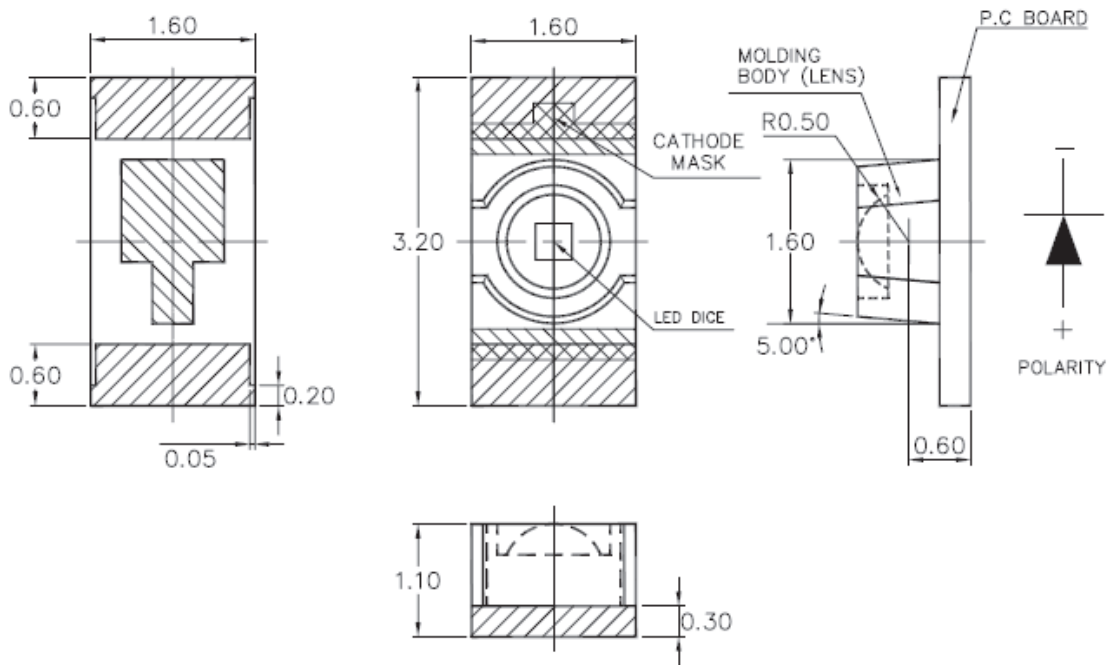
**FLOOR LIFE**

Floor life (time between soldering and removing from MBB) must not exceed the time indicated on MBB label:  
 Floor life: 168 h  
 Conditions:  $T_{amb} < 30\text{ °C}$ ,  $RH < 60\%$   
 Moisture sensitivity level 3, according to J-STD-020.

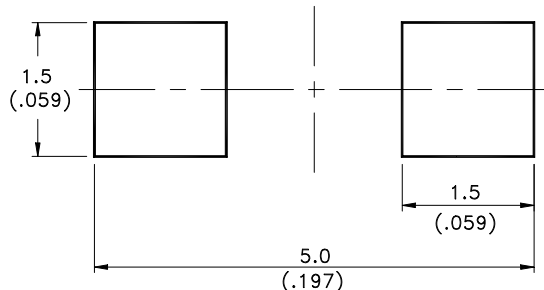
**DRYING**

In case of moisture absorption devices should be baked before soldering. Conditions see J-STD-020 or label.  
 Devices taped on reel dry using recommended conditions  
 192 h at 40 °C (+ 5 °C),  $RH < 5\%$ .

**PACKAGE DIMENSIONS** in millimeters: **VSMY12850**



**Recommended Solder Pad**





TAPING AND REEL DIMENSIONS in millimeters: VSMY12850





## Disclaimer

ALL PRODUCT, PRODUCT SPECIFICATIONS AND DATA ARE SUBJECT TO CHANGE WITHOUT NOTICE TO IMPROVE RELIABILITY, FUNCTION OR DESIGN OR OTHERWISE.

Vishay Intertechnology, Inc., its affiliates, agents, and employees, and all persons acting on its or their behalf (collectively, "Vishay"), disclaim any and all liability for any errors, inaccuracies or incompleteness contained in any datasheet or in any other disclosure relating to any product.

Vishay makes no warranty, representation or guarantee regarding the suitability of the products for any particular purpose or the continuing production of any product. To the maximum extent permitted by applicable law, Vishay disclaims (i) any and all liability arising out of the application or use of any product, (ii) any and all liability, including without limitation special, consequential or incidental damages, and (iii) any and all implied warranties, including warranties of fitness for particular purpose, non-infringement and merchantability.

Statements regarding the suitability of products for certain types of applications are based on Vishay's knowledge of typical requirements that are often placed on Vishay products in generic applications. Such statements are not binding statements about the suitability of products for a particular application. It is the customer's responsibility to validate that a particular product with the properties described in the product specification is suitable for use in a particular application. Parameters provided in datasheets and / or specifications may vary in different applications and performance may vary over time. All operating parameters, including typical parameters, must be validated for each customer application by the customer's technical experts. Product specifications do not expand or otherwise modify Vishay's terms and conditions of purchase, including but not limited to the warranty expressed therein.

Hyperlinks included in this datasheet may direct users to third-party websites. These links are provided as a convenience and for informational purposes only. Inclusion of these hyperlinks does not constitute an endorsement or an approval by Vishay of any of the products, services or opinions of the corporation, organization or individual associated with the third-party website. Vishay disclaims any and all liability and bears no responsibility for the accuracy, legality or content of the third-party website or for that of subsequent links.

Except as expressly indicated in writing, Vishay products are not designed for use in medical, life-saving, or life-sustaining applications or for any other application in which the failure of the Vishay product could result in personal injury or death. Customers using or selling Vishay products not expressly indicated for use in such applications do so at their own risk. Please contact authorized Vishay personnel to obtain written terms and conditions regarding products designed for such applications.

No license, express or implied, by estoppel or otherwise, to any intellectual property rights is granted by this document or by any conduct of Vishay. Product names and markings noted herein may be trademarks of their respective owners.