



## High Speed Infrared Emitting Diodes, 940 nm, GaAlAs, DH

VSMB2000X01



21725-4

VSMB2020X01



### DESCRIPTION

VSMB2000X01 series are infrared, 940 nm emitting diodes in GaAlAs (DH) technology with high radiant power and high speed, molded in clear, untinted plastic packages (with lens) for surface mounting (SMD).

### APPLICATIONS

- IrDA compatible data transmission
- Miniature light barrier
- Photointerrupters
- Optical switch
- Control and drive circuits
- Shaft encoders

### FEATURES

- Package type: surface mount
- Package form: GW, RGW
- Dimensions (L x W x H in mm): 2.3 x 2.3 x 2.8
- AEC-Q101 qualified
- Peak wavelength:  $\lambda_p = 940$  nm
- High reliability
- High radiant power
- High radiant intensity
- Angle of half intensity:  $\phi = \pm 12^\circ$
- Low forward voltage
- Suitable for high pulse current operation
- Terminal configurations: gullwing or reserve gullwing
- Package matches with detector VEMD2000X01 series
- Floor life: 4 weeks, MSL 2a, acc. J-STD-020
- Compliant to RoHS Directive 2002/95/EC and in accordance to WEEE 2002/96/EC



### Note

\*\* Please see document "Vishay Material Category Policy": [www.vishay.com/doc?99902](http://www.vishay.com/doc?99902)

PRODUCT SUMMARY				
COMPONENT	I <sub>e</sub> (mW/sr)	φ (deg)	λ <sub>p</sub> (nm)	t <sub>r</sub> (ns)
VSMB2000X01	40	± 12	940	15
VSMB2020X01	40	± 12	940	15

### Note

- Test conditions see table "Basic Characteristics"

ORDERING INFORMATION			
ORDERING CODE	PACKAGING	REMARKS	PACKAGE FORM
VSMB2000X01	Tape and reel	MOQ: 6000 pcs, 6000 pcs/reel	Reverse gullwing
VSMB2020X01	Tape and reel	MOQ: 6000 pcs, 6000 pcs/reel	Gullwing

### Note

- MOQ: minimum order quantity

ABSOLUTE MAXIMUM RATINGS (T <sub>amb</sub> = 25 °C, unless otherwise specified)				
PARAMETER	TEST CONDITION	SYMBOL	VALUE	UNIT
Reverse voltage		V <sub>R</sub>	5	V
Forward current		I <sub>F</sub>	100	mA
Peak forward current	t <sub>p</sub> /T = 0.5, t <sub>p</sub> = 100 μs	I <sub>FM</sub>	200	mA
Surge forward current	t <sub>p</sub> = 100 μs	I <sub>FSM</sub>	1	A
Power dissipation		P <sub>V</sub>	160	mW
Junction temperature		T <sub>j</sub>	100	°C
Operating temperature range		T <sub>amb</sub>	- 40 to + 85	°C
Storage temperature range		T <sub>stg</sub>	- 40 to + 100	°C
Soldering temperature	t ≤ 5 s	T <sub>sd</sub>	260	°C
Thermal resistance junction/ambient	J-STD-051, leads 7 mm, soldered on PCB	R <sub>thJA</sub>	250	K/W



Fig. 1 - Power Dissipation Limit vs. Ambient Temperature



Fig. 2 - Forward Current Limit vs. Ambient Temperature

<b>BASIC CHARACTERISTICS</b> (T <sub>amb</sub> = 25 °C, unless otherwise specified)						
PARAMETER	TEST CONDITION	SYMBOL	MIN.	TYP.	MAX.	UNIT
Forward voltage	I <sub>F</sub> = 100 mA, t <sub>p</sub> = 20 ms	V <sub>F</sub>	1.15	1.35	1.6	V
	I <sub>F</sub> = 1 A, t <sub>p</sub> = 100 μs	V <sub>F</sub>		2.2		V
Temperature coefficient of V <sub>F</sub>	I <sub>F</sub> = 1 mA	TK <sub>V<sub>F</sub></sub>		- 1.8		mV/K
	I <sub>F</sub> = 100 mA	TK <sub>V<sub>F</sub></sub>		- 1.1		mV/K
Reverse current	V <sub>R</sub> = 5 V	I <sub>R</sub>			10	μA
Junction capacitance	V <sub>R</sub> = 0 V, f = 1 MHz, E = 0 mW/cm <sup>2</sup>	C <sub>J</sub>		70		pF
Radiant intensity	I <sub>F</sub> = 100 mA, t <sub>p</sub> = 20 ms	I <sub>e</sub>	20	40	60	mW/sr
	I <sub>F</sub> = 1 A, t <sub>p</sub> = 100 μs	I <sub>e</sub>		330		mW/sr
Radiant power	I <sub>F</sub> = 100 mA, t <sub>p</sub> = 20 ms	φ <sub>e</sub>		40		mW
Temperature coefficient of radiant power	I <sub>F</sub> = 1 mA	TK <sub>φ<sub>e</sub></sub>		- 1.1		%/K
	I <sub>F</sub> = 100 mA	TK <sub>φ<sub>e</sub></sub>		- 0.51		%/K
Angle of half intensity		φ		± 12		deg
Peak wavelength	I <sub>F</sub> = 30 mA	λ <sub>p</sub>	920	940	960	nm
Spectral bandwidth	I <sub>F</sub> = 30 mA	Δλ		25		nm
Temperature coefficient of λ <sub>p</sub>	I <sub>F</sub> = 30 mA	TK <sub>λ<sub>p</sub></sub>		0.25		nm/K
Rise time	I <sub>F</sub> = 100 mA, 20 % to 80 %	t <sub>r</sub>		15		ns
Fall time	I <sub>F</sub> = 100 mA, 20 % to 80 %	t <sub>f</sub>		15		ns
Cut-off frequency	I <sub>DC</sub> = 70 mA, I <sub>AC</sub> = 30 mA pp	f <sub>c</sub>		23		MHz
Virtual source diameter		d		1.5		mm

## BASIC CHARACTERISTICS (T<sub>amb</sub> = 25 °C, unless otherwise specified)



Fig. 3 - Forward Current vs. Forward Voltage

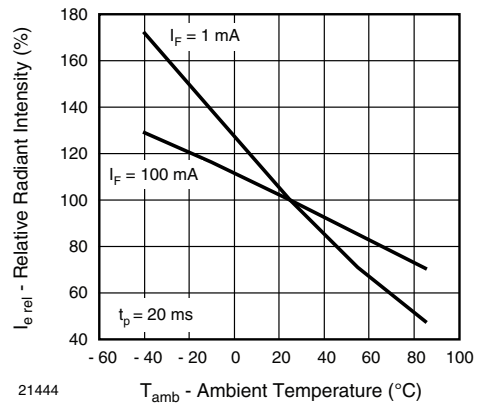

Fig. 6 - Relative Radiant Intensity vs. Ambient Temperature

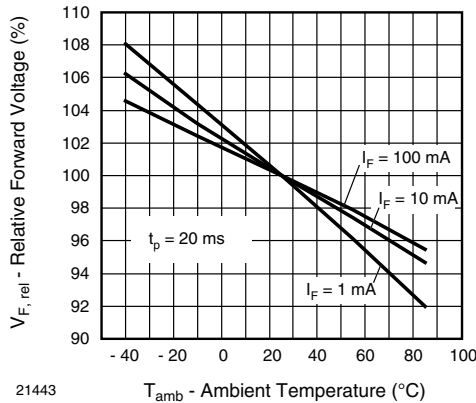

Fig. 4 - Relative Forward Voltage vs. Ambient Temperature

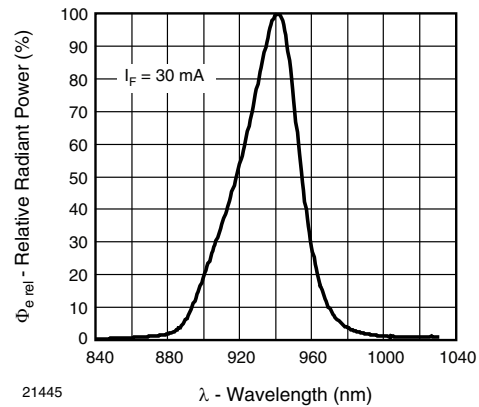

Fig. 7 - Relative Radiant Power vs. Wavelength

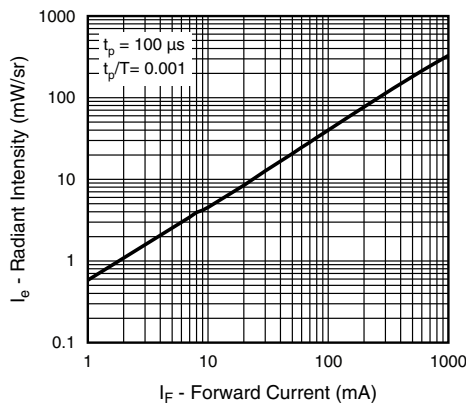

Fig. 5 - Radiant Intensity vs. Forward Current

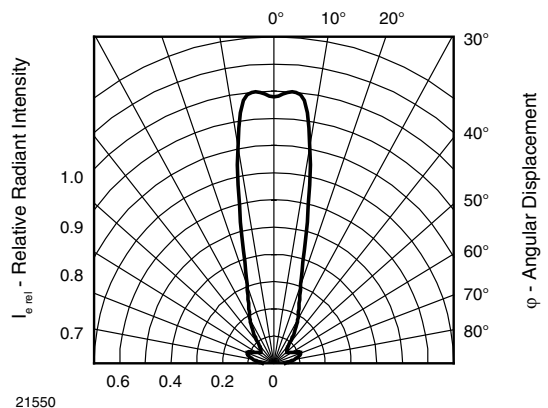

Fig. 8 - Relative Radiant Intensity vs. Angular Displacement



## SOLDER PROFILE



Fig. 9 - Lead (Pb)-free Reflow Solder Profile acc. J-STD-020

## DRYPACK

Devices are packed in moisture barrier bags (MBB) to prevent the products from moisture absorption during transportation and storage. Each bag contains a desiccant.

## FLOOR LIFE

Floor life (time between soldering and removing from MBB) must not exceed the time indicated on MBB label:

Floor life: 4 weeks

Conditions:  $T_{amb} < 30\text{ °C}$ , RH < 60 %

Moisture sensitivity level 2a, acc. to J-STD-020.

## DRYING

In case of moisture absorption devices should be baked before soldering. Conditions see J-STD-020 or label. Devices taped on reel dry using recommended conditions 192 h at 40 °C (+ 5 °C), RH < 5 %.

## PACKAGE DIMENSIONS in millimeters: VSMB2000

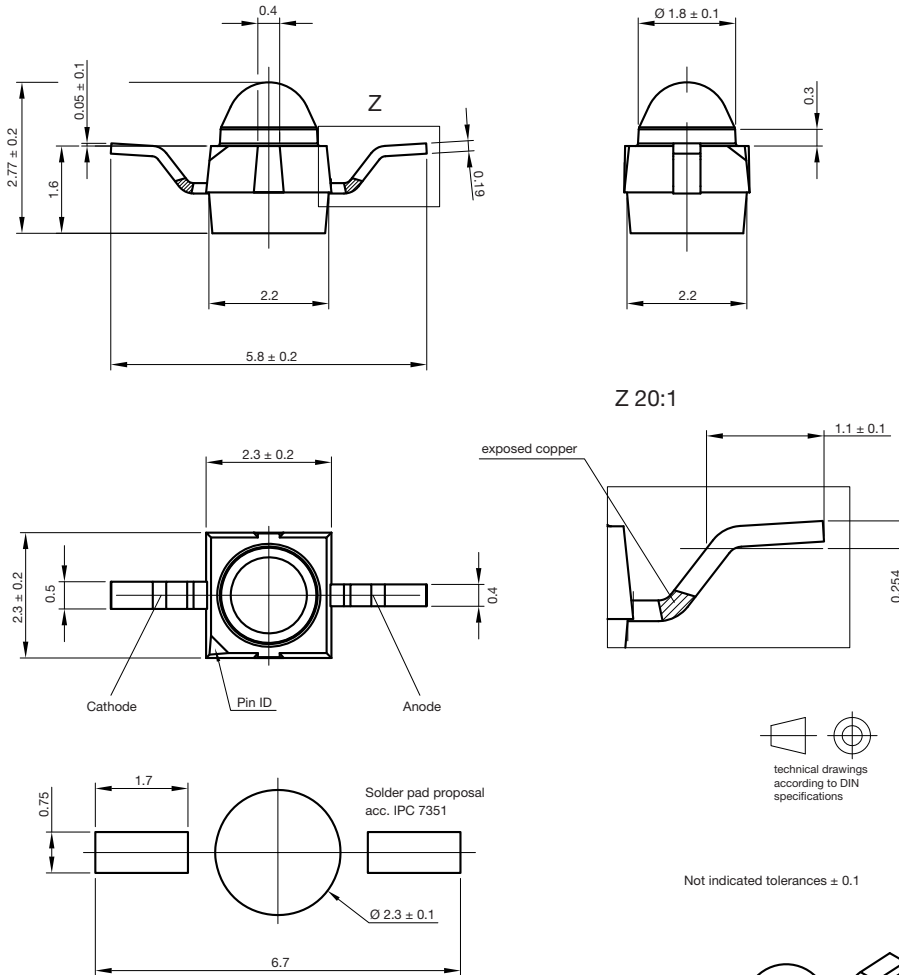

Drawing-No.: 6.544-5391.02-4  
Issue: 2; 18.03.10  
21517

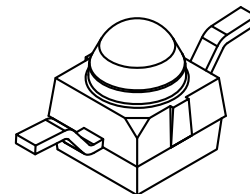



## PACKAGE DIMENSIONS in millimeters: VSMB2020

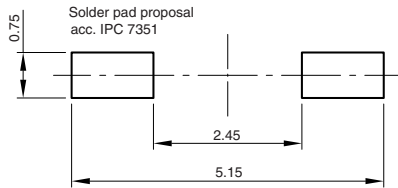
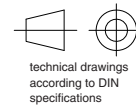
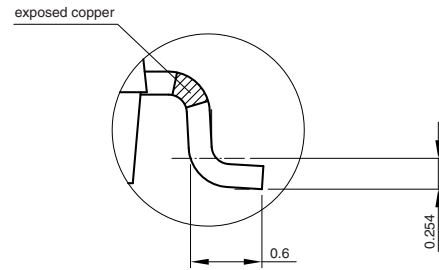
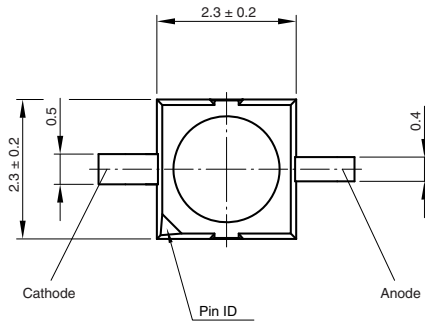

Not indicated tolerances ± 0.1



Drawing-No.: 6.544-5383.02-4  
Issue: 4; 18.03.10  
21488



**TAPING AND REEL DIMENSIONS** in millimeters: **VSMB2000**



Leader and trailer tape:

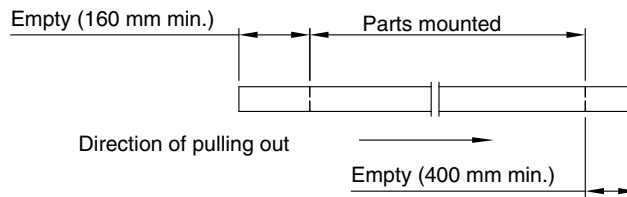

Terminal position in tape

Device	Lead I	Lead II
VENT2000	Collector	Emitter
VENT2500		Emitter
VEMD2000	Cathode	Anode
VEMD2500		
VSMB2000		
VSMG2000	Anode	Cathode
VSMY2850RG		

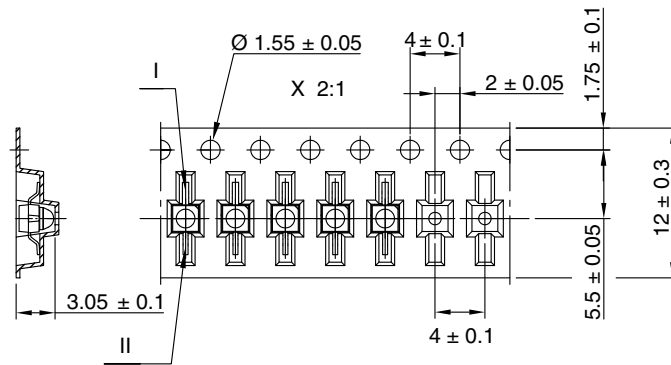

Drawing-No.: 9.800-5100.01-4  
 Issue: 2; 18.03.10  
 21572

## TAPING AND REEL DIMENSIONS in millimeters: VSMB2020

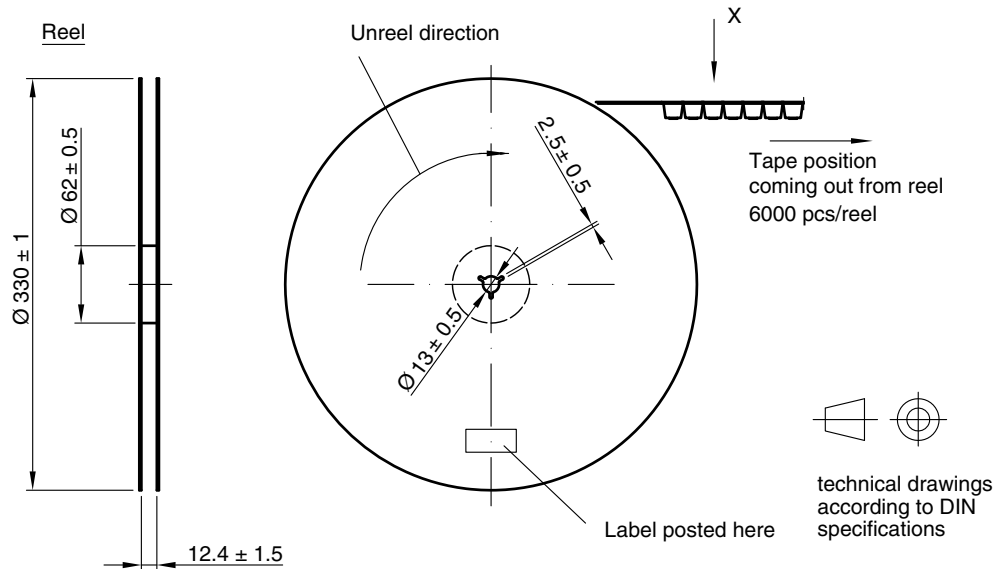

### Leader and trailer tape:

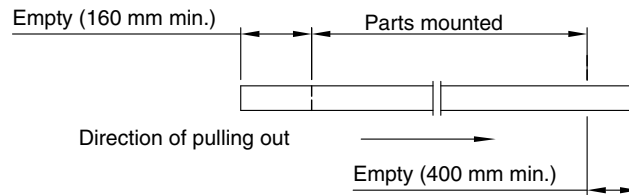

### Terminal position in tape

Device	Lead I	Lead II
VENT2020	Collector	Emitter
VENT2520		Emitter
VSMB2020	Cathode	Anode
VSMG2020		
VEMD2020		
VEMD2520		
VSMY2850G	Anode	Cathode

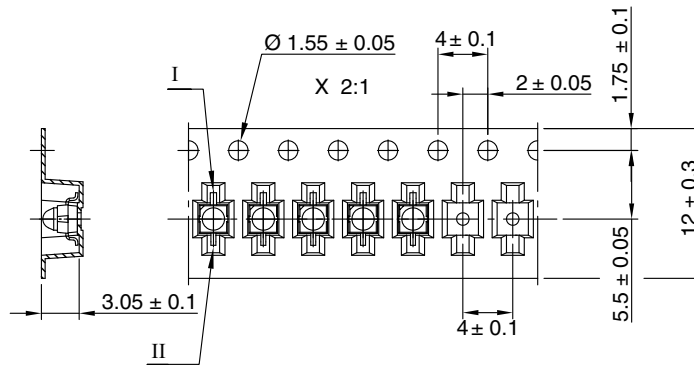

Drawing-No.: 9.800-5091.01-4

Issue: 3; 18.03.10

21571



## Disclaimer

ALL PRODUCT, PRODUCT SPECIFICATIONS AND DATA ARE SUBJECT TO CHANGE WITHOUT NOTICE TO IMPROVE RELIABILITY, FUNCTION OR DESIGN OR OTHERWISE.

Vishay Intertechnology, Inc., its affiliates, agents, and employees, and all persons acting on its or their behalf (collectively, "Vishay"), disclaim any and all liability for any errors, inaccuracies or incompleteness contained in any datasheet or in any other disclosure relating to any product.

Vishay makes no warranty, representation or guarantee regarding the suitability of the products for any particular purpose or the continuing production of any product. To the maximum extent permitted by applicable law, Vishay disclaims (i) any and all liability arising out of the application or use of any product, (ii) any and all liability, including without limitation special, consequential or incidental damages, and (iii) any and all implied warranties, including warranties of fitness for particular purpose, non-infringement and merchantability.

Statements regarding the suitability of products for certain types of applications are based on Vishay's knowledge of typical requirements that are often placed on Vishay products in generic applications. Such statements are not binding statements about the suitability of products for a particular application. It is the customer's responsibility to validate that a particular product with the properties described in the product specification is suitable for use in a particular application. Parameters provided in datasheets and / or specifications may vary in different applications and performance may vary over time. All operating parameters, including typical parameters, must be validated for each customer application by the customer's technical experts. Product specifications do not expand or otherwise modify Vishay's terms and conditions of purchase, including but not limited to the warranty expressed therein.

Hyperlinks included in this datasheet may direct users to third-party websites. These links are provided as a convenience and for informational purposes only. Inclusion of these hyperlinks does not constitute an endorsement or an approval by Vishay of any of the products, services or opinions of the corporation, organization or individual associated with the third-party website. Vishay disclaims any and all liability and bears no responsibility for the accuracy, legality or content of the third-party website or for that of subsequent links.

Except as expressly indicated in writing, Vishay products are not designed for use in medical, life-saving, or life-sustaining applications or for any other application in which the failure of the Vishay product could result in personal injury or death. Customers using or selling Vishay products not expressly indicated for use in such applications do so at their own risk. Please contact authorized Vishay personnel to obtain written terms and conditions regarding products designed for such applications.

No license, express or implied, by estoppel or otherwise, to any intellectual property rights is granted by this document or by any conduct of Vishay. Product names and markings noted herein may be trademarks of their respective owners.