

## Single Thyristor (MAGN-A-PAK Block Power Module), 500 A



MAGN-A-PAK Block

### FEATURES

- Electrically isolated base plate
- 3000 V<sub>RMS</sub> isolating voltage
- Industrial standard package
- Simplified mechanical designs, rapid assembly
- High surge capability
- Large creepage distances
- UL approved file E78996
- Material categorization: for definitions of compliance please see [www.vishay.com/doc?99912](http://www.vishay.com/doc?99912)



**RoHS**  
COMPLIANT

PRIMARY CHARACTERISTICS	
I <sub>T(AV)</sub>	500 A
Type	Modules - thyristor, standard
Package	MAGN-A-PAK block

### APPLICATIONS

- Battery chargers
- Welders
- Power converters
- Alternators

MAJOR RATINGS AND CHARACTERISTICS			
SYMBOL	CHARACTERISTICS	VALUES	UNITS
V <sub>DRM</sub> /V <sub>RRM</sub>		800	V
I <sub>T(AV)</sub>	76 °C	500	A
I <sub>T(RMS)</sub>		785	
I <sub>TSM</sub>	50 Hz	14 000	
	60 Hz	14 658	
I <sup>2</sup> t	50 Hz	980	kA <sup>2</sup> s
	60 Hz	894	
I <sup>2</sup> √t		9800	kA <sup>2</sup> √s
T <sub>J</sub>	Range	-40 to +130	°C

### ELECTRICAL SPECIFICATIONS

VOLTAGE RATINGS			
TYPE NUMBER	V <sub>RRM</sub> /V <sub>DRM</sub> , MAXIMUM REPETITIVE PEAK REVERSE VOLTAGE V	V <sub>RSM</sub> /V <sub>DSM</sub> , MAXIMUM NON-REPETITIVE PEAK REVERSE VOLTAGE V	I <sub>RRM</sub> /I <sub>DRM</sub> AT 130 °C mA
VS-VSKS500/08PbF	800	900	80



ON-STATE CONDUCTION						
PARAMETER	SYMBOL	TEST CONDITIONS		VALUES	UNITS	
Maximum average on-state current at case temperature	$I_{T(AV)}$	180° conduction half sine wave		500	A	
				76	°C	
Maximum RMS on-state current	$I_{T(RMS)}$	As AC switch		785	A	
Maximum peak, one-cycle on-state, non-repetitive surge current	$I_{TSM}$	t = 10 ms	No voltage reappplied	16 646		
		t = 8.3 ms		17 430		
		t = 10 ms	100 % $V_{RRM}$ reappplied	14 000		
		t = 8.3 ms		14 658		
Maximum $I^2t$ for fusing	$I^2t$	t = 10 ms	No voltage reappplied	1385		kA <sup>2</sup> s
		t = 8.3 ms		1265		
		t = 10 ms	100 % $V_{RRM}$ reappplied	894		
		t = 8.3 ms		894		
Maximum $I^2\sqrt{t}$ for fusing	$I^2\sqrt{t}$	t = 0.1 ms to 10 ms, no voltage reappplied		1385	kA <sup>2</sup> √s	
Low level value of threshold voltage	$V_{T(TO)1}$	(16.7 % $\times \pi \times I_{T(AV)} < I < \pi \times I_{T(AV)}$ ), $T_J$ maximum		0.6839	V	
High level value of threshold voltage	$V_{T(TO)2}$	(I > $\pi \times I_{T(AV)}$ ), $T_J$ maximum		0.7598		
Low level value on-state slope resistance	$r_{t1}$	(16.7 % $\times \pi \times I_{T(AV)} < I < \pi \times I_{T(AV)}$ ), $T_J$ maximum		0.393	mΩ	
High level value on-state slope resistance	$r_{t2}$	(I > $\pi \times I_{T(AV)}$ ), $T_J$ maximum		0.389		
Maximum on-state voltage drop	$V_{TM}$	$T_J = 25\text{ °C}$ , $I_{pk} = 500\text{ A}$		1.1	V	

SWITCHING					
PARAMETER	SYMBOL	TEST CONDITIONS		VALUES	UNITS
Typical delay time	$t_d$	Gate current 1 A, $di_g/dt = 1\text{ A}/\mu\text{s}$ , $V_d = 0.67\% V_{DRM}$ , $T_J = 25\text{ °C}$ , $I_t = 400\text{ A}$		1.3	μs
Typical turn-off time	$t_q$	$I_{TM} = 750\text{ A}$ , $T_J = T_J$ maximum, $di/dt = 60\text{ A}/\mu\text{s}$ , $V_R = 50\text{ V}$ , $dV/dt = 20\text{ V}/\mu\text{s}$ , Gate 0 V 100 Ω, $t_p = 500\text{ μs}$		200	

BLOCKING					
PARAMETER	SYMBOL	TEST CONDITIONS		VALUES	UNITS
Maximum critical rate of rise of off-state voltage	dV/dt	$T_J = T_J$ maximum linear to 67 % rated $V_{DRM}$		500	V/μs
Maximum peak reverse and off-state leakage current	$I_{DRM}$ , $I_{RRM}$	$T_J = T_J$ maximum, rated $V_{DRM}/V_{RRM}$ applied		80	mA
RMS insulation voltage	$V_{INS}$	50 Hz, circuit to base, all terminal shorted, t = 1 s		3000	V



TRIGGERING				
PARAMETER	SYMBOL	TEST CONDITIONS	VALUES	UNITS
Maximum peak gate power	$P_{GM}$	$T_J = T_J$ maximum, $t_p \leq 5$ ms	10.0	W
Maximum average gate power	$P_{G(AV)}$	$T_J = T_J$ maximum, $f = 50$ Hz, $d\% = 50$	2.0	
Maximum peak positive gate current	$I_{GM}$	$T_J = T_J$ maximum, $t_p \leq 5$ ms	3.0	A
Maximum required DC gate voltage to trigger	$V_{GT}$	$T_J = 25$ °C Anode supply: 12 V resistive load	3	V
Maximum required DC gate current to trigger	$I_{GT}$		200	mA
Maximum holding current	$I_H$		600	
Maximum peak positive gate voltage	$+V_{GM}$	$T_J = T_J$ maximum, $t_p \leq 5$ ms	20	V
Maximum peak negative gate voltage	$-V_{GM}$		5.0	
DC gate voltage not to trigger	$V_{GD}$	$T_J = T_J$ maximum Maximum gate current/voltage not to trigger is the maximum value which will not trigger any unit with rated $V_{DRM}$ anode to cathode applied	0.30	V
DC gate current not to trigger	$I_{GD}$		10	mA
Maximum non-repetitive rate of rise of turned-on current	$di/dt$	Gate drive 20 V, 20 $\Omega$ , $t_r \leq 1$ $\mu$ s $T_J = T_J$ maximum, anode voltage $\leq 80$ % $V_{DRM}$ , $I_t = 400$ A	1000	A/ $\mu$ s

THERMAL AND MECHANICAL SPECIFICATIONS				
PARAMETER	SYMBOL	TEST CONDITIONS	VALUES	UNITS
Maximum junction operating and storage temperature range	$T_J, T_{Stg}$		-40 to +130	°C
Maximum thermal resistance, junction to case per junction	$R_{thJC}$	DC operation	0.08	K/W
Maximum thermal resistance, case to heatsink per module	$R_{thCS}$	Mounting surface smooth, flat and greased	0.035	
Mounting torque $\pm 10$ %	MAGN-A-PAK block to heatsink	A mounting compound is recommended and the torque should be rechecked after a period of 3 h to allow for the spread of the compound. Lubricated threads.	6 to 8	Nm
	busbar to MAGN-A-PAK block		12 to 15	
Approximate weight			430	g
			15.3	oz.
Case style			MAGN-A-PAK block	

$\Delta R$ CONDUCTION PER JUNCTION											
DEVICES	SINUSOIDAL CONDUCTION AT $T_J$ MAXIMUM					RECTANGULAR CONDUCTION AT $T_J$ MAXIMUM					UNITS
	180°	120°	90°	60°	30°	180°	120°	90°	60°	30°	
VS-VSKS500	0.013	0.0148	0.018	0.026	0.044	0.082	0.0142	0.019	0.027	0.044	K/W

**Note**

- Table shows the increment of thermal resistance  $R_{thJC}$  when devices operate at different conduction angles than DC

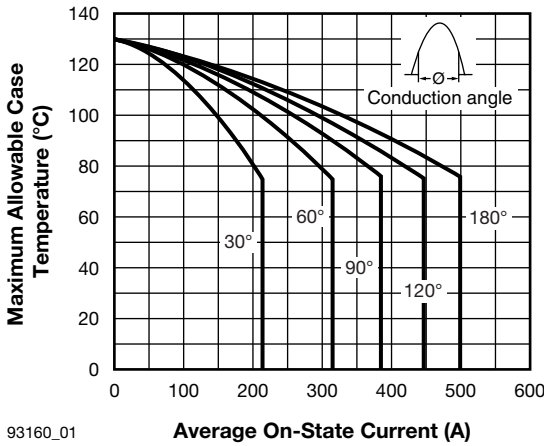

Fig. 1 - Current Rating Characteristics

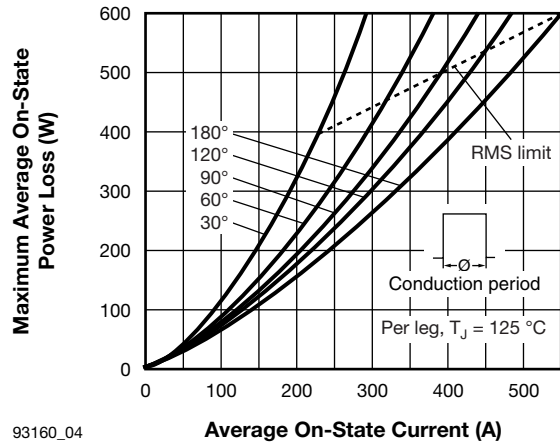

Fig. 4 - On-State Power Loss Characteristics

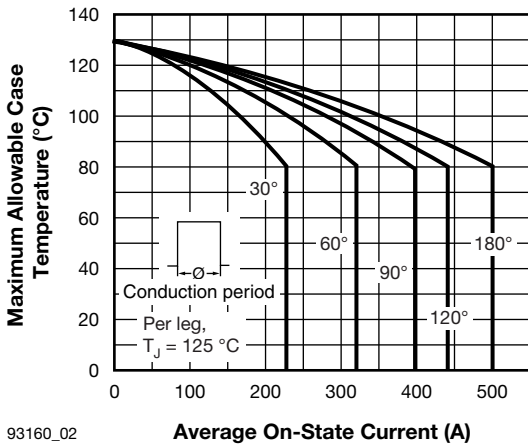

Fig. 2 - Current Rating Characteristics

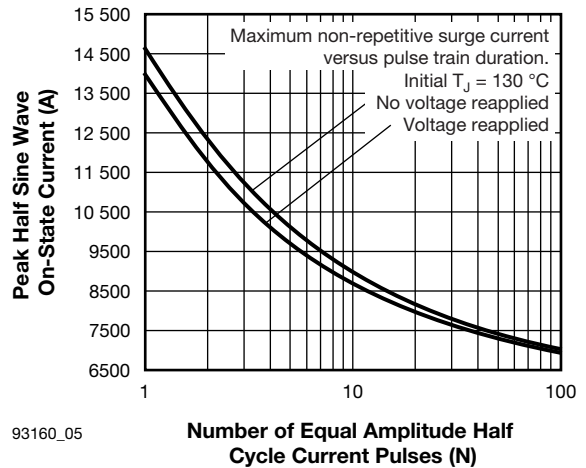

Fig. 5 - Maximum Non-Repetitive Surge Current

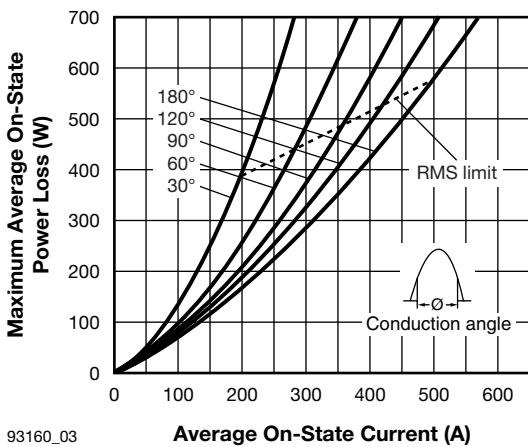

Fig. 3 - On-State Power Loss Characteristics

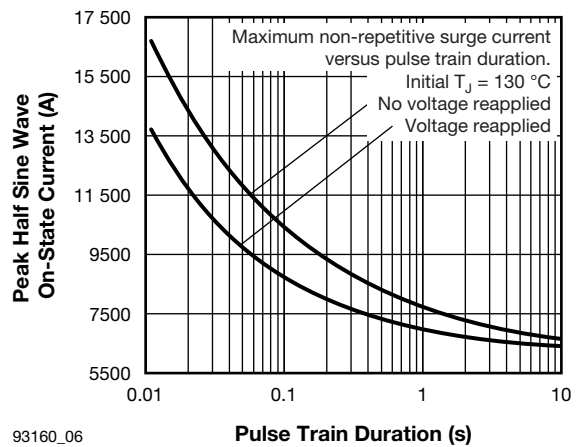

Fig. 6 - Maximum Non-Repetitive Surge Current

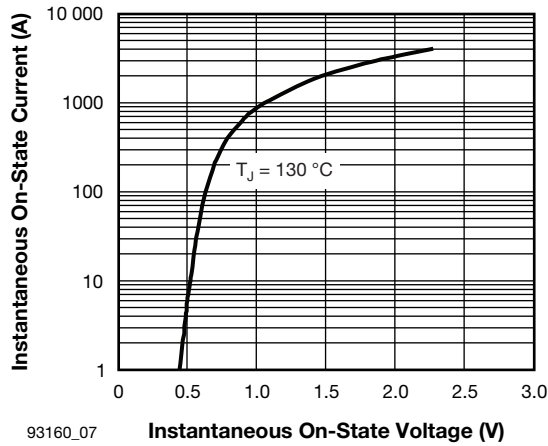

Fig. 7 - On-State Voltage Drop Characteristics

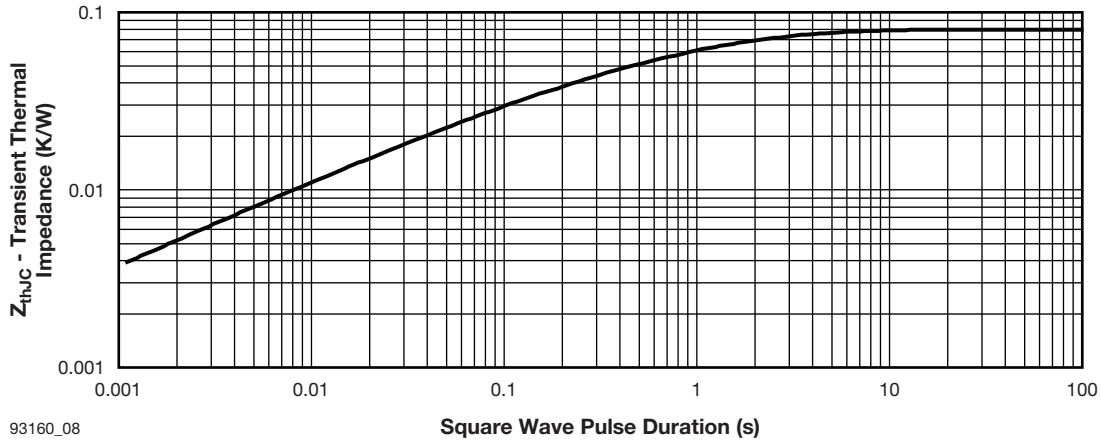

Fig. 8 - Thermal Impedance  $Z_{thJC}$  Characteristics

**ORDERING INFORMATION TABLE**

Device code	<b>VS-</b>	<b>VSK</b>	<b>S</b>	<b>500</b>	<b>/</b>	<b>08</b>	<b>PbF</b>
	①	②	③	④		⑤	⑥

- 1** - Vishay Semiconductors product
- 2** - Module type
- 3** - Circuit configuration (S = single SCR)
- 4** - Current rating (500 = 500 A)
- 5** - Voltage rating (08 = 800 V)
- 6** - PbF = lead (Pb)-free



CIRCUIT CONFIGURATION	
CIRCUIT DESCRIPTION	CIRCUIT DRAWING
Single SCR	

LINKS TO RELATED DOCUMENTS	
Dimensions	<a href="http://www.vishay.com/doc?95379">www.vishay.com/doc?95379</a>

## Thyristor MAP Block

**DIMENSIONS** in millimeters

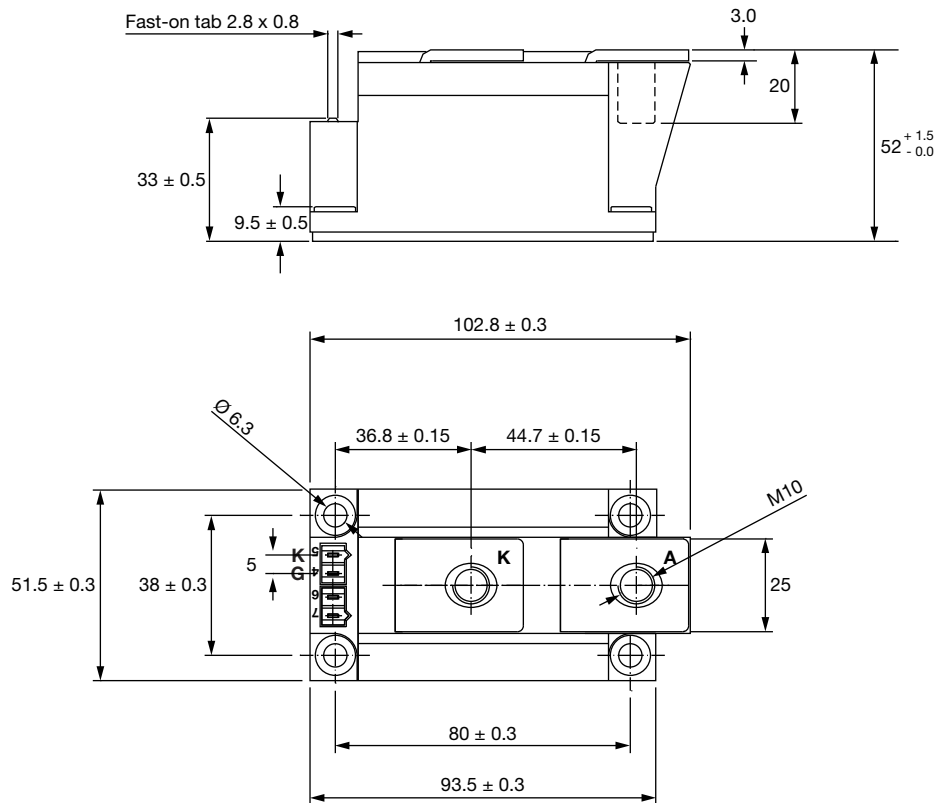

**Notes**

- Dimensions are nominal
- Full engineering drawings are available on request



## Disclaimer

ALL PRODUCT, PRODUCT SPECIFICATIONS AND DATA ARE SUBJECT TO CHANGE WITHOUT NOTICE TO IMPROVE RELIABILITY, FUNCTION OR DESIGN OR OTHERWISE.

Vishay Intertechnology, Inc., its affiliates, agents, and employees, and all persons acting on its or their behalf (collectively, "Vishay"), disclaim any and all liability for any errors, inaccuracies or incompleteness contained in any datasheet or in any other disclosure relating to any product.

Vishay makes no warranty, representation or guarantee regarding the suitability of the products for any particular purpose or the continuing production of any product. To the maximum extent permitted by applicable law, Vishay disclaims (i) any and all liability arising out of the application or use of any product, (ii) any and all liability, including without limitation special, consequential or incidental damages, and (iii) any and all implied warranties, including warranties of fitness for particular purpose, non-infringement and merchantability.

Statements regarding the suitability of products for certain types of applications are based on Vishay's knowledge of typical requirements that are often placed on Vishay products in generic applications. Such statements are not binding statements about the suitability of products for a particular application. It is the customer's responsibility to validate that a particular product with the properties described in the product specification is suitable for use in a particular application. Parameters provided in datasheets and / or specifications may vary in different applications and performance may vary over time. All operating parameters, including typical parameters, must be validated for each customer application by the customer's technical experts. Product specifications do not expand or otherwise modify Vishay's terms and conditions of purchase, including but not limited to the warranty expressed therein.

Hyperlinks included in this datasheet may direct users to third-party websites. These links are provided as a convenience and for informational purposes only. Inclusion of these hyperlinks does not constitute an endorsement or an approval by Vishay of any of the products, services or opinions of the corporation, organization or individual associated with the third-party website. Vishay disclaims any and all liability and bears no responsibility for the accuracy, legality or content of the third-party website or for that of subsequent links.

Except as expressly indicated in writing, Vishay products are not designed for use in medical, life-saving, or life-sustaining applications or for any other application in which the failure of the Vishay product could result in personal injury or death. Customers using or selling Vishay products not expressly indicated for use in such applications do so at their own risk. Please contact authorized Vishay personnel to obtain written terms and conditions regarding products designed for such applications.

No license, express or implied, by estoppel or otherwise, to any intellectual property rights is granted by this document or by any conduct of Vishay. Product names and markings noted herein may be trademarks of their respective owners.