

FRED Pt[®] Gen 4 Doubler Ultrafast Diode, 500 A (INT-A-PAK Power Modules)



INT-A-PAK

**RoHS
COMPLIANT**

FEATURES

- Gen 4 FRED Pt[®] dices technology
- Ultrasoft reverse recovery characteristics
- Low I_{RRM} and reverse recovery charge
- Very low forward voltage drop
- 175 °C operating junction temperature
- UL approved file E78996 for application with maximum case temperature up to 140 °C
- Large creepage distances
- Designed and qualified for industrial level
- Material categorization: for definitions of compliance please see www.vishay.com/doc?99912

DESCRIPTION

Gen 4 FRED Pt technology, state of the art, ultra low V_F , soft switching optimized for IGBT F/W diode.

The minimized conduction loss, optimized storage charge, and low recovery current, minimized the switching losses and reduce the over dissipation in the switching element and snubbers.

PRIMARY CHARACTERISTICS	
V_R	600 V
$I_{F(AV)}$ at T_C	500 A at 55 °C
t_{rr} at 25 °C	104 ns
Type	Modules - diode, FRED Pt [®]
Package	INT-A-PAK
Circuit configuration	Diode doubler circuit

ABSOLUTE MAXIMUM RATINGS				
PARAMETER	SYMBOL	TEST CONDITIONS	MAX.	UNITS
Cathode to anode voltage	V_R		600	V
Continuous forward current	I_F	$T_C = 25\text{ °C}$	772	A
		$T_C = 90\text{ °C}$	519	
Single pulse forward current	I_{FSM}	$t_p = 10\text{ ms}$, 50 Hz, sine half wave, initial $T_J = 175\text{ °C}$	4140	
Maximum power dissipation	P_D	$T_C = 25\text{ °C}$	1363	W
		$T_C = 90\text{ °C}$	772	
Operating junction temperature range	T_J		-40 to +175	°C
Storage temperature range	T_{Stg}		-40 to +150	
RMS insulation voltage	V_{INS}	50 Hz, circuit to base, all terminals shorted, $t = 1\text{ s}$	3500	V

ELECTRICAL SPECIFICATIONS ($T_J = 25\text{ °C}$ unless otherwise specified)						
PARAMETER	SYMBOL	TEST CONDITIONS	MIN.	TYP.	MAX.	UNITS
Cathode to anode breakdown voltage	V_{BR}	$I_R = 500\text{ }\mu\text{A}$	600	-	-	V
Forward voltage drop	V_{FM}	$I_F = 250\text{ A}$	-	1.25	-	
		$I_F = 500\text{ A}$	-	1.45	1.66	
		$I_F = 250\text{ A}$, $T_J = 150\text{ °C}$	-	1.06	-	
		$I_F = 500\text{ A}$, $T_J = 150\text{ °C}$	-	1.35	-	
Reverse leakage current	I_{RM}	$V_R = 600\text{ V}$	-	10	-	μA
		$T_J = 150\text{ °C}$, $V_R = 600\text{ V}$	-	2.5	-	mA



DYNAMIC RECOVERY CHARACTERISTICS (T _J = 25 °C unless otherwise specified)							
PARAMETER	SYMBOL	TEST CONDITIONS		MIN.	TYP.	MAX.	UNITS
Reverse recovery time	t _{rr}	T _J = 25 °C	I _F = 150 A dI/dt = 1000 A/μs V _R = 400 V	-	104	-	ns
		T _J = 125 °C		-	193	-	
Peak recovery current	I _{rr}	T _J = 25 °C		-	59	-	A
		T _J = 125 °C		-	122	-	
Reverse recovery charge	Q _{rr}	T _J = 25 °C		-	3.5	-	μC
		T _J = 125 °C		-	13.8	-	

THERMAL - MECHANICAL SPECIFICATIONS				
PARAMETER	SYMBOL	TEST CONDITIONS	VALUES	UNITS
Maximum thermal resistance, junction to case per leg	R _{thJC}	DC operation	0.11	K/W
Typical thermal resistance, case to heat sink	R _{thCS}	Mounting surface, flat, smooth, and greased	0.035	
Mounting torque ± 10 %		A mounting compound is recommended and the torque should be rechecked after a period of 3 hours to allow the spread of the compound	4 to 6	Nm
Approximate weight			200	g
			7.1	oz.
Case style			INT-A-PAK	

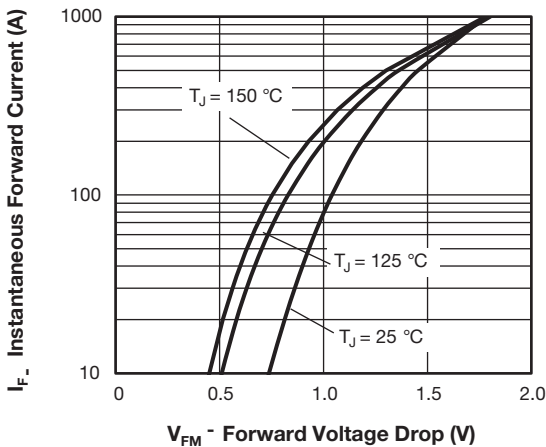

Fig. 1 - Typical Forward Voltage Drop Characteristics

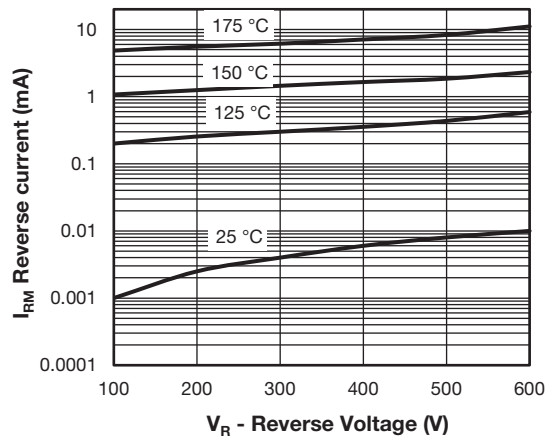

Fig. 2 - Typical Value of Reverse Current vs. Reverse Voltage

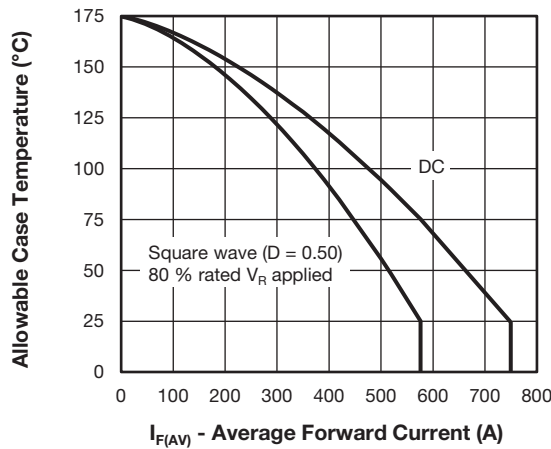

Fig. 3 - Maximum Allowable Case Temperature vs. Average Forward Current

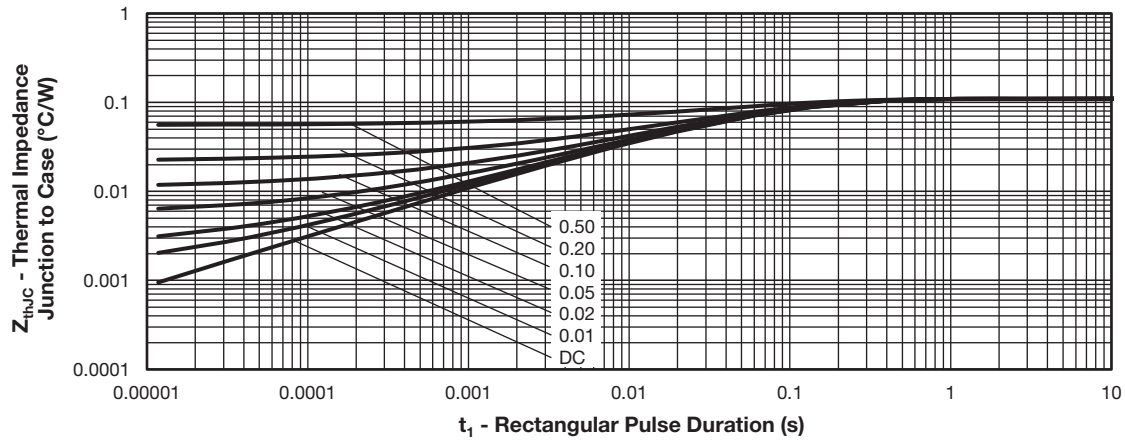

Fig. 4 - Maximum Thermal Impedance Z_{thJC} Characteristics

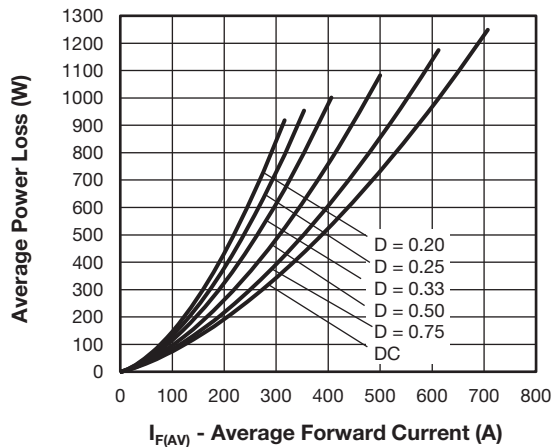

Fig. 5 - Forward Power Loss Characteristics

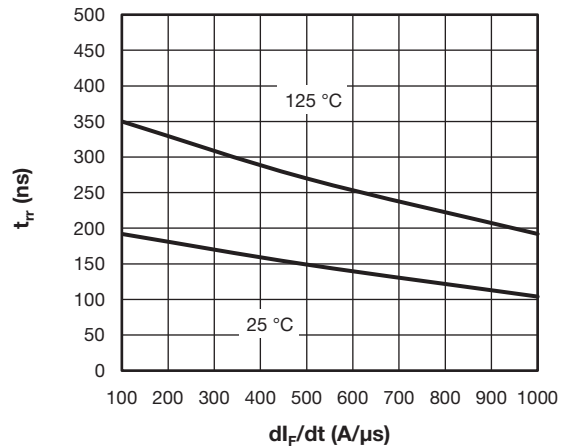
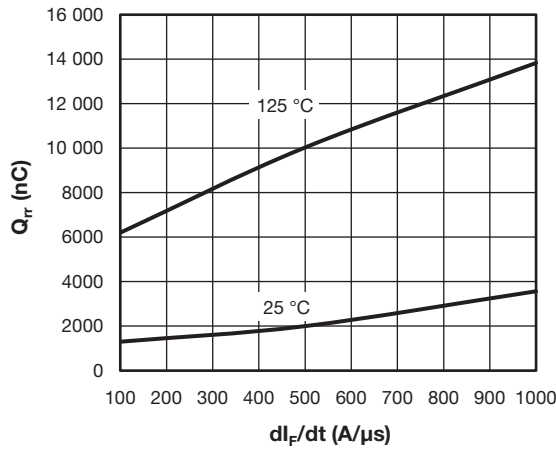
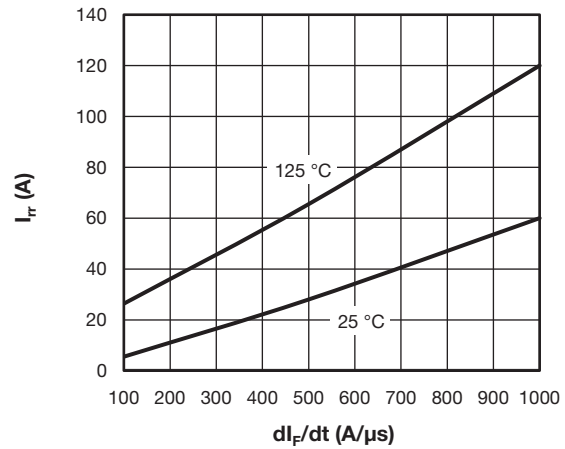

Fig. 6 - Typical Reverse Recovery Time vs. di_F/dt
 $I_{FM} = 150 \text{ A}, V_R = 300 \text{ V}$

 Fig. 7 - Typical Reverse Recovery Charge vs. di_F/dt
 $I_{FM} = 150\text{ A}$, $V_R = 300\text{ V}$

 Fig. 8 - Typical Reverse Recovery Current vs. di_F/dt
 $I_{FM} = 150\text{ A}$, $V_R = 300\text{ V}$
ORDERING INFORMATION TABLE

Device code	VS-VS	KD	F	500	06	PbF
	①	②	③	④	⑤	⑥

- 1** - Vishay Semiconductors product
- 2** - Circuit configuration: KD = doubler circuit
- 3** - F = FRED Pt[®] ultrafast diode
- 4** - Current rating (500 = 500 A)
- 5** - Voltage rating (06 = 600 V)
- 6** - PbF = lead (Pb)-free

CIRCUIT CONFIGURATION		
CIRCUIT	CIRCUIT CONFIGURATION CODE	CIRCUIT DRAWING
Diode doubler circuit	KD	KD reversed polarity



DIMENSIONS in millimeters (inches)

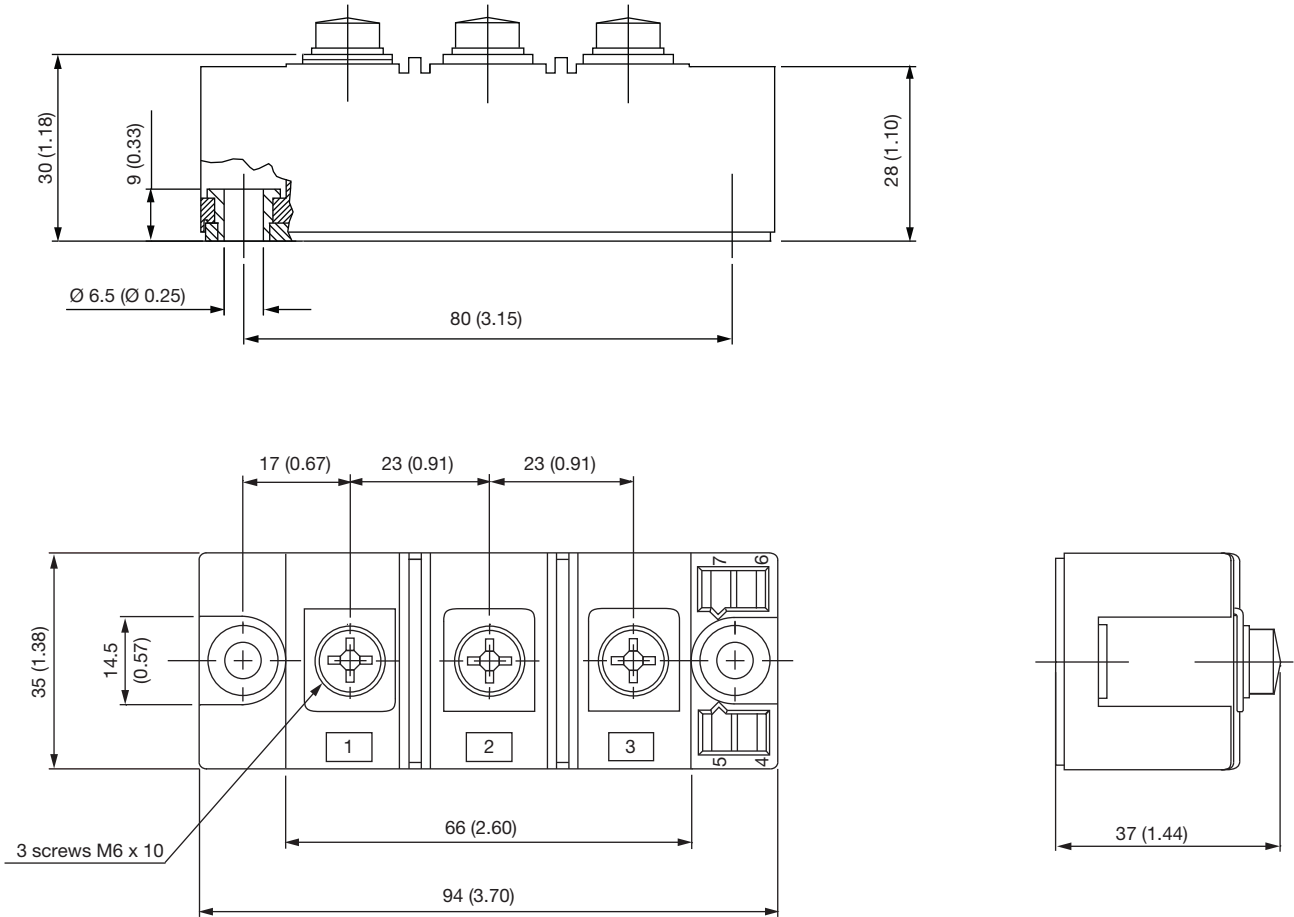

INT-A-PAK DBC

DIMENSIONS in millimeters (inches)





Disclaimer

ALL PRODUCT, PRODUCT SPECIFICATIONS AND DATA ARE SUBJECT TO CHANGE WITHOUT NOTICE TO IMPROVE RELIABILITY, FUNCTION OR DESIGN OR OTHERWISE.

Vishay Intertechnology, Inc., its affiliates, agents, and employees, and all persons acting on its or their behalf (collectively, "Vishay"), disclaim any and all liability for any errors, inaccuracies or incompleteness contained in any datasheet or in any other disclosure relating to any product.

Vishay makes no warranty, representation or guarantee regarding the suitability of the products for any particular purpose or the continuing production of any product. To the maximum extent permitted by applicable law, Vishay disclaims (i) any and all liability arising out of the application or use of any product, (ii) any and all liability, including without limitation special, consequential or incidental damages, and (iii) any and all implied warranties, including warranties of fitness for particular purpose, non-infringement and merchantability.

Statements regarding the suitability of products for certain types of applications are based on Vishay's knowledge of typical requirements that are often placed on Vishay products in generic applications. Such statements are not binding statements about the suitability of products for a particular application. It is the customer's responsibility to validate that a particular product with the properties described in the product specification is suitable for use in a particular application. Parameters provided in datasheets and / or specifications may vary in different applications and performance may vary over time. All operating parameters, including typical parameters, must be validated for each customer application by the customer's technical experts. Product specifications do not expand or otherwise modify Vishay's terms and conditions of purchase, including but not limited to the warranty expressed therein.

Hyperlinks included in this datasheet may direct users to third-party websites. These links are provided as a convenience and for informational purposes only. Inclusion of these hyperlinks does not constitute an endorsement or an approval by Vishay of any of the products, services or opinions of the corporation, organization or individual associated with the third-party website. Vishay disclaims any and all liability and bears no responsibility for the accuracy, legality or content of the third-party website or for that of subsequent links.

Except as expressly indicated in writing, Vishay products are not designed for use in medical, life-saving, or life-sustaining applications or for any other application in which the failure of the Vishay product could result in personal injury or death. Customers using or selling Vishay products not expressly indicated for use in such applications do so at their own risk. Please contact authorized Vishay personnel to obtain written terms and conditions regarding products designed for such applications.

No license, express or implied, by estoppel or otherwise, to any intellectual property rights is granted by this document or by any conduct of Vishay. Product names and markings noted herein may be trademarks of their respective owners.