



# Standard Recovery Diodes, (Hockey PUK Version), 3800 A



K-PUK (DO-200AC)

### FEATURES

- Wide current range
- High voltage ratings up to 1000 V
- High surge current capabilities
- Diffused junction
- Hockey PUK version
- Case style K-PUK (DO-200AC)
- Material categorization: for definitions of compliance please see [www.vishay.com/doc?99912](http://www.vishay.com/doc?99912)



RoHS  
COMPLIANT

### TYPICAL APPLICATIONS

- Converters
- Power supplies
- High power drives
- Auxiliary system supplies for traction applications

PRIMARY CHARACTERISTICS	
$I_{F(AV)}$	3800 A
Package	K-PUK (DO-200AC)
Circuit configuration	Single

MAJOR RATINGS AND CHARACTERISTICS			
PARAMETER	TEST CONDITIONS	VALUES	UNITS
$I_{F(AV)}$		3800	A
	$T_{hs}$	55	°C
$I_{F(RMS)}$		6230	A
	$T_{hs}$	25	°C
$I_{FSM}$	50 Hz	35 800	A
	60 Hz	37 500	
$I^2t$	50 Hz	6410	kA <sup>2</sup> s
	60 Hz	5850	
$V_{RRM}$	Range	400 to 1000	V
$T_J$		-40 to +180	°C

### ELECTRICAL SPECIFICATIONS

VOLTAGE RATINGS				
TYPE NUMBER	VOLTAGE CODE	$V_{RRM}$ , MAXIMUM REPETITIVE PEAK REVERSE VOLTAGE V	$V_{RSM}$ , MAXIMUM NON-REPETITIVE PEAK REVERSE VOLTAGE V	$I_{RRM}$ MAXIMUM AT $T_J = 180\text{ °C}$ mA
VS-SD3000C..K	04	400	500	75
	08	800	900	
	10	1000	1100	



FORWARD CONDUCTION					
PARAMETER	SYMBOL	TEST CONDITIONS		VALUES	UNITS
Maximum average forward current at heatsink temperature	$I_{F(AV)}$	180° conduction, half sine wave Double side (single side) cooled		3800 (1925)	A
				55 (85)	°C
Maximum RMS forward current	$I_{F(RMS)}$	25 °C heatsink temperature double side cooled		6230	A
Maximum peak, one-cycle forward, non-repetitive surge current	$I_{FSM}$	t = 10 ms	No voltage reappplied	35 800	
		t = 8.3 ms		37 500	
		t = 10 ms	100 % $V_{RRM}$ reappplied	30 100	
		t = 8.3 ms		31 500	
Maximum $I^2t$ for fusing	$I^2t$	t = 10 ms	No voltage reappplied	6410	kA <sup>2</sup> s
		t = 8.3 ms		5850	
		t = 10 ms	100 % $V_{RRM}$ reappplied	4530	
		t = 8.3 ms		4135	
Maximum $I^2\sqrt{t}$ for fusing	$I^2\sqrt{t}$	t = 0.1 to 10 ms, no voltage reappplied		64 100	kA <sup>2</sup> √s
Low level value of threshold voltage	$V_{F(TO)1}$	$(16.7 \% \times \pi \times I_{F(AV)} < I < \pi \times I_{F(AV)})$ , $T_J = T_J$ maximum		0.74	V
High level value of threshold voltage	$V_{F(TO)2}$	$(I > \pi \times I_{F(AV)})$ , $T_J = T_J$ maximum		0.86	
Low level value of forward slope resistance	$r_{f1}$	$(16.7 \% \times \pi \times I_{F(AV)} < I < \pi \times I_{F(AV)})$ , $T_J = T_J$ maximum		0.08	mW
High level value of forward slope resistance	$r_{f2}$	$(I > \pi \times I_{F(AV)})$ , $T_J = T_J$ maximum		0.07	
Maximum forward voltage drop	$V_{FM}$	$I_{pk} = 6000$ A, $T_J = T_J$ maximum $t_p = 10$ ms sinusoidal wave		1.22	V

THERMAL AND MECHANICAL SPECIFICATIONS					
PARAMETER	SYMBOL	TEST CONDITIONS		VALUES	UNITS
Maximum junction operating temperature range	$T_J$			-40 to +180	°C
Maximum storage temperature range	$T_{Stg}$			-55 to +200	
Maximum thermal resistance, junction to heatsink	$R_{thJ-hs}$	DC operation single side cooled		0.042	K/W
		DC operation double side cooled		0.020	
Mounting force, ± 10 %				22 250 (2250)	N (kg)
Approximate weight				425	g
Case style		See dimensions - link at the end of datasheet		K-PUK (DO-200AC)	

$\Delta R_{thJ-hs}$ CONDUCTION						
CONDUCTION ANGLE	SINUSOIDAL CONDUCTION		RECTANGULAR CONDUCTION		TEST CONDITIONS	UNITS
	SINGLE SIDE	DOUBLE SIDE	SINGLE SIDE	DOUBLE SIDE		
180°	0.002	0.002	0.001	0.001	$T_J = T_J$ maximum	K/W
120°	0.002	0.002	0.002	0.002		
90°	0.003	0.003	0.003	0.003		
60°	0.004	0.004	0.004	0.004		
30°	0.007	0.007	0.007	0.007		

**Note**

- The table above shows the increment of thermal resistance  $R_{thJ-hs}$  when devices operate at different conduction angles than DC

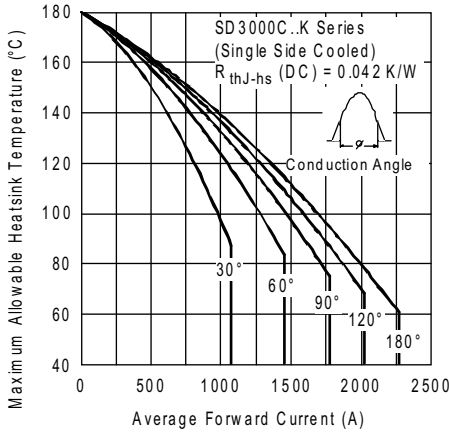

Fig. 1 - Current Ratings Characteristics

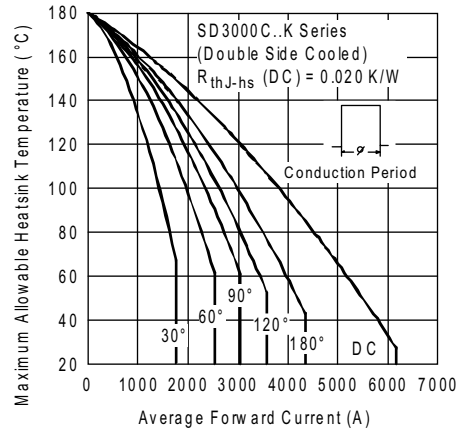

Fig. 4 - Current Ratings Characteristics

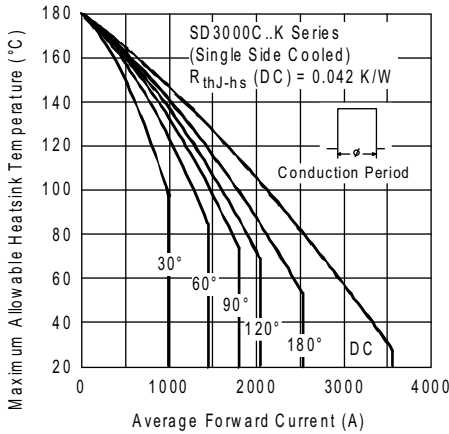

Fig. 2 - Current Ratings Characteristics

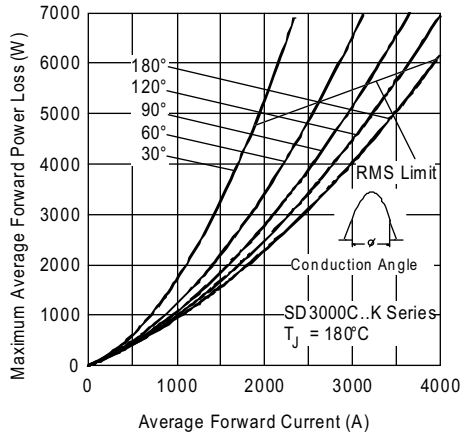

Fig. 5 - Forward Power Loss Characteristics

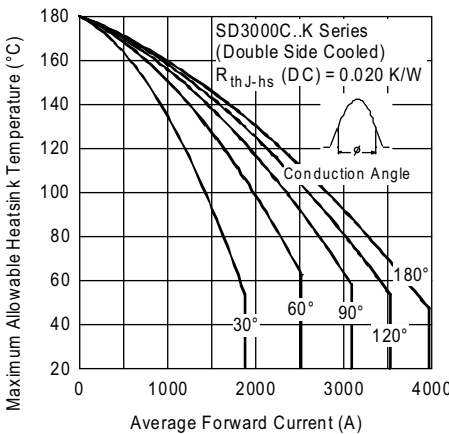

Fig. 3 - Current Ratings Characteristics

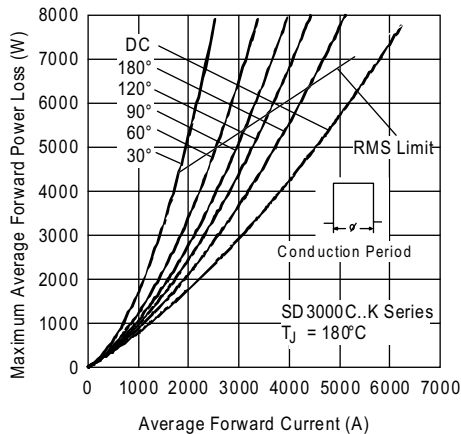

Fig. 6 - Forward Power Loss Characteristics

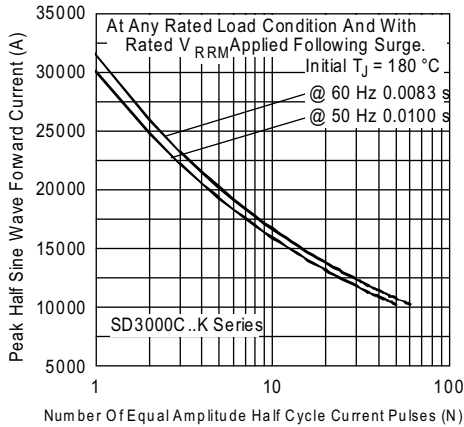

Fig. 7 - Maximum Non-Repetitive Surge Current Single and Double Side Cooled

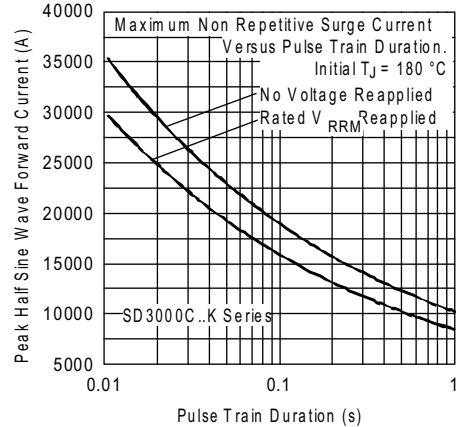

Fig. 8 - Maximum Non-Repetitive Surge Current Single and Double Side Cooled

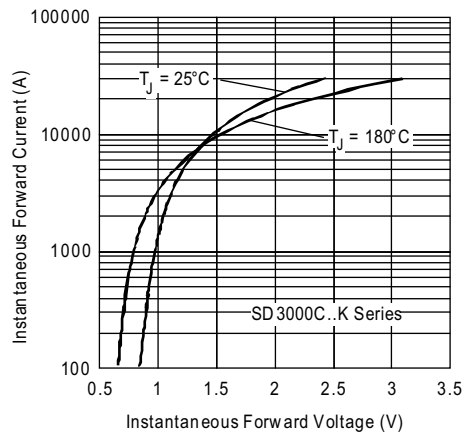

Fig. 9 - Forward Voltage Drop Characteristics

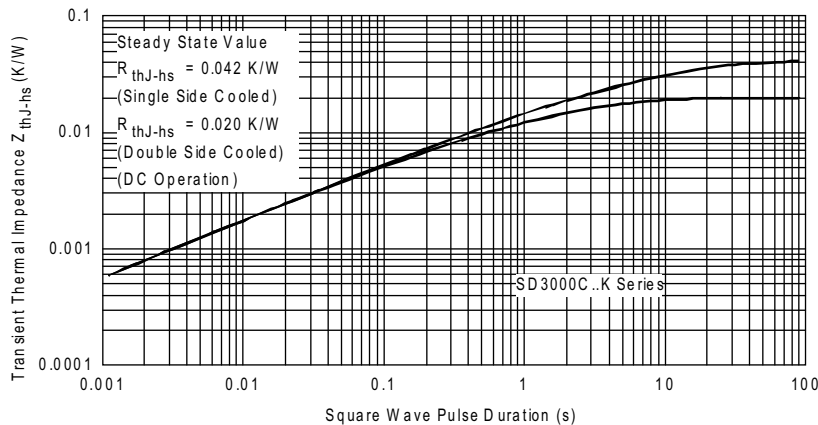
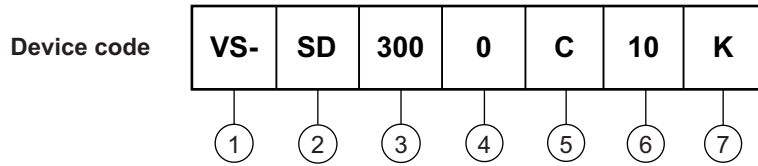

Fig. 10 - Thermal Impedance  $Z_{thJ-hs}$  Characteristics



## ORDERING INFORMATION TABLE



- 1** - Vishay Semiconductors product
- 2** - Diode
- 3** - Essential part number
- 4** - 0 = standard recovery
- 5** - C = ceramic PUK
- 6** - Voltage code x 100 =  $V_{RRM}$  (see Voltage Ratings table)
- 7** - K = PUK case K-PUK (DO-200AC)

LINKS TO RELATED DOCUMENTS	
Dimensions	<a href="http://www.vishay.com/doc?95247">www.vishay.com/doc?95247</a>



## K-PUK (DO-200AC)

**DIMENSIONS** in millimeters (inches)

3.5 (0.14) DIA. NOM. x  
1.8 (0.07) deep MIN. both ends

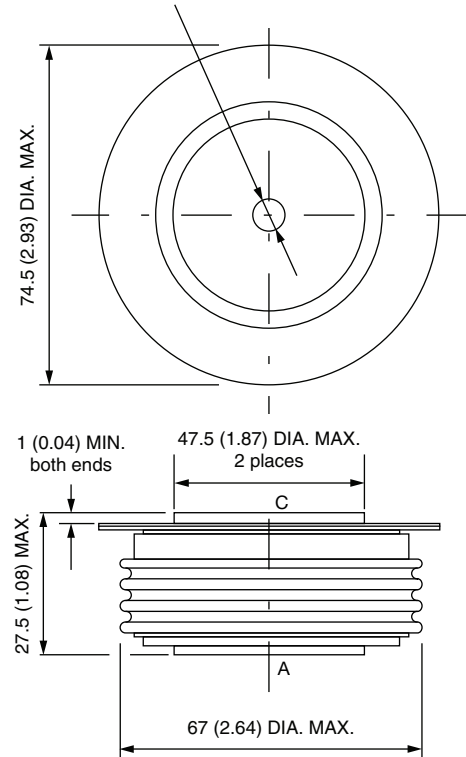

**Note:**

A = Anode

C = Cathode

Quote between upper and lower pole pieces has to be considered after application of mounting force (see Thermal and Mechanical Specifications)



## **Disclaimer**

ALL PRODUCT, PRODUCT SPECIFICATIONS AND DATA ARE SUBJECT TO CHANGE WITHOUT NOTICE TO IMPROVE RELIABILITY, FUNCTION OR DESIGN OR OTHERWISE.

Vishay Intertechnology, Inc., its affiliates, agents, and employees, and all persons acting on its or their behalf (collectively, "Vishay"), disclaim any and all liability for any errors, inaccuracies or incompleteness contained in any datasheet or in any other disclosure relating to any product.

Vishay makes no warranty, representation or guarantee regarding the suitability of the products for any particular purpose or the continuing production of any product. To the maximum extent permitted by applicable law, Vishay disclaims (i) any and all liability arising out of the application or use of any product, (ii) any and all liability, including without limitation special, consequential or incidental damages, and (iii) any and all implied warranties, including warranties of fitness for particular purpose, non-infringement and merchantability.

Statements regarding the suitability of products for certain types of applications are based on Vishay's knowledge of typical requirements that are often placed on Vishay products in generic applications. Such statements are not binding statements about the suitability of products for a particular application. It is the customer's responsibility to validate that a particular product with the properties described in the product specification is suitable for use in a particular application. Parameters provided in datasheets and / or specifications may vary in different applications and performance may vary over time. All operating parameters, including typical parameters, must be validated for each customer application by the customer's technical experts. Product specifications do not expand or otherwise modify Vishay's terms and conditions of purchase, including but not limited to the warranty expressed therein.

Hyperlinks included in this datasheet may direct users to third-party websites. These links are provided as a convenience and for informational purposes only. Inclusion of these hyperlinks does not constitute an endorsement or an approval by Vishay of any of the products, services or opinions of the corporation, organization or individual associated with the third-party website. Vishay disclaims any and all liability and bears no responsibility for the accuracy, legality or content of the third-party website or for that of subsequent links.

Except as expressly indicated in writing, Vishay products are not designed for use in medical, life-saving, or life-sustaining applications or for any other application in which the failure of the Vishay product could result in personal injury or death. Customers using or selling Vishay products not expressly indicated for use in such applications do so at their own risk. Please contact authorized Vishay personnel to obtain written terms and conditions regarding products designed for such applications.

No license, express or implied, by estoppel or otherwise, to any intellectual property rights is granted by this document or by any conduct of Vishay. Product names and markings noted herein may be trademarks of their respective owners.