

## Dual INT-A-PAK Low Profile “Half Bridge” (Standard Speed IGBT), 400 A

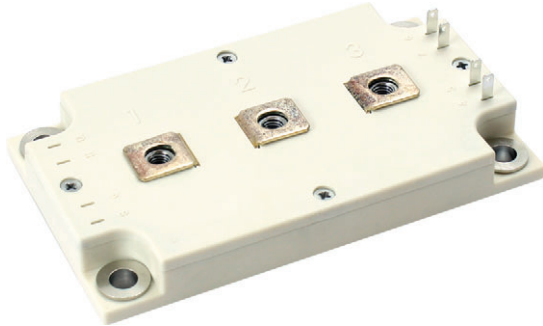

Dual INT-A-PAK Low Profile

### FEATURES

- TrenchStop IGBT technology
- Standard: optimized for hard switching speed
- Low  $V_{CE(on)}$
- Square RBSOA
- Gen 4 FRED Pt<sup>®</sup> dices technology
- Industry standard package
- Al<sub>2</sub>O<sub>3</sub> DBC
- UL approved file E78996
- Designed for industrial level
- Material categorization: for definitions of compliance please see [www.vishay.com/doc?99912](http://www.vishay.com/doc?99912)

**RoHS**  
COMPLIANT

PRIMARY CHARACTERISTICS	
$V_{CES}$	600 V
$I_C$ DC at $T_C = 114\text{ °C}$	400 A
$V_{CE(on)}$ (typical) at 400 A, 25 °C	1.14 V
Speed	DC to 1 kHz
Package	Dual INT-A-PAK low profile
Circuit configuration	Half bridge

### BENEFITS

- Increased operating efficiency
- Performance optimized as output inverter stage for TIG welding machines
- Direct mounting on heatsink
- Very low junction to case thermal resistance

ABSOLUTE MAXIMUM RATINGS				
PARAMETER	SYMBOL	TEST CONDITIONS	MAX.	UNITS
Collector to emitter voltage	$V_{CES}$		600	V
Continuous collector current	$I_C$ <sup>(1)</sup>	$T_C = 25\text{ °C}$	711	A
		$T_C = 80\text{ °C}$	532	
Pulsed collector current	$I_{CM}$	$T_C = 175\text{ °C}$ , $t_p = 6\text{ ms}$ , $V_{GE} = 15\text{ V}$	1100	
Clamped inductive load current	$I_{LM}$		900	
Diode continuous forward current	$I_F$	$T_C = 25\text{ °C}$	260	
		$T_C = 80\text{ °C}$	192	
Gate to emitter voltage	$V_{GE}$		± 20	V
Maximum power dissipation (IGBT)	$P_D$	$T_C = 25\text{ °C}$	1364	W
		$T_C = 80\text{ °C}$	864	
Maximum power dissipation (Diode)	$P_D$	$T_C = 25\text{ °C}$	441	W
		$T_C = 80\text{ °C}$	279	
RMS isolation voltage	$V_{ISOL}$	Any terminal to case ( $V_{RMS}$ $t = 1\text{ s}$ , $T_J = 25\text{ °C}$ )	3500	V

#### Note

<sup>(1)</sup> Maximum continuous collector current must be limited to 500 A to do not exceed the maximum temperature of terminals



<b>ELECTRICAL SPECIFICATIONS</b> ( $T_J = 25\text{ }^\circ\text{C}$ unless otherwise specified)						
PARAMETER	SYMBOL	TEST CONDITIONS	MIN.	TYP.	MAX.	UNITS
Collector to emitter breakdown voltage	$V_{BR(CES)}$	$V_{GE} = 0\text{ V}, I_C = 1.2\text{ mA}$	600	-	-	V
Collector to emitter voltage	$V_{CE(on)}$	$V_{GE} = 15\text{ V}, I_C = 400\text{ A}$	-	1.14	1.40	
		$V_{GE} = 15\text{ V}, I_C = 400\text{ A}, T_J = 125\text{ }^\circ\text{C}$	-	1.13	-	
Gate threshold voltage	$V_{GE(th)}$	$V_{CE} = V_{GE}, I_C = 6\text{ mA}$	3.8	4.7	6.3	mA
Collector to emitter leakage current	$I_{CES}$	$V_{GE} = 0\text{ V}, V_{CE} = 600\text{ V}$ $V_{GE} = 0\text{ V}, V_{CE} = 600\text{ V}, T_J = 125\text{ }^\circ\text{C}$	-	0.002	0.3	
Diode forward voltage drop	$V_{FM}$	$I_{FM} = 400\text{ A}$	-	1.65	2.26	V
		$I_{FM} = 400\text{ A}, T_J = 125\text{ }^\circ\text{C}$	-	1.58	-	
Gate to emitter leakage current	$I_{GES}$	$V_{GE} = \pm 20\text{ V}$	-	-	$\pm 200$	nA

<b>SWITCHING CHARACTERISTICS</b> ( $T_J = 25\text{ }^\circ\text{C}$ unless otherwise specified)						
PARAMETER	SYMBOL	TEST CONDITIONS	MIN.	TYP.	MAX.	UNITS
Total gate charge (turn-on)	$Q_g$	$I_C = 75\text{ A}, V_{CC} = 520\text{ V}, V_{GE} = 15\text{ V}$	-	2791	-	nC
Gate-to-emitter charge (turn-on)	$Q_{ge}$		-	428	-	
Gate-to-collector charge (turn-on)	$Q_{gc}$		-	711	-	
Turn-on switching loss	$E_{on}$	$I_C = 400\text{ A}, V_{CC} = 300\text{ V}, V_{GE} = 15\text{ V}, R_g = 1.5\text{ }\Omega, L = 500\text{ }\mu\text{H}, T_J = 25\text{ }^\circ\text{C}$	-	2.5	-	mJ
Turn-off switching loss	$E_{off}$		-	20.7	-	
Total switching loss	$E_{tot}$		-	23.2	-	
Turn-on switching loss	$E_{on}$		-	2.2	-	
Turn-off switching loss	$E_{off}$		-	27.6	-	
Total switching loss	$E_{tot}$		-	29.8	-	
Turn-on delay time	$t_{d(on)}$	$I_C = 400\text{ A}, V_{CC} = 300\text{ V}, V_{GE} = 15\text{ V}, R_g = 1.5\text{ }\Omega, L = 500\text{ }\mu\text{H}, T_J = 125\text{ }^\circ\text{C}$	-	24	-	ns
Rise time	$t_r$		-	104	-	
Turn-off delay time	$t_{d(off)}$		-	506	-	
Fall time	$t_f$		-	167	-	
Reverse bias safe operating area	RBSOA		$T_J = 175\text{ }^\circ\text{C}, I_C = 900\text{ A}, V_{CC} = 300\text{ V}, V_p = 600\text{ V}, R_g = 27\text{ }\Omega, V_{GE} = 15\text{ V to } -5\text{ V}, L = 500\text{ }\mu\text{H}$	Fullsquare		
Diode reverse recovery time	$t_{rr}$	$I_F = 50\text{ A}, dI_F/dt = 500\text{ A}/\mu\text{s}, V_{CC} = 200\text{ V}, T_J = 25\text{ }^\circ\text{C}$	-	152	-	ns
Diode peak reverse current	$I_{rr}$		-	24	-	A
Diode recovery charge	$Q_{rr}$		-	1.82	-	$\mu\text{C}$
Diode reverse recovery time	$t_{rr}$	$I_F = 50\text{ A}, dI_F/dt = 500\text{ A}/\mu\text{s}, V_{CC} = 200\text{ V}, T_J = 125\text{ }^\circ\text{C}$	-	200	-	ns
Diode peak reverse current	$I_{rr}$		-	39	-	A
Diode recovery charge	$Q_{rr}$		-	3.94	-	$\mu\text{C}$

<b>THERMAL AND MECHANICAL SPECIFICATIONS</b>						
PARAMETER	SYMBOL	MIN.	TYP.	MAX.	UNITS	
Operating junction and storage temperature range	$T_J, T_{Stg}$	-40	-	175	$^\circ\text{C}$	
Junction to case per leg	IGBT	-	-	0.11	$^\circ\text{C}/\text{W}$	
	Diode	-	-	0.34		
Case to sink per module	$R_{thCS}$	-	0.05	-		
Mounting torque	case to heatsink: M6 screw	4	-	6	Nm	
	case to terminal 1, 2, 3: M5 screw	2	-	5		
Weight		-	270	-	g	

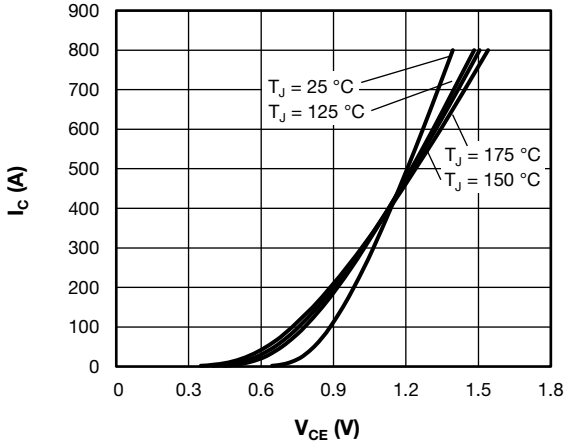

Fig. 1 - Typical Q1 to Q2 IGBT Output Characteristics,  $V_{GE} = 15\text{ V}$

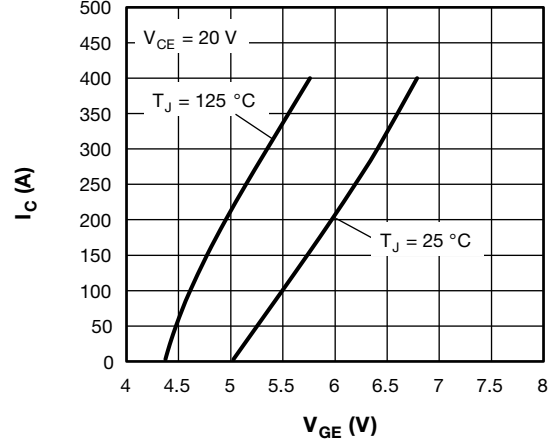

Fig. 4 - Typical Q1 to Q2 IGBT Transfer Characteristics

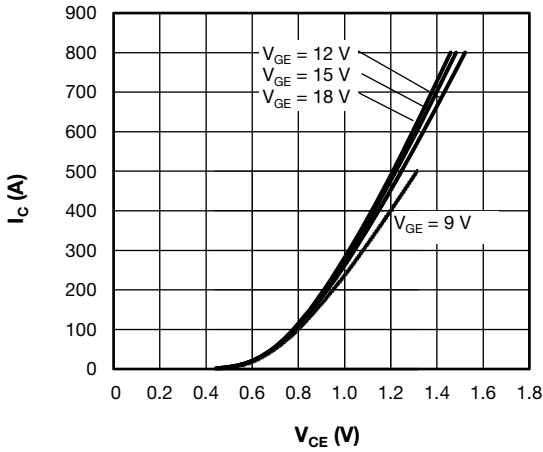

Fig. 2 - Typical Q1 to Q2 IGBT Output Characteristics,  $T_J = 125\text{ °C}$

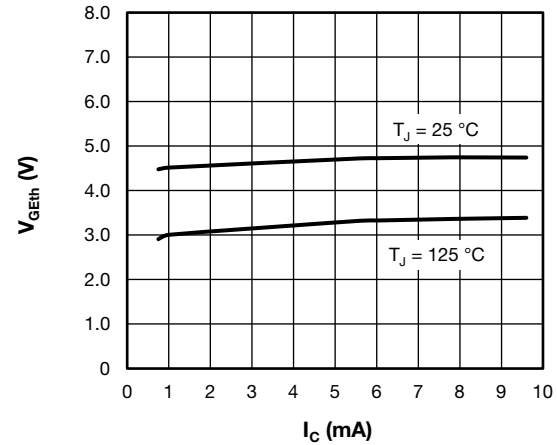

Fig. 5 - Typical Q1 to Q2 IGBT Gate Threshold Voltage

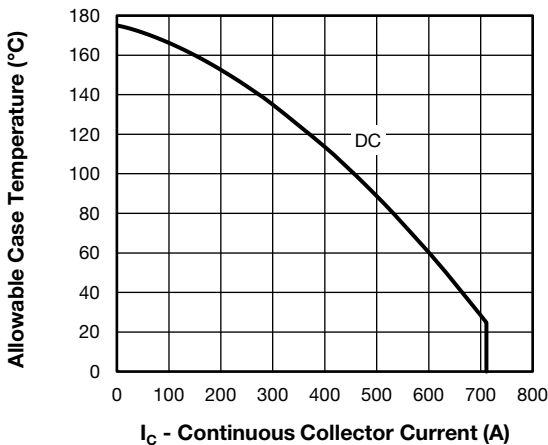

Fig. 3 - Maximum Q1 to Q2 IGBT Continuous Collector Current vs. Case Temperature

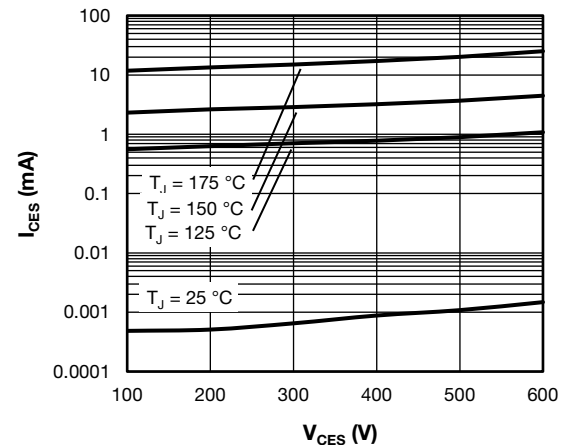

Fig. 6 - Typical Q1 to Q2 IGBT Zero Gate Voltage Collector Current

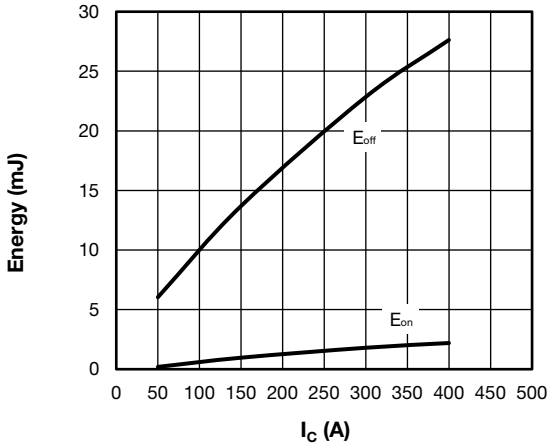

Fig. 7 - Typical Q1 to Q2 IGBT  
Energy Loss vs.  $I_C$  (with D1 to D2 Antiparallel Diode)  
 $T_J = 125^\circ\text{C}$ ,  $V_{CC} = 300\text{ V}$ ,  $R_g = 1.5\ \Omega$ ,  $V_{GE} = +15\text{ V}/-15\text{ V}$ ,  $L = 500\ \mu\text{H}$

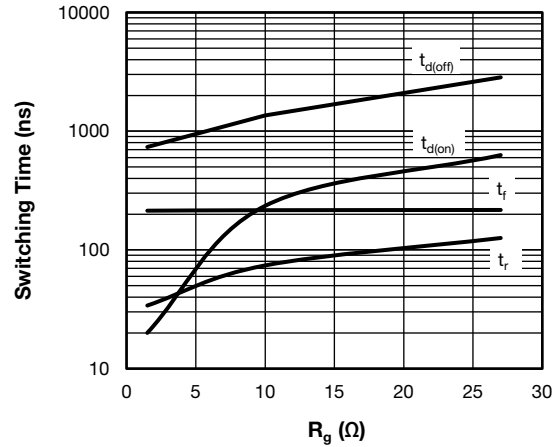

Fig. 10 - Typical Q1 to Q2 IGBT  
Switching Time vs.  $R_g$  (with D1 to D2 Antiparallel Diode)  
 $T_J = 125^\circ\text{C}$ ,  $V_{CC} = 300\text{ V}$ ,  $I_C = 400\text{ A}$ ,  $V_{GE} = +15\text{ V}/-15\text{ V}$ ,  $L = 500\ \mu\text{H}$

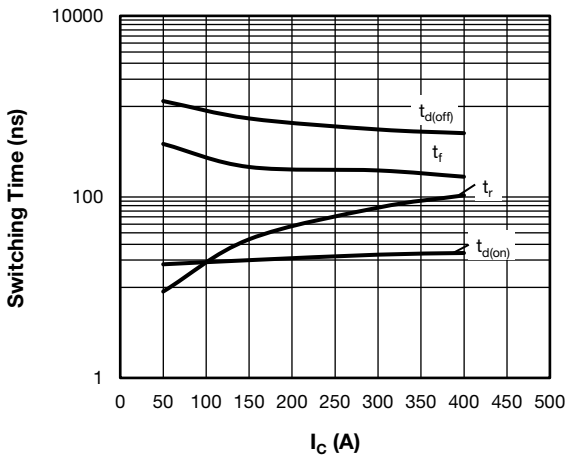

Fig. 8 - Typical Q1 to Q2 IGBT  
Switching Time vs.  $I_C$  (with D1 to D2 Antiparallel Diode)

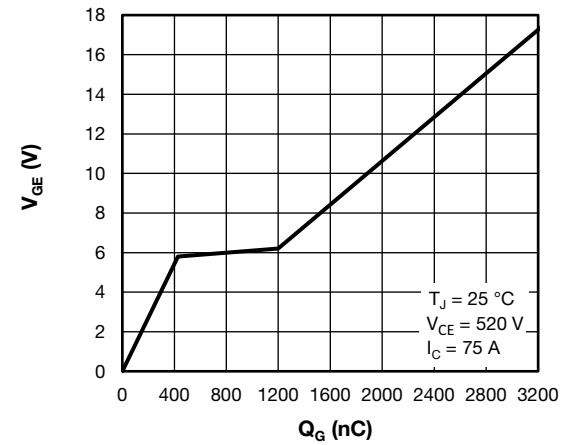

Fig. 11 - Typical Q1 to Q2 IGBT  
Gate Charge vs. Gate to Emitter Voltage  
 $T_J = 25^\circ\text{C}$   
 $V_{CE} = 520\text{ V}$   
 $I_C = 75\text{ A}$

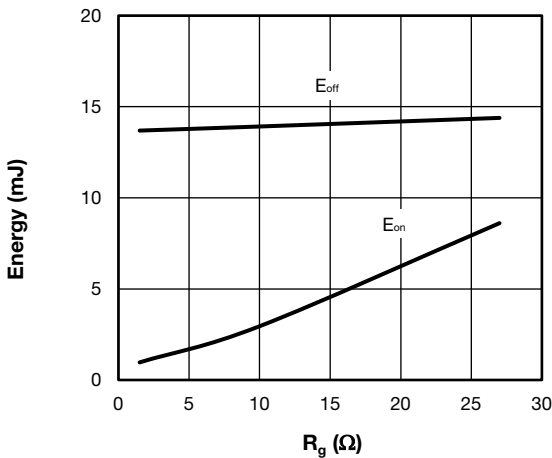

Fig. 9 - Typical Q1 to Q2 IGBT  
Energy Loss vs.  $R_g$  (with D1 to D2 Antiparallel Diode)

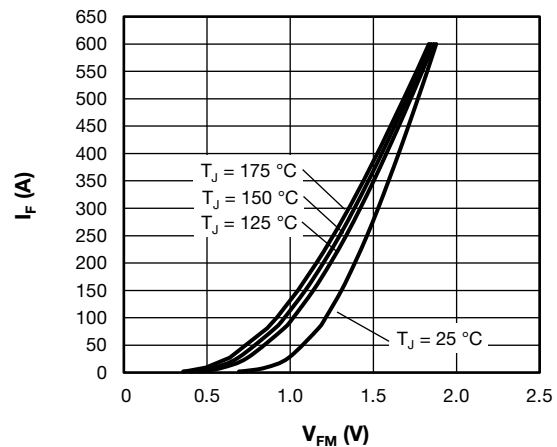

Fig. 12 - Typical D1 to D2 Antiparallel Diode  
Forward Characteristics



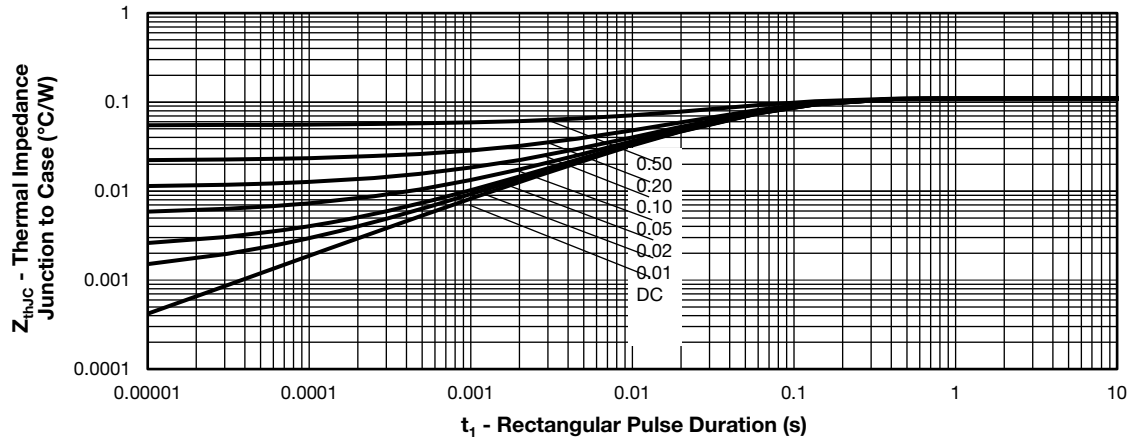

Fig. 19 - Maximum Thermal Impedance  $Z_{thJC}$  Characteristics - (Q1 to Q2 IGBT)

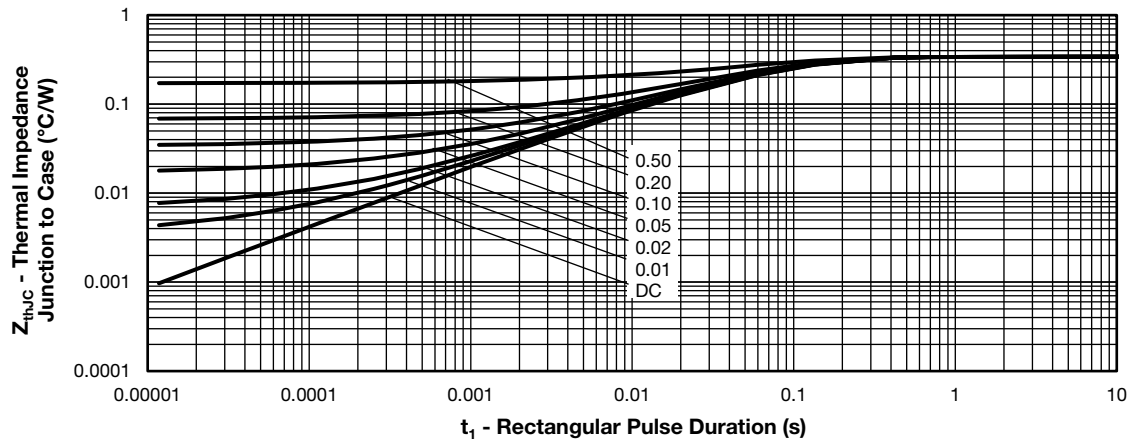

Fig. 20 - Maximum Thermal Impedance  $Z_{thJC}$  Characteristics - (D1 to D2 Antiparallel Diode)

**ORDERING INFORMATION TABLE**

Device code	<b>G</b>	<b>T</b>	<b>400</b>	<b>T</b>	<b>D</b>	<b>60</b>	<b>S</b>
	①	②	③	④	⑤	⑥	⑦
	①	②	③	④	⑤	⑥	⑦
	①	②	③	④	⑤	⑥	⑦
	①	②	③	④	⑤	⑥	⑦
	①	②	③	④	⑤	⑥	⑦
	①	②	③	④	⑤	⑥	⑦
	①	②	③	④	⑤	⑥	⑦

- ① - Insulated gate bipolar transistor (IGBT)
- ② - T = Trench IGBT technology
- ③ - Current rating (400 = 400 A)
- ④ - Circuit configuration (T = half-bridge)
- ⑤ - Package indicator (D = dual INT-A-PAK low profile)
- ⑥ - Voltage rating (60 = 600 V)
- ⑦ - Speed / type (S = standard speed IGBT)



**CIRCUIT CONFIGURATION**

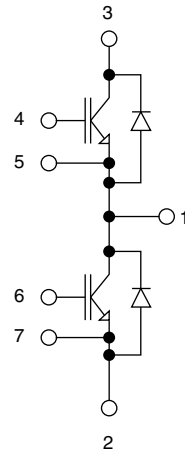

LINKS TO RELATED DOCUMENTS	
Dimensions	<a href="http://www.vishay.com/doc?95435">www.vishay.com/doc?95435</a>



## Dual INT-A-PAK Low Profile

**DIMENSIONS** in millimeters

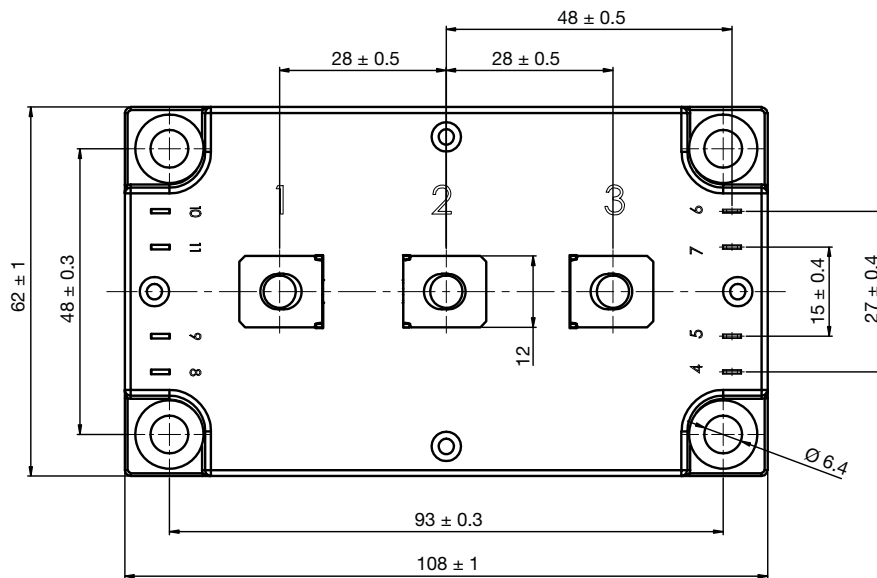
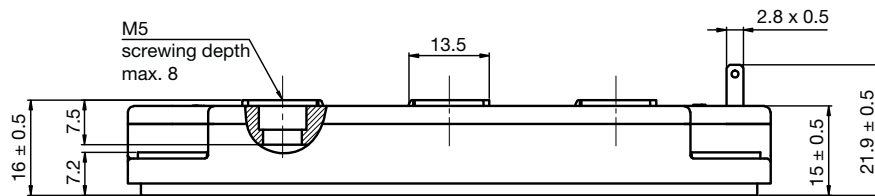





## Disclaimer

ALL PRODUCT, PRODUCT SPECIFICATIONS AND DATA ARE SUBJECT TO CHANGE WITHOUT NOTICE TO IMPROVE RELIABILITY, FUNCTION OR DESIGN OR OTHERWISE.

Vishay Intertechnology, Inc., its affiliates, agents, and employees, and all persons acting on its or their behalf (collectively, "Vishay"), disclaim any and all liability for any errors, inaccuracies or incompleteness contained in any datasheet or in any other disclosure relating to any product.

Vishay makes no warranty, representation or guarantee regarding the suitability of the products for any particular purpose or the continuing production of any product. To the maximum extent permitted by applicable law, Vishay disclaims (i) any and all liability arising out of the application or use of any product, (ii) any and all liability, including without limitation special, consequential or incidental damages, and (iii) any and all implied warranties, including warranties of fitness for particular purpose, non-infringement and merchantability.

Statements regarding the suitability of products for certain types of applications are based on Vishay's knowledge of typical requirements that are often placed on Vishay products in generic applications. Such statements are not binding statements about the suitability of products for a particular application. It is the customer's responsibility to validate that a particular product with the properties described in the product specification is suitable for use in a particular application. Parameters provided in datasheets and / or specifications may vary in different applications and performance may vary over time. All operating parameters, including typical parameters, must be validated for each customer application by the customer's technical experts. Product specifications do not expand or otherwise modify Vishay's terms and conditions of purchase, including but not limited to the warranty expressed therein.

Hyperlinks included in this datasheet may direct users to third-party websites. These links are provided as a convenience and for informational purposes only. Inclusion of these hyperlinks does not constitute an endorsement or an approval by Vishay of any of the products, services or opinions of the corporation, organization or individual associated with the third-party website. Vishay disclaims any and all liability and bears no responsibility for the accuracy, legality or content of the third-party website or for that of subsequent links.

Except as expressly indicated in writing, Vishay products are not designed for use in medical, life-saving, or life-sustaining applications or for any other application in which the failure of the Vishay product could result in personal injury or death. Customers using or selling Vishay products not expressly indicated for use in such applications do so at their own risk. Please contact authorized Vishay personnel to obtain written terms and conditions regarding products designed for such applications.

No license, express or implied, by estoppel or otherwise, to any intellectual property rights is granted by this document or by any conduct of Vishay. Product names and markings noted herein may be trademarks of their respective owners.