

EMIPAK 1B PressFit Power Module 1200 V Silicon Carbide Single Phase Bridge, 30 A



EMIPAK 1B
(package example)

FEATURES

- SiC diode technology
- Exposed Al₂O₃ substrate with low thermal resistance
- Very high frequency operating
- Low internal inductances
- Qualified using AQG324 guideline as reference
- PressFit pins locking technology
PATENT(S): www.vishay.com/patents
- Material categorization: for definitions of compliance please see www.vishay.com/doc?99912



RoHS
COMPLIANT

PRIMARY CHARACTERISTICS

SINGLE PHASE BRIDGE	
V _{RRM}	1200 V
V _{FM} typical at 30 A	1.35 V
I _O at T _{SINK} = 138 °C	30 A
Q _C typical at 30 A	118 nC
Package	EMIPAK 1B
Circuit configuration	SiC diodes full bridge

DESCRIPTION

The EMIPAK 1B package is easy to use thanks to the PressFit pins. The exposed substrate provides improved thermal performance.

The optimized layout also helps to minimize stray parameters, allowing for better EMI performance.

ABSOLUTE MAXIMUM RATINGS (T_J = 25 °C unless otherwise noted)

PARAMETER	SYMBOL	TEST CONDITIONS	MAX.	UNITS
Operating junction temperature	T _J		175	°C
Storage temperature range	T _{Stg}		-40 to +150	
RMS isolation voltage	V _{ISOL}	T _J = 25 °C, all terminals shorted, f = 50 Hz, t = 1 s	3500	V
SINGLE PHASE BRIDGE				
Maximum output current of bridge	I _O	180° conduction angle, T _{SINK} = 25 °C	67	A
		180° conduction angle, T _{SINK} = 80 °C	52	
Maximum peak one cycle forward non-repetitive surge current	I _{FSM}	10 ms sine or 6 ms rectangular pulse, T _J = 25 °C, no voltage reapplied	230	A
		8.3 ms sine, T _J = 25 °C, no voltage reapplied	241	A
Maximum I ² t capability for fusing	I ² t	No voltage reapplied, t = 10 ms	265	A ² s
		No voltage reapplied, t = 8.3 ms	240	
Maximum I ² √t capability for fusing	I ² √t	t = 0.1 ms to 10 ms, no voltage reapplied	2645	A ² √s

ELECTRICAL SPECIFICATIONS (T_J = 25 °C unless otherwise noted)

PARAMETER	SYMBOL	TEST CONDITIONS	MIN.	TYP.	MAX.	UNITS
D1 - D4 SINGLE PHASE BRIDGE						
Forward voltage drop (per diode)	V _{FM}	I _F = 30 A	-	1.35	1.82	V
		I _F = 30 A, T _J = 150 °C	-	1.79	-	
Breakdown voltage (per diode)	V _{BR}	I _R = 1 mA	1200	-	-	V
Reverse leakage current (per diode)	I _{RM}	V _R = 1200 V	-	75	800	μA
		V _R = 1200 V, T _J = 150 °C	-	900	-	

PATENT(S): www.vishay.com/patents

This Vishay product is protected by one or more United States and international patents.



SWITCHING CHARACTERISTICS ($T_J = 25\text{ }^\circ\text{C}$ unless otherwise noted)						
PARAMETER	SYMBOL	TEST CONDITIONS	MIN.	TYP.	MAX.	UNITS
D1 - D4 SINGLE PHASE BRIDGE						
Total capacitive charge (per diode)	Q_C	$V_R = 800\text{ V}$, $di/dt = 500\text{ A}/\mu\text{s}$	-	118	-	nC
Total capacitance (per diode)	C	$V_R = 1\text{ V}$, $f = 1\text{ MHz}$	-	2780	-	pF
		$V_R = 800\text{ V}$, $f = 1\text{ MHz}$	-	253	-	

INTERNAL NTC - THERMISTOR SPECIFICATIONS				
PARAMETER	SYMBOL	TEST CONDITIONS	VALUE	UNITS
Resistance	R_{25}	$T_C = 25\text{ }^\circ\text{C}$	5000	Ω
	R_{100}	$T_C = 100\text{ }^\circ\text{C}$	$493 \pm 5\%$	
B-value	$B_{25/50}$	$R_2 = R_{25} \exp. [B_{25/50} (1/T_2 - 1/298.15K)]$	$3375 \pm 5\%$	K
Maximum operating temperature			220	$^\circ\text{C}$
Dissipation constant			2	mW/ $^\circ\text{C}$
Thermal time constant			8	s

THERMAL AND MECHANICAL SPECIFICATIONS					
PARAMETER	SYMBOL	MIN.	TYP.	MAX.	UNITS
SINGLE PHASE BRIDGE - Thermal resistance junction to sink (per diode) ⁽¹⁾	R_{thJS}	-	0.90	-	$^\circ\text{C}/\text{W}$
Case to sink thermal resistance (per module) ⁽¹⁾		-	0.1	-	
Mounting torque (M4)		2	-	3	Nm
Weight		-	28	-	g

Note

⁽¹⁾ Mounting surface flat, smooth, and greased, $\lambda_{grease} = 0.67\text{ W}/\text{mK}$

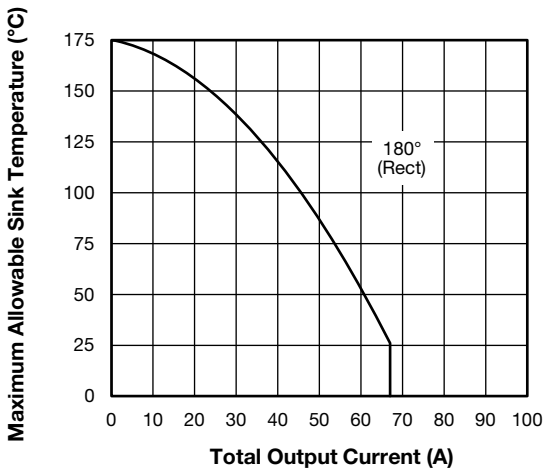

Fig. 1 - Current Rating Characteristics

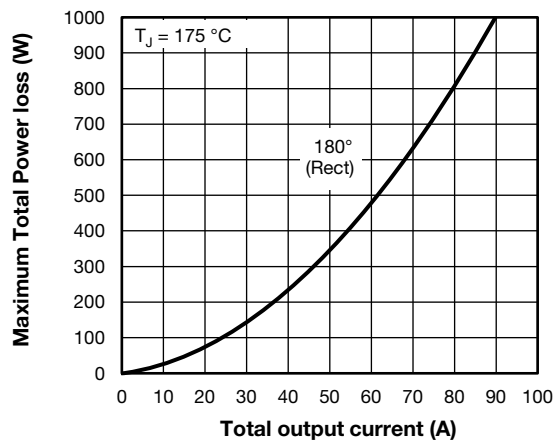

Fig. 2 - Total Power Loss Characteristics

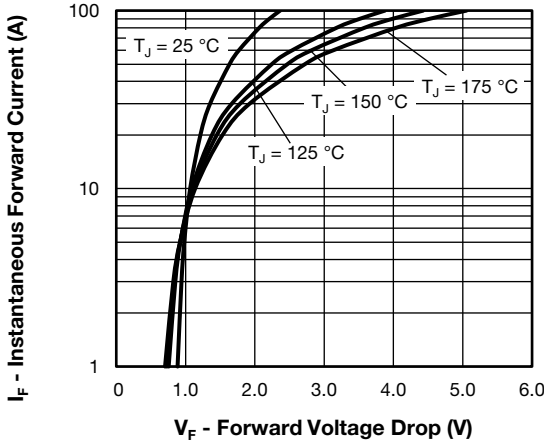

Fig. 3 - Typical Forward Voltage Drop vs. Instantaneous Forward Current (Per Diode)

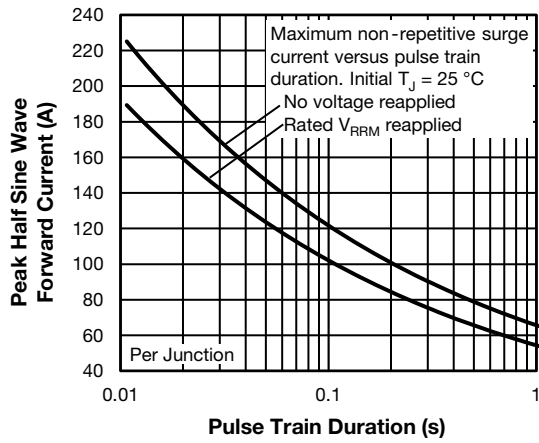

Fig. 6 - Maximum Non-Repetitive Surge Current (2)

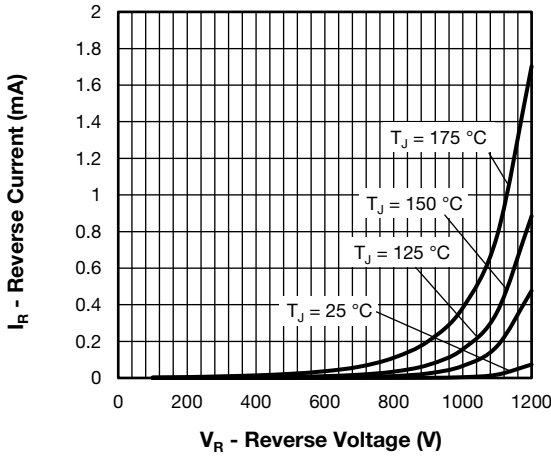

Fig. 4 - Typical Reverse Current vs. Reverse Voltage (Per Diode)

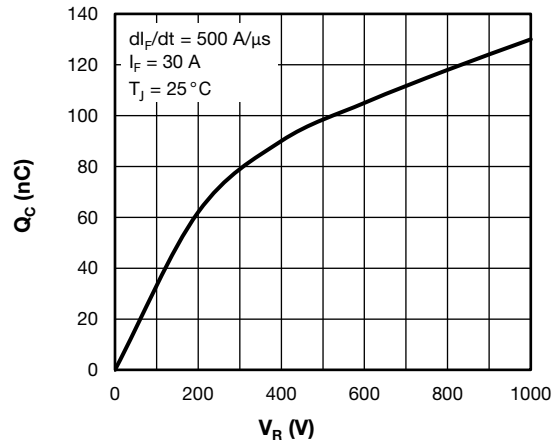

Fig. 7 - Total Capacitance Charge vs. Reverse Voltage (Per Diode)

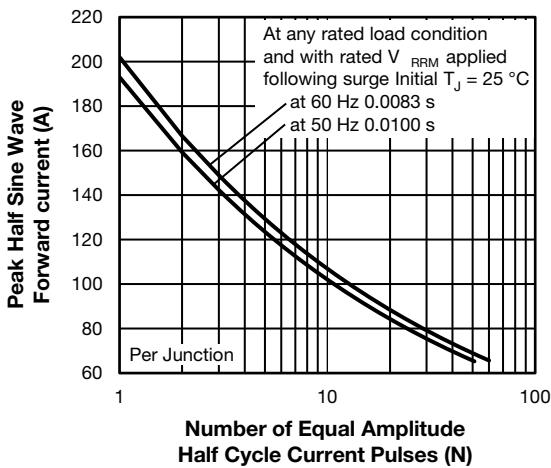

Fig. 5 - Maximum Non-Repetitive Surge Current (1)

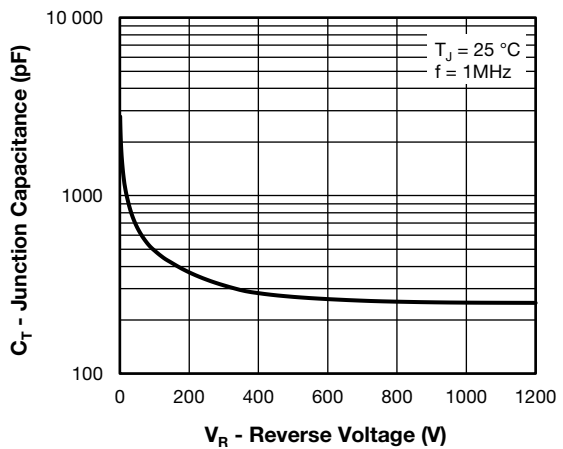

Fig. 8 - Typical Junction Capacitance vs. Reverse Voltage (Per Diode)

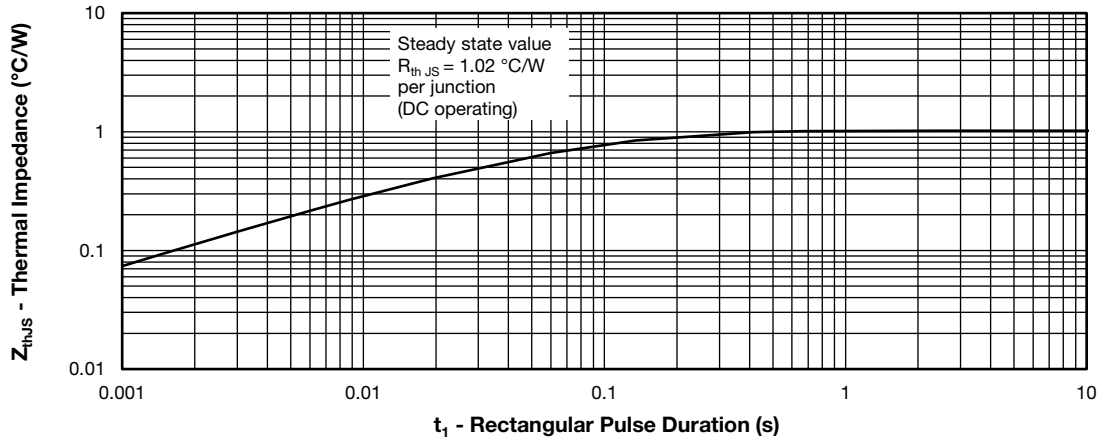

Fig. 9 - Z_{thJS} Thermal Impedance Characteristic (Per Diode)

ORDERING INFORMATION TABLE

Device code	VS-	EN	W	30	S	120	T
	①	②	③	④	⑤	⑥	⑦

- 1** - Vishay Semiconductors product
- 2** - Package indicator (EN = EMIPAK 1B)
- 3** - Circuit configuration (W = SiC diodes full bridge)
- 4** - Current rating (30 = 30 A)
- 5** - Die technology (S = SiC diode)
- 6** - Voltage rating (120 = 1200 V)
- 7** - T = thermistor

CIRCUIT CONFIGURATION

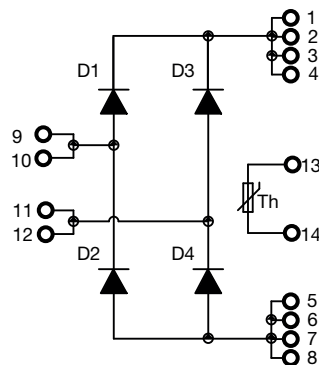



PACKAGE

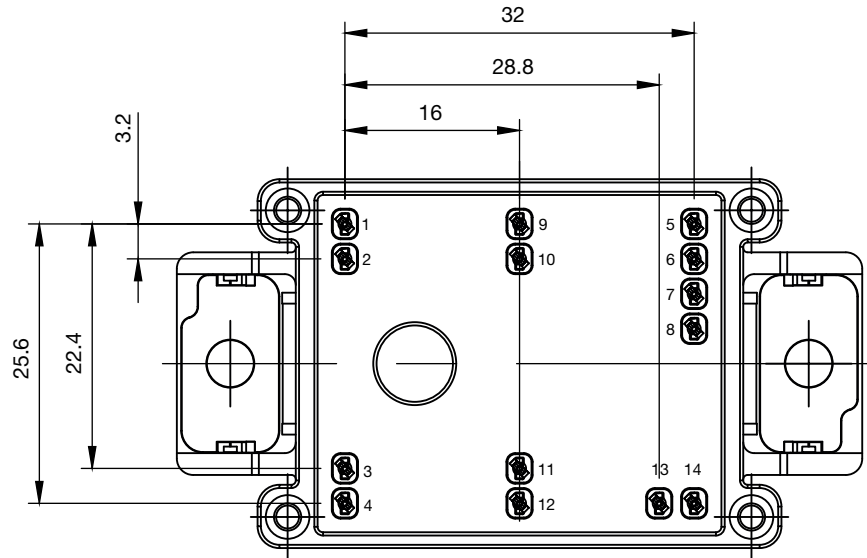

LINKS TO RELATED DOCUMENTS	
Dimensions	www.vishay.com/doc?95558
Application Note	www.vishay.com/doc?95580



Disclaimer

ALL PRODUCT, PRODUCT SPECIFICATIONS AND DATA ARE SUBJECT TO CHANGE WITHOUT NOTICE TO IMPROVE RELIABILITY, FUNCTION OR DESIGN OR OTHERWISE.

Vishay Intertechnology, Inc., its affiliates, agents, and employees, and all persons acting on its or their behalf (collectively, "Vishay"), disclaim any and all liability for any errors, inaccuracies or incompleteness contained in any datasheet or in any other disclosure relating to any product.

Vishay makes no warranty, representation or guarantee regarding the suitability of the products for any particular purpose or the continuing production of any product. To the maximum extent permitted by applicable law, Vishay disclaims (i) any and all liability arising out of the application or use of any product, (ii) any and all liability, including without limitation special, consequential or incidental damages, and (iii) any and all implied warranties, including warranties of fitness for particular purpose, non-infringement and merchantability.

Statements regarding the suitability of products for certain types of applications are based on Vishay's knowledge of typical requirements that are often placed on Vishay products in generic applications. Such statements are not binding statements about the suitability of products for a particular application. It is the customer's responsibility to validate that a particular product with the properties described in the product specification is suitable for use in a particular application. Parameters provided in datasheets and / or specifications may vary in different applications and performance may vary over time. All operating parameters, including typical parameters, must be validated for each customer application by the customer's technical experts. Product specifications do not expand or otherwise modify Vishay's terms and conditions of purchase, including but not limited to the warranty expressed therein.

Hyperlinks included in this datasheet may direct users to third-party websites. These links are provided as a convenience and for informational purposes only. Inclusion of these hyperlinks does not constitute an endorsement or an approval by Vishay of any of the products, services or opinions of the corporation, organization or individual associated with the third-party website. Vishay disclaims any and all liability and bears no responsibility for the accuracy, legality or content of the third-party website or for that of subsequent links.

Except as expressly indicated in writing, Vishay products are not designed for use in medical, life-saving, or life-sustaining applications or for any other application in which the failure of the Vishay product could result in personal injury or death. Customers using or selling Vishay products not expressly indicated for use in such applications do so at their own risk. Please contact authorized Vishay personnel to obtain written terms and conditions regarding products designed for such applications.

No license, express or implied, by estoppel or otherwise, to any intellectual property rights is granted by this document or by any conduct of Vishay. Product names and markings noted herein may be trademarks of their respective owners.