

## Thyristor High Voltage, Phase Control SCR, 50 A

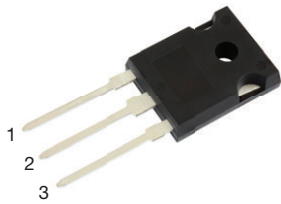

TO-247AD 3L

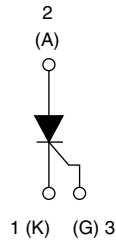

### FEATURES

- AEC-Q101 qualified, meets JESD 201 class 1A whisker test
- Flexible solution for reliable AC power rectification
- Easy control peak current at charger power up to reduce passive / electromechanical components
- Material categorization: for definitions of compliance please see [www.vishay.com/doc?99912](http://www.vishay.com/doc?99912)



**RoHS**  
COMPLIANT  
HALOGEN  
**FREE**

### APPLICATIONS

- On-board and off-board EV / HEV battery chargers
- Renewable energy inverters

### DESCRIPTION

The VS-50TPS12 high voltage series of silicon controlled rectifiers are specifically designed for medium power switching, and phase control applications.

PRIMARY CHARACTERISTICS	
$I_{T(AV)}$	50 A
$V_{DRM}/V_{RRM}$	1200 V
$V_{TM}$ (typ.)	1.2 V
$I_{GT}$ (typ.)	45 mA
$T_J$ max.	150 °C
Package	TO-247AD 3L
Circuit configuration	Single SCR

MAJOR RATINGS AND CHARACTERISTICS				
PARAMETER	SYMBOL	TEST CONDITIONS	VALUES	UNITS
Peak repetitive reverse voltage	$V_{RRM} / V_{DRM}$		1200	V
On-state voltage	$V_T$	50 A, $T_J = 125$ °C	1.2	
Average rectified forward current	$I_{T(AV)}$		50	A
Maximum continuous RMS on-state current	$I_{RMS}$		79	
Non-repetitive peak surge current	$I_{TSM}$		630	
Maximum rate of rise	$dv/dt$		1000	V/ $\mu$ s
Operating junction and storage temperature range	$T_J, T_{Stg}$		-40 to +150	°C

VOLTAGE RATINGS			
PART NUMBER	$V_{RRM} / V_{DRM}$ , MAXIMUM REPETITIVE PEAK AND OFF-STATE VOLTAGE V	$V_{RSM}$ , MAXIMUM NON-REPETITIVE PEAK REVERSE VOLTAGE V	$I_{RRM} / I_{DRM}$ AT 150 °C mA
VS-50TPS12LHM3	1200	1300	70



ABSOLUTE MAXIMUM RATINGS						
PARAMETER	SYMBOL	TEST CONDITIONS		TYP.	MAX.	UNITS
Maximum average on-state current	$I_{T(AV)}$	$T_C = 112\text{ }^\circ\text{C}$ , 180° conduction half sine wave		-	50	A
Maximum continuous RMS on-state current as AC switch	$I_{T(RMS)}$			-	79	
Peak, one-cycle non-repetitive surge current	$I_{TSM}$	10 ms sine pulse, rated $V_{RRM}$ applied	Initial $T_J = T_J$ maximum	-	530	
		10 ms sine pulse, no voltage reapplied		-	630	
$I^2t$ for fusing	$I^2t$	10 ms sine pulse, rated $V_{RRM}$ applied		-	1405	A <sup>2</sup> s
		10 ms sine pulse, no voltage reapplied		-	1986	
$I^2\sqrt{t}$ for fusing	$I^2\sqrt{t}$	$t = 0.1\text{ ms to }10\text{ ms}$ , no voltage reapplied, $T_J = 125\text{ }^\circ\text{C}$		-	19 850	A <sup>2</sup> √s
Low level value of threshold voltage	$V_{T(TO)1}$	$T_J = 125\text{ }^\circ\text{C}$		-	0.89	V
High level value of threshold voltage	$V_{T(TO)2}$			-	0.97	
Low level value of on-state slope resistance	$r_{t1}$			-	6.77	mΩ
High level value of on-state slope resistance	$r_{t2}$			-	6.32	
On-state voltage	$V_T$	50 A, $T_J = 25\text{ }^\circ\text{C}$		1.2	1.32	V
		100 A, $T_J = 25\text{ }^\circ\text{C}$		1.4	1.6	
Rate of rise of turned-on current	$di/dt$	$T_J = 25\text{ }^\circ\text{C}$		-	150	A/μs
Holding current	$I_H$	Anode supply = 6 V, resistive load, $T_J = 25\text{ }^\circ\text{C}$		-	300	mA
Latching current	$I_L$			-	350	
Reverse and direct leakage current	$I_{RRM}/I_{DRM}$	$T_J = 25\text{ }^\circ\text{C}$		-	0.05	
		$T_J = 150\text{ }^\circ\text{C}$		-	70	
Rate of rise of off-state voltage	$dv/dt$	$T_J = T_J$ maximum, linear to 80 % $V_{DRM}$ , $R_g\text{-k} = 100\text{ }^\circ\Omega$		-	1000	V/μs

TRIGGERING						
PARAMETER	SYMBOL	TEST CONDITIONS		TYP.	MAX.	UNITS
Peak gate power	$P_{GM}$	10 ms sine pulse, no voltage reapplied		-	10	W
Average gate power	$P_{G(AV)}$			-	2.5	
Peak gate current	$I_{GM}$			-	2.5	A
Peak negative gate voltage	$-V_{GM}$			-	10	V
Required DC gate voltage to trigger	$V_{GT}$	$T_J = -40\text{ }^\circ\text{C}$	Anode supply = 6 V resistive load	-	1.6	
		$T_J = 25\text{ }^\circ\text{C}$		-	1.5	
		$T_J = 150\text{ }^\circ\text{C}$		-	1	
Required DC gate to trigger	$I_{GT}$	$T_J = -40\text{ }^\circ\text{C}$	Anode supply = 6 V resistive load	-	160	mA
		$T_J = 25\text{ }^\circ\text{C}$		45	100	
		$T_J = 150\text{ }^\circ\text{C}$		-	60	
DC gate voltage not to trigger	$V_{GD}$	$T_J = 150\text{ }^\circ\text{C}$ , $V_{DRM} = \text{rated value}$		-	0.2	V
DC gate current not to trigger	$I_{GD}$			-	3	mA

SWITCHING						
PARAMETER	SYMBOL	TEST CONDITIONS		TYP.	MAX.	UNITS
Turn-on time	$t_{gt}$	$I_T = 50\text{ A}$ , $V_D = 50\% V_{DRM}$ , $I_{gt} = 300\text{ mA}$ , $T_J = 25\text{ }^\circ\text{C}$		1.5	-	μs
Turn-off time	$t_q$	$I_T = 50\text{ A}$ , $V_D = 80\% V_{DRM}$ , $dV/dt = 20\text{ V}/\mu\text{s}$ , $t_p = 200\text{ }^\mu\text{s}$ , $I_{gt} = 100\text{ mA}$ , $dI/dt = 10\text{ A}/\mu\text{s}$ , $V_R = 100\text{ V}$ , $T_J = 150\text{ }^\circ\text{C}$		92	-	



THERMAL AND MECHANICAL SPECIFICATIONS					
PARAMETER	SYMBOL	TEST CONDITIONS	TYP.	MAX.	UNITS
Maximum junction and storage temperature range	$T_J, T_{Stg}$		-40	150	°C
Maximum thermal resistance, junction to case	$R_{thJC}$		-	0.35	°C/W
Maximum thermal resistance, junction to ambient	$R_{thJA}$		-	40	
Typical thermal resistance, case to heatsink	$R_{thCS}$	Mounting surface, smooth, and greased	0.2	-	
Mounting torque	minimum		6 (5)		kgf · cm (lbf · in)
	maximum		12 (10)		
Marking device		Case style Super TO-247AD 3L	50TPS12LH		

$\Delta R_{thJ-HS}$ CONDUCTION PER JUNCTION											
DEVICE	SINE HALF-WAVE CONDUCTION					RECTANGULAR WAVE CONDUCTION					UNITS
	180°	120°	90°	60°	30°	180°	120°	90°	60°	30°	
VS-50TPS12LHM3	0.143	0.166	0.208	0.299	0.490	0.099	0.168	0.223	0.311	0.494	°C/W

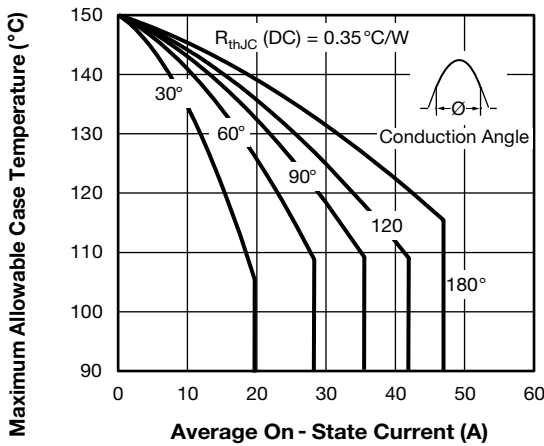

Fig. 1 - Current Rating Characteristics

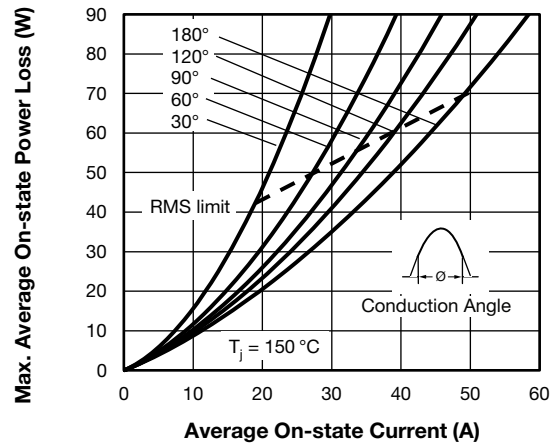

Fig. 3 - On-State Power Loss Characteristics

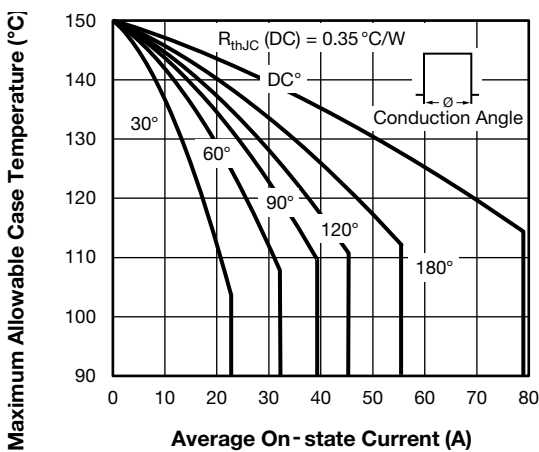

Fig. 2 - Current Rating Characteristics

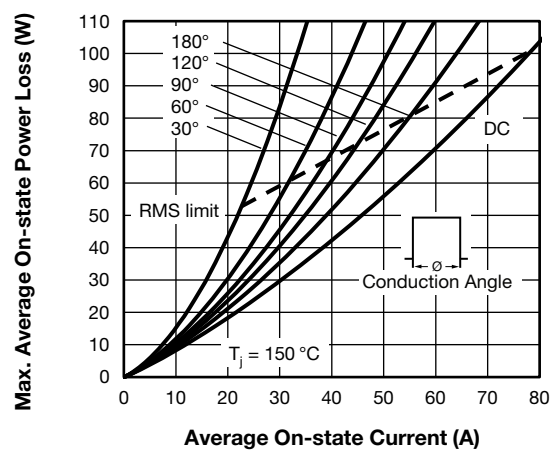

Fig. 4 - On-State Power Loss Characteristics

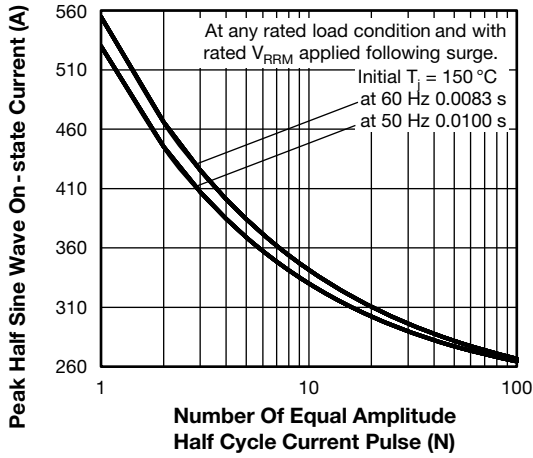

Fig. 5 - Maximum Non-Repetitive Surge Current

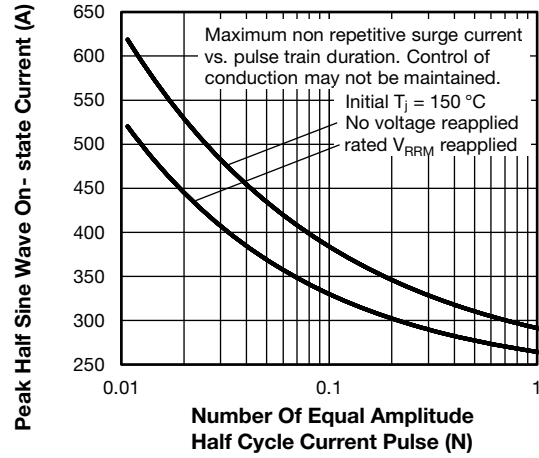

Fig. 6 - Maximum Non-Repetitive Surge Current

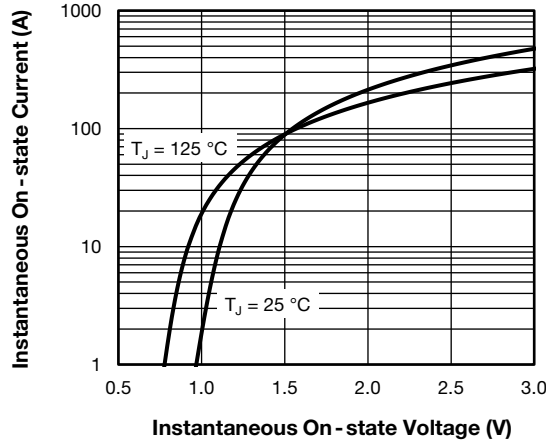

Fig. 7 - On-State Voltage Drop Characteristics

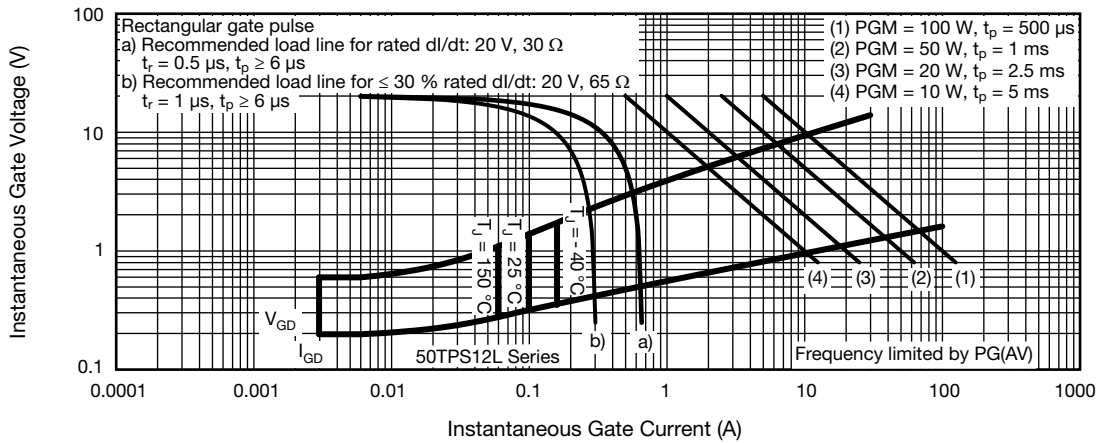

Fig. 8 - Gate Characteristics

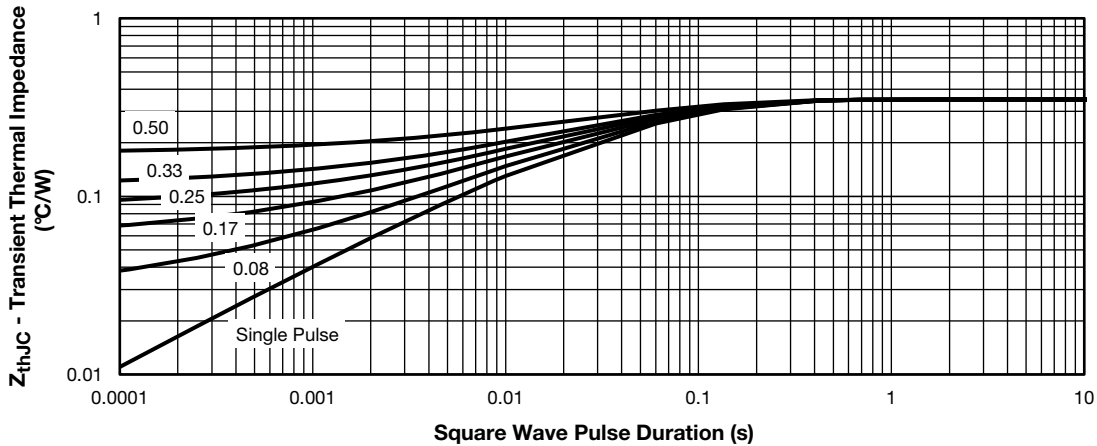

Fig. 9 - Thermal Impedance  $Z_{thJC}$  Characteristics

**ORDERING INFORMATION TABLE**

Device code	<b>VS-</b>	<b>50</b>	<b>T</b>	<b>P</b>	<b>S</b>	<b>12</b>	<b>L</b>	<b>H</b>	<b>M3</b>
	①	②	③	④	⑤	⑥	⑦	⑧	⑨
	<b>1</b>	-	Vishay Semiconductors product						
	<b>2</b>	-	Current code (50 = 50 A)						
	<b>3</b>	-	Circuit configuration: T = thyristor						
	<b>4</b>	-	P = TO-247AD package						
	<b>5</b>	-	Type of silicon: S = standard recovery rectifier						
	<b>6</b>	-	Voltage code (12 = 1200 V)						
	<b>7</b>	-	Package L = long lead						
	<b>8</b>	-	H = AEC-Q101 qualified						
	<b>9</b>	-	M3 = halogen-free, RoHS-compliant, and terminations lead (Pb)-free						

<b>ORDERING INFORMATION</b> (example)			
PREFERRED P/N	QUANTITY PER TUBE	MINIMUM ORDER QUANTITY	PACKAGING DESCRIPTION
VS-50TPS12LHM3	25	contact factory	Antistatic plastic tubes

<b>LINKS TO RELATED DOCUMENTS</b>		
Dimensions	TO-247AD 3L	<a href="http://www.vishay.com/doc?95626">www.vishay.com/doc?95626</a>
Part marking information	TO-247AD 3L	<a href="http://www.vishay.com/doc?95007">www.vishay.com/doc?95007</a>

## TO-247AD 3L

**DIMENSIONS** in millimeters and inches

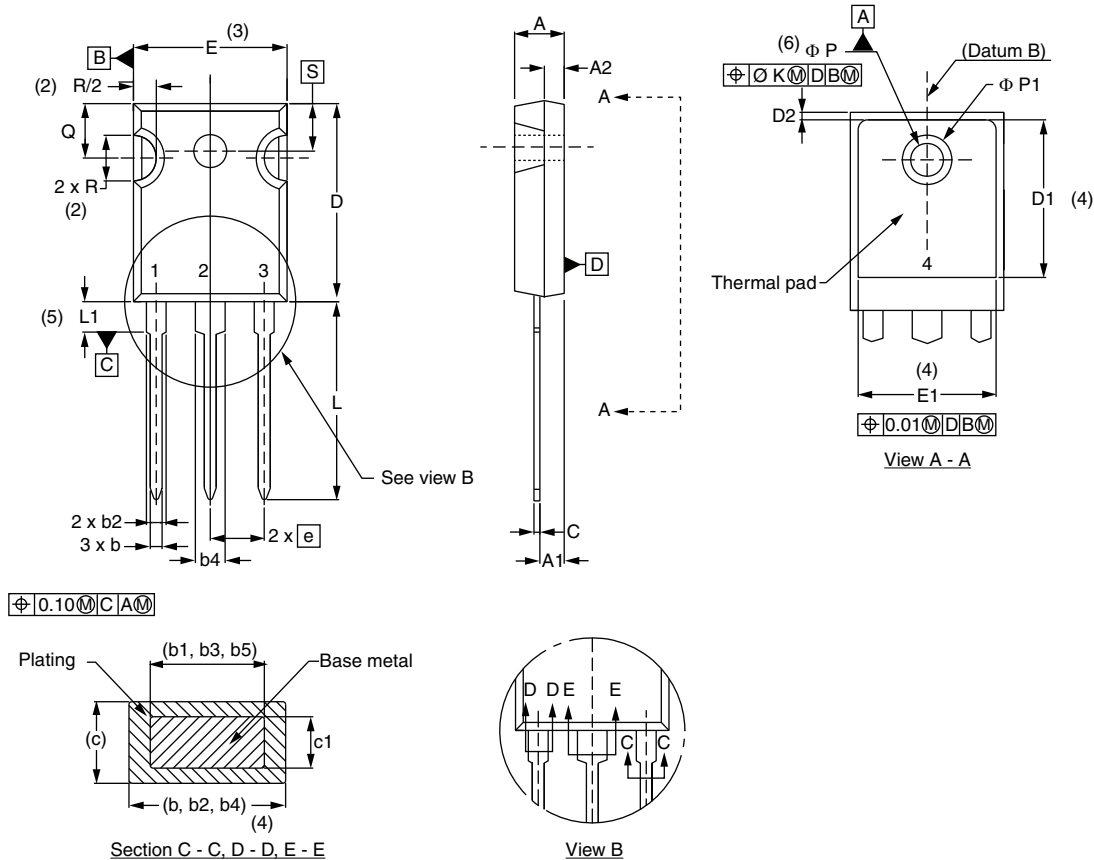

SYMBOL	MILLIMETERS		INCHES		NOTES	SYMBOL	MILLIMETERS		INCHES		NOTES
	MIN.	MAX.	MIN.	MAX.			MIN.	MAX.	MIN.	MAX.	
A	4.65	5.31	0.183	0.209		D2	0.51	1.30	0.020	0.051	
A1	2.21	2.59	0.087	0.102		E	15.29	15.87	0.602	0.625	3
A2	1.50	2.49	0.059	0.098		E1	13.46	-	0.53	-	
b	0.99	1.40	0.039	0.055		e	5.46 BSC		0.215 BSC		
b1	0.99	1.35	0.039	0.053		Ø K	0.254		0.010		
b2	1.65	2.39	0.065	0.094		L	19.81	20.32	0.780	0.800	
b3	1.65	2.34	0.065	0.092		L1	3.71	4.29	0.146	0.169	
b4	2.59	3.43	0.102	0.135		Ø P	3.56	3.66	0.14	0.144	
b5	2.59	3.38	0.102	0.133		Ø P1	-	6.98	-	0.275	
c	0.38	0.89	0.015	0.035		Q	5.31	5.69	0.209	0.224	
c1	0.38	0.84	0.015	0.033		R	4.52	5.49	0.178	0.216	
D	19.71	20.70	0.776	0.815	3	S	5.51 BSC		0.217 BSC		
D1	13.08	-	0.515	-	4						

**Notes**

- (1) Dimensioning and tolerancing per ASME Y14.5M-1994
- (2) Contour of slot optional
- (3) Dimension D and E do not include mold flash. These dimensions are measured at the outermost extremes of the plastic body
- (4) Thermal pad contour optional with dimensions D1 and E1
- (5) Lead finish uncontrolled in L1
- (6) Ø P to have a maximum draft angle of 1.5 to the top of the part with a maximum hole diameter of 3.91 mm (0.154")
- (7) Outline conforms to JEDEC® outline TO-247 with exception of dimension A min., D, E min., Q min., S, and note 4



## Disclaimer

ALL PRODUCT, PRODUCT SPECIFICATIONS AND DATA ARE SUBJECT TO CHANGE WITHOUT NOTICE TO IMPROVE RELIABILITY, FUNCTION OR DESIGN OR OTHERWISE.

Vishay Intertechnology, Inc., its affiliates, agents, and employees, and all persons acting on its or their behalf (collectively, "Vishay"), disclaim any and all liability for any errors, inaccuracies or incompleteness contained in any datasheet or in any other disclosure relating to any product.

Vishay makes no warranty, representation or guarantee regarding the suitability of the products for any particular purpose or the continuing production of any product. To the maximum extent permitted by applicable law, Vishay disclaims (i) any and all liability arising out of the application or use of any product, (ii) any and all liability, including without limitation special, consequential or incidental damages, and (iii) any and all implied warranties, including warranties of fitness for particular purpose, non-infringement and merchantability.

Statements regarding the suitability of products for certain types of applications are based on Vishay's knowledge of typical requirements that are often placed on Vishay products in generic applications. Such statements are not binding statements about the suitability of products for a particular application. It is the customer's responsibility to validate that a particular product with the properties described in the product specification is suitable for use in a particular application. Parameters provided in datasheets and / or specifications may vary in different applications and performance may vary over time. All operating parameters, including typical parameters, must be validated for each customer application by the customer's technical experts. Product specifications do not expand or otherwise modify Vishay's terms and conditions of purchase, including but not limited to the warranty expressed therein.

Hyperlinks included in this datasheet may direct users to third-party websites. These links are provided as a convenience and for informational purposes only. Inclusion of these hyperlinks does not constitute an endorsement or an approval by Vishay of any of the products, services or opinions of the corporation, organization or individual associated with the third-party website. Vishay disclaims any and all liability and bears no responsibility for the accuracy, legality or content of the third-party website or for that of subsequent links.

Except as expressly indicated in writing, Vishay products are not designed for use in medical, life-saving, or life-sustaining applications or for any other application in which the failure of the Vishay product could result in personal injury or death. Customers using or selling Vishay products not expressly indicated for use in such applications do so at their own risk. Please contact authorized Vishay personnel to obtain written terms and conditions regarding products designed for such applications.

No license, express or implied, by estoppel or otherwise, to any intellectual property rights is granted by this document or by any conduct of Vishay. Product names and markings noted herein may be trademarks of their respective owners.