

Thyristor High Voltage, Phase Control SCR, 40 A

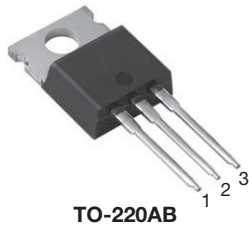

TO-220AB

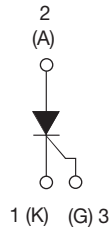

FEATURES

- Easy control peak current at charger power up to reduce passive / electromechanical components
- Flexible solution for reliable AC power rectification
- Meets JESD 201 class 1A whisker test
- AEC-Q101 qualified
- Material categorization: for definitions of compliance please see www.vishay.com/doc?99912



RoHS
COMPLIANT
HALOGEN
FREE

APPLICATIONS

- On-board and off-board EV/HEV battery chargers
- Renewable energy inverters

DESCRIPTION

The VS-40TTS12HM3 high voltage series of silicon controlled rectifiers are specifically designed for medium power switching and phase control applications.

| PRIMARY CHARACTERISTICS | |
|-------------------------|------------------|
| $I_{T(AV)}$ | 25 A |
| V_{DRM}/V_{RRM} | 1200 V |
| V_{TM} | 1.6 V |
| I_{GT} | 35 mA |
| T_J | -40 °C to 140 °C |
| Package | TO-220AB |
| Circuit configuration | Single SCR |

| MAJOR RATINGS AND CHARACTERISTICS | | | |
|-----------------------------------|----------------------|-------------|-------|
| PARAMETER | TEST CONDITIONS | VALUES | UNITS |
| $I_{T(AV)}$ | Sinusoidal waveform | 25 | A |
| I_{RMS} | | 40 | |
| V_{RRM}/V_{DRM} | | 1200 | V |
| I_{TSM} | | 350 | A |
| V_T | $T_J = 25\text{ °C}$ | 1.6 | V |
| dV/dt | | 500 | V/μs |
| dI/dt | | 150 | A/μs |
| T_J | | -40 to +140 | °C |

| VOLTAGE RATINGS | | | |
|-----------------|---|--|-------------|
| PART NUMBER | V_{RRM} , MAXIMUM PEAK REVERSE VOLTAGE V | V_{DRM} , MAXIMUM PEAK DIRECT VOLTAGE V | T_J °C |
| VS-40TTS12HM3 | 1200 | 1200 | -25 to +140 |



| ABSOLUTE MAXIMUM RATINGS | | | | | |
|--|-------------------|--|-----------------------------------|---------------|----|
| PARAMETER | SYMBOL | TEST CONDITIONS | VALUES | UNITS | |
| Maximum average on-state current | $I_{T(AV)}$ | $T_C = 93\text{ }^\circ\text{C}$, 180° conduction half sine wave | 25 | A | |
| Maximum RMS on-state current | I_{RMS} | | 40 | | |
| Maximum peak, one-cycle non-repetitive surge current | I_{TSM} | 10 ms sine pulse, rated V_{RRM} applied | 300 | | |
| | | 10 ms sine pulse, no voltage reapplied | 350 | | |
| Maximum I^2t for fusing | I^2t | 10 ms sine pulse, rated V_{RRM} applied | 450 | A^2s | |
| | | 10 ms sine pulse, no voltage reapplied | 630 | | |
| Maximum $I^2\sqrt{t}$ for fusing | $I^2\sqrt{t}$ | $t = 0.1$ to 10 ms, no voltage reapplied | 6300 | $A^2\sqrt{s}$ | |
| Maximum on-state voltage | V_{TM} | 80 A, $T_J = 25\text{ }^\circ\text{C}$ | 1.6 | V | |
| Low level value of on-state slope resistance | r_t | $T_J = 140\text{ }^\circ\text{C}$ | 11.4 | $m\Omega$ | |
| Low level value of threshold voltage | $V_{T(TO)}$ | | 0.96 | V | |
| Maximum reverse and direct leakage current | I_{RRM}/I_{DRM} | $V_R = \text{Rated } V_{RRM}/V_{DRM}$ | $T_J = 25\text{ }^\circ\text{C}$ | 0.5 | mA |
| | | | $T_J = 140\text{ }^\circ\text{C}$ | 12 | |
| Holding current | I_H | Anode supply = 6 V, resistive load, initial $I_T = 1$ A, $T_J = 25\text{ }^\circ\text{C}$ | 100 | | |
| Maximum latching current | I_L | Anode supply = 6 V, resistive load, $T_J = 25\text{ }^\circ\text{C}$ | 200 | | |
| Maximum rate of rise of off-state voltage | dV/dt | $T_J = T_{J\text{ max.}}$, linear to $80\text{ }^\circ\text{C}$, $V_{DRM} = R_g - k = \text{Open}$ | 500 | $V/\mu s$ | |
| Maximum rate of rise of turned-on current | dI/dt | | 150 | $A/\mu s$ | |

| TRIGGERING | | | | |
|---|-------------|--|--------|-------|
| PARAMETER | SYMBOL | TEST CONDITIONS | VALUES | UNITS |
| Maximum peak gate power | P_{GM} | | 8.0 | W |
| Maximum average gate power | $P_{G(AV)}$ | | 2.0 | |
| Maximum peak positive gate current | + I_{GM} | | 1.5 | A |
| Maximum peak negative gate voltage | - V_{GM} | | 10 | V |
| Maximum required DC gate current to trigger | I_{GT} | Anode supply = 6 V, resistive load, $T_J = 25\text{ }^\circ\text{C}$ | 35 | mA |
| Maximum required DC gate voltage to trigger | V_{GT} | Anode supply = 6 V, resistive load, $T_J = 25\text{ }^\circ\text{C}$ | 1.3 | V |
| Maximum DC gate voltage not to trigger | V_{GD} | $T_J = 140\text{ }^\circ\text{C}$, $V_{DRM} = \text{Rated value}$ | 0.2 | |
| Maximum DC gate current not to trigger | I_{GD} | | 1.5 | mA |

| SWITCHING | | | | |
|-------------------------------|----------|-----------------------------------|--------|---------|
| PARAMETER | SYMBOL | TEST CONDITIONS | VALUES | UNITS |
| Typical turn-on time | t_{gt} | $T_J = 25\text{ }^\circ\text{C}$ | 0.9 | μs |
| Typical reverse recovery time | t_{rr} | $T_J = 140\text{ }^\circ\text{C}$ | 4 | |
| Typical turn-off time | t_q | | 110 | |



| THERMAL AND MECHANICAL SPECIFICATIONS | | | | |
|---|----------------|---------------------------------------|------------|-----------------------------|
| PARAMETER | SYMBOL | TEST CONDITIONS | VALUES | UNITS |
| Maximum junction and storage temperature range | T_J, T_{Stg} | | -40 to 140 | $^{\circ}\text{C}$ |
| Maximum thermal resistance, junction to case | R_{thJC} | DC operation | 0.8 | $^{\circ}\text{C}/\text{W}$ |
| Maximum thermal resistance, junction to ambient | R_{thJA} | | 60 | |
| Typical thermal resistance, case to heatsink | R_{thCS} | Mounting surface, smooth, and greased | 0.5 | |
| Approximate weight | | | 2 | g |
| | | | 0.07 | oz. |
| Mounting torque | minimum | | 6 (5) | kgf · cm (lbf · in) |
| | maximum | | 12 (10) | |
| Marking device | | Case style TO-220AB | 40TTS12H | |

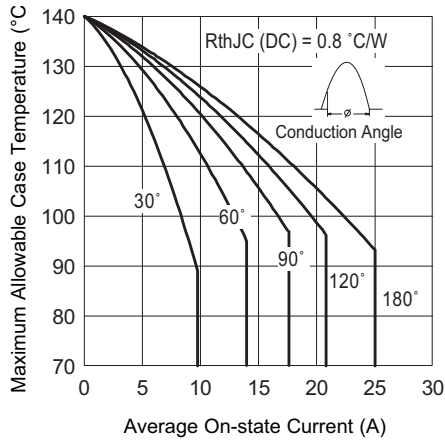

Fig. 1 - Current Rating Characteristics

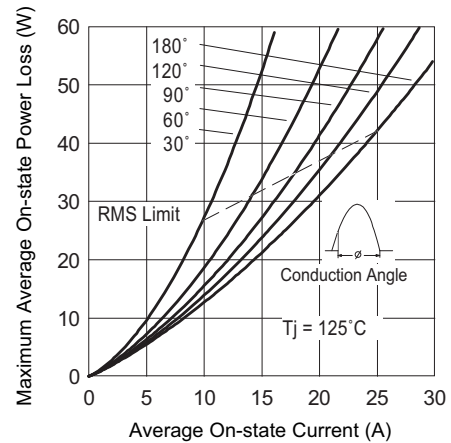

Fig. 3 - On-State Power Loss Characteristics

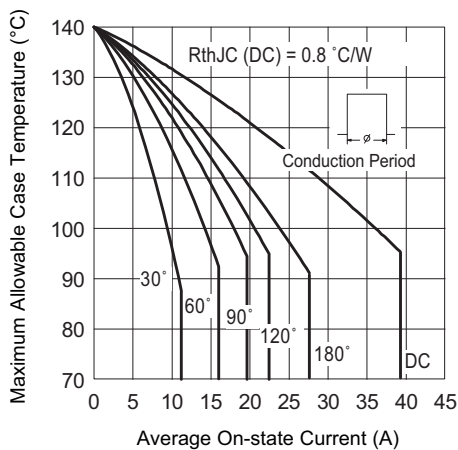

Fig. 2 - Current Rating Characteristics

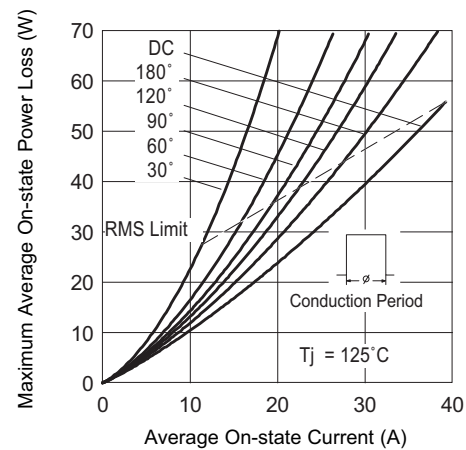

Fig. 4 - On-State Power Loss Characteristics

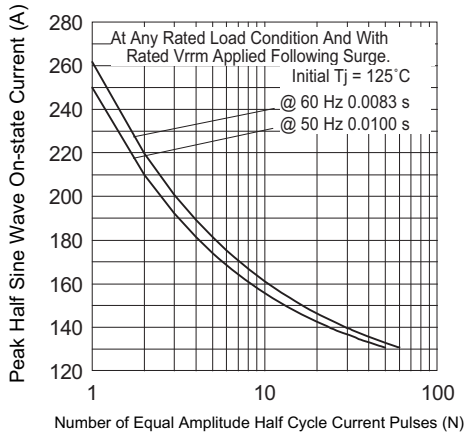

Fig. 5 - Maximum Non-Repetitive Surge Current

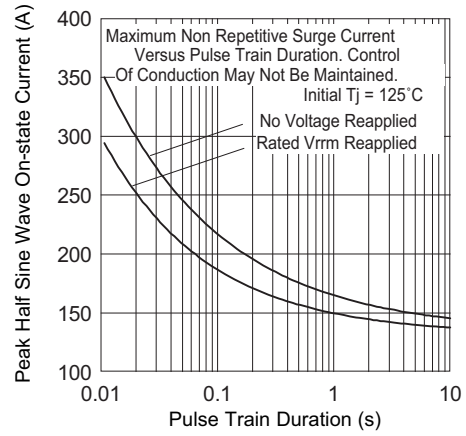

Fig. 6 - Maximum Non-Repetitive Surge Current

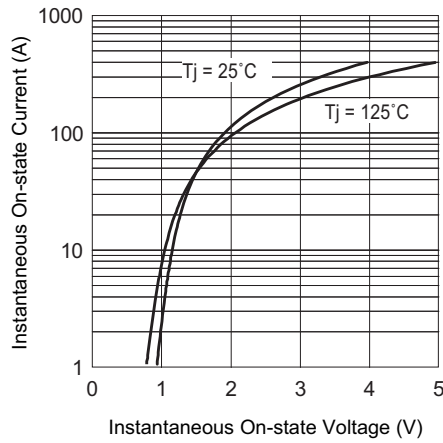

Fig. 7 - On-State Voltage Drop Characteristics

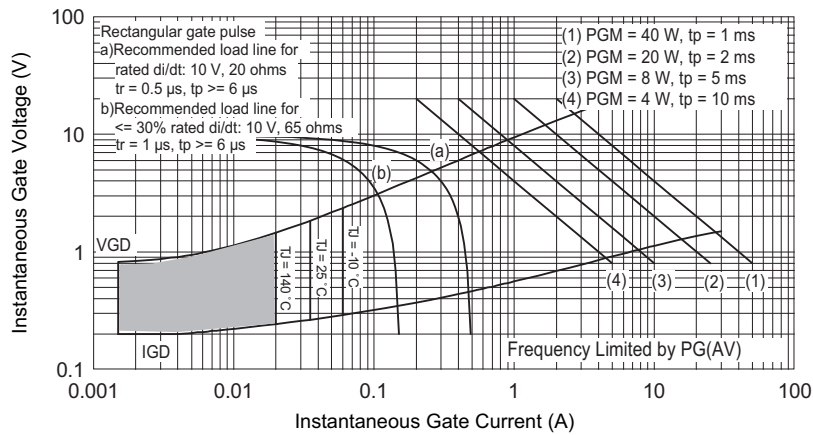

Fig. 8 - Gate Characteristics

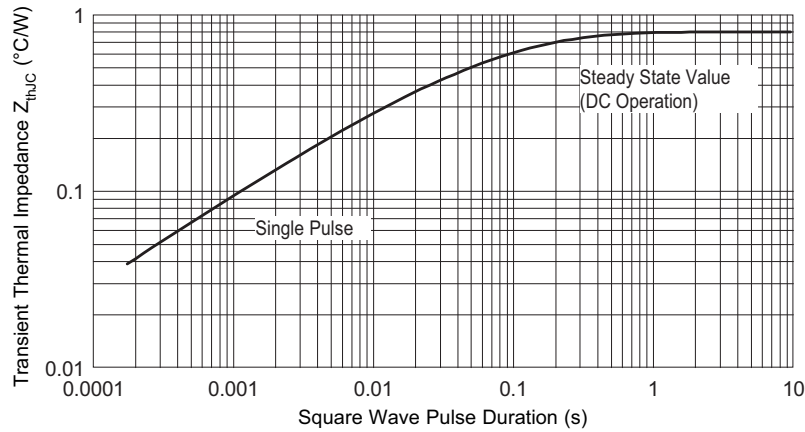

Fig. 9 - Thermal Impedance Z_{thJC} Characteristics

ORDERING INFORMATION TABLE

| | | | | | | | | |
|-------------|------------|-----------|----------|----------|----------|-----------|----------|-----------|
| Device code | VS- | 40 | T | T | S | 12 | H | M3 |
| | ① | ② | ③ | ④ | ⑤ | ⑥ | ⑦ | ⑧ |

- 1** - Vishay Semiconductors product
- 2** - Current rating, RMS value
- 3** - Circuit configuration:
T = single thyristor
- 4** - Package:
T = TO-220
- 5** - Type of silicon:
S = standard recovery rectifier
- 6** - Voltage rating (12 = 1200 V)
- 7** - H = AEC-Q101 qualified
- 8** - Environmental digit:
M3 = halogen-free, RoHS-compliant, and terminations lead (Pb)-free

| ORDERING INFORMATION (Example) | | | |
|---------------------------------------|-------------------|------------------------|--------------------------|
| PREFERRED P/N | QUANTITY PER TUBE | MINIMUM ORDER QUANTITY | PACKAGING DESCRIPTION |
| VS-40TTS12HM3 | 50 | 1000 | Antistatic plastic tubes |

| LINKS TO RELATED DOCUMENTS | |
|-----------------------------------|---|
| Dimensions | www.vishay.com/doc?95222 |
| Part marking information | TO-220AB www.vishay.com/doc?95028 |

TO-220AB

DIMENSIONS in millimeters and inches

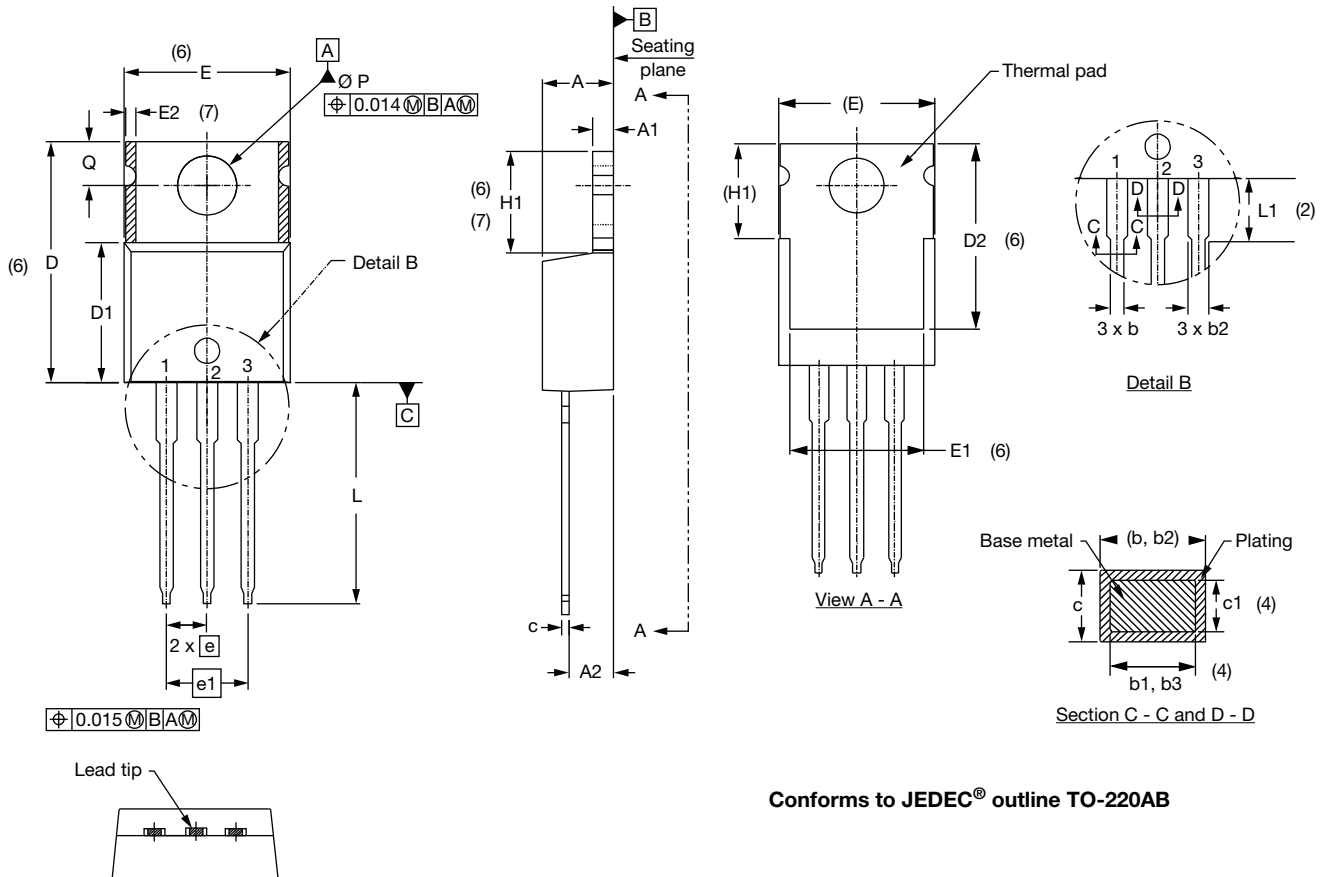

Conforms to JEDEC® outline TO-220AB

| SYMBOL | MILLIMETERS | | INCHES | | NOTES | SYMBOL | MILLIMETERS | | INCHES | | NOTES |
|--------|-------------|-------|--------|-------|-------|--------|-------------|-------|--------|-------|-------|
| | MIN. | MAX. | MIN. | MAX. | | | MIN. | MAX. | MIN. | MAX. | |
| A | 4.25 | 4.65 | 0.167 | 0.183 | | D2 | 11.68 | 12.88 | 0.460 | 0.507 | 6 |
| A1 | 1.14 | 1.40 | 0.045 | 0.055 | | E | 10.11 | 10.51 | 0.398 | 0.414 | 3, 6 |
| A2 | 2.56 | 2.92 | 0.101 | 0.115 | | E1 | 6.86 | 8.89 | 0.270 | 0.350 | 6 |
| b | 0.69 | 1.01 | 0.027 | 0.040 | | E2 | - | 0.76 | - | 0.030 | 7 |
| b1 | 0.38 | 0.97 | 0.015 | 0.038 | 4 | e | 2.41 | 2.67 | 0.095 | 0.105 | |
| b2 | 1.20 | 1.73 | 0.047 | 0.068 | | e1 | 4.88 | 5.28 | 0.192 | 0.208 | |
| b3 | 1.14 | 1.73 | 0.045 | 0.068 | 4 | H1 | 5.84 | 6.86 | 0.230 | 0.270 | 6, 7 |
| c | 0.36 | 0.61 | 0.014 | 0.024 | | L | 13.52 | 14.02 | 0.532 | 0.552 | |
| c1 | 0.36 | 0.56 | 0.014 | 0.022 | 4 | L1 | 3.32 | 3.82 | 0.131 | 0.150 | 2 |
| D | 14.85 | 15.25 | 0.585 | 0.600 | 3 | ∅ P | 3.54 | 3.73 | 0.139 | 0.147 | |
| D1 | 8.38 | 9.02 | 0.330 | 0.355 | | Q | 2.60 | 3.00 | 0.102 | 0.118 | |

Notes

- (1) Dimensioning and tolerancing as per ASME Y14.5M-1994
- (2) Lead dimension and finish uncontrolled in L1
- (3) Dimension D, D1 and E do not include mold flash. Mold flash shall not exceed 0.127 mm (0.005") per side. These dimensions are measured at the outermost extremes of the plastic body
- (4) Dimension b1, b3 and c1 apply to base metal only
- (5) Controlling dimensions: inches
- (6) Thermal pad contour optional within dimensions E, H1, D2 and E1
- (7) Dimensions E2 x H1 define a zone where stamping and singulation irregularities are allowed
- (8) Outline conforms to JEDEC® TO-220, except A2 (maximum) and D2 (minimum) where dimensions are derived from the actual package outline



Disclaimer

ALL PRODUCT, PRODUCT SPECIFICATIONS AND DATA ARE SUBJECT TO CHANGE WITHOUT NOTICE TO IMPROVE RELIABILITY, FUNCTION OR DESIGN OR OTHERWISE.

Vishay Intertechnology, Inc., its affiliates, agents, and employees, and all persons acting on its or their behalf (collectively, "Vishay"), disclaim any and all liability for any errors, inaccuracies or incompleteness contained in any datasheet or in any other disclosure relating to any product.

Vishay makes no warranty, representation or guarantee regarding the suitability of the products for any particular purpose or the continuing production of any product. To the maximum extent permitted by applicable law, Vishay disclaims (i) any and all liability arising out of the application or use of any product, (ii) any and all liability, including without limitation special, consequential or incidental damages, and (iii) any and all implied warranties, including warranties of fitness for particular purpose, non-infringement and merchantability.

Statements regarding the suitability of products for certain types of applications are based on Vishay's knowledge of typical requirements that are often placed on Vishay products in generic applications. Such statements are not binding statements about the suitability of products for a particular application. It is the customer's responsibility to validate that a particular product with the properties described in the product specification is suitable for use in a particular application. Parameters provided in datasheets and / or specifications may vary in different applications and performance may vary over time. All operating parameters, including typical parameters, must be validated for each customer application by the customer's technical experts. Product specifications do not expand or otherwise modify Vishay's terms and conditions of purchase, including but not limited to the warranty expressed therein.

Hyperlinks included in this datasheet may direct users to third-party websites. These links are provided as a convenience and for informational purposes only. Inclusion of these hyperlinks does not constitute an endorsement or an approval by Vishay of any of the products, services or opinions of the corporation, organization or individual associated with the third-party website. Vishay disclaims any and all liability and bears no responsibility for the accuracy, legality or content of the third-party website or for that of subsequent links.

Except as expressly indicated in writing, Vishay products are not designed for use in medical, life-saving, or life-sustaining applications or for any other application in which the failure of the Vishay product could result in personal injury or death. Customers using or selling Vishay products not expressly indicated for use in such applications do so at their own risk. Please contact authorized Vishay personnel to obtain written terms and conditions regarding products designed for such applications.

No license, express or implied, by estoppel or otherwise, to any intellectual property rights is granted by this document or by any conduct of Vishay. Product names and markings noted herein may be trademarks of their respective owners.