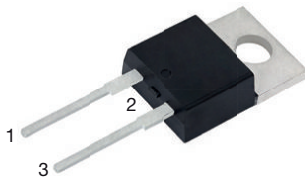
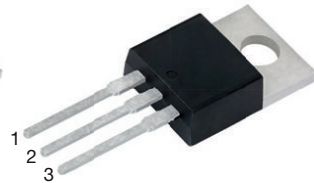
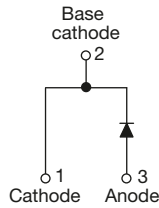
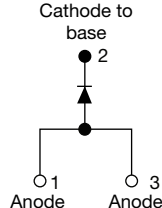

## High Voltage, Input Rectifier Diode, 20 A

**TO-220AC 2L**

**TO-220AB 3L**

**VS-20ETS..**

**VS-20ATS..**

### FEATURES

- Very low forward voltage drop
- 150 °C max. operating junction temperature
- Glass passivated pellet chip junction
- Designed and qualified according to JEDEC®-JESD 47
- Material categorization: for definitions of compliance please see [www.vishay.com/doc?99912](http://www.vishay.com/doc?99912)

**RoHS**  
 COMPLIANT  
 HALOGEN  
**FREE**

### APPLICATIONS

- Input rectification
- Vishay Semiconductors switches and output rectifiers which are available in identical package outlines

### DESCRIPTION

High voltage rectifiers optimized for very low forward voltage drop with moderate leakage.

These devices are intended for use in main rectification (single or three phase bridge).

### PRIMARY CHARACTERISTICS

$I_{F(AV)}$	20 A
$V_R$	800 V, 1200 V
$V_F$ at $I_F$	1.1 V
$I_{FSM}$	300 A
$T_J$ max.	150 °C
Package	TO-220AC 2L, TO-220AB 3L
Circuit configuration	Single, common anode

### OUTPUT CURRENT IN TYPICAL APPLICATIONS

APPLICATIONS	SINGLE-PHASE BRIDGE	THREE-PHASE BRIDGE	UNITS
Capacitive input filter $T_A = 55$ °C, $T_J = 125$ °C common heatsink of 1 °C/W	16.3	21	A

### MAJOR RATINGS AND CHARACTERISTICS

SYMBOL	CHARACTERISTICS	VALUES	UNITS
$I_{F(AV)}$	Sinusoidal waveform	20	A
$V_{RRM}$		800, 1200	V
$I_{FSM}$		300	A
$V_F$	10 A, $T_J = 25$ °C	1.0	V
$T_J$		-40 to +150	°C

### VOLTAGE RATINGS

PART NUMBER	$V_{RRM}$ , MAXIMUM PEAK REVERSE VOLTAGE V	$V_{RSM}$ , MAXIMUM NON-REPETITIVE PEAK REVERSE VOLTAGE V	$I_{RRM}$ AT 150 °C mA
VS-20ETS08-M3, VS-20ATS08-M3	800	900	1
VS-20ETS12-M3, VS-20ATS12-M3	1200	1300	

**ABSOLUTE MAXIMUM RATINGS**

PARAMETER	SYMBOL	TEST CONDITIONS	VALUES	UNITS
Maximum average forward current	$I_{F(AV)}$	$T_C = 105\text{ }^\circ\text{C}$ , 180° conduction half sine wave	20	A
Maximum peak one cycle non-repetitive surge current	$I_{FSM}$	10 ms sine pulse, rated $V_{RRM}$ applied	250	
		10 ms sine pulse, no voltage reapplied	300	
Maximum $I^2t$ for fusing	$I^2t$	10 ms sine pulse, rated $V_{RRM}$ applied	316	$A^2s$
		10 ms sine pulse, no voltage reapplied	442	
Maximum $I^2\sqrt{t}$ for fusing	$I^2\sqrt{t}$	$t = 0.1\text{ ms to }10\text{ ms}$ , no voltage reapplied	4420	$A^2\sqrt{s}$

**ELECTRICAL SPECIFICATIONS**

PARAMETER	SYMBOL	TEST CONDITIONS	VALUES	UNITS
Maximum forward voltage drop	$V_{FM}$	20 A, $T_J = 25\text{ }^\circ\text{C}$	1.1	V
Forward slope resistance	$r_t$	$T_J = 150\text{ }^\circ\text{C}$	10.4	$m\Omega$
Threshold voltage	$V_{F(TO)}$		0.85	V
Maximum reverse leakage current	$I_{RM}$	$T_J = 25\text{ }^\circ\text{C}$	0.1	mA
		$T_J = 150\text{ }^\circ\text{C}$	1.0	

**THERMAL - MECHANICAL SPECIFICATIONS**

PARAMETER	SYMBOL	TEST CONDITIONS	VALUES	UNITS
Maximum junction and storage temperature range	$T_J, T_{Stg}$		-40 to +150	$^\circ\text{C}$
Maximum thermal resistance, junction to case	$R_{thJC}$	DC operation	1.3	$^\circ\text{C/W}$
Typical thermal resistance, case to heatsink	$R_{thCS}$	Mounting surface, smooth, and greased	0.5	
Approximate weight			2	g
			0.07	oz.
Mounting torque	minimum		6 (5)	kgf · cm (lbf · in)
	maximum		12 (10)	
Marking device		Case style TO-220AC 2L	20ETS08	
			20ETS12	
		Case style TO-220AB 3L	20ATS08	
			20ATS12	

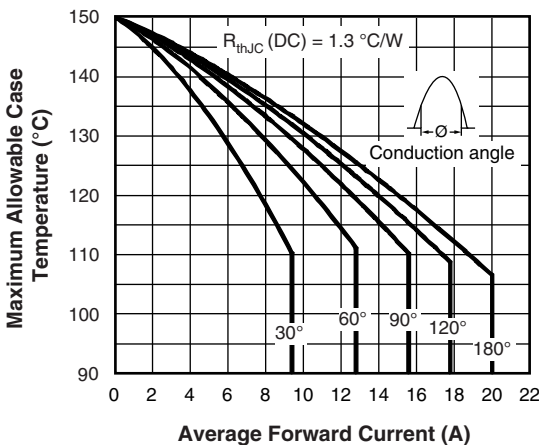

Fig. 1 - Current Rating Characteristics

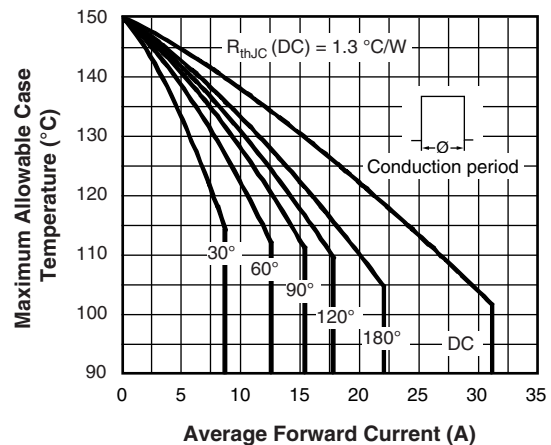

Fig. 2 - Current Rating Characteristics

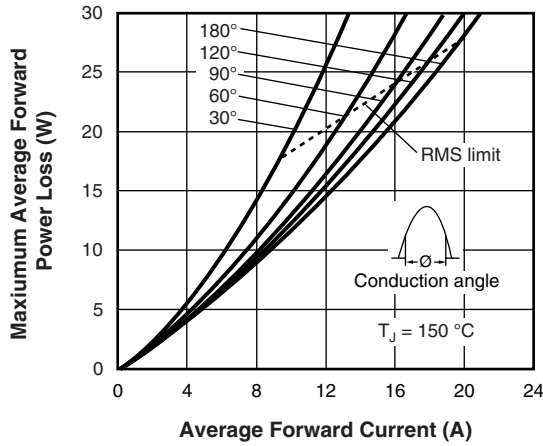

Fig. 3 - Forward Power Loss Characteristics

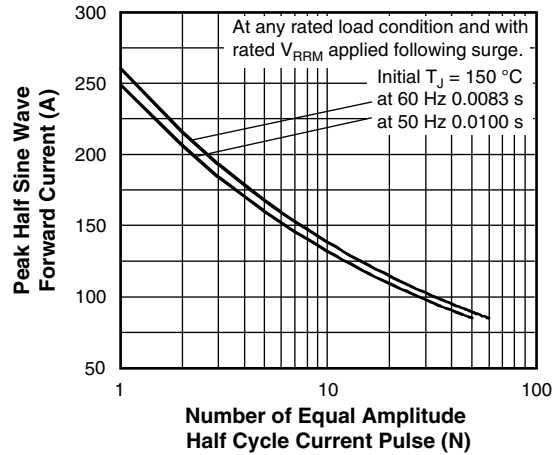

Fig. 5 - Maximum Non-Repetitive Surge Current

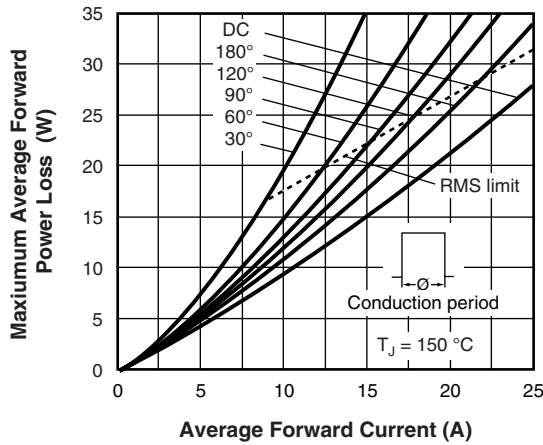

Fig. 4 - Forward Power Loss Characteristics

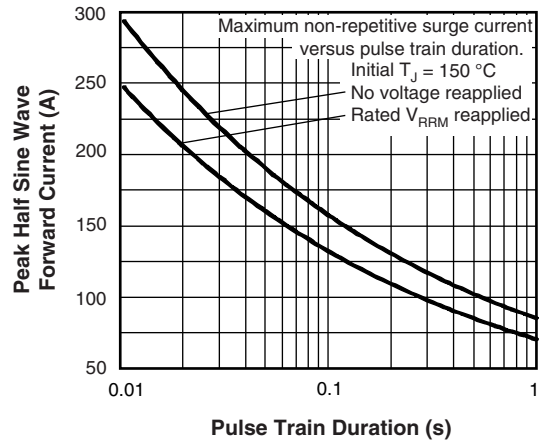

Fig. 6 - Maximum Non-Repetitive Surge Current

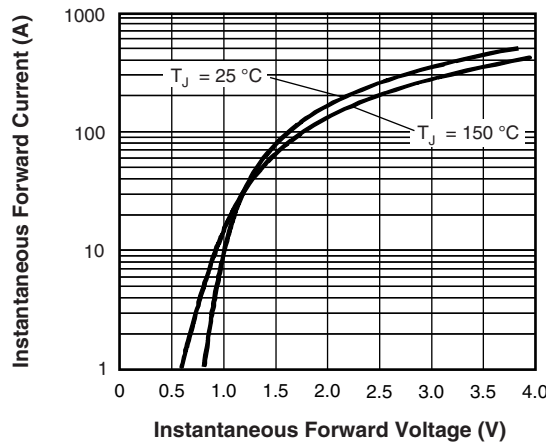
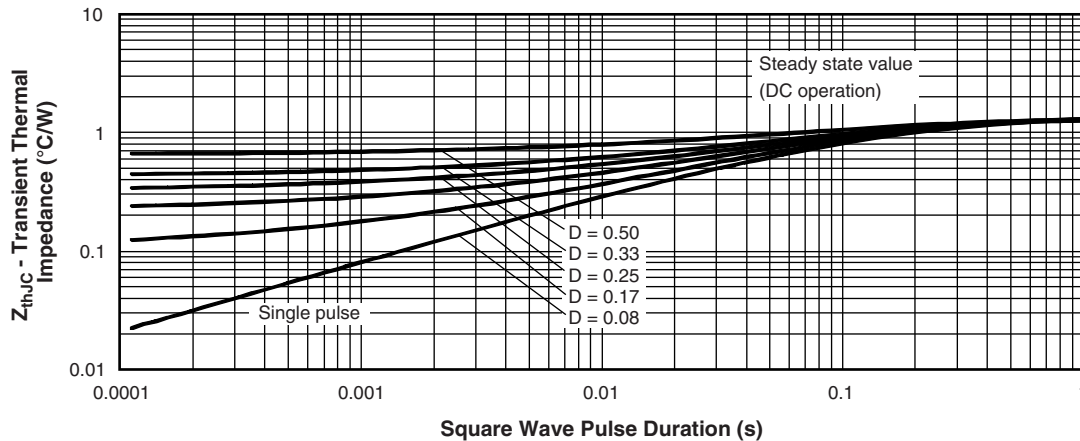

Fig. 7 - Forward Voltage Drop Characteristics

 Fig. 8 - Thermal Impedance  $Z_{thJC}$  Characteristics

**ORDERING INFORMATION TABLE**

Device code	<b>VS-</b>	<b>20</b>	<b>E</b>	<b>T</b>	<b>S</b>	<b>12</b>	<b>-M3</b>
	①	②	③	④	⑤	⑥	⑦

- 1** - Vishay Semiconductors product
- 2** - Current rating (20 = 20 A)
- 3** - Circuit configuration:  
E = 2L TO-220AC  
A = 3L TO-220AB
- 4** - Package:  
T = TO-220
- 5** - Type of silicon:  
S = standard recovery rectifier
- 6** - Voltage code  $\times 100 = V_{RRM}$ 

08 = 800 V
12 = 1200 V
- 7** - Environmental digit:  
-M3 = halogen-free, RoHS-compliant, and terminations lead (Pb)-free

**ORDERING INFORMATION (Example)**

PREFERRED P/N	BASE QUANTITY	PACKAGING DESCRIPTION
VS-20ATS08-M3	50	Antistatic plastic tubes
VS-20ATS12-M3	50	Antistatic plastic tubes
VS-20ETS08-M3	50	Antistatic plastic tubes
VS-20ETS12-M3	50	Antistatic plastic tubes

**LINKS TO RELATED DOCUMENTS**

Dimensions	2L TO-220AC	<a href="http://www.vishay.com/doc?96156">www.vishay.com/doc?96156</a>
	3L TO-220AB	<a href="http://www.vishay.com/doc?96154">www.vishay.com/doc?96154</a>
Part marking information	2L TO-220AC	<a href="http://www.vishay.com/doc?95391">www.vishay.com/doc?95391</a>
	3L TO-220AB	<a href="http://www.vishay.com/doc?95028">www.vishay.com/doc?95028</a>
SPICE model		<a href="http://www.vishay.com/doc?96046">www.vishay.com/doc?96046</a>

### TO-220AB 3L

**DIMENSIONS** in millimeters and inches

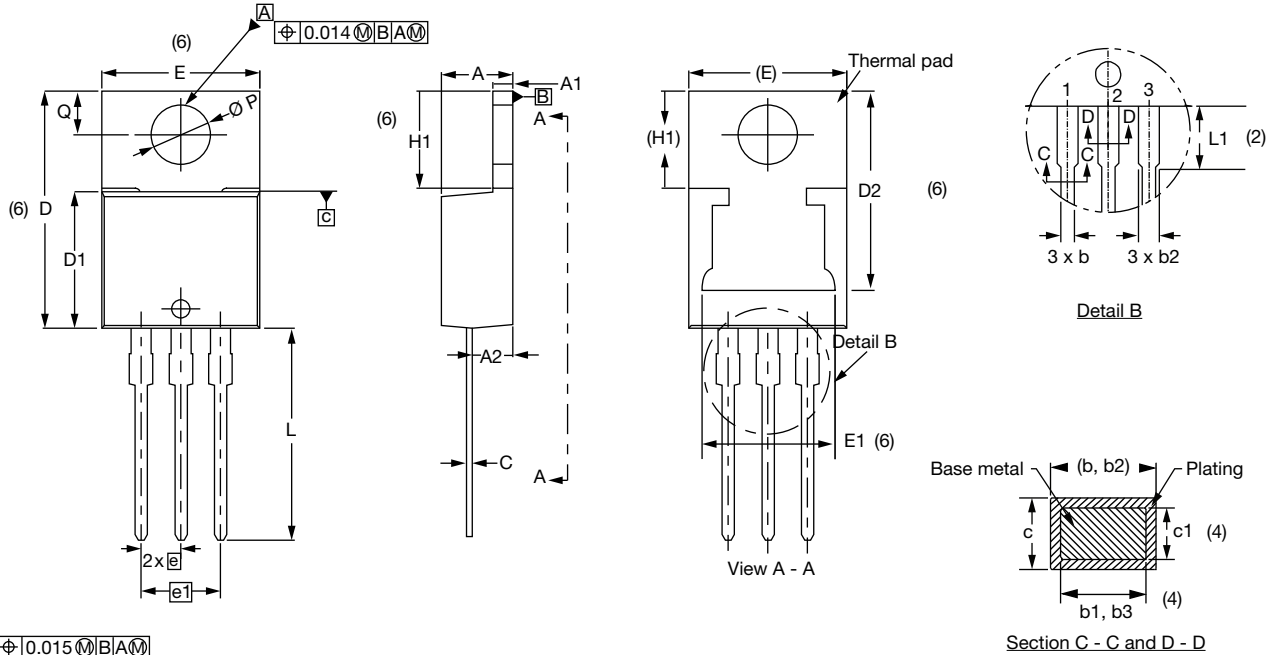

Conforms to JEDEC® outline TO-220AB

SYMBOL	MILLIMETERS		INCHES		NOTES
	MIN.	MAX.	MIN.	MAX.	
A	4.25	4.65	0.167	0.183	
A1	1.14	1.40	0.045	0.055	
A2	2.50	2.92	0.098	0.115	
b	0.69	1.01	0.027	0.040	
b1	0.38	0.97	0.015	0.038	4
b2	1.20	1.73	0.047	0.068	
b3	1.14	1.73	0.045	0.068	4
c	0.36	0.61	0.014	0.024	
c1	0.36	0.56	0.014	0.022	4
D	14.85	15.35	0.585	0.604	3
D1	8.38	9.02	0.330	0.355	
D2	11.68	13.30	0.460	0.524	6, 7
E	10.11	10.51	0.398	0.414	3, 6
E1	6.86	8.89	0.270	0.350	6
e	2.41	2.67	0.095	0.105	
e1	4.88	5.28	0.192	0.208	
H1	6.09	6.48	0.240	0.255	6
L	13.52	14.02	0.532	0.552	
L1	3.32	3.82	0.131	0.150	2
Ø P	3.54	3.91	0.139	0.154	
Q	2.60	3.00	0.102	0.118	

**Notes**

- (1) Dimensioning and tolerancing as per ASME Y14.5M-1994
- (2) Lead dimension and finish uncontrolled in L1
- (3) Dimension D, D1, and E do not include mold flash. Mold flash shall not exceed 0.127 mm (0.005") per side. These dimensions are measured at the outermost extremes of the plastic body
- (4) Dimension b1, b3, and c1 apply to base metal only
- (5) Controlling dimensions: inches
- (6) Thermal pad contour optional within dimensions E, H1, D2, and E1
- (7) Outline conforms to JEDEC® TO-220, except D2

### TO-220AC 2L

**DIMENSIONS** in millimeters and inches

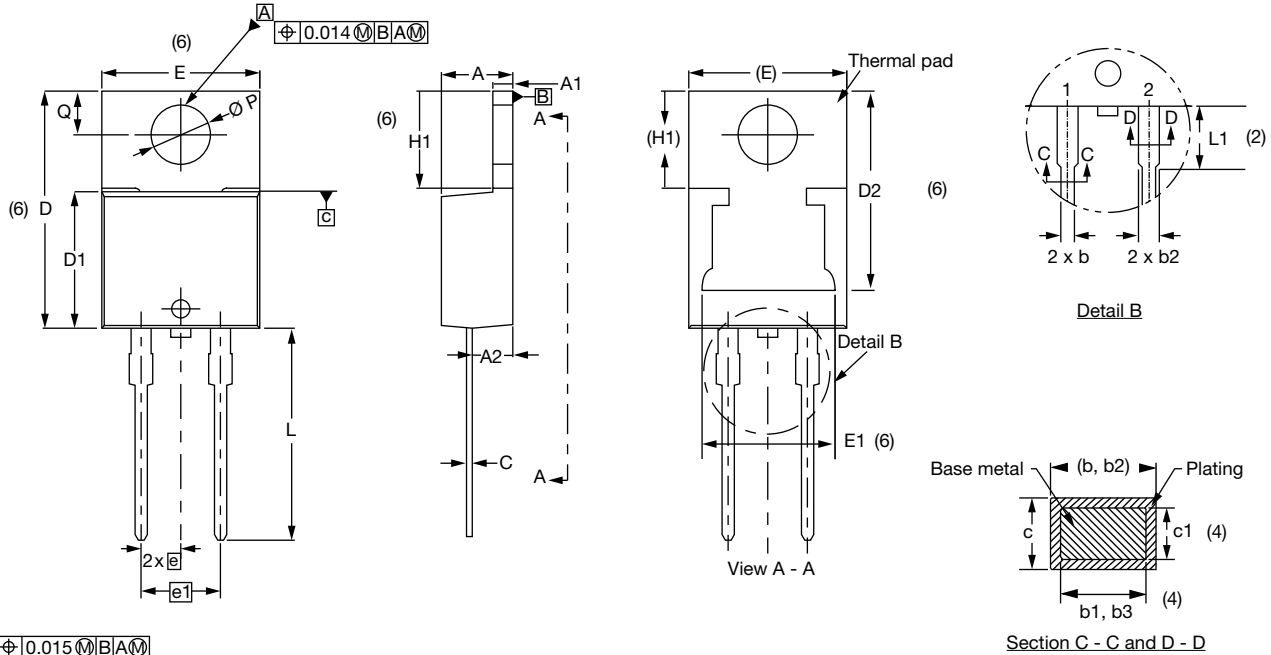

Conforms to JEDEC® outline TO-220AC

SYMBOL	MILLIMETERS		INCHES		NOTES
	MIN.	MAX.	MIN.	MAX.	
A	4.25	4.65	0.167	0.183	
A1	1.14	1.40	0.045	0.055	
A2	2.50	2.92	0.098	0.115	
b	0.69	1.01	0.027	0.040	
b1	0.38	0.97	0.015	0.038	4
b2	1.20	1.73	0.047	0.068	
b3	1.14	1.73	0.045	0.068	4
c	0.36	0.61	0.014	0.024	
c1	0.36	0.56	0.014	0.022	4
D	14.85	15.35	0.585	0.604	3
D1	8.38	9.02	0.330	0.355	
D2	11.68	13.30	0.460	0.524	6, 7
E	10.11	10.51	0.398	0.414	3, 6
E1	6.86	8.89	0.270	0.350	6
e	2.41	2.67	0.095	0.105	
e1	4.88	5.28	0.192	0.208	
H1	6.09	6.48	0.240	0.255	6
L	13.52	14.02	0.532	0.552	
L1	3.32	3.82	0.131	0.150	2
Ø P	3.54	3.91	0.139	0.154	
Q	2.60	3.00	0.102	0.118	

**Notes**

- (1) Dimensioning and tolerancing as per ASME Y14.5M-1994
- (2) Lead dimension and finish uncontrolled in L1
- (3) Dimension D, D1, and E do not include mold flash. Mold flash shall not exceed 0.127 mm (0.005") per side. These dimensions are measured at the outermost extremes of the plastic body
- (4) Dimension b1, b3, and c1 apply to base metal only
- (5) Controlling dimensions: inches
- (6) Thermal pad contour optional within dimensions E, H1, D2, and E1
- (7) Outline conforms to JEDEC® TO-220, except D2



## Disclaimer

ALL PRODUCT, PRODUCT SPECIFICATIONS AND DATA ARE SUBJECT TO CHANGE WITHOUT NOTICE TO IMPROVE RELIABILITY, FUNCTION OR DESIGN OR OTHERWISE.

Vishay Intertechnology, Inc., its affiliates, agents, and employees, and all persons acting on its or their behalf (collectively, "Vishay"), disclaim any and all liability for any errors, inaccuracies or incompleteness contained in any datasheet or in any other disclosure relating to any product.

Vishay makes no warranty, representation or guarantee regarding the suitability of the products for any particular purpose or the continuing production of any product. To the maximum extent permitted by applicable law, Vishay disclaims (i) any and all liability arising out of the application or use of any product, (ii) any and all liability, including without limitation special, consequential or incidental damages, and (iii) any and all implied warranties, including warranties of fitness for particular purpose, non-infringement and merchantability.

Statements regarding the suitability of products for certain types of applications are based on Vishay's knowledge of typical requirements that are often placed on Vishay products in generic applications. Such statements are not binding statements about the suitability of products for a particular application. It is the customer's responsibility to validate that a particular product with the properties described in the product specification is suitable for use in a particular application. Parameters provided in datasheets and / or specifications may vary in different applications and performance may vary over time. All operating parameters, including typical parameters, must be validated for each customer application by the customer's technical experts. Product specifications do not expand or otherwise modify Vishay's terms and conditions of purchase, including but not limited to the warranty expressed therein.

Hyperlinks included in this datasheet may direct users to third-party websites. These links are provided as a convenience and for informational purposes only. Inclusion of these hyperlinks does not constitute an endorsement or an approval by Vishay of any of the products, services or opinions of the corporation, organization or individual associated with the third-party website. Vishay disclaims any and all liability and bears no responsibility for the accuracy, legality or content of the third-party website or for that of subsequent links.

Except as expressly indicated in writing, Vishay products are not designed for use in medical, life-saving, or life-sustaining applications or for any other application in which the failure of the Vishay product could result in personal injury or death. Customers using or selling Vishay products not expressly indicated for use in such applications do so at their own risk. Please contact authorized Vishay personnel to obtain written terms and conditions regarding products designed for such applications.

No license, express or implied, by estoppel or otherwise, to any intellectual property rights is granted by this document or by any conduct of Vishay. Product names and markings noted herein may be trademarks of their respective owners.