

SERIES: VPOL15A-5-SMT | **DESCRIPTION:** POINT OF LOAD CONVERTER

FEATURES

- industry standard pin out
- high efficiency to 94%
- 300 KHz switching frequency
- 3.0-5.5 VDC input range
- 0.9-3.63 VDC wide output range
- over temperature protection
- continuous short circuit protection
- remote on/off
- cost-efficient open frame design
- UL/C-UL 60950 (E222736) certified

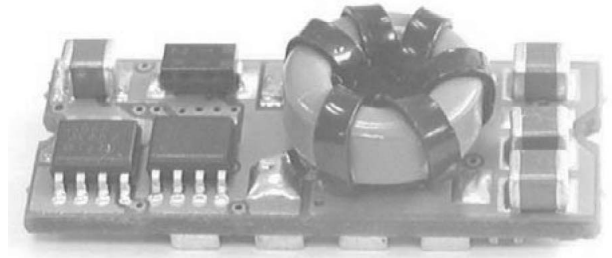

MODEL

MODEL	input voltage		output voltage (Vdc)	output current max (A)	output power max (W)	ripple and noise ¹ max (mVp-p)	efficiency typ (%)
	typ (Vdc)	range (Vdc)					
VPOL15A-5-SMT	5	3.0~5.5	1.0	15	15.0	50	82
		3.0~5.5	1.2		18.0	50	84
		3.0~5.5	1.5		22.5	50	87
		3.0~5.5	1.8		27.0	50	88
		3.0~5.5	2.0		30.0	50	89
		3.0~5.5	2.5		37.5	50	92
		4.5~5.5	3.3		49.5	50	94

Notes: 1. Ripple and noise are measured at 20 MHz BW by "parallel cable" method with 1 µF ceramic and 10 µF electrolytic capacitors on the output.

PART NUMBER KEY

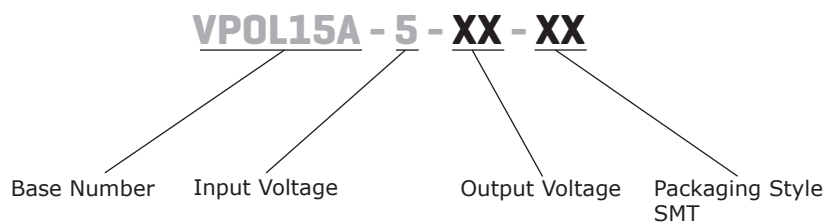

INPUT

parameter	conditions/description	min	typ	max	units
operating input voltage		3.0	5.0	5.5	Vdc
input under-voltage lockout	turn-on voltage treshold		2.8		Vdc
	turn-off voltage treshold		2.7		Vdc
	lockout hysteresis voltage		0.1		Vdc
input current	3.0~5.5 Vdc			15.5	A
no load input current	1.0 output		60		mA
	1.2 output		60		mA
	1.5 output		60		mA
	1.8 output		70		mA
	2.0 output		70		mA
	2.5 output		70		mA
	3.3 output		70		mA
off converter input current	shutdown input idle current		5	10	mA
inrush current				0.4	A ² s
input reflected-ripple current	P-P thru 1 μ H inductor, 5Hz to 20MHz		150		mA

OUTPUT

parameter	conditions/description	min	typ	max	units
capacitive load	low ESR			10,000	μ F
output voltage set point	at nominal input		± 1.5		Vdc
trim adjustment range	selected by an external resistor	0.9		3.63	Vdc
line regulation	low to high		± 0.2		%
			± 0.4		%
load regulation	10~100% load		± 0.5		%
operating current range		0		15	A
transient response deviation	25% load step change		± 5		%
switching frequency			300		kHz
remote on/off	positive logic logic low (module off) logic high (module on)	or open circuit	0	0.4	Vdc
	negative logic logic low (module off) logic high (module on)	or open circuit	0 2.8	0.4	Vdc
leakage current				1	mA
start-up time				1	ms
rise time			3.5	6	ms
temperature coefficient	-40~85°C			± 0.03	%/°C

PROTECTIONS

parameter	conditions/description	min	typ	max	units
short circuit protection	continuous, hiccup				
over temperature protection			120		°C

SAFETY AND COMPLIANCE

parameter	conditions/description	min	typ	max	units
safety approvals	60950-1: UL/cUL				
MTBF	as per MIL-HDBK-217F @ 25°C	1,500,000			hours
RoHS	yes				

ENVIRONMENTAL

parameter	conditions/description	min	typ	max	units
operating temperature	see derating curve	-40		85	°C
storage temperature		-55		125	°C

DERATING CURVES

Figure 1

**TEMPERATURE DERATING CURVE
(5 Vdc input & 3.3 Vdc output)**

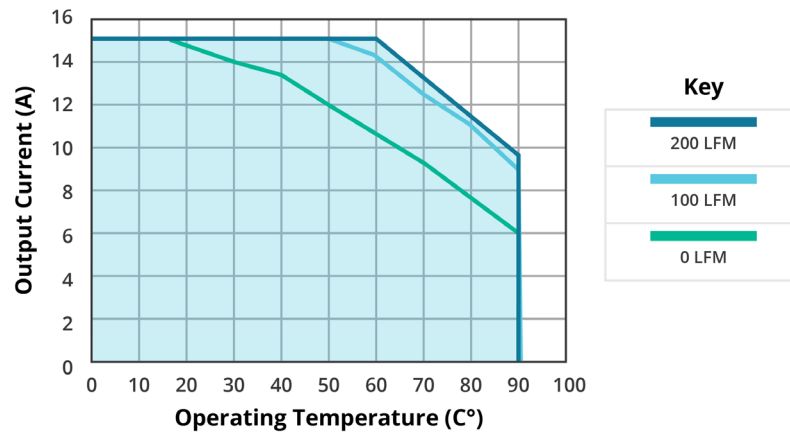

MECHANICAL

parameter	conditions/description	min	typ	max	units
dimensions	33.0 x 13.46 x 9.30 [1.30 x 0.530 x 0.366]				mm
weight			6.8		g

MECHANICAL DRAWING

units: inches [mm]

tolerance: x.xx ±0.02 [±0.5], x.xxx ±0.010 [0.25]

PIN CONNECTIONS	
Pin	Function
1	+Vin
2	Common
3	+Vo
4	Trim
5	+Sense
6	REM

BOTTOM VIEW OF BOARD

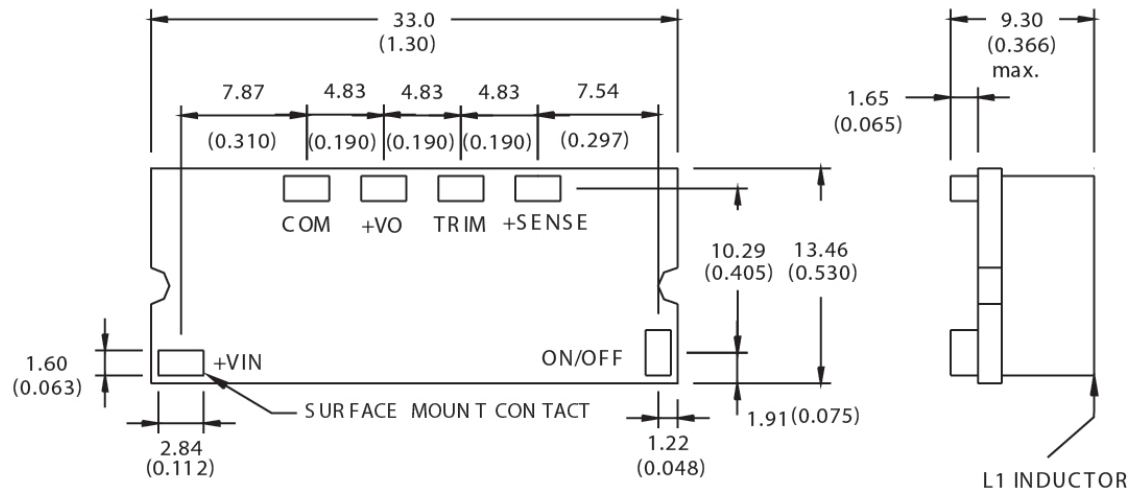

EFFICIENCY CURVES

EFFICIENCY VS OUTPUT CURRENT
VPOL15A-5-SMT
(Vo = 3.3 Vdc)

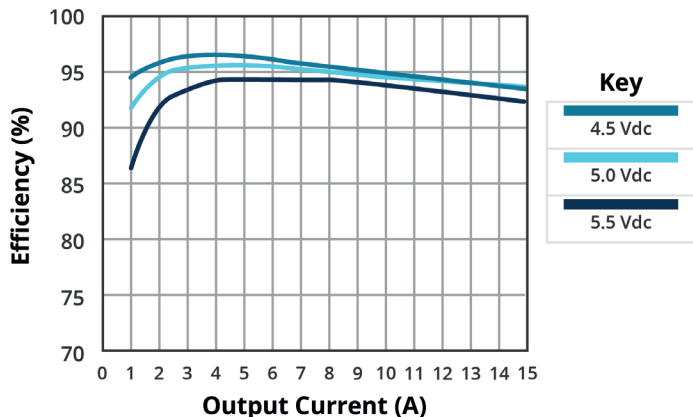

EFFICIENCY VS OUTPUT CURRENT
VPOL15A-5-SMT
(Vo = 2.5 Vdc)

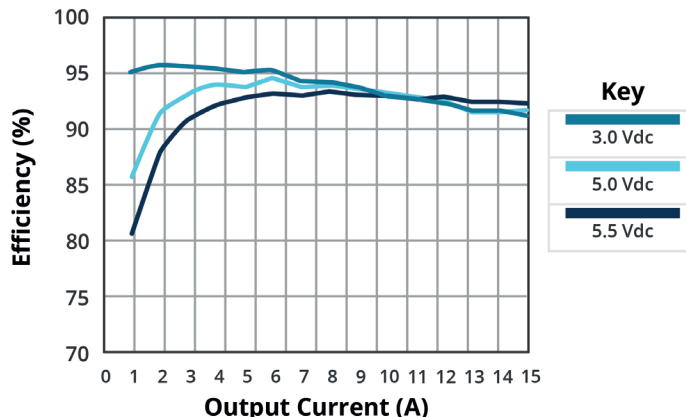

EFFICIENCY VS OUTPUT CURRENT
VPOL15A-5-SMT
(Vo = 1.8 Vdc)

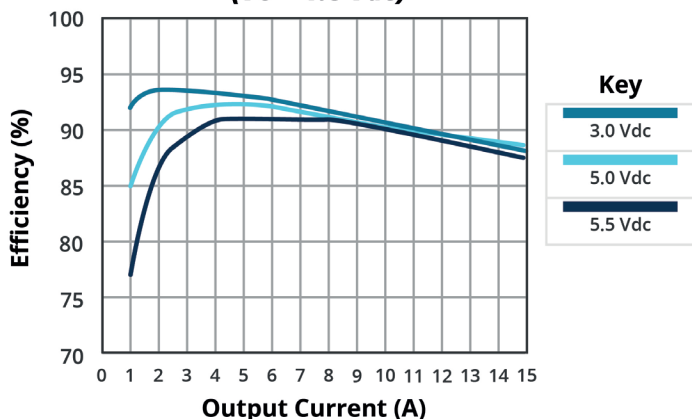

EFFICIENCY VS OUTPUT CURRENT
VPOL15A-5-SMT
(Vo = 1.5 Vdc)

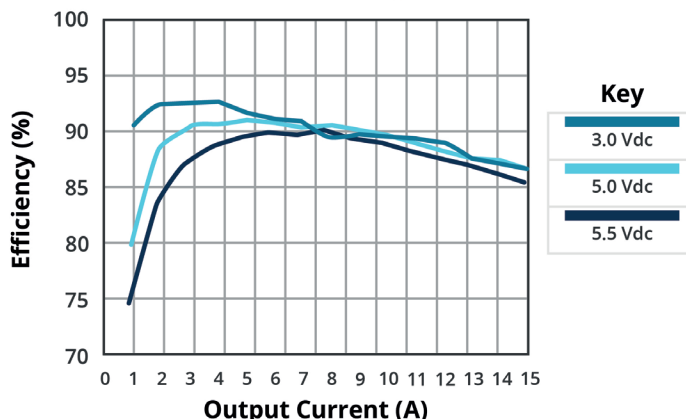

EFFICIENCY VS OUTPUT CURRENT
VPOL15A-5-SMT
(Vo = 1.2 Vdc)

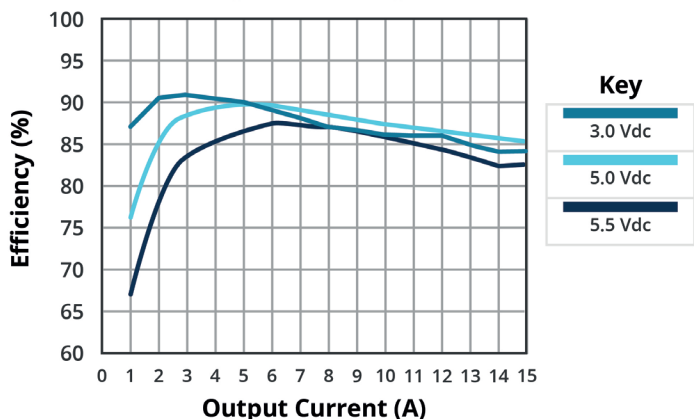

EFFICIENCY VS OUTPUT CURRENT
VPOL15A-5-SMT
(Vo = 1.0 Vdc)

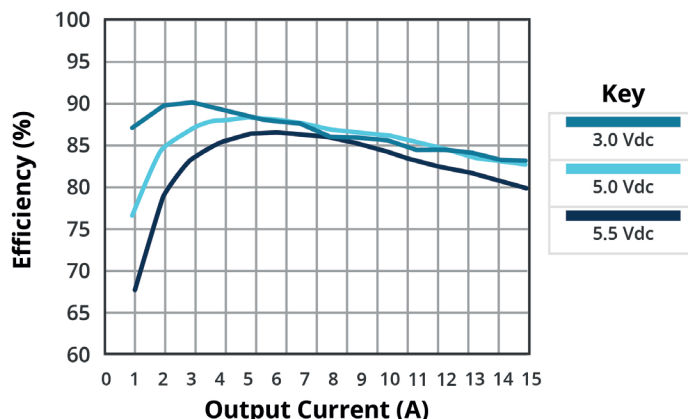

THEORY OF OPERATION

A block diagram of the VPOL15A-5-SMT Series converter is shown in Figure 2. Extremely high efficiency power conversion is achieved through the use of synchronous rectification and drive techniques. Essentially, the powerful VPOL15A-5-SMT series topology is based on a non-isolated synchronous buck converter. The control loop is optimized for unconditional stability, fast transient response and a very tight line and load regulation. In a typical pre-bias application the VPOL15A-5-SMT series converters do not draw any reverse current at start-up. The output voltage can be adjusted from 0.9 to 3.63vdc, using the TRIM pin with a external resistor. The converter can be shut down via a remote on/off input that is referenced to ground. This input is compatible with popular logic devices; a 'positive' logic input is supplied as standard. Positive logic implies that the converter is enabled if the remote on/off input is high (or floating), and disabled if it is low. The converter is also protected against over-temperature conditions. If the converter is overloaded or the ambient temperature gets too high, the converter will shut down to protect the unit.

Figure 2

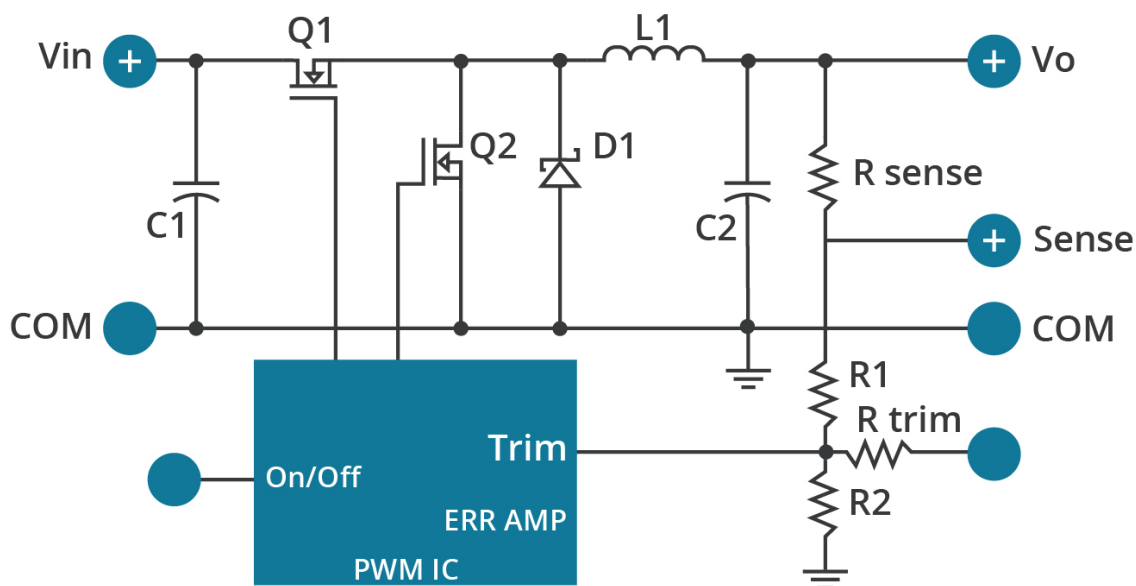

TYPICAL APPLICATION CIRCUITS

The VPOL15A-5-SMT converters must be connected to a low AC source impedance. To avoid problems with loop stability source inductance should be low. Also, the input capacitors should be placed close to the converter input pins to de-couple distribution inductance. However, the external input capacitors are chosen for suitable ripple handling capability. Low ESR polymers are a good choice. They have high capacitance, high ripple rating and low ESR (typical <20mΩ). Electrolytic capacitors should be avoided. Circuit as shown in Figure 3 represents typical measurement methods for ripple current. Input reflected-ripple current is measured with a simulated source Inductance of 1μH. Current is measured at the input of the module.

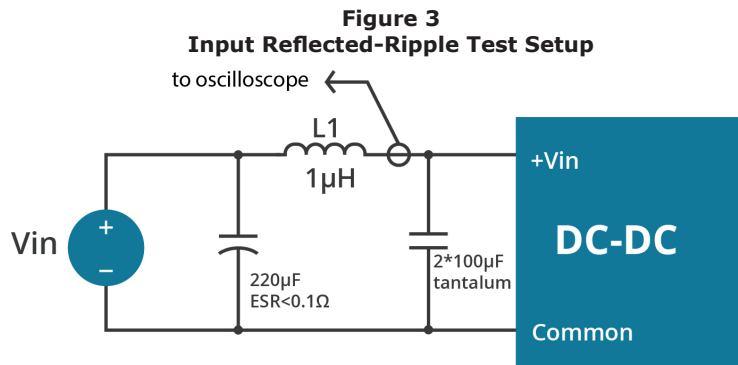

The basic test set-up to measure parameters such as efficiency and load regulation is shown in Figure 4. Things to note are that this converter is non-isolated, as such the input and output share a common ground. These grounds should be connected together via low impedance ground plane in the application circuit. When testing a converter on a bench set-up, ensure that -Vin and -Vo are connected together via a low impedance short to ensure proper efficiency and load regulation measurements are being made. When testing the CUI INC's VPOL15A-5-SMT series under any transient conditions please ensure that the transient response of the source is sufficient to power the equipment under test We can calculate the Efficiency, Load regulation and Line regulation.

The value of efficiency is defined as:

$$Efficiency = \frac{V_o \times I_o}{V_{in} \times I_{in}} \times 100\%$$

Note: V_o is output voltage, I_o is output current, V_{in} is input voltage, I_{in} is input current.

The value of load regulation is defined as:

$$Line.reg = \frac{V_{HL} - V_{LL}}{V_{LL}} \times 100\%$$

Note: V_{HL} is the output voltage of max input voltage at full load.
 V_{LL} is the output voltage of min input voltage at full load.

The value of load regulation is defined as:

$$Load.reg = \frac{V_{FL} - V_{NL}}{V_{NL}} \times 100\%$$

Note: V_{FL} is the output voltage at full load.
 V_{NL} is the output voltage at no load.

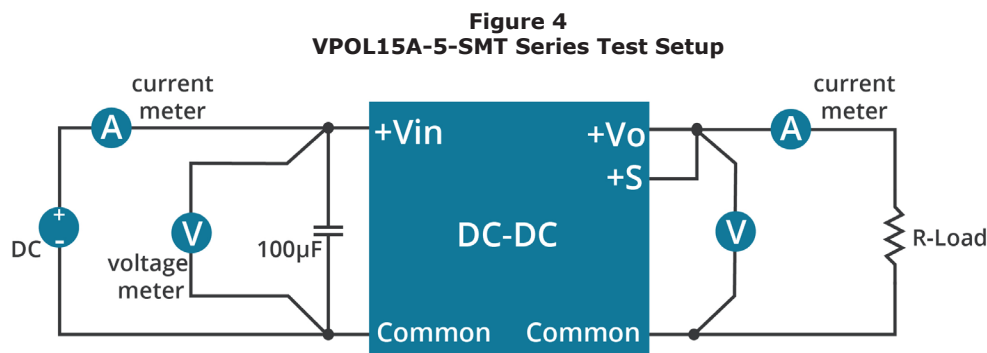

TYPICAL APPLICATION CIRCUITS (CONTINUED)

The output voltage of the VPOL15A-5-SMT can be adjusted in the range 0.9V to 3.63V by connecting a single resistor on the motherboard (shown as Rtrim) in Figure 5. When trim resistor is not connected the output voltage defaults to 0.75V

Figure 5
Trim-up Voltage Setup

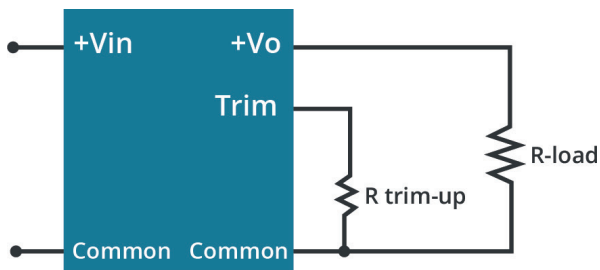

The value of Rtrim-up defined as:

$$R_{trim} = \left(\frac{21070}{V_o - 0.75} - 5110 \right)$$

Note: Rtrim-up is the external resistor in Ω, Vo is the desired output voltage

To give an example of the above calculation, to set a voltage of 3.3 Vdc.

Rtrim is given by:

$$R_{trim} = \left(\frac{21070}{V_o - 0.75} - 5110 \right)$$

Note: Rtrim = 3153 Ω

For various output values various resistors are calculated and provided in Table 1 for convenience:

Table 1
Trim Resistor Values

Vo, set (V)	Rtrim (kΩ)
0.90	135.36
1.00	79.17
1.20	41.71
1.50	22.98
1.80	14.96
2.00	11.75
2.50	6.93
3.30	3.15
3.63	2.20

TYPICAL APPLICATION CIRCUITS (CONTINUED)

Remote on/off

The remote on/off input feature of the converter allows external circuitry to turn the converter on or off. Active-high remote on/off is available as standard. The VPOL15A-5-SMT series converters are turned on if the remote on/off pin is high, or left open or floating. Setting the pin low will turn the converter 'Off'. The signal level of the remote on/off input is defined with respect to ground. If not using the remote on/off pin, leave the pin open (module will be on). The part number suffix "N" is negative remote on/off version. The unit is guaranteed off over the full temperature range if this voltage level exceeds 2.8Vdc. The converters are turned on if the on/off pin input is low or left open. The recommended VPOL15A-5-SMT remote on/off drive circuit as shown in Figures 6 & 7.

Figure 6
Positive Remote on/off Input Drive Circuit

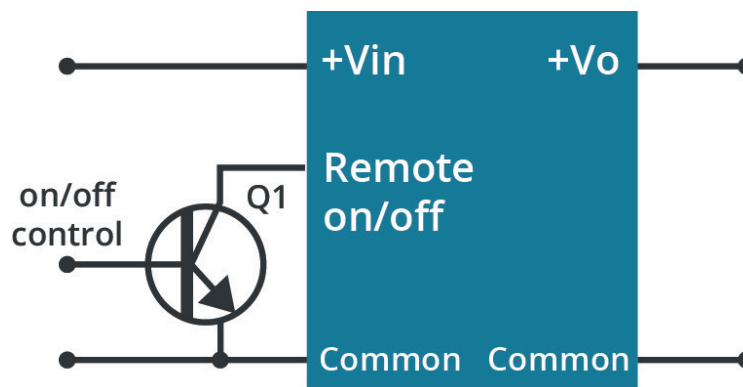
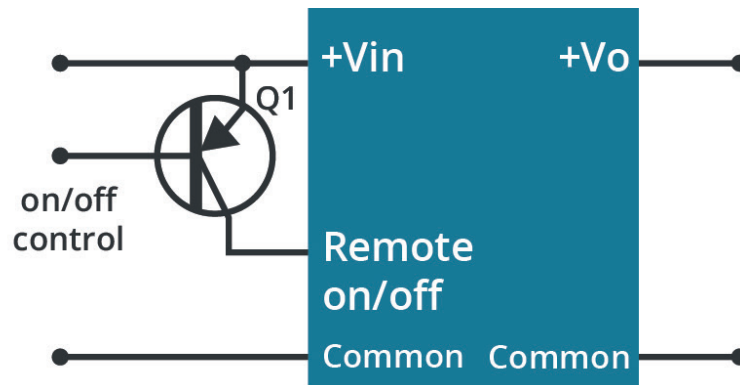

Figure 7
Negative Remote On/Off Input Drive Circuit



REMOTE SENSE COMPENSATION

Remote sense regulates the output voltage at the point of load. It minimizes the effects of distribution losses such as drops across the connecting pin and PCB tracks (see Figure 8). Please note however, the maximum drop from the output pin to the point of load should not exceed 500mV for remote compensation to work. The amount of power delivered by the module is defined as the output voltage multiplied by the output current ($V_O \times I_O$). When using "Trim Up", the output voltage of the module will increase which, if the same output current is maintained, increases the power output by the module. Make sure that the maximum output power of the module remains at or below the maximum rated power. When the remote sense feature is not being used, leave sense pin disconnected.

Figure 8
Circuit Configuration for Remote Sense Operation

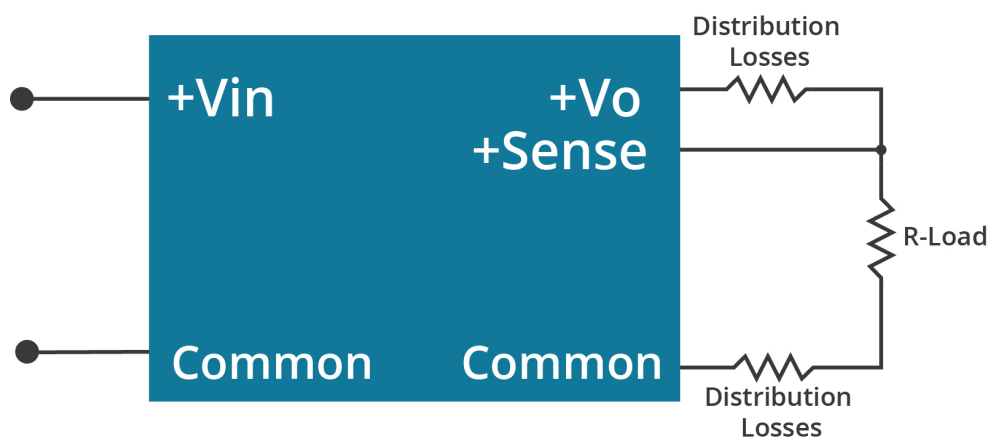

OUTPUT RIPPLE AND NOISE MEASUREMENT

The test set-up for noise and ripple measurements is shown in Figure 9 a coaxial cable with a 50 Ω termination was used to prevent impedance mismatch reflections disturbing the noise readings at higher frequencies.

Figure 9
Output Voltage Ripple and Noise Measurement Set-up

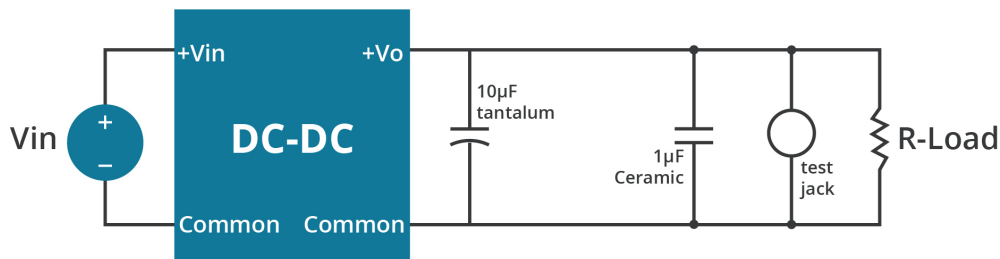

Output Capacitance

CUI INC's VPOL15A-5-SMT series converters provide unconditional stability with or without external capacitors. For good transient response low ESR output capacitors should be located close to the point of load. For high current applications point has already been made in layout considerations for low resistance and low inductance tracks. Output capacitors with its associated ESR values have an impact on loop stability and bandwidth. CUI INC's converters are designed to work with load capacitance up-to 10,000 μF . It is recommended that any additional capacitance, typically 1,000 μF and low ESR ($<20m\Omega$), be connected close to the point of load and outside the remote compensation point.

REVISION HISTORY

rev.	description	date
1.0	initial release	08/01/2007
1.01	datasheet updated to a new template	11/02/2021

The revision history provided is for informational purposes only and is believed to be accurate.



CUI INC
a bel group

Headquarters
20050 SW 112th Ave.
Tualatin, OR 97062
800.275.4899

Fax 503.612.2383
cui.com
techsupport@cui.com

CUI offers a two (2) year limited warranty. Complete warranty information is listed on our website.

CUI reserves the right to make changes to the product at any time without notice. Information provided by CUI is believed to be accurate and reliable. However, no responsibility is assumed by CUI for its use, nor for any infringements of patents or other rights of third parties which may result from its use.

CUI products are not authorized or warranted for use as critical components in equipment that requires an extremely high level of reliability. A critical component is any component of a life support device or system whose failure to perform can be reasonably expected to cause the failure of the life support device or system, or to affect its safety or effectiveness.