

## Optocoupler, Phototriac Output, Non-Zero Crossing, High dV/dt, Low Input Current

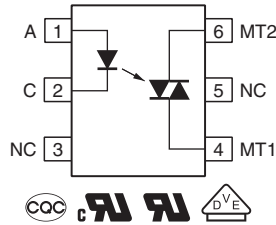

23043



### FEATURES

- High isolation distance on output
- High static dV/dt 1000 V/ $\mu$ s
- High input sensitivity  $I_{FT} = 10$  mA
- 100 mA on-state current
- 800 V peak off-state blocking voltage
- Isolation rated voltage 5000 V<sub>RMS</sub>
- Material categorization: for definitions of compliance please see [www.vishay.com/doc?99912](http://www.vishay.com/doc?99912)



### APPLICATIONS

- Power TRIAC driver in solid-state relays
- 3-phase AC equipment
- Motor control
- Industrial control
- White goods / household equipment

### AGENCY APPROVALS

- [UL 1577](#)
- [cUL](#)
- [DIN EN 60747-5-5 \(VDE 0884-5\)](#), available with option "V"
- [CQC](#)

### DESIGN SUPPORT TOOLS

[click logo to get started](#)

### DESCRIPTION

The VOT8123A consists of a GaAs IRLED optically coupled to a photosensitive TRIAC packaged in a DIP-6 package.

The VOT8123A isolates low-voltage logic from 120 V<sub>AC</sub>, 240 V<sub>AC</sub>, and 380 V<sub>AC</sub> lines to control resistive, inductive, or capacitive loads including motors, solenoids, high current thyristors or TRIAC and relays.

### ORDERING INFORMATION

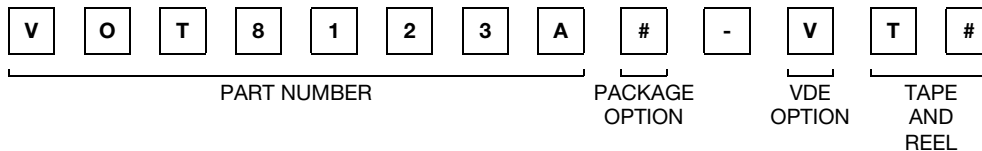

AGENCY CERTIFIED/PACKAGE	TRIGGER CURRENT, $I_{FT}$ (mA)
<b>UL, cUL, CQC</b>	<b>10</b>
DIP-6	VOT8123AD
DIP-6, 400 mil	VOT8123AG
SMD-6	VOT8123AB-T <sup>(1)</sup>
SMD-6, 180° orientation	VOT8123AB-T2
<b>VDE, UL, cUL, CQC</b>	<b>10</b>
DIP-6	VOT8123AD-V
DIP-6, 400 mil	VOT8123AG-V
SMD-6	VOT8123AB-VT <sup>(1)</sup>
SMD-6, 180° orientation	VOT8123AB-VT2

#### Note

<sup>(1)</sup> Also available in tubes; do not add T to end



ABSOLUTE MAXIMUM RATINGS ( $T_{amb} = 25\text{ }^{\circ}\text{C}$ , unless otherwise specified)				
PARAMETER	TEST CONDITION	SYMBOL	VALUE	UNIT
<b>INPUT</b>				
Reverse voltage		$V_R$	6	V
Forward current		$I_F$	50	mA
Power dissipation		$P_{diss}$	120	mW
Junction temperature		$T_j$	125	$^{\circ}\text{C}$
<b>OUTPUT</b>				
Peak off-state voltage		$V_{DRM}$	800	V
On-state current		$I_{T(RMS)}$	100	mA
Peak repetitive surge current	PW = 1 ms, 120 pps	$I_{TSM}$	1	A
Power dissipation		$P_{diss}$	300	mW
Junction temperature		$T_j$	125	$^{\circ}\text{C}$
<b>COUPLER</b>				
Storage temperature range		$T_{stg}$	-55 to +125	$^{\circ}\text{C}$
Ambient temperature range		$T_{amb}$	-40 to +110	$^{\circ}\text{C}$
Total power dissipation		$P_{diss}$	330	mW
Soldering temperature	For 10 s	$T_{sld}$	260	$^{\circ}\text{C}$

**Note**

- Stresses in excess of the absolute maximum ratings can cause permanent damage to the device. Functional operation of the device is not implied at these or any other conditions in excess of those given in the operational sections of this document. Exposure to absolute maximum ratings for extended periods of the time can adversely affect reliability. This phototriac should not be used to drive a load directly. It is intended to be a trigger device only

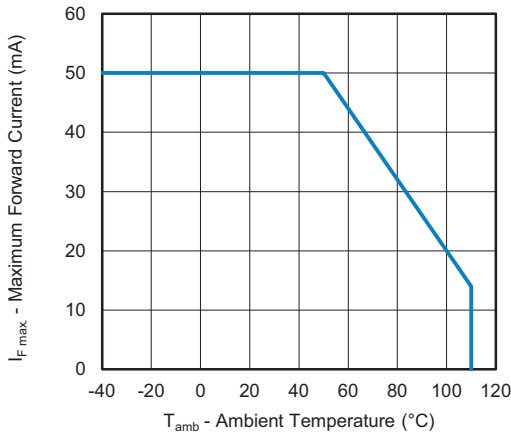

Fig. 1 - Maximum Forward Current vs. Ambient Temperature

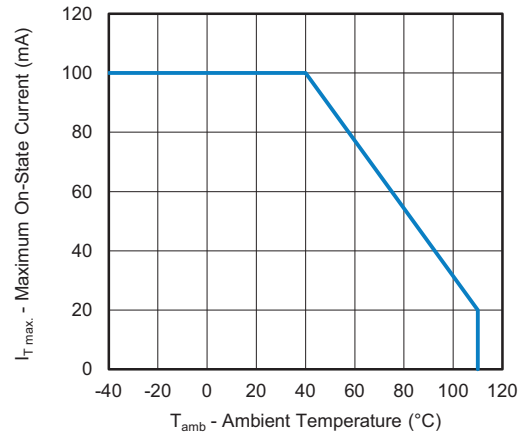

Fig. 2 - Maximum On-State Current vs. Ambient Temperature



<b>ELECTRICAL CHARACTERISTICS</b> ( $T_{amb} = 25\text{ }^{\circ}\text{C}$ , unless otherwise specified)						
PARAMETER	TEST CONDITION	SYMBOL	MIN.	TYP.	MAX.	UNIT
<b>INPUT</b>						
Forward voltage	$I_F = 20\text{ mA}$	$V_F$	-	1.2	1.4	V
Reverse current	$V_R = 6\text{ V}$	$I_R$	-	0.05	10	$\mu\text{A}$
<b>OUTPUT</b>						
Off-state current	$V_{DRM} = 800\text{ V}$	$I_{DRM}$	-	-	0.1	$\mu\text{A}$
On-state voltage	$I_T = 100\text{ mA peak}$	$V_{TM}$	-	-	3	V
Holding current		$I_H$	-	400	-	$\mu\text{A}$
Critical rate of rise of off-state voltage	$V_{IN} = 240\text{ V}_{RMS}$	$dV/dt^{(1)}$	1000	-	-	V/ $\mu\text{s}$
<b>COUPLER</b>						
Trigger current	$V_{TM} = 3\text{ V}$	$I_{FT}$	-	-	10	mA

**Notes**

- Minimum and maximum values were tested requirements. Typical values are characteristics of the device and are the result of engineering evaluations. Typical values are for information only and are not part of the testing requirements
- <sup>(1)</sup> Static  $dV/dt$

<b>SAFETY AND INSULATION RATINGS</b> ( $T_{amb} = 25\text{ }^{\circ}\text{C}$ , unless otherwise specified)				
PARAMETER	TEST CONDITION	SYMBOL	VALUE	UNIT
Climatic classification	According to IEC 68 part 1		55 / 115 / 21	
Comparative tracking index	Insulation group IIIa	CTI	175	
Maximum rated withstanding isolation voltage	According to UL1577, $t = 1\text{ min}$	$V_{ISO}$	5000	$V_{RMS}$
Maximum transient isolation voltage	According to DIN EN 60747-5-5	$V_{IOTM}$	8000	$V_{peak}$
Maximum repetitive peak isolation voltage	According to DIN EN 60747-5-5, DIP-6, SMD-6	$V_{IORM}$	890	$V_{peak}$
	According to DIN EN 60747-5-5, DIP-6, 400 mil	$V_{IORM}$	1140	$V_{peak}$
Isolation resistance	$V_{IO} = 500\text{ V}$ , $T_{amb} = 25\text{ }^{\circ}\text{C}$	$R_{IO}$	$\geq 10^{12}$	$\Omega$
	$V_{IO} = 500\text{ V}$ , $T_{amb} = 100\text{ }^{\circ}\text{C}$	$R_{IO}$	$\geq 10^{11}$	$\Omega$
Output safety power		$P_{SO}$	700	mW
Input safety current		$I_{SI}$	400	mA
Input safety temperature		$T_S$	175	$^{\circ}\text{C}$
Creepage distance	DIP-6, SMD-6		$\geq 7$	mm
Clearance distance			$\geq 7$	mm
Creepage distance	DIP-6, 400 mil		$\geq 8$	mm
Clearance distance			$\geq 8$	mm
Insulation thickness		DTI	$\geq 0.4$	mm

**Note**

- As per IEC 60747-5-5, § 7.4.3.8.2, this optocoupler is suitable for "safe electrical insulation" only within the safety ratings. Compliance with the safety ratings shall be ensured by means of protective circuits



TYPICAL CHARACTERISTICS (T<sub>amb</sub> = 25 °C, unless otherwise specified)

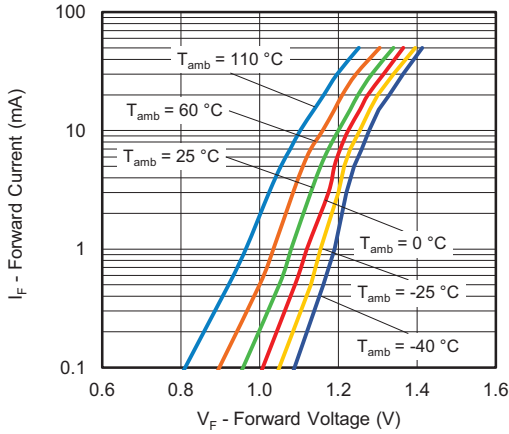

Fig. 3 - Forward Current vs. Forward Voltage

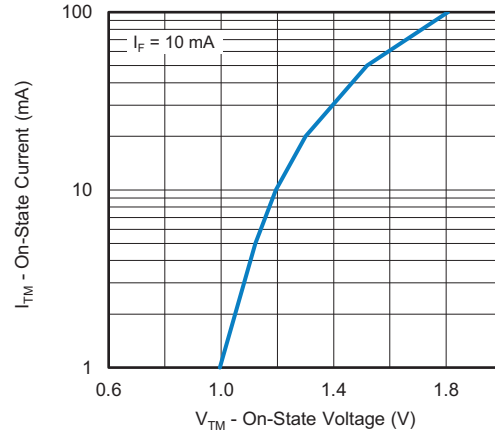

Fig. 6 - On State Current vs. On State Voltage

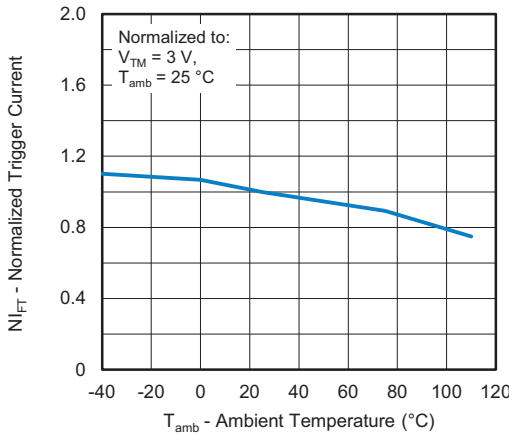

Fig. 4 - Normalized Trigger Current vs. Ambient Temperature

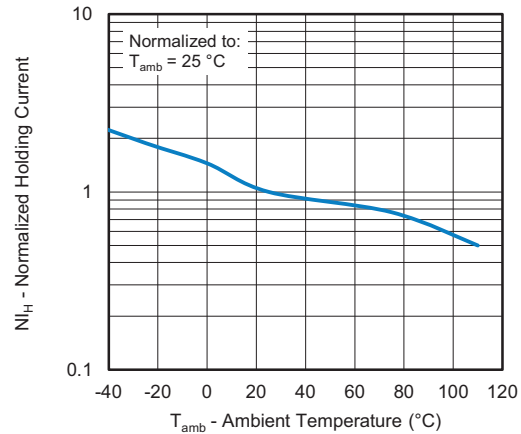

Fig. 7 - Normalized Holding Current vs. Ambient Temperature

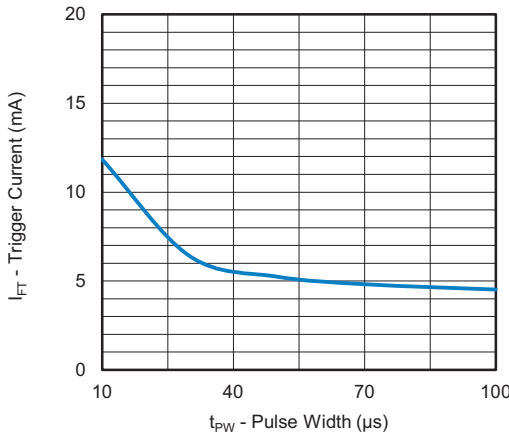

Fig. 5 - Trigger Current vs. Pulse Width

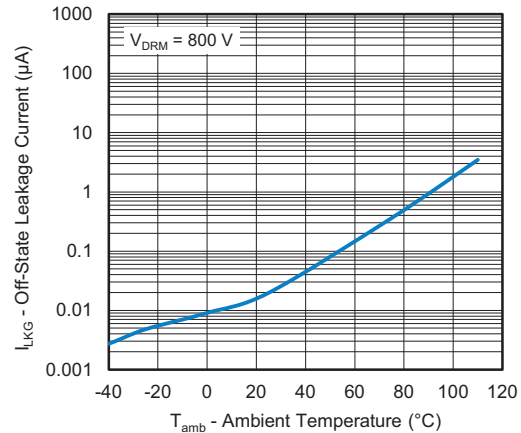

Fig. 8 - Off-State Leakage Current vs. Ambient Temperature



Fig. 9 - Turn-On Time vs. Forward Current

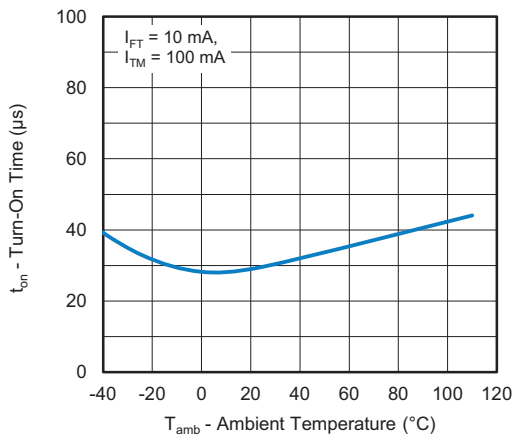

Fig. 10 - Turn-On Time vs. Ambient Temperature

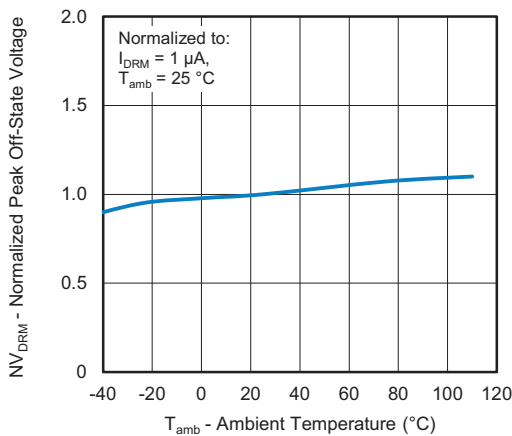

Fig. 11 - Normalized Peak Off-State Voltage vs. Ambient Temperature



## PACKAGE DIMENSIONS (in millimeters)

### DIP-6



23002

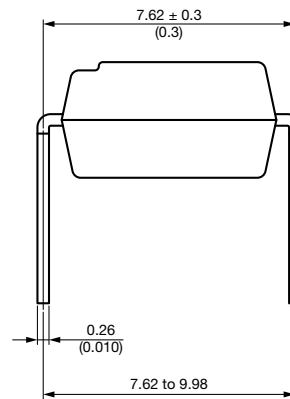
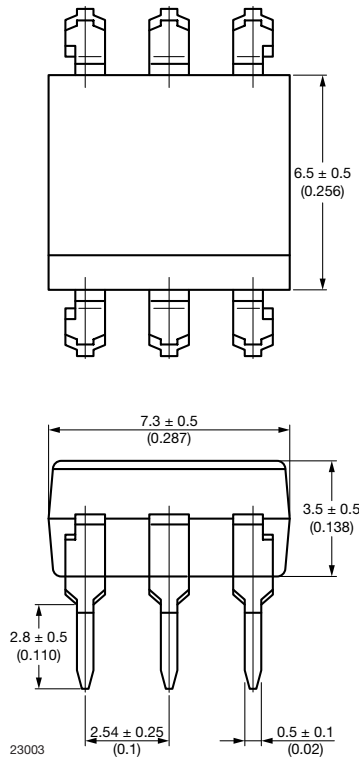

Fig. 1

### DIP-6, Gullwing



23003



Fig. 2

SMD-6



Fig. 3

**PACKAGE MARKING**

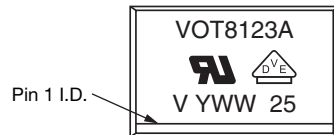

Fig. 12 - Example of VOT8123AD-VT

**Notes**

- “YWW” is the date code marking (Y = year code, WW = week code)
- VDE logo is only marked on VDE option parts
- Tape and reel suffix (T) is not part of the package marking



## PACKAGING INFORMATION (in millimeters)

DEVICES PER TUBE			
TYPE	UNITS/TUBE	TUBES/BOX	UNITS/BOX
DIP-6	50	40	2000
DIP-6, 400 mil	50	40	2000
SMD-6	50	40	2000

### SMD-6 Tape

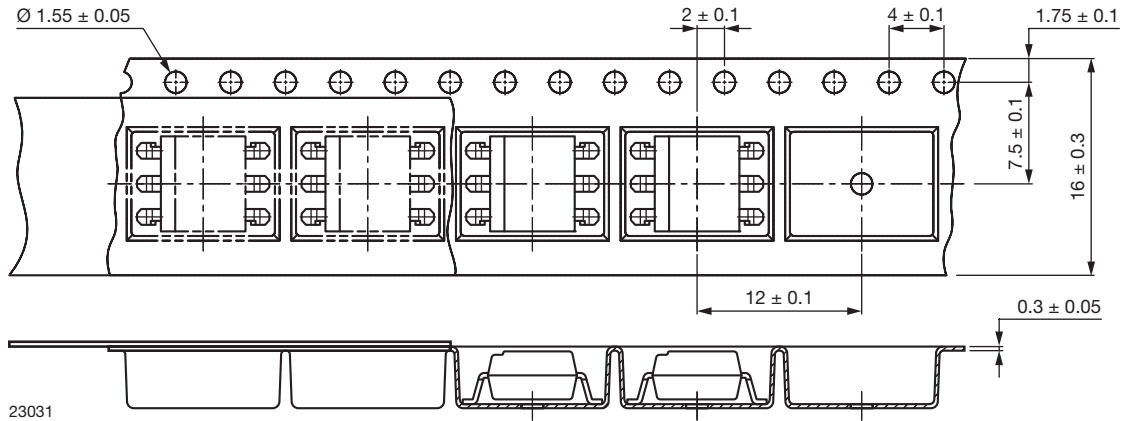

Fig. 13 - Tape and Reel Packaging (1000 pieces on reel)

### SMD-6 Tape, 180° Orientation

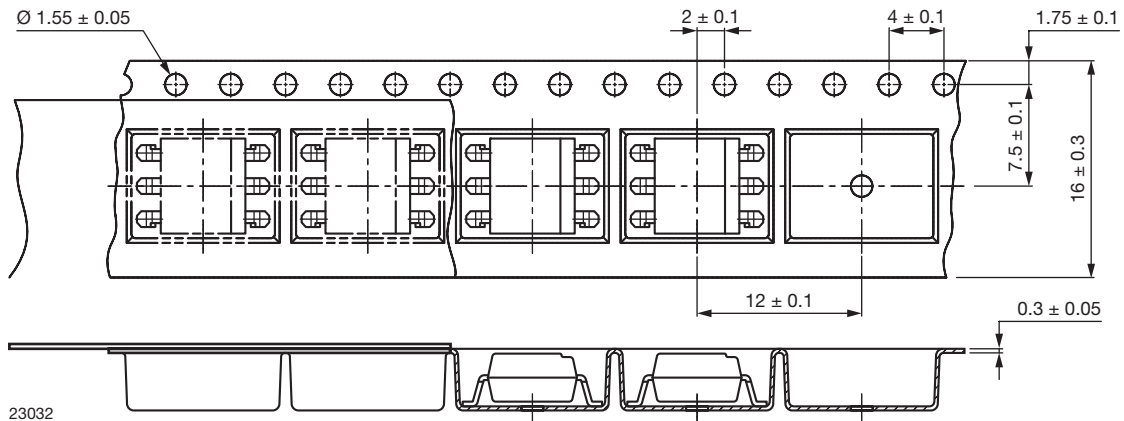

Fig. 14 - Tape and Reel Packaging (1000 pieces on reel)





Reel



Fig. 15 - Tape and Reel Shipping Medium

**SOLDER PROFILES**
**IR Reflow Soldering (JEDEC® J-STD-020C compliant)**

One time soldering reflow is recommended within the condition of temperature and time profile shown below. Do not solder more than three times.

PROFILE ITEM	CONDITIONS
Preheat	
- Temperature minimum ( $T_{S \text{ min.}}$ )	150 °C
- Temperature maximum ( $T_{S \text{ max.}}$ )	200 °C
- Time (min. to max.) ( $t_S$ )	90 s ± 30 s
Soldering zone	
- Temperature ( $T_L$ )	217 °C
- Time ( $t_L$ )	60 s
Peak temperature ( $T_p$ )	260 °C
Ramp-up rate	3 °C/s max.
Ramp-down rate	3 °C/s to 6 °C/s

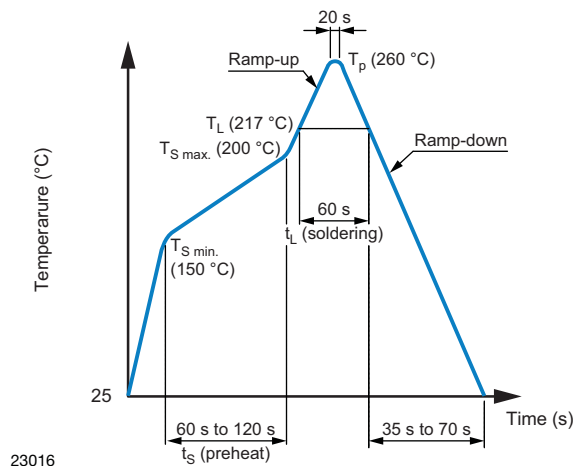

Fig. 4

**Wave Soldering (JEDEC JESD22-A111 compliant)**

One time soldering is recommended within the condition of temperature.

Temperature: 260 °C + 0 °C / - 5 °C

Time: 10 s

Preheat temperature: 25 °C to 140 °C

Preheat time: 30 s to 80 s



23017

Fig. 5

**Hand Soldering by Soldering Iron**

Allow single lead soldering in every single process. One time soldering is recommended.

Temperature: 380 °C + 0 °C / - 5 °C

Time: 3 s max.

**HANDLING AND STORAGE CONDITIONS**

ESD level: HBM class 2

Floor life: unlimited

Conditions:  $T_{\text{amb}} < 30 \text{ °C}$ , RH < 85 %

Moisture sensitivity level 1, according to J-STD-020



## Disclaimer

ALL PRODUCT, PRODUCT SPECIFICATIONS AND DATA ARE SUBJECT TO CHANGE WITHOUT NOTICE TO IMPROVE RELIABILITY, FUNCTION OR DESIGN OR OTHERWISE.

Vishay Intertechnology, Inc., its affiliates, agents, and employees, and all persons acting on its or their behalf (collectively, "Vishay"), disclaim any and all liability for any errors, inaccuracies or incompleteness contained in any datasheet or in any other disclosure relating to any product.

Vishay makes no warranty, representation or guarantee regarding the suitability of the products for any particular purpose or the continuing production of any product. To the maximum extent permitted by applicable law, Vishay disclaims (i) any and all liability arising out of the application or use of any product, (ii) any and all liability, including without limitation special, consequential or incidental damages, and (iii) any and all implied warranties, including warranties of fitness for particular purpose, non-infringement and merchantability.

Statements regarding the suitability of products for certain types of applications are based on Vishay's knowledge of typical requirements that are often placed on Vishay products in generic applications. Such statements are not binding statements about the suitability of products for a particular application. It is the customer's responsibility to validate that a particular product with the properties described in the product specification is suitable for use in a particular application. Parameters provided in datasheets and / or specifications may vary in different applications and performance may vary over time. All operating parameters, including typical parameters, must be validated for each customer application by the customer's technical experts. Product specifications do not expand or otherwise modify Vishay's terms and conditions of purchase, including but not limited to the warranty expressed therein.

Hyperlinks included in this datasheet may direct users to third-party websites. These links are provided as a convenience and for informational purposes only. Inclusion of these hyperlinks does not constitute an endorsement or an approval by Vishay of any of the products, services or opinions of the corporation, organization or individual associated with the third-party website. Vishay disclaims any and all liability and bears no responsibility for the accuracy, legality or content of the third-party website or for that of subsequent links.

Except as expressly indicated in writing, Vishay products are not designed for use in medical, life-saving, or life-sustaining applications or for any other application in which the failure of the Vishay product could result in personal injury or death. Customers using or selling Vishay products not expressly indicated for use in such applications do so at their own risk. Please contact authorized Vishay personnel to obtain written terms and conditions regarding products designed for such applications.

No license, express or implied, by estoppel or otherwise, to any intellectual property rights is granted by this document or by any conduct of Vishay. Product names and markings noted herein may be trademarks of their respective owners.