

# Optocoupler, Phototransistor Output, AC Input, Low Input Current, 4 Pin LSOP, Long Creepage Mini-Flat Package

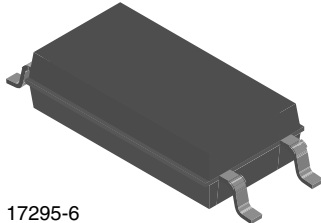

17295-6

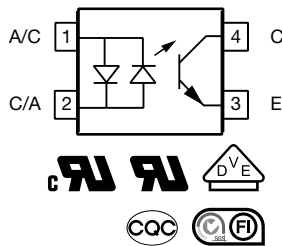

## DESCRIPTION

The VOL628A has two GaAs infrared emitting diodes, which are optically coupled to a silicon planar phototransistor detector, and are incorporated in a 4 pin long creepage mini-flat package.

It features a high current transfer ratio, low coupling capacitance, and high isolation voltage.

The coupling device is designed for signal transmission between two electrically separated circuits.

## FEATURES

- Low profile package
- High collector emitter voltage,  $V_{CEO} = 80\text{ V}$
- Isolation test voltage,  $5000\text{ V}_{RMS}$
- Low coupling capacitance
- High common mode transient immunity
- Material categorization:  
for definitions of compliance please see [www.vishay.com/doc?99912](http://www.vishay.com/doc?99912)



**RoHS**  
COMPLIANT  
HALOGEN  
**FREE**  
**GREEN**  
(5-2008)

## APPLICATIONS

- Industrial controls
- Power supplies
- AC line monitor
- Battery powered equipment
- Programmable logic controllers

## AGENCY APPROVALS

(All parts are certified under base model VOL628A)

- [UL1577](#)
- [cUL](#)
- [DIN EN 60747-5-5 \(VDE 0884-5\), available with option 1](#)
- [BSI](#)
- [FIMKO](#)
- [CQC GB4943.1-2011](#)
- [CQC GB8898-2011](#)

## LINKS TO ADDITIONAL RESOURCES



**SPICE**  
Models



<b>ORDERING INFORMATION</b>				
<div style="display: flex; justify-content: space-around; align-items: center;"> <div style="border: 1px solid black; padding: 2px 5px;">V</div> <div style="border: 1px solid black; padding: 2px 5px;">O</div> <div style="border: 1px solid black; padding: 2px 5px;">L</div> <div style="border: 1px solid black; padding: 2px 5px;">6</div> <div style="border: 1px solid black; padding: 2px 5px;">2</div> <div style="border: 1px solid black; padding: 2px 5px;">8</div> <div style="border: 1px solid black; padding: 2px 5px;">A</div> <div style="border: 1px solid black; padding: 2px 5px;">-</div> <div style="border: 1px solid black; padding: 2px 5px;">#</div> <div style="border: 1px solid black; padding: 2px 5px;">X</div> <div style="border: 1px solid black; padding: 2px 5px;">0</div> <div style="border: 1px solid black; padding: 2px 5px;">0</div> <div style="border: 1px solid black; padding: 2px 5px;">1</div> <div style="border: 1px solid black; padding: 2px 5px;">T</div> </div>	PART NUMBER	CTR BIN	PACKAGE OPTION	TAPE AND REEL
<b>AGENCY CERTIFIED / PACKAGE</b>	<b>CTR (%)</b>			
	<b>1 mA</b>			
<b>UL, cUL, BSI, FIMKO, CQC</b>	<b>50 to 600</b>	<b>63 to 125</b>	<b>100 to 200</b>	
LSOP-4, mini-flat, long creepage	VOL628AT	VOL628A-2T	VOL628A-3T	
<b>UL, cUL, BSI, FIMKO, CQC, VDE (option 1)</b>	<b>50 to 600</b>	<b>63 to 125</b>	<b>100 to 200</b>	
LSOP-4, mini-flat, long creepage	-	VOL628A-2X001T	VOL628A-3X001T	

**Note**

- Additional options may be possible, please contact sales office

<b>ABSOLUTE MAXIMUM RATINGS</b> ( $T_{amb} = 25\text{ }^{\circ}\text{C}$ , unless otherwise specified)				
PARAMETER	TEST CONDITION	SYMBOL	VALUE	UNIT
<b>INPUT</b>				
Reverse voltage		$V_R$	6	V
Power dissipation		$P_{diss}$	100	mW
Forward current		$I_F$	$\pm 60$	mA
Junction temperature		$T_j$	125	$^{\circ}\text{C}$
<b>OUTPUT</b>				
Collector emitter voltage		$V_{CEO}$	80	V
Emitter collector voltage		$V_{ECO}$	7	V
Collector current		$I_C$	50	mA
	$t_p/T = 0.5, t_p < 10\text{ ms}$	$I_C$	100	mA
Power dissipation		$P_{diss}$	150	mW
Junction temperature		$T_j$	125	$^{\circ}\text{C}$
<b>COUPLER</b>				
Total power dissipation		$P_{tot}$	250	mW
Storage temperature range		$T_{stg}$	-55 to +125	$^{\circ}\text{C}$
Ambient temperature range		$T_{amb}$	-55 to +110	$^{\circ}\text{C}$
Soldering temperature <sup>(1)</sup>	$\leq 10\text{ s}$	$T_{sld}$	260	$^{\circ}\text{C}$

**Notes**

- Stresses in excess of the absolute maximum ratings can cause permanent damage to the device. Functional operation of the device is not implied at these or any other conditions in excess of those given in the operational sections of this document. Exposure to absolute maximum ratings for extended periods of the time can adversely affect reliability
- <sup>(1)</sup> Refer to reflow profile for soldering conditions for surface mounted devices

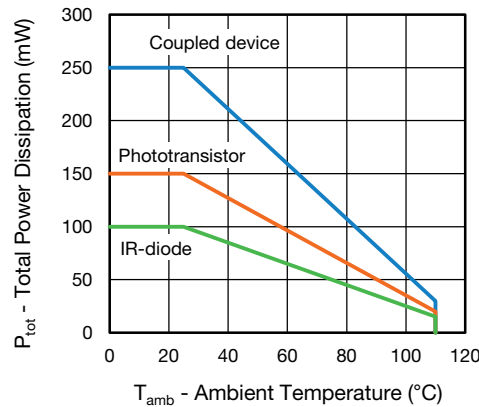

Fig. 1 - Total Power Dissipation vs. Ambient Temperature

<b>ELECTRICAL CHARACTERISTICS</b> ( $T_{amb} = 25\text{ }^{\circ}\text{C}$ , unless otherwise specified)							
PARAMETER	TEST CONDITION	PART	SYMBOL	MIN.	TYP.	MAX.	UNIT
<b>INPUT</b>							
Forward voltage	$I_F = \pm 5\text{ mA}$		$V_F$	-	1.16	1.5	V
Reverse current	$V_R = 6\text{ V}$		$I_R$	-	-	100	$\mu\text{A}$
Capacitance	$V_R = 0\text{ V}$ , $f = 1\text{ MHz}$		$C_O$	-	45	-	pF
<b>OUTPUT</b>							
Collector emitter leakage current	$V_{CE} = 10\text{ V}$ , $I_F = 0\text{ A}$		$I_{CEO}$	-	10	200	nA
Collector emitter capacitance	$V_{CE} = 5\text{ V}$ , $f = 1\text{ MHz}$		$C_{CE}$	-	7	-	pF
<b>COUPLER</b>							
Collector emitter saturation voltage	$I_C = 0.2\text{ mA}$ , $I_F = \pm 1\text{ mA}$	VOL628A	$V_{CEsat}$	-	0.25	0.4	V
	$I_C = 0.32\text{ mA}$ , $I_F = \pm 1\text{ mA}$	VOL628A-2T	$V_{CEsat}$	-	0.25	0.4	V
	$I_C = 0.5\text{ mA}$ , $I_F = \pm 1\text{ mA}$	VOL628A-3T	$V_{CEsat}$	-	0.25	0.4	V
Coupling capacitance	$f = 1\text{ MHz}$		$C_C$	-	0.25	-	pF

**Note**

- Minimum and maximum values are testing requirements. Typical values are characteristics of the device and are the result of engineering evaluation. Typical values are for information only and are not part of the testing requirements

<b>CURRENT TRANSFER RATIO</b> ( $T_{amb} = 25\text{ }^{\circ}\text{C}$ , unless otherwise specified)							
PARAMETER	TEST CONDITION	PART	SYMBOL	MIN.	TYP.	MAX.	UNIT
$I_C/I_F$	$I_F = \pm 1\text{ mA}$ , $V_{CE} = 5\text{ V}$	VOL628A	CTR	50	-	600	%
		VOL628A-2	CTR	63	-	125	%
		VOL628A-3	CTR	100	-	200	%

<b>SWITCHING CHARACTERISTICS</b> ( $T_{amb} = 25\text{ }^{\circ}\text{C}$ , unless otherwise specified)							
PARAMETER	TEST CONDITION	SYMBOL	MIN.	TYP.	MAX.	UNIT	
Turn on time	$V_{CC} = 5\text{ V}$ , $I_C = 2\text{ mA}$ , $R_L = 100\text{ }\Omega$	$t_{on}$	-	6	-	$\mu\text{s}$	
Rise time	$V_{CC} = 5\text{ V}$ , $I_C = 2\text{ mA}$ , $R_L = 100\text{ }\Omega$	$t_r$	-	3.5	-	$\mu\text{s}$	
Turn off time	$V_{CC} = 5\text{ V}$ , $I_C = 2\text{ mA}$ , $R_L = 100\text{ }\Omega$	$t_{off}$	-	5.5	-	$\mu\text{s}$	
Fall time	$V_{CC} = 5\text{ V}$ , $I_C = 2\text{ mA}$ , $R_L = 100\text{ }\Omega$	$t_f$	-	5	-	$\mu\text{s}$	

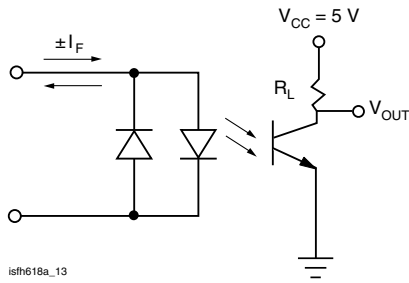

Fig. 2 - Test Circuit

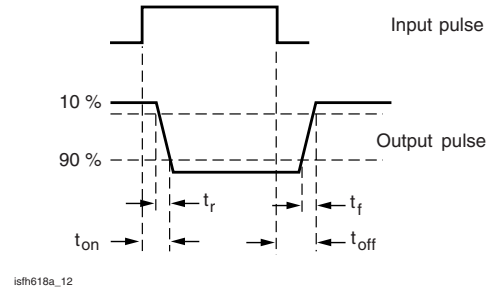

Fig. 3 - Test Circuit and Waveforms

SAFETY AND INSULATION RATINGS				
PARAMETER	TEST CONDITION	SYMBOL	VALUE	UNIT
Climatic classification	According to IEC 68 part 1		55 / 110 / 21	
Pollution degree	According to DIN VDE 0109		2	
Comparative tracking index	Insulation group IIIa	CTI	275	
Maximum rated withstanding isolation voltage	According to UL1577, t = 1 min	V <sub>ISO</sub>	5000	V <sub>RMS</sub>
Maximum transient isolation voltage	According to DIN EN 60747-5-5	V <sub>IOTM</sub>	8000	V <sub>peak</sub>
Maximum repetitive peak isolation voltage	According to DIN EN 60747-5-5	V <sub>IORM</sub>	1050	V <sub>peak</sub>
Isolation resistance	T <sub>amb</sub> = 25 °C, V <sub>IO</sub> = 500 V	R <sub>IO</sub>	≥ 10 <sup>12</sup>	Ω
	T <sub>amb</sub> = 100 °C, V <sub>IO</sub> = 500 V	R <sub>IO</sub>	≥ 10 <sup>11</sup>	Ω
	T <sub>amb</sub> = TS, V <sub>IO</sub> = 500 V	R <sub>IO</sub>	≥ 10 <sup>9</sup>	Ω
Output safety power		P <sub>SO</sub>	265	mW
Input safety current		I <sub>SI</sub>	130	mA
Input safety temperature		T <sub>S</sub>	150	°C
Creepage distance			≥ 8	mm
Clearance distance			≥ 8	mm
Insulation thickness		DTI	≥ 0.4	mm
Input to output test voltage, method B	V <sub>IORM</sub> × 1.875 = V <sub>PR</sub> , 100 % production test with t <sub>M</sub> = 1 s, partial discharge < 5 pC	V <sub>PR</sub>	2000	V <sub>peak</sub>
Input to output test voltage, method A	V <sub>IORM</sub> × 1.6 = V <sub>PR</sub> , 100 % sample test with t <sub>M</sub> = 10 s, partial discharge < 5 pC	V <sub>PR</sub>	1680	V <sub>peak</sub>

**Note**

- According to DIN EN 60747-5-5 (VDE 0884), § 7.4.3.8.2, (see Fig. 4). This optocoupler is suitable for safe electrical isolation only within the safety ratings. Compliance with the safety ratings shall be ensured by means of suitable protective circuits

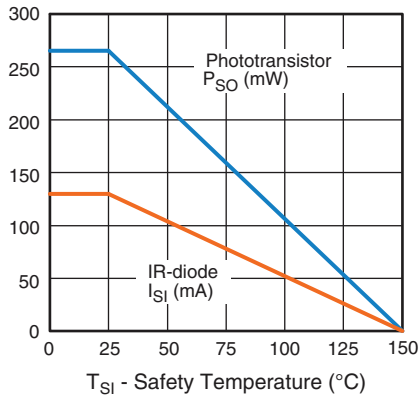

Fig. 4 - Derating Diagram

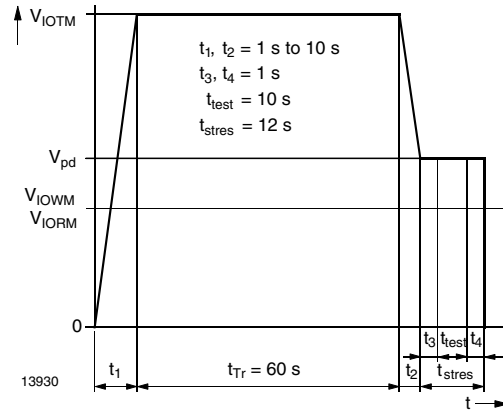

Fig. 5 - Test Pulse Diagram for Sample Test according to DIN EN 60747-5-5

**TYPICAL CHARACTERISTICS** ( $T_{amb} = 25\text{ }^{\circ}\text{C}$ , unless otherwise specified)

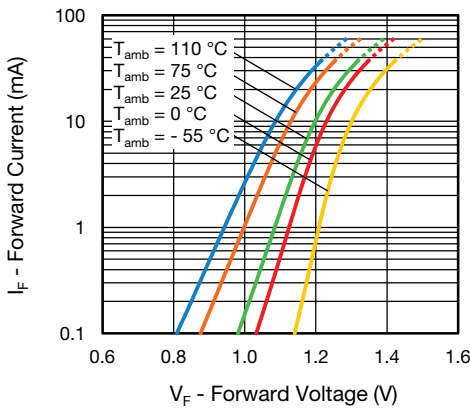

Fig. 6 - Forward Current vs. Forward Voltage

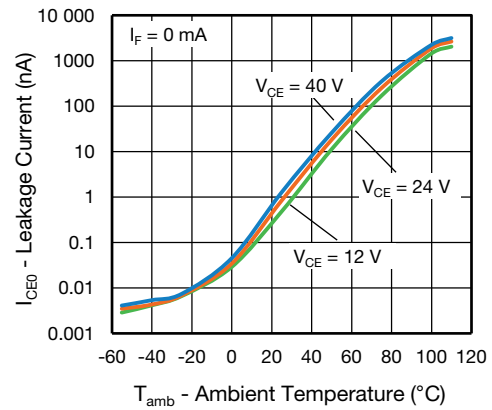

Fig. 8 - Collector Emitter Current vs. Ambient Temperature

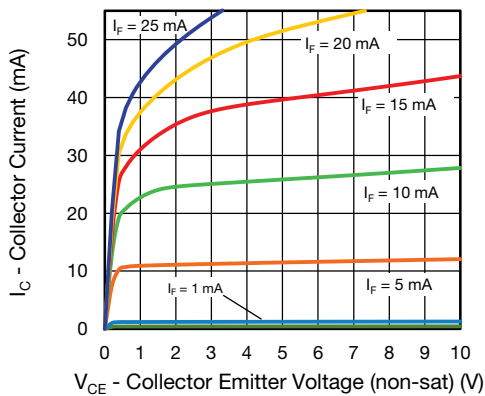

Fig. 7 - Collector Current vs. Collector Emitter Voltage (non-saturated)

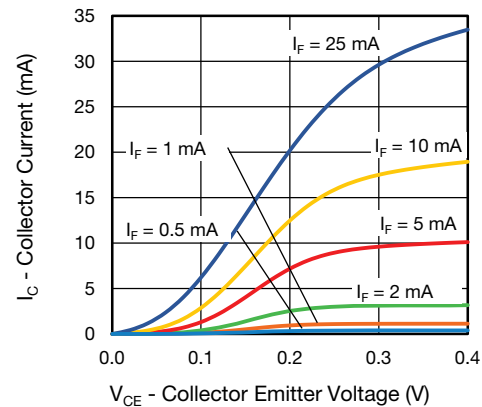

Fig. 9 - Collector Current vs. Collector Emitter Voltage (saturated)

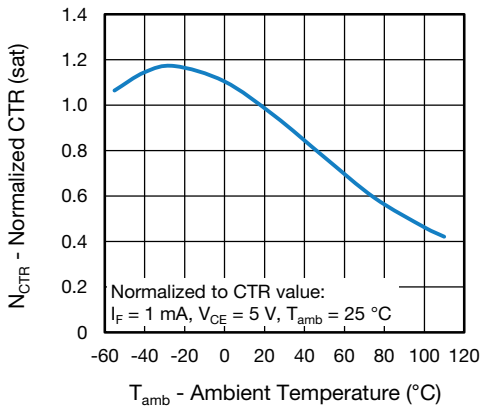

Fig. 10 - Normalized Current Transfer Ratio vs. Ambient Temperature (saturated)

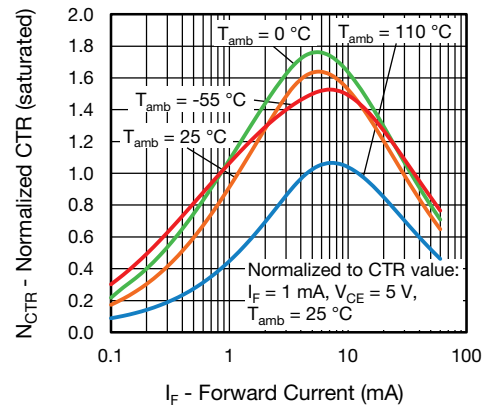

Fig. 13 - Normalized Current Transfer Ratio (saturated) vs. Forward Current

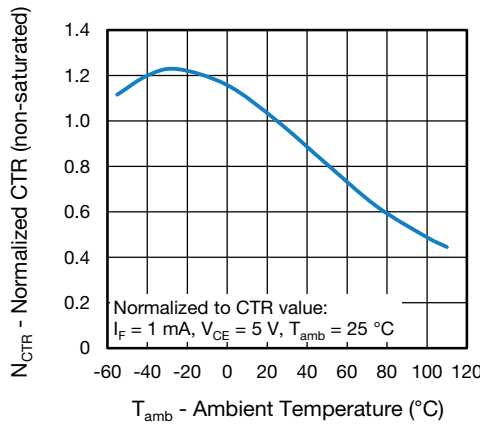

Fig. 11 - Normalized Current Transfer Ratio vs. Ambient Temperature (non-saturated)

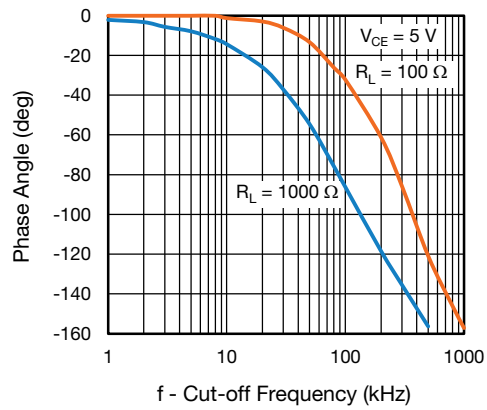

Fig. 14 - Phase Angle vs. Frequency

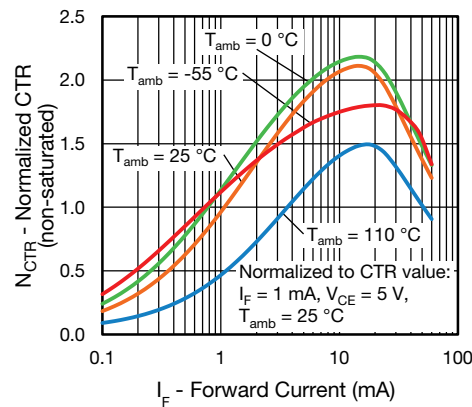

Fig. 12 - Normalized Current Transfer Ratio (non-saturated) vs. Forward Current

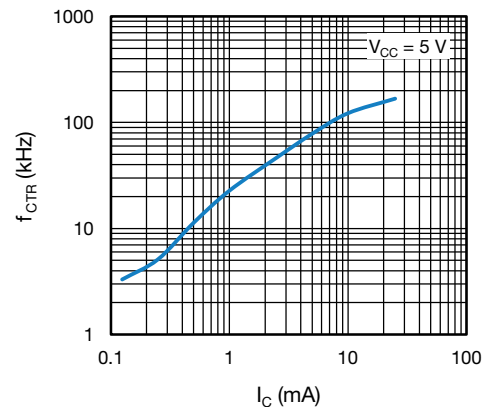

Fig. 15 -  $f_{CTR}$  vs. Collector Current

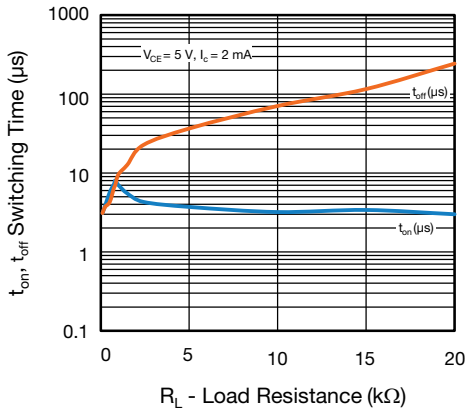

Fig. 16 - Switching Time vs. Load Resistance

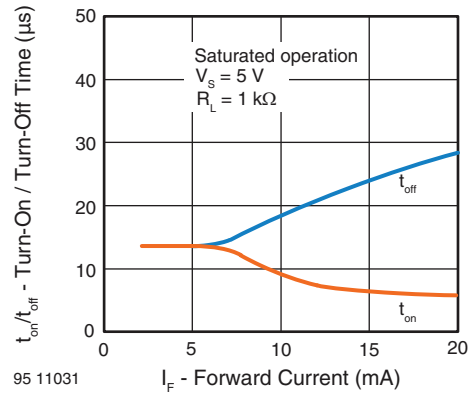

Fig. 18 - Turn-On/Turn-Off Time vs. Forward Current

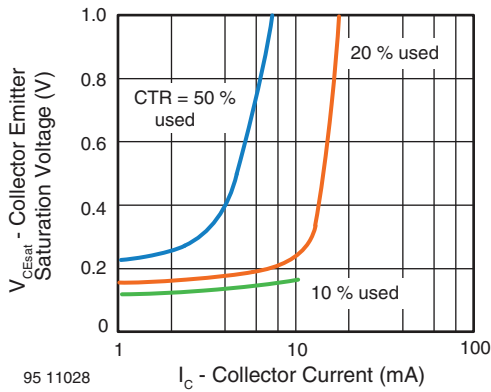

Fig. 17 - Collector Emitter Saturation Voltage vs. Collector Current

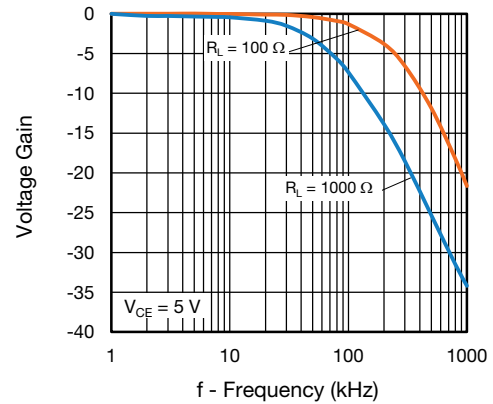
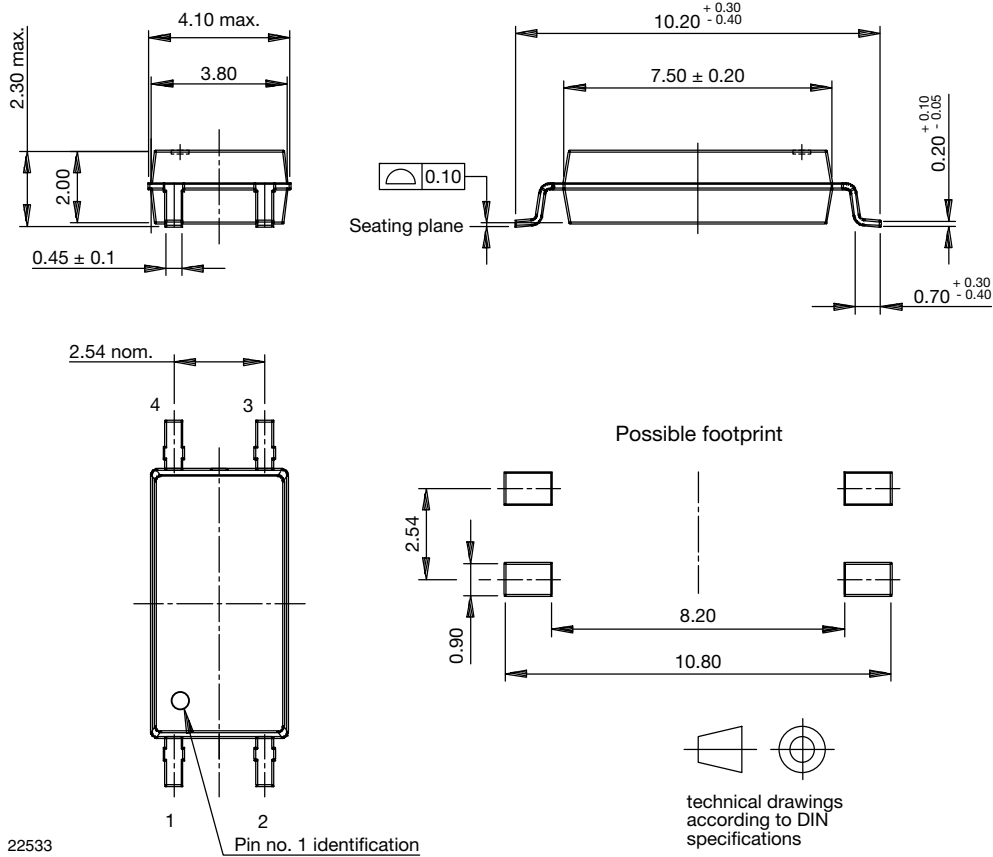
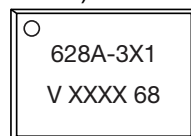

Fig. 19 - Voltage Gain vs. Cut-off Frequency

**PACKAGE DIMENSIONS** (in millimeters)



**PACKAGE MARKING** (example of VOL628A-3X001T)



**Notes**

- Only option 1 is reflected in the package marking with the characters “X1”
- Tape and reel suffix (T) is not part of the package marking
- XXXX = LMC (lot marking code)

**TAPE AND REEL DIMENSIONS** (in millimeters)

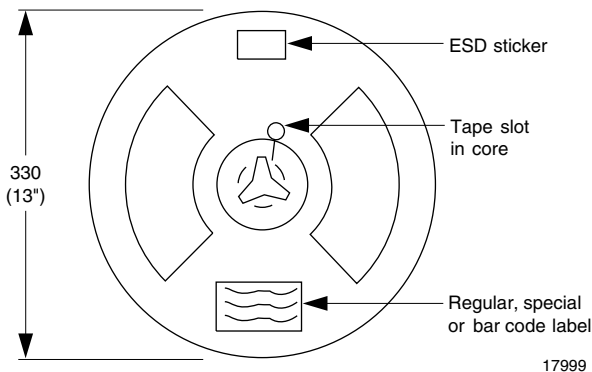

Fig. 20 - Reel Dimensions (3000 units per reel)

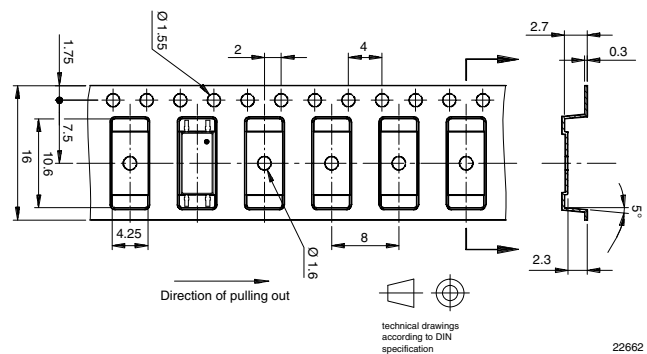
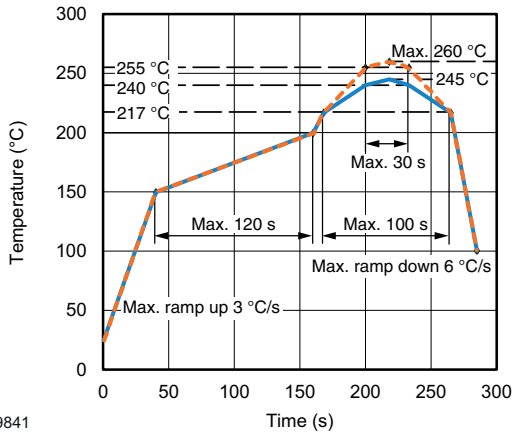

Fig. 21 - Tape Dimensions



**SOLDER PROFILE**



19841

Fig. 22 - Lead (Pb)-free Reflow Solder Profile according to J-STD-020

**HANDLING AND STORAGE CONDITIONS**

ESD level: HBM class 2

Floor life: unlimited

Conditions:  $T_{amb} < 30\text{ °C}$ ,  $RH < 85\%$

Moisture sensitivity level 1, according to J-STD-020



## Disclaimer

ALL PRODUCT, PRODUCT SPECIFICATIONS AND DATA ARE SUBJECT TO CHANGE WITHOUT NOTICE TO IMPROVE RELIABILITY, FUNCTION OR DESIGN OR OTHERWISE.

Vishay Intertechnology, Inc., its affiliates, agents, and employees, and all persons acting on its or their behalf (collectively, "Vishay"), disclaim any and all liability for any errors, inaccuracies or incompleteness contained in any datasheet or in any other disclosure relating to any product.

Vishay makes no warranty, representation or guarantee regarding the suitability of the products for any particular purpose or the continuing production of any product. To the maximum extent permitted by applicable law, Vishay disclaims (i) any and all liability arising out of the application or use of any product, (ii) any and all liability, including without limitation special, consequential or incidental damages, and (iii) any and all implied warranties, including warranties of fitness for particular purpose, non-infringement and merchantability.

Statements regarding the suitability of products for certain types of applications are based on Vishay's knowledge of typical requirements that are often placed on Vishay products in generic applications. Such statements are not binding statements about the suitability of products for a particular application. It is the customer's responsibility to validate that a particular product with the properties described in the product specification is suitable for use in a particular application. Parameters provided in datasheets and / or specifications may vary in different applications and performance may vary over time. All operating parameters, including typical parameters, must be validated for each customer application by the customer's technical experts. Product specifications do not expand or otherwise modify Vishay's terms and conditions of purchase, including but not limited to the warranty expressed therein.

Hyperlinks included in this datasheet may direct users to third-party websites. These links are provided as a convenience and for informational purposes only. Inclusion of these hyperlinks does not constitute an endorsement or an approval by Vishay of any of the products, services or opinions of the corporation, organization or individual associated with the third-party website. Vishay disclaims any and all liability and bears no responsibility for the accuracy, legality or content of the third-party website or for that of subsequent links.

Except as expressly indicated in writing, Vishay products are not designed for use in medical, life-saving, or life-sustaining applications or for any other application in which the failure of the Vishay product could result in personal injury or death. Customers using or selling Vishay products not expressly indicated for use in such applications do so at their own risk. Please contact authorized Vishay personnel to obtain written terms and conditions regarding products designed for such applications.

No license, express or implied, by estoppel or otherwise, to any intellectual property rights is granted by this document or by any conduct of Vishay. Product names and markings noted herein may be trademarks of their respective owners.