

Power SMD LED PLCC-2



19225

DESCRIPTION

The VLM.33.. series is an advanced modification of the Vishay VLM.33.. series. It is designed to incorporate larger chips, therefore, capable of withstanding a 50 mA drive current.

The package of the VLM.33.. is the PLCC-2.

It consists of a lead frame which is embedded in a white thermoplast. The reflector inside this package is filled up with clear epoxy.

PRODUCT GROUP AND PACKAGE DATA

- Product group: LED
- Package: SMD PLCC-2
- Product series: power
- Angle of half intensity: $\pm 60^\circ$

FEATURES

- Utilizing (AS) AlInGaP technology
- Available in 8 mm tape
- Luminous intensity and color categorized per packing unit
- Luminous intensity ratio per packing unit $I_{Vmax.}/I_{Vmin.} \leq 1.6$
- Thermal resistance $R = 400$ K/W
- ESD-withstand voltage: up to 2 kV according to JESD22-A114-B
- Preconditioning according to JEDEC® level 2a
- Compatible with reflow, vapor phase, and wave solder processes according to CECC 00802 and J-STD-020
- AEC-Q101 qualified
- Material categorization: for definitions of compliance please see www.vishay.com/doc?99912

AUTOMOTIVE GRADE


RoHS
 COMPLIANT
 HALOGEN
FREE
GREEN
 (5-2008)

APPLICATIONS

- Traffic signals and signs
- Interior and exterior lighting
- Dashboard illumination
- Indicator and backlighting purposes for audio, video, LCDs switches, symbols, illuminated advertising etc.

PARTS TABLE

| PART | COLOR | LUMINOUS INTENSITY (mcd) | | | at I _F (mA) | WAVELENGTH (nm) | | | at I _F (mA) | FORWARD VOLTAGE (V) | | | at I _F (mA) | TECHNOLOGY |
|-----------------|-----------|--------------------------|------|------|------------------------|-----------------|------|------|------------------------|---------------------|------|------|------------------------|-----------------|
| | | MIN. | TYP. | MAX. | | MIN. | TYP. | MAX. | | MIN. | TYP. | MAX. | | |
| VLMS33S1T2-GS08 | Super red | 180 | 290 | 450 | 30 | 626 | 630 | 638 | 30 | 1.7 | 2.0 | 2.5 | 30 | AllnGaP on GaAs |
| VLMS33S1U1-GS08 | Super red | 180 | 290 | 560 | 30 | 626 | 630 | 638 | 30 | 1.7 | 2.0 | 2.5 | 30 | AllnGaP on GaAs |
| VLMR33T1U2-GS08 | Amber | 280 | 450 | 710 | 30 | 611 | 617 | 622 | 30 | 1.7 | 2.0 | 2.5 | 30 | AllnGaP on GaAs |
| VLMY33T1U2-GS08 | Yellow | 280 | 425 | 710 | 30 | 583 | 588 | 594 | 30 | 1.7 | 2.0 | 2.5 | 30 | AllnGaP on GaAs |
| VLMY33T1U2-GS18 | Yellow | 280 | 425 | 710 | 30 | 583 | 588 | 594 | 30 | 1.7 | 2.0 | 2.5 | 30 | AllnGaP on GaAs |

ABSOLUTE MAXIMUM RATINGS (T_{amb} = 25 °C, unless otherwise specified)

VLM.33..

| PARAMETER | TEST CONDITION | SYMBOL | VALUE | UNIT |
|--|--|-------------------|-------------|------|
| Reverse voltage ⁽¹⁾ | | V _R | 5 | V |
| DC forward current | T _{amb} ≤ 73 °C (400 K/W) | I _F | 50 | mA |
| Power dissipation | | P _V | 130 | mW |
| Junction temperature | | T _j | +125 | °C |
| Operating temperature range | | T _{amb} | -40 to +100 | °C |
| Storage temperature range | | T _{stg} | -40 to +100 | °C |
| Thermal resistance junction to ambient | Mounted on PC board (pad size > 16 mm ²) | R _{thJA} | 400 | K/W |

Note

⁽¹⁾ Driving the LED in reverse direction is suitable for a short term application

**OPTICAL AND ELECTRICAL CHARACTERISTICS** ($T_{amb} = 25\text{ }^{\circ}\text{C}$, unless otherwise specified)
VLMS33.., SUPER RED

| PARAMETER | TEST CONDITION | PART | SYMBOL | MIN. | TYP. | MAX. | UNIT |
|--|----------------------|------------|-----------------|------|----------|------|---------------|
| Luminous intensity | $I_F = 30\text{ mA}$ | VLMS33S1T2 | I_V | 180 | 290 | 450 | mcd |
| | | VLMS33S1U1 | I_V | 180 | 290 | 560 | mcd |
| Luminous flux/luminous intensity | | | ϕ_V/I_V | - | 3 | - | mlm/mcd |
| Dominant wavelength | $I_F = 30\text{ mA}$ | | λ_d | 626 | 630 | 638 | nm |
| Peak wavelength | $I_F = 30\text{ mA}$ | | λ_p | - | 641 | - | nm |
| Spectral bandwidth at 50 % $I_{rel\ max.}$ | $I_F = 30\text{ mA}$ | | $\Delta\lambda$ | - | 17 | - | nm |
| Angle of half intensity | $I_F = 30\text{ mA}$ | | ϕ | - | ± 60 | - | $^{\circ}$ |
| Forward voltage | $I_F = 30\text{ mA}$ | | V_F | 1.7 | 2.0 | 2.5 | V |
| Reverse current | $V_R = 5\text{ V}$ | | I_R | - | 0.01 | 10 | μA |

OPTICAL AND ELECTRICAL CHARACTERISTICS ($T_{amb} = 25\text{ }^{\circ}\text{C}$, unless otherwise specified)
VLMR33.., AMBER

| PARAMETER | TEST CONDITION | PART | SYMBOL | MIN. | TYP. | MAX. | UNIT |
|--|----------------------|------------|-----------------|------|----------|------|---------------|
| Luminous intensity | $I_F = 30\text{ mA}$ | VLMR33T1U2 | I_V | 280 | 450 | 710 | mcd |
| Luminous flux/luminous intensity | | | ϕ_V/I_V | - | 3 | - | mlm/mcd |
| Dominant wavelength | $I_F = 30\text{ mA}$ | | λ_d | 611 | 617 | 622 | nm |
| Peak wavelength | $I_F = 30\text{ mA}$ | | λ_p | - | 624 | - | nm |
| Spectral bandwidth at 50 % $I_{rel\ max.}$ | $I_F = 30\text{ mA}$ | | $\Delta\lambda$ | - | 18 | - | nm |
| Angle of half intensity | $I_F = 30\text{ mA}$ | | ϕ | - | ± 60 | - | $^{\circ}$ |
| Forward voltage | $I_F = 30\text{ mA}$ | | V_F | 1.7 | 2.0 | 2.5 | V |
| Reverse current | $V_R = 5\text{ V}$ | | I_R | - | 0.01 | 10 | μA |

OPTICAL AND ELECTRICAL CHARACTERISTICS ($T_{amb} = 25\text{ }^{\circ}\text{C}$, unless otherwise specified)
VLMY33T1U2, YELLOW

| PARAMETER | TEST CONDITION | PART | SYMBOL | MIN. | TYP. | MAX. | UNIT |
|--|----------------------|------------|-----------------|------|----------|------|---------------|
| Luminous intensity | $I_F = 30\text{ mA}$ | VLMY33T1U2 | I_V | 280 | 425 | 710 | mcd |
| Luminous flux/luminous intensity | | | ϕ_V/I_V | - | 3 | - | mlm/mcd |
| Dominant wavelength | $I_F = 30\text{ mA}$ | VLMY33T1U2 | λ_d | 583 | 588 | 594 | nm |
| Peak wavelength | $I_F = 30\text{ mA}$ | | λ_p | - | 590 | - | nm |
| Spectral bandwidth at 50 % $I_{rel\ max.}$ | $I_F = 30\text{ mA}$ | | $\Delta\lambda$ | - | 18 | - | nm |
| Angle of half intensity | $I_F = 30\text{ mA}$ | | ϕ | - | ± 60 | - | $^{\circ}$ |
| Forward voltage | $I_F = 30\text{ mA}$ | | V_F | 1.7 | 2.0 | 2.5 | V |
| Reverse current | $V_R = 5\text{ V}$ | | I_R | - | 0.01 | 10 | μA |

COLOR CLASSIFICATION

| GROUP | DOMINANT WAVELENGTH (nm) | | | |
|-------|--------------------------|------|--------|------|
| | AMBER | | YELLOW | |
| | MIN. | MAX. | MIN. | MAX. |
| 1 | 611 | 618 | 581 | 584 |
| 2 | 614 | 622 | 583 | 586 |
| 3 | - | - | 585 | 588 |
| 4 | - | - | 587 | 590 |
| 5 | - | - | 589 | 592 |
| 6 | - | - | 591 | 594 |

Note

- Wavelengths are tested at a current pulse duration of 25 ms

| LUMINOUS INTENSITY CLASSIFICATION | | | |
|-----------------------------------|--------------------------|------|------|
| GROUP | LUMINOUS INTENSITY (mcd) | | |
| STANDARD | OPTIONAL | MIN. | MAX. |
| P | 1 | 45 | 56 |
| | 2 | 56 | 71 |
| Q | 1 | 71 | 90 |
| | 2 | 90 | 112 |
| R | 1 | 112 | 140 |
| | 2 | 140 | 180 |
| S | 1 | 180 | 224 |
| | 2 | 224 | 280 |
| T | 1 | 280 | 355 |
| | 2 | 355 | 450 |
| U | 1 | 450 | 560 |
| | 2 | 560 | 710 |

| CROSSING TABLE | |
|----------------|-------------|
| VISHAY | OSRAM |
| VLMS33S1T2 | LST67B-S1T2 |
| VLMS33S1U1 | LST67B-T1U1 |

Note

- Luminous intensity is tested at a current pulse duration of 25 ms and an accuracy of $\pm 11\%$.
The above type Numbers represent the order groups which include only a few brightness groups. Only one group will be shipped on each reel (there will be no mixing of two groups on each reel).
In order to ensure availability, single brightness groups will not be orderable.
In a similar manner for colors where wavelength groups are measured and binned, single wavelength groups will be shipped on any one reel.
In order to ensure availability, single wavelength groups will not be orderable

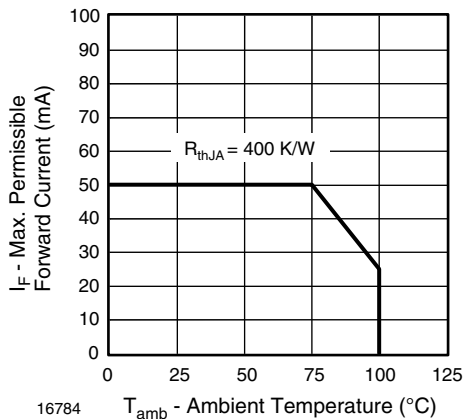
TYPICAL CHARACTERISTICS ($T_{amb} = 25\text{ }^{\circ}\text{C}$, unless otherwise specified)


Fig. 1 - Forward Current vs. Ambient Temperature

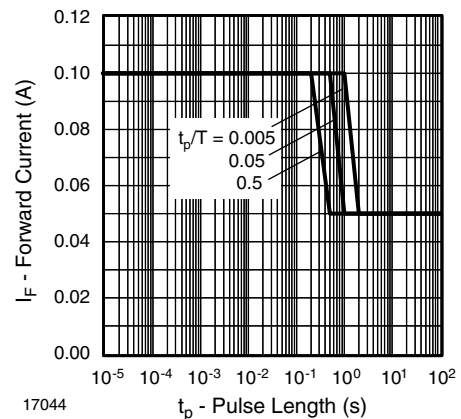


Fig. 2 - Forward Current vs. Pulse Length

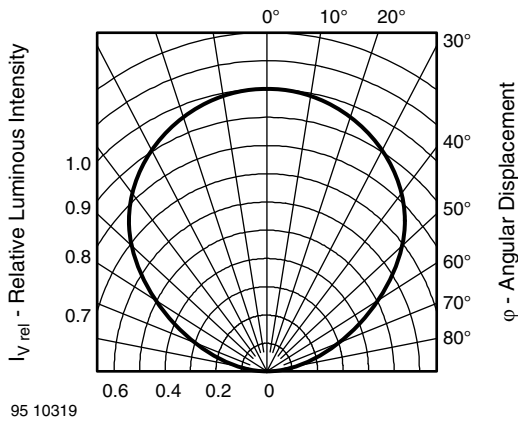


Fig. 3 - Relative Luminous Intensity vs. Angular Displacement

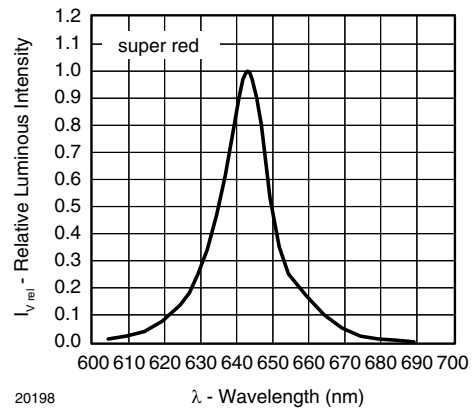


Fig. 6 - Relative Intensity vs. Wavelength

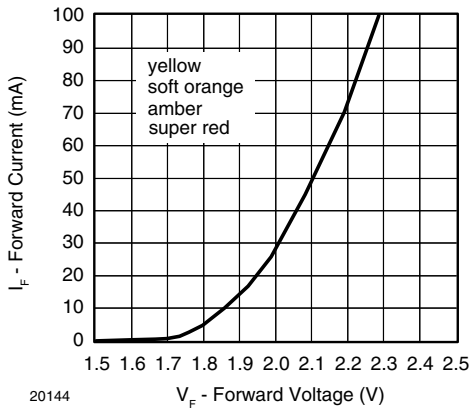


Fig. 4 - Forward Current vs. Forward Voltage

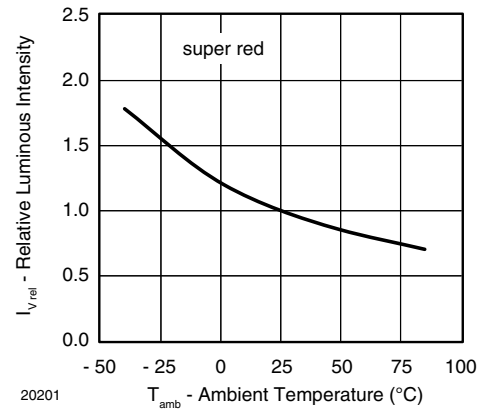


Fig. 7 - Relative Luminous Intensity vs. Ambient Temperature

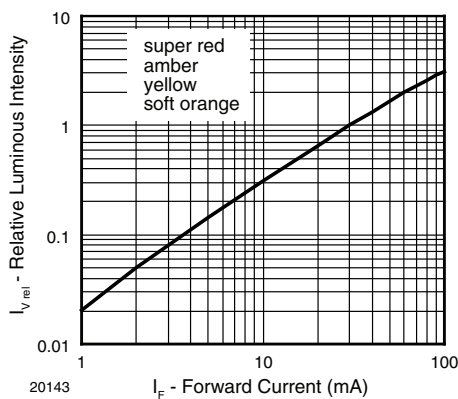


Fig. 5 - Relative Luminous Intensity vs. Forward Current

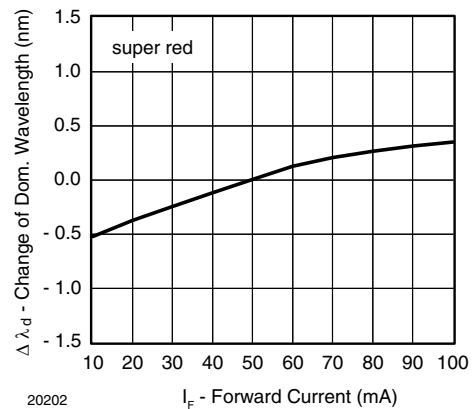


Fig. 8 - Change of Dominant Wavelength vs. Forward Current

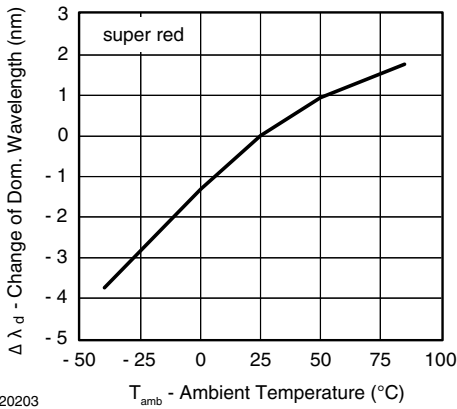


Fig. 9 - Change of Dominant Wavelength vs. Ambient Temperature

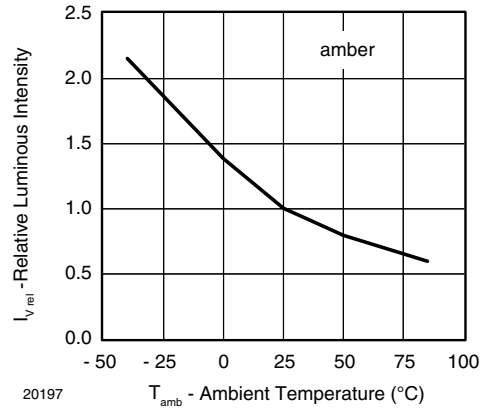


Fig. 12 - Relative Luminous Intensity vs. Ambient Temperature

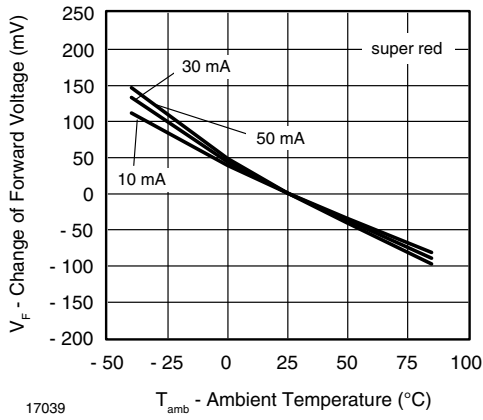


Fig. 10 - Change of Forward Voltage vs. Ambient Temperature

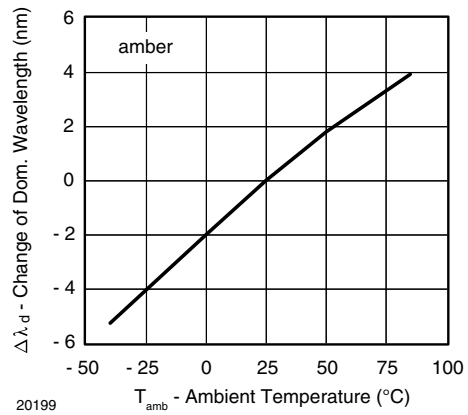


Fig. 13 - Change of Dominant Wavelength vs. Ambient Temperature

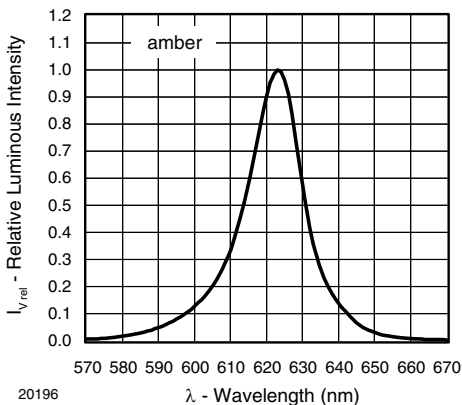


Fig. 11 - Relative Intensity vs. Wavelength

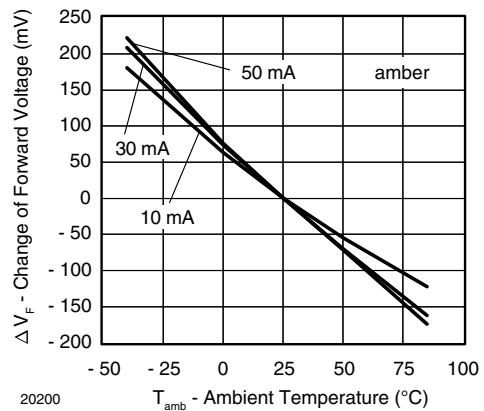


Fig. 14 - Change of Forward Voltage vs. Ambient Temperature

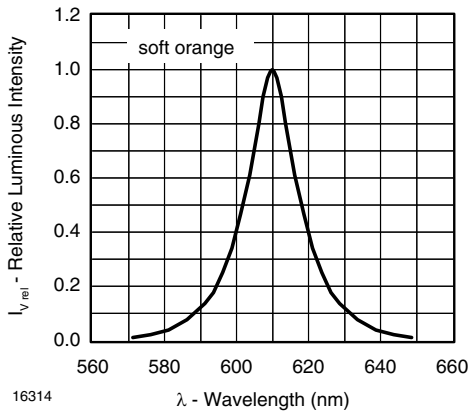


Fig. 15 - Relative Intensity vs. Wavelength

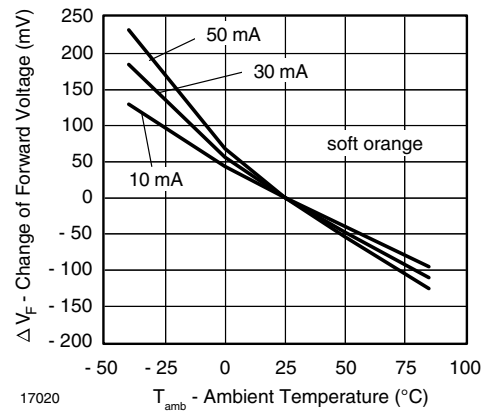


Fig. 18 - Change of Forward Voltage vs. Ambient Temperature

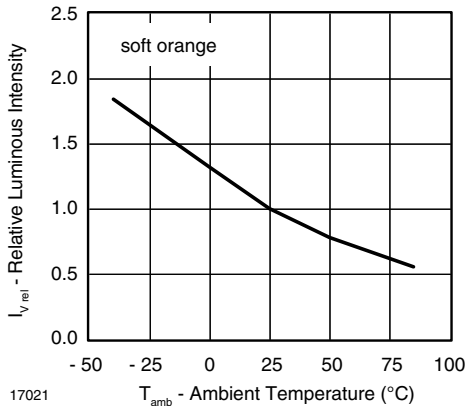


Fig. 16 - Relative Luminous Intensity vs. Ambient Temperature

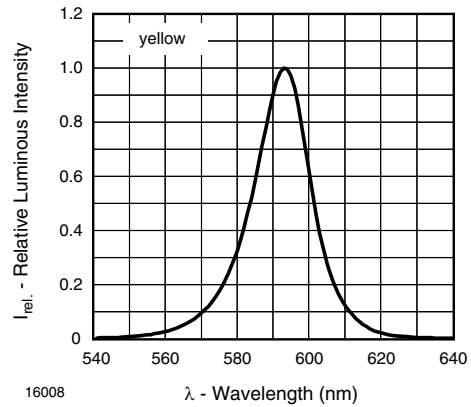


Fig. 19 - Relative Intensity vs. Wavelength

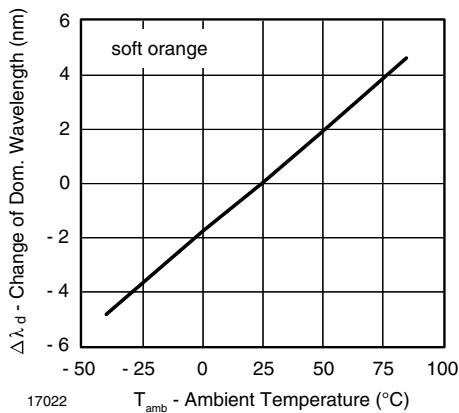


Fig. 17 - Change of Dominant Wavelength vs. Ambient Temperature

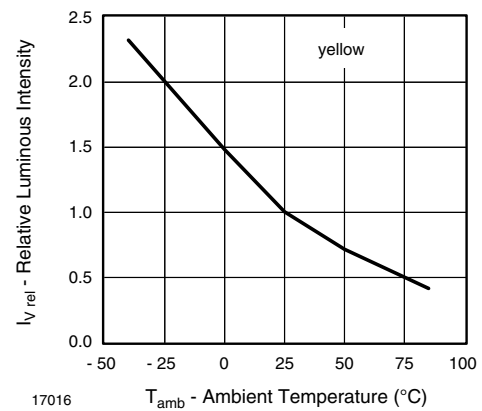


Fig. 20 - Relative Luminous Intensity vs. Ambient Temperature

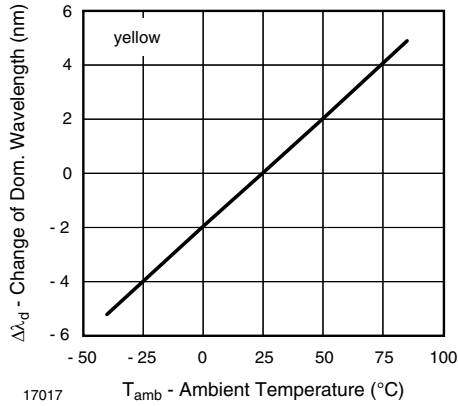


Fig. 21 - Change of Dominant Wavelength vs. Ambient Temperature

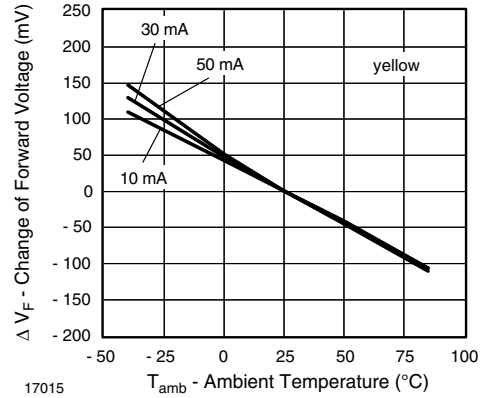
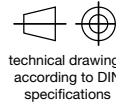
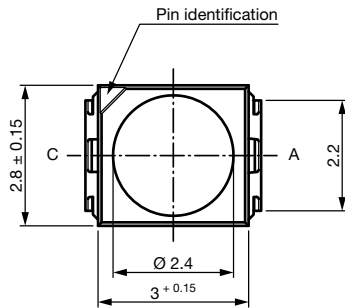
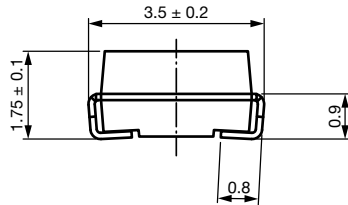
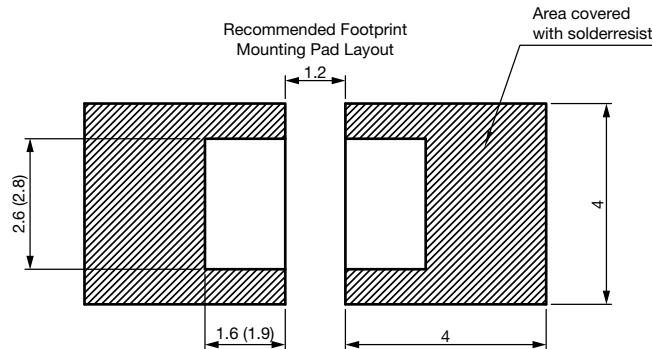


Fig. 22 - Change of Forward Voltage vs. Ambient Temperature

PACKAGE DIMENSIONS in millimeters



Drawing-No.: 6.541-5067.01-4
Issue: 7; 12.03.14



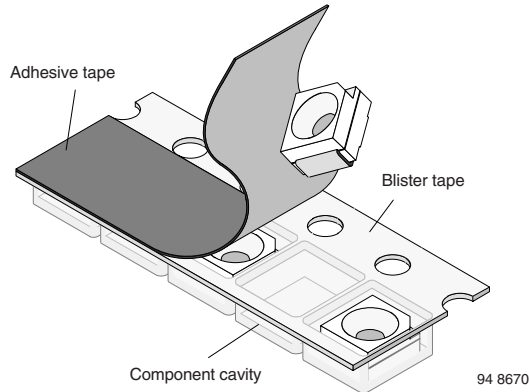
| PACKING INFORMATION | | | |
|---------------------|-----------------|---------------|--------------------|
| PART | PIECES PER REEL | REELS PER BOX | MOQ ⁽¹⁾ |
| VLMx33xx-GS08 | 1500 | 5 | 7500 |
| VLMx33xx-GS18 | 8000 | 1 | 8000 |

Note
⁽¹⁾ MOQ = minimum order quantity

METHOD OF TAPING / POLARITY AND TAPE AND REEL

SMD LED (VLM3-SERIES)

Vishay's LEDs in SMD packages are available in an antistatic 8 mm blister tape (in accordance with DIN IEC 40 (CO) 564) for automatic component insertion. The blister tape is a plastic strip with impressed component cavities, covered by a top tape.



REEL PACKAGE DIMENSION IN MILLIMETERS FOR SMD LEDs, TAPE OPTION GS18 (= 8000 PCS) PREFERRED

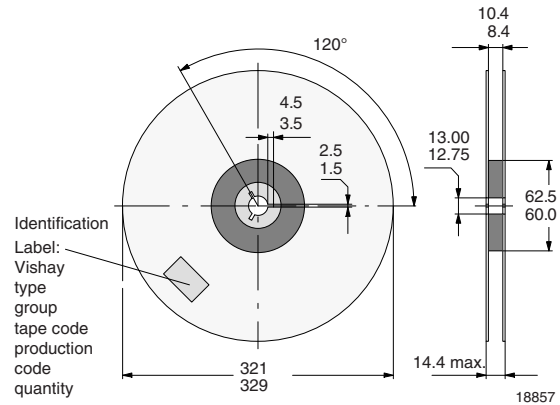


Fig. 25 - Reel Dimensions - GS18

TAPING OF VLM.3..

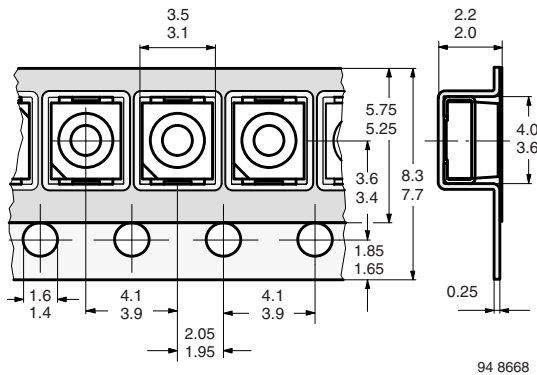


Fig. 23 - Tape Dimensions in mm for PLCC-2

SOLDERING PROFILE

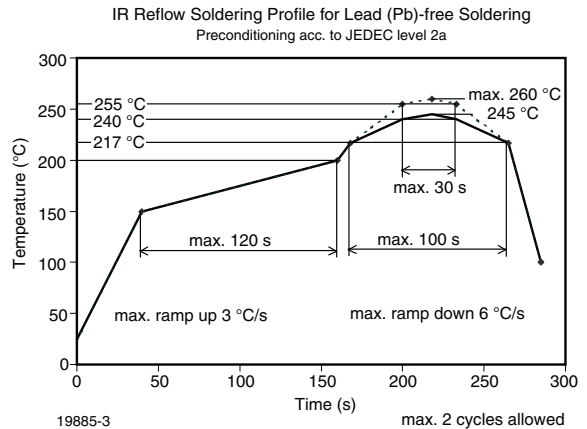


Fig. 26 - Vishay Lead (Pb)-free Reflow Soldering Profile (according to J-STD-020)

REEL PACKAGE DIMENSION IN MILLIMETERS FOR SMD LEDs, TAPE OPTION GS08 (= 1500 PCS)

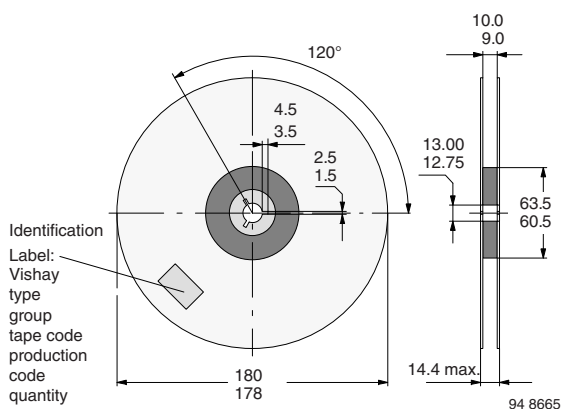


Fig. 24 - Reel Dimensions - GS08

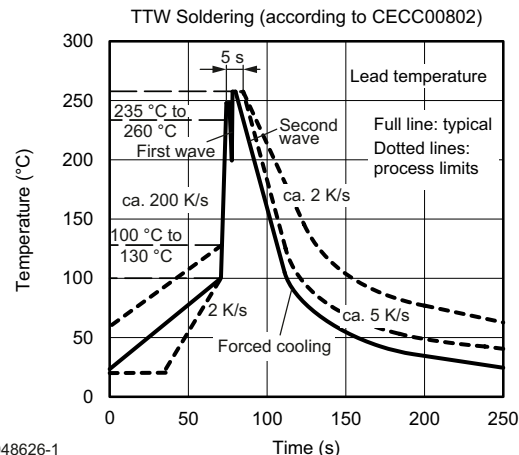
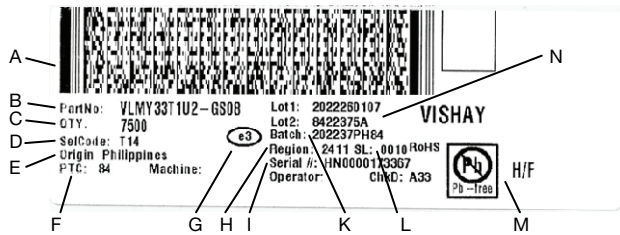


Fig. 27 - Double Wave Soldering of Opto Devices (all packages)

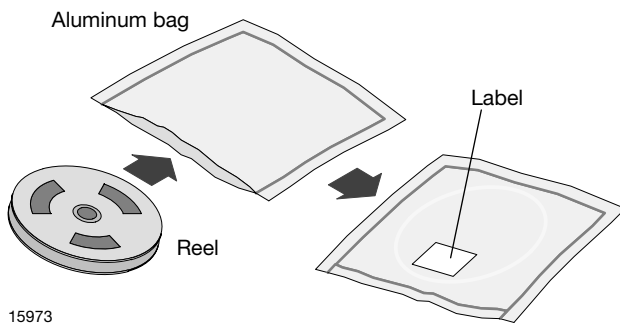
BAR CODE PRODUCT LABEL (example)



- A. 2D barcode
- B. Part No: Vishay part number
- C. QTY: quantity
- D. SelCode: selection bin code
- E. Country of origin
- F. PTC: production plant code
- G. Termination finish
- H. Region code
- I. Serial#: serial number
- K. Batch number: year, week, country code, plant code
- L. SL: storage location
- M. Environmental symbols: RoHS, lead (Pb)-free, halogen-free
- N. Lot numbers

DRY PACKING

The reel is packed in an anti-humidity bag to protect the devices from absorbing moisture during transportation and storage.



FINAL PACKING

The sealed reel is packed into a cardboard box. A secondary cardboard box is used for shipping purposes.

RECOMMENDED METHOD OF STORAGE

Dry box storage is recommended as soon as the aluminum bag has been opened to prevent moisture absorption. The following conditions should be observed, if dry boxes are not available:

- Storage temperature 10 °C to 30 °C
- Storage humidity ≤ 60 % RH max.

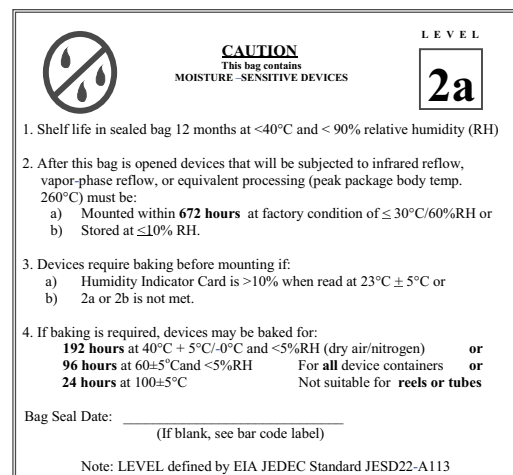
After more than 672 h under these conditions moisture content will be too high for reflow soldering.

In case of moisture absorption, the devices will recover to the former condition by drying under the following condition: 192 h at 40 °C + 5 °C / - 0 °C and < 5 % RH (dry air / nitrogen) or

96 h at 60 °C + 5 °C and < 5 % RH for all device containers or

24 h at 100 °C + 5 °C not suitable for reel or tubes.

An EIA JEDEC standard JESD22-A112 level 2a label is included on all dry bags.



Example of JESD22-A112 level 2a label

ESD PRECAUTION

Proper storage and handling procedures should be followed to prevent ESD damage to the devices especially when they are removed from the antistatic shielding bag. Electrostatic sensitive devices warning labels are on the packaging.

VISHAY SEMICONDUCTORS STANDARD BAR CODE LABELS

The Vishay Semiconductors standard bar code labels are printed at final packing areas. The labels are on each packing unit and contain Vishay Semiconductors specific data.



Disclaimer

ALL PRODUCT, PRODUCT SPECIFICATIONS AND DATA ARE SUBJECT TO CHANGE WITHOUT NOTICE TO IMPROVE RELIABILITY, FUNCTION OR DESIGN OR OTHERWISE.

Vishay Intertechnology, Inc., its affiliates, agents, and employees, and all persons acting on its or their behalf (collectively, "Vishay"), disclaim any and all liability for any errors, inaccuracies or incompleteness contained in any datasheet or in any other disclosure relating to any product.

Vishay makes no warranty, representation or guarantee regarding the suitability of the products for any particular purpose or the continuing production of any product. To the maximum extent permitted by applicable law, Vishay disclaims (i) any and all liability arising out of the application or use of any product, (ii) any and all liability, including without limitation special, consequential or incidental damages, and (iii) any and all implied warranties, including warranties of fitness for particular purpose, non-infringement and merchantability.

Statements regarding the suitability of products for certain types of applications are based on Vishay's knowledge of typical requirements that are often placed on Vishay products in generic applications. Such statements are not binding statements about the suitability of products for a particular application. It is the customer's responsibility to validate that a particular product with the properties described in the product specification is suitable for use in a particular application. Parameters provided in datasheets and / or specifications may vary in different applications and performance may vary over time. All operating parameters, including typical parameters, must be validated for each customer application by the customer's technical experts. Product specifications do not expand or otherwise modify Vishay's terms and conditions of purchase, including but not limited to the warranty expressed therein.

Hyperlinks included in this datasheet may direct users to third-party websites. These links are provided as a convenience and for informational purposes only. Inclusion of these hyperlinks does not constitute an endorsement or an approval by Vishay of any of the products, services or opinions of the corporation, organization or individual associated with the third-party website. Vishay disclaims any and all liability and bears no responsibility for the accuracy, legality or content of the third-party website or for that of subsequent links.

Except as expressly indicated in writing, Vishay products are not designed for use in medical, life-saving, or life-sustaining applications or for any other application in which the failure of the Vishay product could result in personal injury or death. Customers using or selling Vishay products not expressly indicated for use in such applications do so at their own risk. Please contact authorized Vishay personnel to obtain written terms and conditions regarding products designed for such applications.

No license, express or implied, by estoppel or otherwise, to any intellectual property rights is granted by this document or by any conduct of Vishay. Product names and markings noted herein may be trademarks of their respective owners.