

SERIES: VGDS2-SIP | **DESCRIPTION:** DC-DC CONVERTER

FEATURES

- 2 W isolated output
- industry standard 7 pin SIP package
- dual unregulated outputs
- 6,000 Vdc isolation
- short circuit protection
- wide temperature (-40~105°C)
- efficiency up to 84%

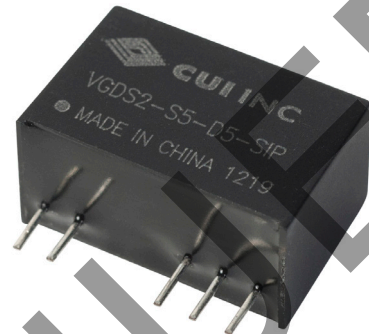

MODEL	input voltage		output voltage (Vdc)	output current		output power max (W)	ripple and noise ¹ max (mVp-p)	efficiency typ (%)
	typ (Vdc)	range (Vdc)		min (mA)	max (mA)			
VGDS2-S5-D5-SIP	5	4.5~5.5	±5	±20	±200	2	250	76
VGDS2-S5-D9-SIP	5	4.5~5.5	±9	±12	±111	2	250	78
VGDS2-S5-D12-SIP	5	4.5~5.5	±12	±9	±83	2	250	77
VGDS2-S5-D15-SIP	5	4.5~5.5	±15	±7	±67	2	250	78
VGDS2-S12-D5-SIP	12	10.8~13.2	±5	±20	±200	2	250	80
VGDS2-S12-D9-SIP	12	10.8~13.2	±9	±12	±111	2	250	84
VGDS2-S12-D12-SIP	12	10.8~13.2	±12	±9	±83	2	250	81
VGDS2-S12-D15-SIP	12	10.8~13.2	±15	±7	±67	2	250	84
VGDS2-S24-D5-SIP	24	21.6~26.4	±5	±20	±200	2	250	80
VGDS2-S24-D9-SIP	24	21.6~26.4	±9	±12	±111	2	250	77
VGDS2-S24-D12-SIP	24	21.6~26.4	±12	±9	±83	2	250	81
VGDS2-S24-D15-SIP	24	21.6~26.4	±15	±7	±67	2	250	82

Notes: 1. ripple and noise are measured at 20 MHz BW by "parallel cable" method with 1 μ F ceramic and 10 μ F electrolytic capacitors on the output.

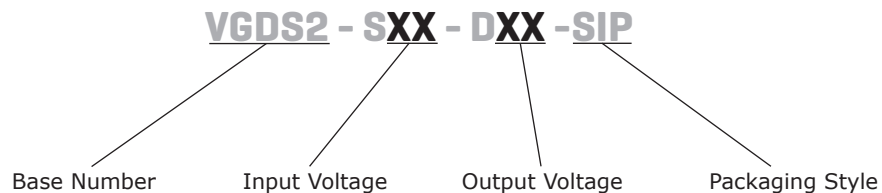
PART NUMBER KEY

INPUT

parameter	conditions/description	min	typ	max	units
operating input voltage	5 Vdc input models	4.5	5	5.5	Vdc
	12 Vdc input models	10.8	12	13.2	Vdc
	24 Vdc input models	21.6	24	26.4	Vdc
surge voltage	for maximum of 1 second				
	5 Vdc input models	-0.7		9	Vdc
	12 Vdc input models	-0.7		18	Vdc
	24 Vdc input models	-0.7		30	Vdc
filter	capacitance filter				

OUTPUT

parameter	conditions/description	min	typ	max	units
line regulation	for Vin change of 1%			±1.2	%
load regulation	measured from 10% load to full load			15	%
voltage accuracy	see derating curves				
voltage balance ¹	dual output, balanced loads	±0.5	±1		%
switching frequency	5Vdc input models		60		kHz
	12Vdc input models		80		kHz
	24Vdc input models		80		kHz
temperature coefficient	100% load, typical input		±0.03		%/°C

Notes: 1. Unbalanced loads should not exceed ±5%. If ±5% is exceeded, it may not meet all specifications.

PROTECTIONS

parameter	conditions/description	min	typ	max	units
short circuit protection	continuous				

SAFETY AND COMPLIANCE

parameter	conditions/description	min	typ	max	units
isolation voltage	for 1 minute at 1 mA max.	6,000			Vdc
isolation resistance	at 500 Vdc	1,000			MΩ
MTBF	as per MIL-HDBK-217F @ 25°C	3,500,000			hours
RoHS	2011/65/EU				

ENVIRONMENTAL

parameter	conditions/description	min	typ	max	units
operating temperature	see derating curve	-40		105	°C
storage temperature		-55		125	°C
storage humidity	non-condensing			95	%
temperature rise	at full load		25		°C
lead temperature	1.5 mm from case for 10 seconds			300	°C

DERATING CURVES

1. output power vs. ambient temperature

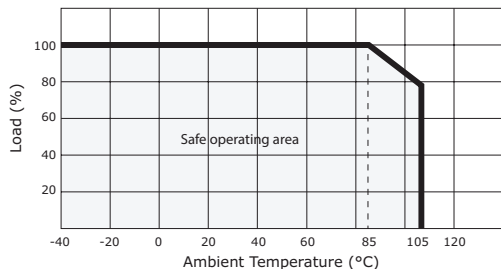

2. output voltage vs. output current

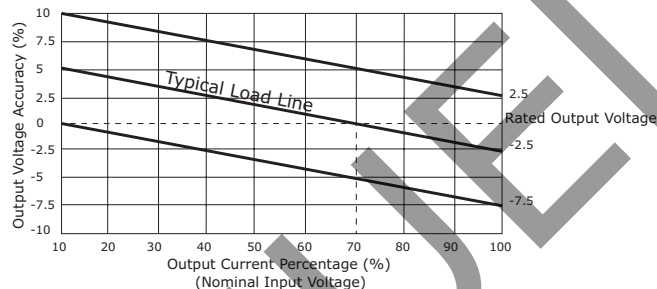

MECHANICAL

parameter	conditions/description	min	typ	max	units
dimensions	19.5 x 9.80 x 12.5 (0.768 x 0.386 x 0.492 inch)				mm
case material	plastic (UL94-V0)				
weight			4.2		g

MECHANICAL DRAWING

units: mm[inch]
 tolerance: ±0.25mm[±0.01 inch]
 pin section tolerance: ±0.10mm[±0.004 inch]

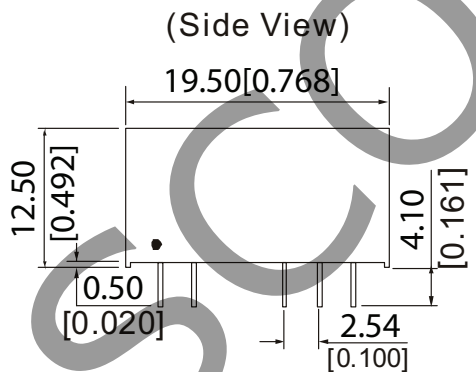

(Bottom View)

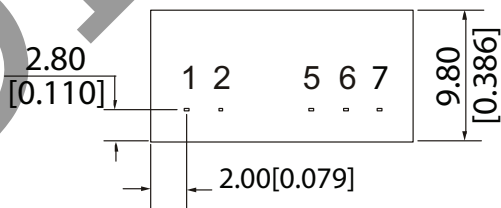

First Angle Projection

RECOMMENDED FOOTPRINT
 Top view, grid: 2.54mm (0.1inch)
 diameter: 1.00mm (0.039inch)

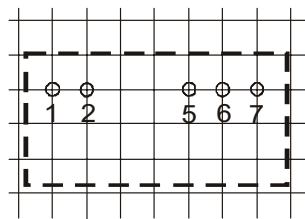

PIN CONNECTIONS	
PIN	FUNCTION
1	+Vin
2	GND
5	-Vo
6	0V
7	+Vo

APPLICATION NOTES

1. Requirement on output load

To ensure that this module can operate efficiently and reliably, a minimum load is specified in addition to a maximum load. During operation, make sure that the specified range of input voltage is not exceeded and that the minimum output load is not less than 10% of the full load. This product should never be operated under no load. If the output of the power supply is small, please connect a resistor with proper resistance at the output end in parallel to increase the load.

2. Recommended testing and application circuit

If you want to further decrease the input/output ripple, an "LC" filtering network can be connected as per Figure 1.

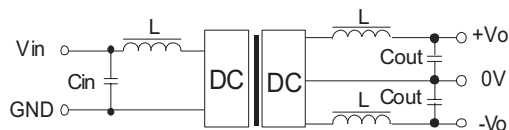

Figure 1

It should also be noted that the inductance and the frequency of the "LC" filtering network should be staggered with the dc-dc frequency to avoid mutual interference. However, the capacitance of the output filter capacitor must be correct. If the capacitance is too large then a startup problem may arise. The maximum capacitance for each output is 100 μF . For every channel of output, provided that safe and reliable operation is ensured, the recommended capacitance of its filter capacitor should be what is shown in Table 1.

Table 1

Vin (Vdc)	Cin (μF)	Dual Vout (Vdc)	Cout (μF)
5	10	± 5	4.7
12	4.7	± 9	2.2
--	--	± 12	1.0
24	2.2	$\pm 15/ \pm 24$	0.47

It is not recommended to connect any external capacitor in the application field with less than a 0.5 W output.

3. Output voltage regulation and over-voltage protection circuit

The simplest device for output voltage regulation, over-voltage and over-current protection is a linear voltage regulator with overheat protection that is connected to the output end in series. (Figure 2)

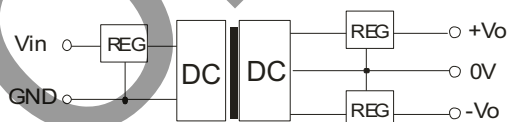

Figure 2

4. Overload protection

Under normal operating conditions, the output circuit of these dc-dc converters has no protection against overload. The simplest method is to connect a self-recovery fuse in series at the input end or add a circuit breaker to the circuit.

- Note:
1. Operation under minimum load will not damage the converter; however, they may not meet all specifications listed.
 2. Max. capacitive load tested at input voltage range and full load.
 3. All specifications measured at: $T_a=25^\circ\text{C}$, humidity<75%, nominal input voltage and rated output load, unless otherwise specified.

REVISION HISTORY

rev.	description	date
1.0	initial release	06/20/2006
1.01	new template applied, V-Infinity branding removed	09/10/2012
1.02	updated datasheet	09/05/2014

The revision history provided is for informational purposes only and is believed to be accurate.



Headquarters
20050 SW 112th Ave.
Tualatin, OR 97062
800.275.4899

Fax 503.612.2383
cui.com
techsupport@cui.com

CUI offers a two (2) year limited warranty. Complete warranty information is listed on our website.

CUI reserves the right to make changes to the product at any time without notice. Information provided by CUI is believed to be accurate and reliable. However, no responsibility is assumed by CUI for its use, nor for any infringements of patents or other rights of third parties which may result from its use.

CUI products are not authorized or warranted for use as critical components in equipment that requires an extremely high level of reliability. A critical component is any component of a life support device or system whose failure to perform can be reasonably expected to cause the failure of the life support device or system, or to affect its safety or effectiveness.