

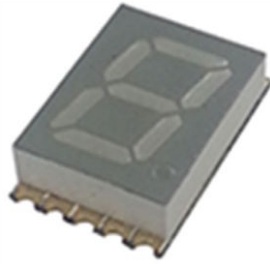

## Standard 7-Segment SMD Display 10 mm



### DESCRIPTION

The VDM.10.0 series are 10 mm SMD seven segment LED displays in a very compact package.

The devices utilize AllnGaP on GaAs chip technology.

### PRODUCT GROUP AND PACKAGE DATA

- Product group: Display
- Package: 10 mm
- Product series: SMD
- Angle of half intensity:  $\pm 50^\circ$

### FEATURES

- Evenly lighted segments
- Grey package surface
- Untinted segments
- Luminous intensity categorized
- Yellow, green, and soft orange categorized for color
- Wide viewing angle
- Suitable for DC and high peak current
- Material categorization: For definitions of compliance please see [www.vishay.com/doc?99912](http://www.vishay.com/doc?99912)



RoHS COMPLIANT

### APPLICATIONS

- Panel meters
- Test- and measure-equipment
- Point-of-sale terminals
- Control units

| PARTS TABLE |             |                                       |      |      |               |                 |      |      |               |                     |      |      |               |                |
|-------------|-------------|---------------------------------------|------|------|---------------|-----------------|------|------|---------------|---------------------|------|------|---------------|----------------|
| PART        | COLOR       | LUMINOUS INTENSITY ( $\mu\text{cd}$ ) |      |      | at $I_F$ (mA) | WAVELENGTH (nm) |      |      | at $I_F$ (mA) | FORWARD VOLTAGE (V) |      |      | at $I_F$ (mA) | CIRCUITRY      |
|             |             | MIN.                                  | TYP. | MAX. |               | MIN.            | TYP. | MAX. |               | MIN.                | TYP. | MAX. |               |                |
| VDMR10A0    | Super red   | 180                                   | 650  | -    | 1             | -               | 631  | -    | 20            | -                   | 2.0  | 2.6  | 20            | Common anode   |
| VDMR10C0    | Super red   | 180                                   | 650  | -    | 1             | -               | 631  | -    | 20            | -                   | 2.0  | 2.6  | 20            | Common cathode |
| VDMO10A0    | Soft orange | 180                                   | 650  | -    | 1             | -               | 605  | -    | 20            | -                   | 2.0  | 2.6  | 20            | Common anode   |
| VDMO10C0    | Soft orange | 180                                   | 650  | -    | 1             | -               | 605  | -    | 20            | -                   | 2.0  | 2.6  | 20            | Common cathode |
| VDMY10A0    | Yellow      | 1100                                  | 2750 | -    | 1             | -               | 589  | -    | 20            | -                   | 2.0  | 2.6  | 20            | Common anode   |
| VDMY10C0    | Yellow      | 1100                                  | 2750 | -    | 1             | -               | 589  | -    | 20            | -                   | 2.0  | 2.6  | 20            | Common cathode |
| VDMG10A0    | Green       | 110                                   | 400  | -    | 1             | -               | 572  | -    | 20            | -                   | 2.0  | 2.6  | 20            | Common anode   |
| VDMG10C0    | Green       | 110                                   | 400  | -    | 1             | -               | 572  | -    | 20            | -                   | 2.0  | 2.6  | 20            | Common cathode |

| ABSOLUTE MAXIMUM RATINGS ( $T_{\text{amb}} = 25^\circ\text{C}$ , unless otherwise specified) |                |                  |             |       |
|--|----------------|------------------|-------------|-------|
| VDMR10.0, VDMO10.0, VDMY10.0, VDMG10.0   |                |                  |             |       |
| PARAMETER  | TEST CONDITION | SYMBOL           | VALUE       | UNIT  |
| Power dissipation per segment  |                | $P_V$            | 70          | mW    |
| Peak forward current per segment (frequency 1 kHz, 10 % duty cycle)                          |                | $I_F$            | 60          | mA    |
| Continuous forward current per segment   |                | $I_F$            | 25          | mA    |
| Forward current derating from 25 °C  |                |                  | 0.28        | mA/°C |
| Operating temperature range  |                | $T_{\text{amb}}$ | -35 to +105 | °C    |
| Storage temperature range  |                | $T_{\text{stg}}$ | -35 to +105 | °C    |
| Iron soldering conditions: 1/16" below seating plane for 3 s at 260 °C                       |                |                  |             |       |



| <b>OPTICAL AND ELECTRICAL CHARACTERISTICS</b> ( $T_{amb} = 25\text{ }^{\circ}\text{C}$ , unless otherwise specified)<br><b>VDMR10A0, VDMR10C0, SUPER RED</b> |                      |                       |                 |      |      |      |                |
|--|----------------------|-----------------------|-----------------|------|------|------|----------------|
| PARAMETER  | TEST CONDITION       | PART                  | SYMBOL          | MIN. | TYP. | MAX. | UNIT           |
| Luminous intensity <sup>(1)</sup>  | $I_F = 1\text{ mA}$  | VDMR10A0              | $I_V$           | 180  | 650  | -    | $\mu\text{cd}$ |
|  |                      | VDMR10C0              |                 |      |      |      |                |
|  | $I_F = 10\text{ mA}$ | VDMR10A0              | $I_V$           | -    | 8250 | -    | $\mu\text{cd}$ |
|  |                      | VDMR10C0              |                 |      |      |      |                |
| Dominant wavelength  | $I_F = 20\text{ mA}$ | VDMR10A0,<br>VDMR10C0 | $\lambda_d$     | -    | 631  | -    | nm             |
| Peak emission wavelength   | $I_F = 20\text{ mA}$ |                       | $\lambda_p$     | -    | 639  | -    | nm             |
| Spectral line half-width   | $I_F = 10\text{ mA}$ |                       | $\Delta\lambda$ | -    | 20   | -    |                |
| Forward voltage per segment  | $I_F = 20\text{ mA}$ |                       | $V_F$           | -    | 2.0  | 2.6  | V              |
| Reverse current per segment <sup>(2)</sup>   | $V_R = 5\text{ V}$   |                       | $I_R$           | -    | -    | 100  | $\mu\text{A}$  |
| Luminous intensity matching ratio  | $I_F = 10\text{ mA}$ |                       | $I_{V-m}$       | -    | -    | 2:1  |                |

**Notes**

- (1) Luminous intensity is measured with a light sensor and filter combination that approximates the CIE eye-response curve.  
(2) Reverse voltage is only for IR test. It can not continue to operate at this situation.  
(3) Cross talk specification  $\leq 2.5\%$ .

| <b>OPTICAL AND ELECTRICAL CHARACTERISTICS</b> ( $T_{amb} = 25\text{ }^{\circ}\text{C}$ , unless otherwise specified)<br><b>VDMO10A0, VDMO10C0, SOFT ORANGE</b> |                      |                       |                 |      |      |      |                |
|--|----------------------|-----------------------|-----------------|------|------|------|----------------|
| PARAMETER  | TEST CONDITION       | PART                  | SYMBOL          | MIN. | TYP. | MAX. | UNIT           |
| Luminous intensity <sup>(1)</sup>  | $I_F = 1\text{ mA}$  | VDMO10A0              | $I_V$           | 180  | 650  | -    | $\mu\text{cd}$ |
|  |                      | VDMO10C0              |                 |      |      |      |                |
|  | $I_F = 10\text{ mA}$ | VDMO10A0              | $I_V$           | -    | 8250 | -    | $\mu\text{cd}$ |
|  |                      | VDMO10C0              |                 |      |      |      |                |
| Dominant wavelength  | $I_F = 20\text{ mA}$ | VDMO10A0,<br>VDMO10C0 | $\lambda_d$     | -    | 605  | -    | nm             |
| Peak emission wavelength   | $I_F = 20\text{ mA}$ |                       | $\lambda_p$     | -    | 611  | -    | nm             |
| Spectral line half-width   | $I_F = 10\text{ mA}$ |                       | $\Delta\lambda$ | -    | 17   | -    |                |
| Forward voltage per segment  | $I_F = 20\text{ mA}$ |                       | $V_F$           | -    | 2.0  | 2.6  | V              |
| Reverse current per segment <sup>(2)</sup>   | $V_R = 5\text{ V}$   |                       | $I_R$           | -    | -    | 100  | $\mu\text{A}$  |
| Luminous intensity matching ratio  | $I_F = 10\text{ mA}$ |                       | $I_{V-m}$       | -    | -    | 2:1  |                |

**Notes**

- (1) Luminous intensity is measured with a light sensor and filter combination that approximates the CIE eye-response curve.  
(2) Reverse voltage is only for IR test. It can not continue to operate at this situation.  
(3) Cross talk specification  $\leq 2.5\%$ .

| <b>OPTICAL AND ELECTRICAL CHARACTERISTICS</b> ( $T_{amb} = 25\text{ }^{\circ}\text{C}$ , unless otherwise specified)<br><b>VDMY10A0, VDMY10C0, YELLOW</b> |                      |                       |                 |      |        |      |                |
|---|----------------------|-----------------------|-----------------|------|--------|------|----------------|
| PARAMETER   | TEST CONDITION       | PART                  | SYMBOL          | MIN. | TYP.   | MAX. | UNIT           |
| Luminous intensity <sup>(1)</sup>   | $I_F = 1\text{ mA}$  | VDMY10A0              | $I_V$           | 1100 | 2750   | -    | $\mu\text{cd}$ |
|   |                      | VDMY10C0              |                 |      |        |      |                |
|   | $I_F = 10\text{ mA}$ | VDMY10A0              | $I_V$           | -    | 30 250 | -    | $\mu\text{cd}$ |
|   |                      | VDMY10C0              |                 |      |        |      |                |
| Dominant wavelength   | $I_F = 20\text{ mA}$ | VDMY10A0,<br>VDMY10C0 | $\lambda_d$     | -    | 589    | -    | nm             |
| Peak emission wavelength  | $I_F = 20\text{ mA}$ |                       | $\lambda_p$     | -    | 588    | -    | nm             |
| Spectral line half-width  | $I_F = 10\text{ mA}$ |                       | $\Delta\lambda$ | -    | 15     | -    |                |
| Forward voltage per segment   | $I_F = 20\text{ mA}$ |                       | $V_F$           | -    | 2.0    | 2.6  | V              |
| Reverse current per segment <sup>(2)</sup>  | $V_R = 5\text{ V}$   |                       | $I_R$           | -    | -      | 100  | $\mu\text{A}$  |
| Luminous intensity matching ratio   | $I_F = 10\text{ mA}$ |                       | $I_{V-m}$       | -    | -      | 2:1  |                |

**Notes**

- (1) Luminous intensity is measured with a light sensor and filter combination that approximates the CIE eye-response curve.  
(2) Reverse voltage is only for IR test. It can not continue to operate at this situation.  
(3) Cross talk specification  $\leq 2.5\%$ .



| OPTICAL AND ELECTRICAL CHARACTERISTICS (T <sub>amb</sub> = 25 °C, unless otherwise specified)<br>VDMG10A0, VDMG10C0, GREEN |                        |                       |                  |      |      |      |      |
|--|------------------------|-----------------------|------------------|------|------|------|------|
| PARAMETER  | TEST CONDITION         | PART                  | SYMBOL           | MIN. | TYP. | MAX. | UNIT |
| Luminous intensity <sup>(1)</sup>  | I <sub>F</sub> = 1 mA  | VDMG10A0              | I <sub>V</sub>   | 110  | 400  | -    | μcd  |
|  |                        | VDMG10C0              |                  |      |      |      |      |
|  | I <sub>F</sub> = 10 mA | VDMG10A0              | I <sub>V</sub>   | -    | 4400 | -    | μcd  |
|  |                        | VDMG10C0              |                  |      |      |      |      |
| Dominant wavelength  | I <sub>F</sub> = 20 mA | VDMG10A0,<br>VDMG10C0 | λ <sub>d</sub>   | -    | 572  | -    | nm   |
| Peak emission wavelength   | I <sub>F</sub> = 20 mA |                       | λ <sub>p</sub>   | -    | 571  | -    | nm   |
| Spectral line half-width   | I <sub>F</sub> = 10 mA |                       | Δλ               | -    | 15   | -    |      |
| Forward voltage per segment  | I <sub>F</sub> = 20 mA |                       | V <sub>F</sub>   | -    | 2.0  | 2.6  | V    |
| Reverse current per segment <sup>(2)</sup>   | V <sub>R</sub> = 5 V   |                       | I <sub>R</sub>   | -    | -    | 100  | μA   |
| Luminous intensity matching ratio  | I <sub>F</sub> = 10 mA |                       | I <sub>V-m</sub> | -    | -    | 2:1  |      |

Notes

- (1) Luminous intensity is measured with a light sensor and filter combination that approximates the CIE eye-response curve.
- (2) Reverse voltage is only for IR test. It can not continue to operate at this situation.
- (3) Cross talk specification ≤ 2.5 %.

| LUMINOUS INTENSITY CLASSIFICATION |                       |        |
|-----------------------------------|-----------------------|--------|
| GROUP                             | LIGHT INTENSITY (μcd) |        |
|                                   | MIN.                  | MAX.   |
| D                                 | 110                   | 220    |
| E                                 | 180                   | 360    |
| F                                 | 280                   | 560    |
| G                                 | 450                   | 900    |
| H                                 | 700                   | 1400   |
| I                                 | 1100                  | 2200   |
| K                                 | 1800                  | 3600   |
| L                                 | 2800                  | 5600   |
| M                                 | 4500                  | 9000   |
| N                                 | 7000                  | 14 000 |
| P                                 | 11 000                | 22 000 |
| Q                                 | 18 000                | 36 000 |
| R                                 | 28 000                | 56 000 |
| S                                 | 45 000                | 90 000 |

Note

- The above type numbers represent the order groups which include only a few brightness groups. Only one group will be shipped in one tube (there will be no mixing of two groups in one tube). In order to ensure availability, single brightness groups will not be orderable.

| COLOR CLASSIFICATION |             |      |        |      |       |      |
|----------------------|-------------|------|--------|------|-------|------|
| GROUP                | SOFT ORANGE |      | YELLOW |      | GREEN |      |
|                      | MIN.        | MAX. | MIN.   | MAX. | MIN.  | MAX. |
| 1                    | 598         | 601  | 581    | 584  | -     | -    |
| 2                    | 600         | 603  | 583    | 586  | -     | -    |
| 3                    | 602         | 605  | 585    | 588  | 562   | 565  |
| 4                    | 604         | 607  | 587    | 590  | 564   | 567  |
| 5                    | 606         | 609  | 589    | 592  | 566   | 569  |
| 6                    | 608         | 611  | 591    | 594  | 568   | 571  |
| 7                    | -           | -    | -      | -    | 570   | 573  |
| 8                    | -           | -    | -      | -    | 572   | 575  |

Note

- Wavelengths are tested at a current pulse duration of 25 ms.



## TYPICAL CHARACTERISTICS ( $T_{amb} = 25\text{ }^{\circ}\text{C}$ , unless otherwise specified)

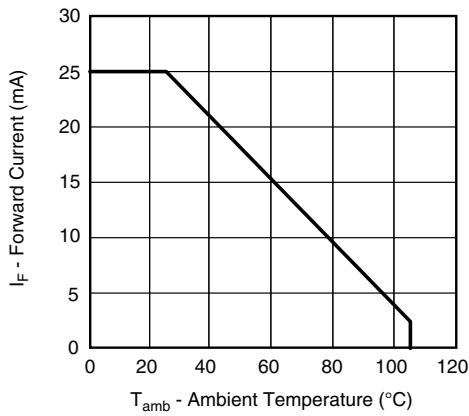

Fig. 1 - Forward Current vs. Ambient Temperature

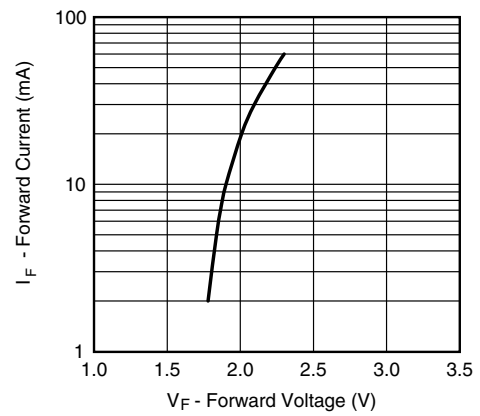

Fig. 4 - Forward Current vs. Forward Voltage

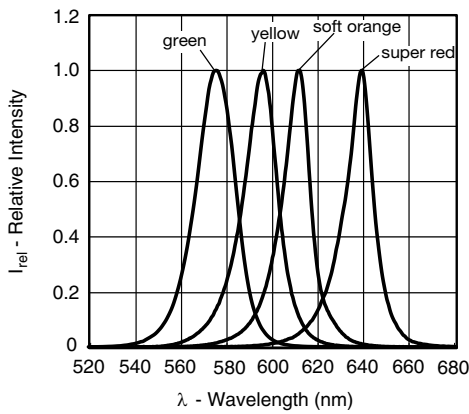

Fig. 2 - Relative Intensity vs. Wavelength

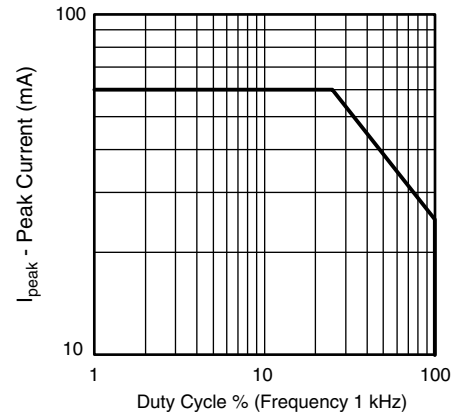

Fig. 5 - Peak Current vs. Duty Cycle

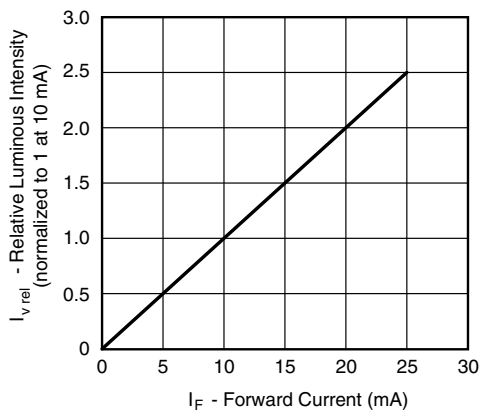
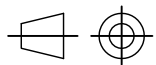
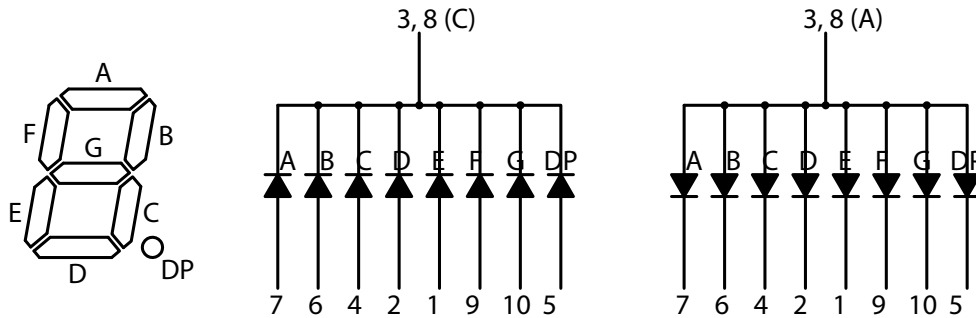
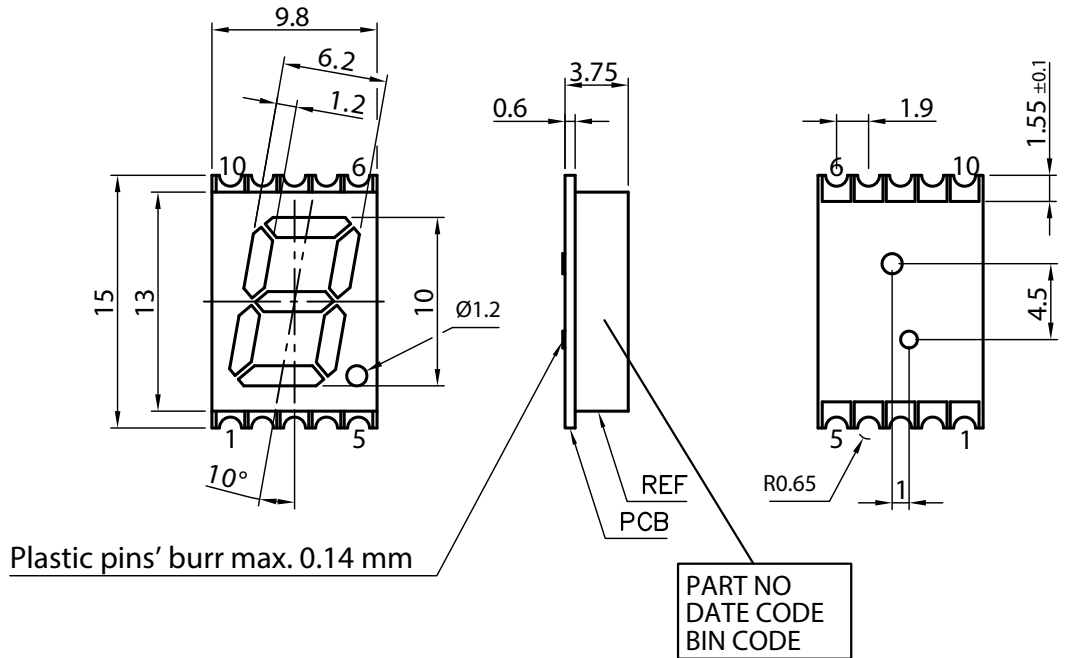

Fig. 3 - Relative Luminous Intensity vs. Forward Current



## PACKAGE DIMENSIONS in millimeters



technical drawings according to DIN specifications

Tolerances are  $\pm 0.25$  mm unless otherwise mentioned

Drawing-No.: 6.544-5425.01-4

Issue: 2; 02.10.13



## TAPE AND REEL DIMENSIONS in millimeters

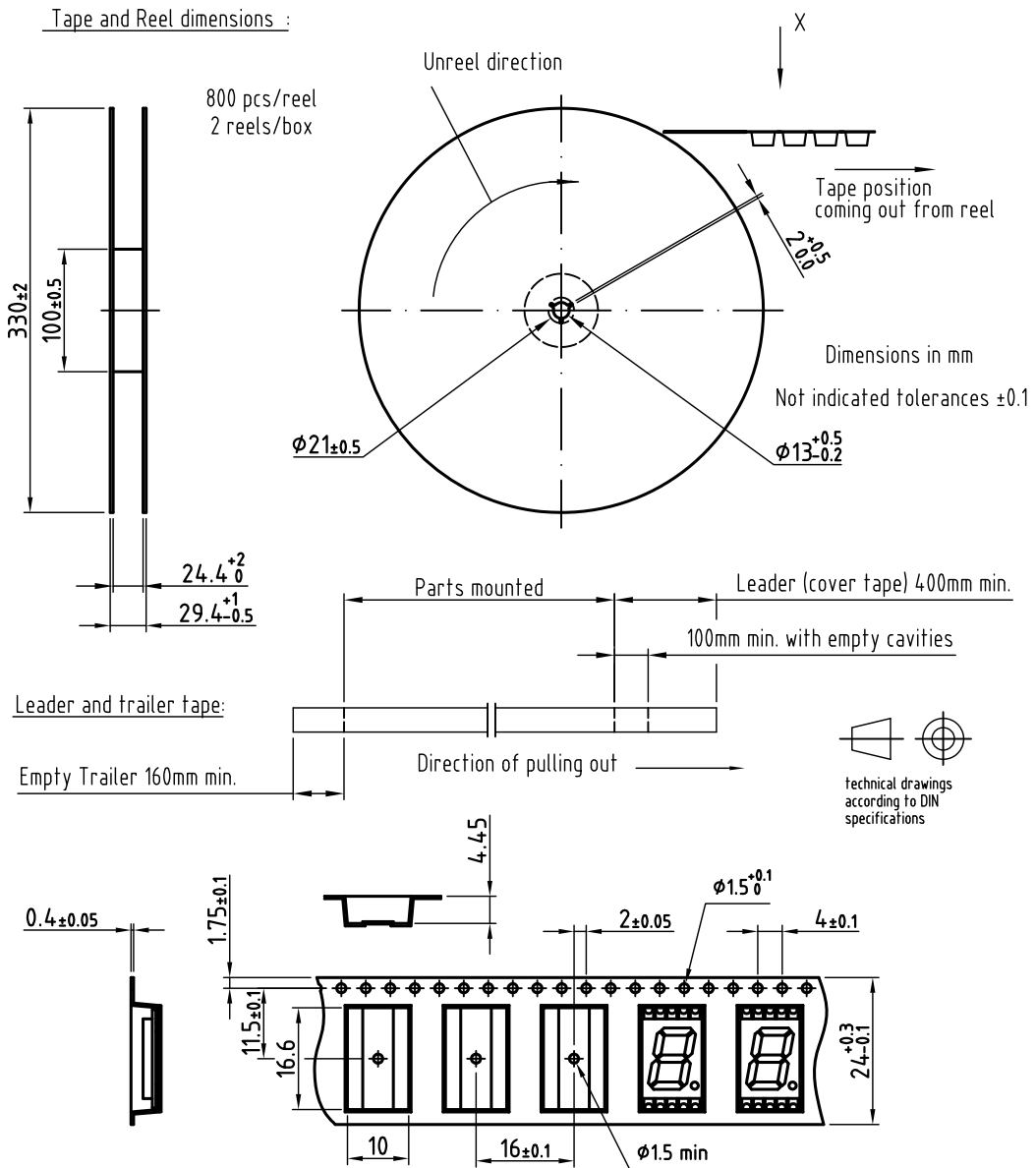

Drawing refers to following types: VDMx10x

Drawing-No.: 9.800-5125.01-4

Reel dimensions and tape

Issue: prel; 10.04.13

## TAPE IN BOX

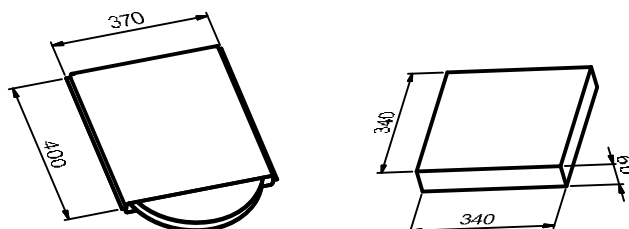



**BAR CODE PRODUCT LABEL** (example only)

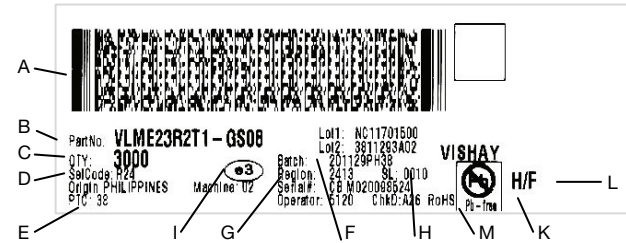

- A) 2D barcode
- B) Vishay part number
- C) Quantity
- D) PTC = selection code (binning)
- E) Code of manufacturing plant
- F) Batch = date code: year/week/plant code
- G) Region code
- H) SL = sales location
- I) Terminations finishing
- K) Lead (Pb)-free symbol
- L) Halogen-free symbol
- M) RoHS symbol

**SOLDERING PROFILE**

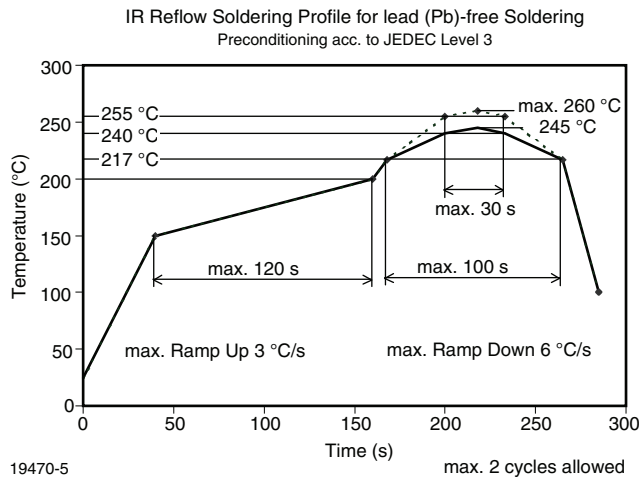
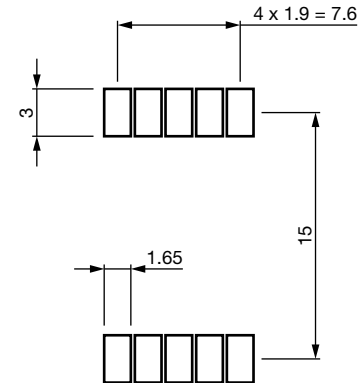

Fig. 6 - Vishay Lead (Pb)-free Reflow Soldering Profile (acc. to J-STD-020C)

| <b>SOLDERING IRON</b> (one time only) |             |
|---------------------------------------|-------------|
| Temperature                           | 300 °C max. |
| Soldering time                        | 3 s max.    |

**RECOMMENDED SOLDER PAD**



**MSL LABEL**

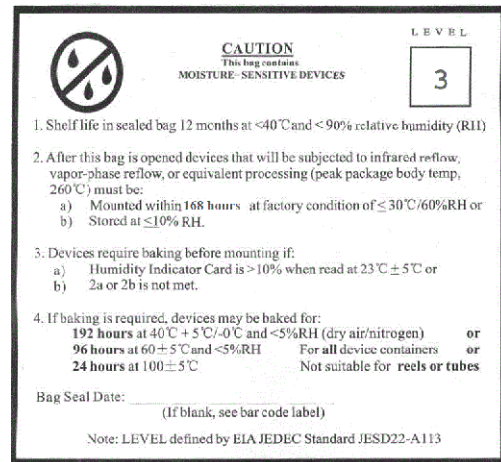



## **Disclaimer**

ALL PRODUCT, PRODUCT SPECIFICATIONS AND DATA ARE SUBJECT TO CHANGE WITHOUT NOTICE TO IMPROVE RELIABILITY, FUNCTION OR DESIGN OR OTHERWISE.

Vishay Intertechnology, Inc., its affiliates, agents, and employees, and all persons acting on its or their behalf (collectively, "Vishay"), disclaim any and all liability for any errors, inaccuracies or incompleteness contained in any datasheet or in any other disclosure relating to any product.

Vishay makes no warranty, representation or guarantee regarding the suitability of the products for any particular purpose or the continuing production of any product. To the maximum extent permitted by applicable law, Vishay disclaims (i) any and all liability arising out of the application or use of any product, (ii) any and all liability, including without limitation special, consequential or incidental damages, and (iii) any and all implied warranties, including warranties of fitness for particular purpose, non-infringement and merchantability.

Statements regarding the suitability of products for certain types of applications are based on Vishay's knowledge of typical requirements that are often placed on Vishay products in generic applications. Such statements are not binding statements about the suitability of products for a particular application. It is the customer's responsibility to validate that a particular product with the properties described in the product specification is suitable for use in a particular application. Parameters provided in datasheets and / or specifications may vary in different applications and performance may vary over time. All operating parameters, including typical parameters, must be validated for each customer application by the customer's technical experts. Product specifications do not expand or otherwise modify Vishay's terms and conditions of purchase, including but not limited to the warranty expressed therein.

Hyperlinks included in this datasheet may direct users to third-party websites. These links are provided as a convenience and for informational purposes only. Inclusion of these hyperlinks does not constitute an endorsement or an approval by Vishay of any of the products, services or opinions of the corporation, organization or individual associated with the third-party website. Vishay disclaims any and all liability and bears no responsibility for the accuracy, legality or content of the third-party website or for that of subsequent links.

Except as expressly indicated in writing, Vishay products are not designed for use in medical, life-saving, or life-sustaining applications or for any other application in which the failure of the Vishay product could result in personal injury or death. Customers using or selling Vishay products not expressly indicated for use in such applications do so at their own risk. Please contact authorized Vishay personnel to obtain written terms and conditions regarding products designed for such applications.

No license, express or implied, by estoppel or otherwise, to any intellectual property rights is granted by this document or by any conduct of Vishay. Product names and markings noted herein may be trademarks of their respective owners.