

4-Line BUS-Port ESD Protection

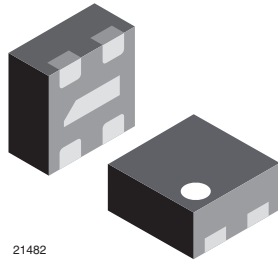

FEATURES

- Ultra compact LLP1010-5L package
- Low package profile < 0.4 mm
- 4-line ESD protection
- Low leakage current
- Low load capacitance $C_D = 0.8$ pF
- ESD immunity acc. IEC 61000-4-2
± 15 kV contact discharge
± 15 kV air discharge
- Pin plating NiPdAu (e4) no whisker growth
- Material categorization: for definitions of compliance please see www.vishay.com/doc?99912

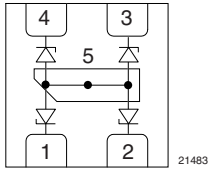

MARKING (example only)

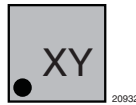

Dot = pin 1 marking
X = date code
Y = type code (see table below)

DESIGN SUPPORT TOOLS

[click logo to get started](#)



| ORDERING INFORMATION | | | |
|----------------------|--------------------|--|------------------------|
| DEVICE NAME | ORDERING CODE | TAPED UNITS PER REEL (8 mm TAPE ON 7" REEL) | MINIMUM ORDER QUANTITY |
| VBUS054DD-HF4 | VBUS054DD-HF4-GS08 | 5000 | 5000 |

| PACKAGE DATA | | | | | | |
|---------------|--------------|-----------|---------|---|--------------------------------------|------------------------------|
| DEVICE NAME | PACKAGE NAME | TYPE CODE | WEIGHT | MOLDING COMPOUND FLAMMABILITY RATING | MOISTURE SENSITIVITY LEVEL | SOLDERING CONDITIONS |
| VBUS054DD-HF4 | LLP1010-5L | C | 1.07 mg | UL 94 V-0 | MSL level 1 (according J-STD-020) | Peak temperature max. 260 °C |

| ABSOLUTE MAXIMUM RATINGS VBUS054DD-HF4 | | | | |
|--|--|-----------|-------------|------|
| PARAMETER | TEST CONDITIONS | SYMBOL | VALUE | UNIT |
| Peak pulse current | Pin 1, 2, 3 or 4 to pin 5 acc. IEC 61000-4-5; $t_p = 8/20$ μ s; single shot | I_{PPM} | 3 | A |
| Peak pulse power | Pin 1, 2, 3 or 4 to pin 5 acc. IEC 61000-4-5; $t_p = 8/20$ μ s; single shot | P_{PP} | 57 | W |
| ESD immunity | Contact discharge acc. IEC 61000-4-2; 10 pulses | V_{ESD} | ± 15 | kV |
| | Air discharge acc. IEC 61000-4-2; 10 pulses | | ± 15 | kV |
| Operating temperature | Junction temperature | T_J | -40 to +125 | °C |
| Storage temperature | | T_{STG} | -55 to +150 | °C |

| ELECTRICAL CHARACTERISTICS VBUS054DD-HF4 (Pin 1, 2, 3, or 4 to pin 5) | | | | | | |
|---|--|---------------|------|--------|------|---------|
| PARAMETER | TEST CONDITIONS/REMARKS | SYMBOL | MIN. | TYP. | MAX. | UNIT |
| Protection paths | Number of lines which can be protected | $N_{channel}$ | - | - | 4 | lines |
| Reverse stand-off voltage | Max. reverse working voltage | V_{RWM} | - | - | 5 | V |
| Reverse voltage | at $I_R = 0.1 \mu A$ | V_R | 5 | - | - | V |
| Reverse current | at $V_{IN} = V_{RWM} = 5 V$ | I_R | - | < 0.01 | 0.1 | μA |
| Reverse breakdown voltage | at $I_R = 1 mA$ | V_{BR} | 6.9 | 8 | 8.7 | V |
| Reverse clamping voltage | at $I_{PP} = 3 A$ acc. IEC 61000-4-5 | V_C | - | 16 | 19 | V |
| Forward clamping voltage | at $I_F = 12 A$ acc. IEC 61000-4-5 | V_F | - | 3.5 | 4.5 | V |
| Capacitance | $V_{IN} = 0 V$ | C_D | - | 0.8 | 1 | pF |
| | $V_{IN} = 2.5 V$ | C_D | - | 0.5 | 0.8 | pF |
| Line symmetry | Difference of the line capacitances | dC_D | - | - | 0.05 | pF |

Note

- $T_{amb} = 25 \text{ }^\circ C$, unless otherwise specified

TYPICAL CHARACTERISTICS ($T_{amb} = 25 \text{ }^\circ C$, unless otherwise specified)

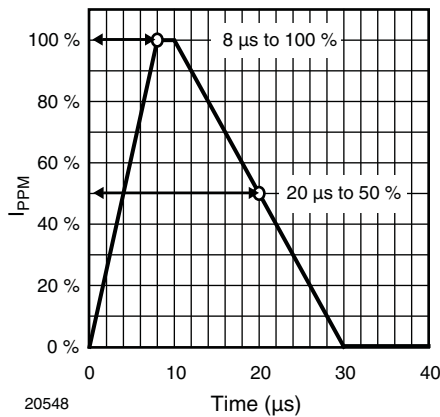

Fig. 1 - 8/20 μs Peak Pulse Current Wave Form acc. IEC 61000-4-5

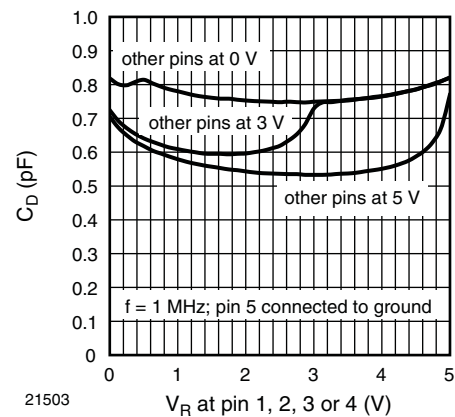

Fig. 3 - Typical Capacitance C_D vs. Reverse Voltage V_R

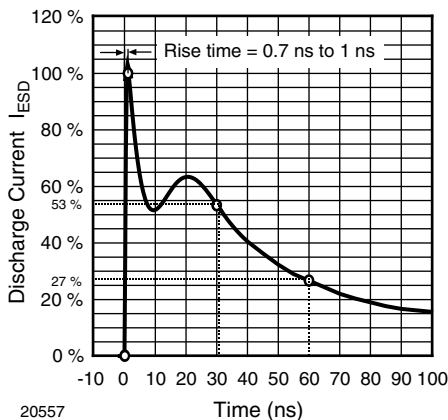

Fig. 2 - ESD Discharge Current Wave Form acc. IEC 61000-4-2 (330 Ω /150 pF)

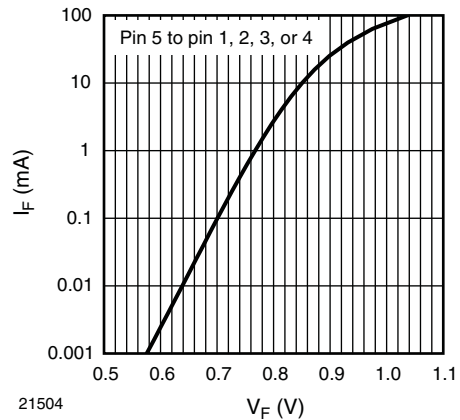

Fig. 4 - Typical Forward Current I_F vs. Forward Voltage V_F

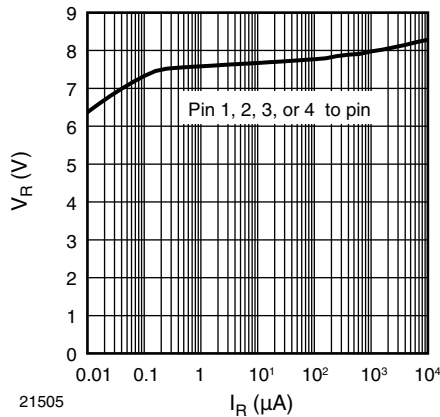

Fig. 5 - Typical Reverse Voltage V_R vs. Reverse Current I_R

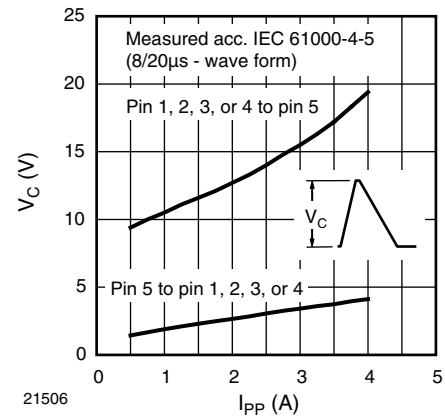
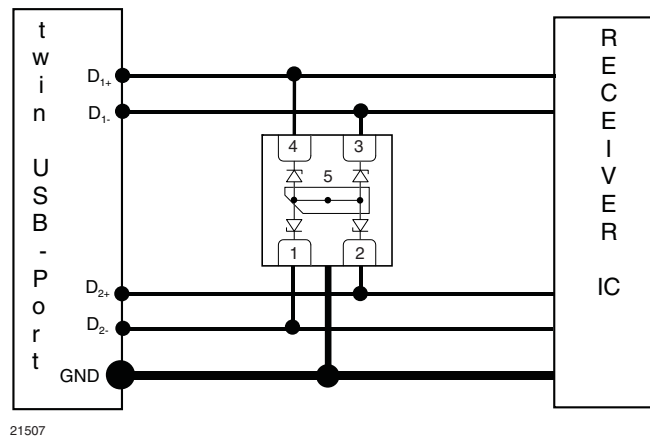

Fig. 6 - Typical Peak Clamping Voltage V_C vs. Peak Pulse Current I_{PP}

APPLICATION NOTE

With the VBUS054DD-HF4 a double, high speed USB-port or up to 4 other high speed signal or data lines can be protected against transient voltage signals. Negative transients will be clamped close below the ground level while positive transients will be clamped close above the 5 V working range. The high speed data lines, D_{1+} , D_{2+} , D_{1-} and D_{2-} , are connected to pin 1, 2, 3, and 4, pin 5 is connected to ground. As long as the signal voltage on the data lines is between the ground- and the breakthrough-level, the low input capacitance of each channel offer a very high isolation to ground and to the other data lines. But as soon as any transient signal exceeds this working range, the VBUS054DD-HF4 clamps the transient to ground or to the avalanche breakthrough voltage level.



BACKGROUND KNOWLEDGE

A zener- or avalanche diode is an ideal device for “cutting” or “clamping” voltage spikes or voltage transients down to low and uncritical voltage values. The breakthrough voltage can easily be adjusted by the chip-technology to any desired value within a wide range. Up to about 6 V the “zener-effect” (tunnel-effect) is responsible for the breakthrough characteristic. Above 6 V the so-called “avalanche-effect” is responsible. This is a more abrupt breakthrough phenomenon. Because of the typical “Z-shape” of the current-voltage-curve of such diodes, these diodes are generally called “Z-diode” (= zener or avalanche diodes). An equally important parameter for a protection diode is the ESD- and surge-power that allows the diode to short current in the pulse to ground without being destroyed.

This requirement can be adjusted by the size of the silicon chip (crystal). The bigger the active area the higher the current that the diode can short to ground.

But the active area is also responsible for the diode capacitance - the bigger the area the higher the capacitance.

The dilemma is that a lot of applications require an effective protection against more than 8 kV ESD while the capacitance must be lower than 5 pF! This is well out of the normal range of a Z-diode. However, a protection diode with a low capacitance PN-diode (switching diode or junction diode) in series with a Z-diode, can fulfil both requirements simultaneously: low capacitance AND high ESD- and/or surge immunity become possible!

A small signal ($V_{pp} < 100$ mV) just sees the low capacitance of the PN-diode, while the big capacitance of the Z-diode in series remains “invisible”.

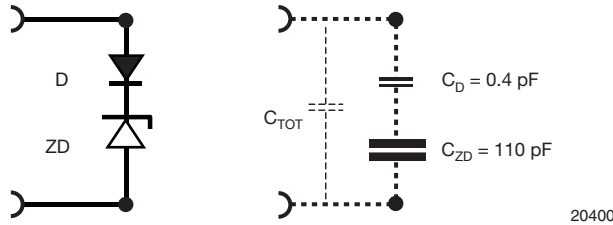

Such a constellation with a Z-diode and a small PN-diode (with low capacitance) in series (anti-serial) is a real unidirectional protection device. The clamping current can only flow in one direction (forward) in the PN-diode. The reverse path is blocked.

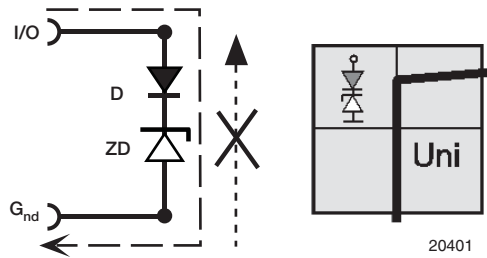

Another PN-diode “opens” the back path so that the protection device becomes bidirectional! Because the clamping voltage levels in forward and reverse directions are different, such a protection device has a **B**idirectional and **A**symmetrical clamping behaviour (**BiAs**) just like a single Z-diode.

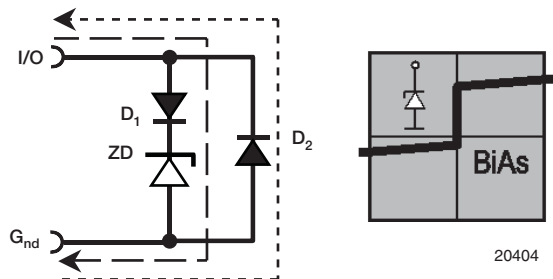

The VBUS054DD-HF4 offers four inputs with such protection circuit inside.

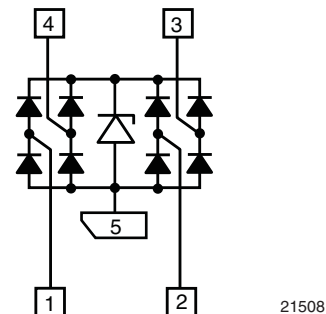



PACKAGE DIMENSIONS in millimeters (inches): **LLP1010-5L**

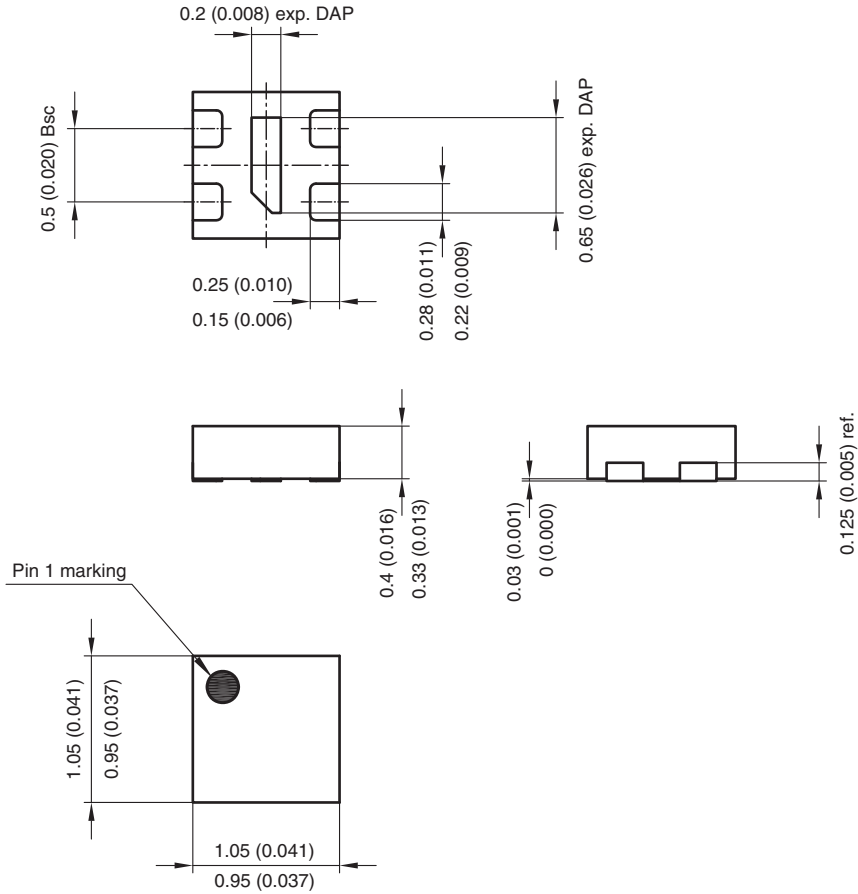

Foot print recommendation:

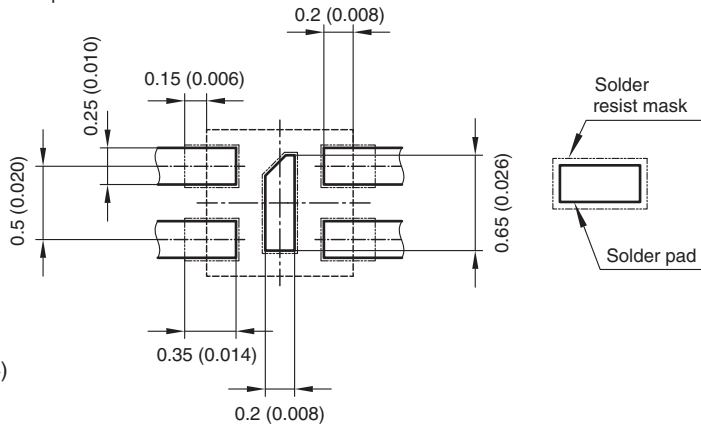

Document no.:S8-V-3906.04-007 (4)
Created - Date: 15. April. 2008
Rev. 3 - Date: 11. May. 2016
21380



Disclaimer

ALL PRODUCT, PRODUCT SPECIFICATIONS AND DATA ARE SUBJECT TO CHANGE WITHOUT NOTICE TO IMPROVE RELIABILITY, FUNCTION OR DESIGN OR OTHERWISE.

Vishay Intertechnology, Inc., its affiliates, agents, and employees, and all persons acting on its or their behalf (collectively, "Vishay"), disclaim any and all liability for any errors, inaccuracies or incompleteness contained in any datasheet or in any other disclosure relating to any product.

Vishay makes no warranty, representation or guarantee regarding the suitability of the products for any particular purpose or the continuing production of any product. To the maximum extent permitted by applicable law, Vishay disclaims (i) any and all liability arising out of the application or use of any product, (ii) any and all liability, including without limitation special, consequential or incidental damages, and (iii) any and all implied warranties, including warranties of fitness for particular purpose, non-infringement and merchantability.

Statements regarding the suitability of products for certain types of applications are based on Vishay's knowledge of typical requirements that are often placed on Vishay products in generic applications. Such statements are not binding statements about the suitability of products for a particular application. It is the customer's responsibility to validate that a particular product with the properties described in the product specification is suitable for use in a particular application. Parameters provided in datasheets and / or specifications may vary in different applications and performance may vary over time. All operating parameters, including typical parameters, must be validated for each customer application by the customer's technical experts. Product specifications do not expand or otherwise modify Vishay's terms and conditions of purchase, including but not limited to the warranty expressed therein.

Hyperlinks included in this datasheet may direct users to third-party websites. These links are provided as a convenience and for informational purposes only. Inclusion of these hyperlinks does not constitute an endorsement or an approval by Vishay of any of the products, services or opinions of the corporation, organization or individual associated with the third-party website. Vishay disclaims any and all liability and bears no responsibility for the accuracy, legality or content of the third-party website or for that of subsequent links.

Except as expressly indicated in writing, Vishay products are not designed for use in medical, life-saving, or life-sustaining applications or for any other application in which the failure of the Vishay product could result in personal injury or death. Customers using or selling Vishay products not expressly indicated for use in such applications do so at their own risk. Please contact authorized Vishay personnel to obtain written terms and conditions regarding products designed for such applications.

No license, express or implied, by estoppel or otherwise, to any intellectual property rights is granted by this document or by any conduct of Vishay. Product names and markings noted herein may be trademarks of their respective owners.