

Ultra compact and efficient 2-stage filter in ECO design for 3-phase systems



See below:

**Approvals and Compliances**

**Description**

- High attenuation value

**Applications**

- Voltage rating 480 VAC for world wide acceptance
- Especially designed for industrial applications such as: Frequency Converters, Stepper Motor Drives, UPS-Systems, Inverters
- Suitable for use in equipment according to IEC/UL 62368-1

**References**

We recommend for new applications the type [FMBC EP](#); [FMBC NEO](#)

**Weblinks**

[pdf data sheet](#), [html datasheet](#), [General Product Information](#), [Approvals](#), [Distributor-Stock-Check](#), [Detailed request for product](#), [Microsite](#)

**Technical Data**

Rated Current	10 - 115 A	Mounting	Screw-on mounting on chassis, upright / lengthwise
Rated voltage	480 VAC, 50/60 Hz	Terminal	Bolts and nuts
Approval for	10 - 115 A @ Ta 40 °C / 480 VAC; 50/60 Hz	Operating Temperature	-25 °C to 100 °C
Overload Current	1.5 x Ir for 1 minute, per hour	Climatic Category	25/100/21 acc. to IEC 60068-1
Leakage Current	standard < 0.5 mA (440 V / 50 Hz)	Degree of Protection	IP20 acc. to IEC 60529
Dielectric Strength	480 VAC: > 2.25 kVDC between L-L > 3 kVDC between L-PE between > 3 kVDC L-PE 50 Hz	Protection Class	Suitable for appliances with protection class I acc. to IEC 61140
Number of Filter Stages	2-stage	MTBF	> 200'000h acc. to MIL-HB-217 F
Weight	1.1 - 5 kg		
Material: Housing	Aluminum		
Sealing Compound	UL 94V-0		

**Approvals and Compliances**



Detailed information on product approvals, code requirements, usage instructions and detailed test conditions can be looked up in [Details about Approvals](#)

SCHURTER products are designed for use in industrial environments. They have approvals from independent testing bodies according to national and international standards. Products with specific characteristics and requirements such as required in the automotive sector according to IATF 16949, medical technology according to ISO 13485 or in the aerospace industry can be offered exclusively with customer-specific, individual agreements by SCHURTER.

**Approvals**

The approval mark is used by the testing authorities to certify compliance with the safety requirements placed on electronic products.

Approval Reference Type: FMBC ECO

Approval Logo	Certificates	Certification Body	Description
	<a href="#">VDE Approvals</a>	VDE	Certificate Number: 40023521
	<a href="#">UL Approvals</a>	UL	UR File Number: E72928

**Product standards**

Product standards that are referenced

Organization	Design	Standard	Description
	Designed according to	IEC 60939	Passive filters for suppressing electromagnetic interference
	Designed according to	UL 1283	Electromagnetic interference filters





**Application standards**

Application standards where the product can be used

Organization	Design	Standard	Description
	Suitable for applications acc.	IEC/UL 62368-1	Audio/video, information and communication technology equipment - Part 1: Safety requirements

**Compliances**

The product complies with following Guide Lines

Identification	Details	Initiator	Description
	<a href="#">CE declaration of conformity</a>	SCHURTER AG	The CE marking declares that the product complies with the applicable requirements laid down in the harmonisation of Community legislation on its affixing in accordance with EU Regulation 765/2008.
	<a href="#">UKCA declaration of conformity</a>	SCHURTER AG	The UKCA marking declares that the product complies with the applicable requirements laid down in the British Amendment of Regulation (EC) 765/2008.
	RoHS	SCHURTER AG	Directive RoHS 2011/65/EU, Amendment (EU) 2015/863
	China RoHS	SCHURTER AG	The law SJ / T 11363-2006 (China RoHS) has been in force since 1 March 2007. It is similar to the EU directive RoHS.
	REACH	SCHURTER AG	On 1 June 2007, Regulation (EC) No 1907/2006 on the Registration, Evaluation, Authorization and Restriction of Chemicals 1 (abbreviated as "REACH") entered into force.

**Dimension [mm]**

Case 94

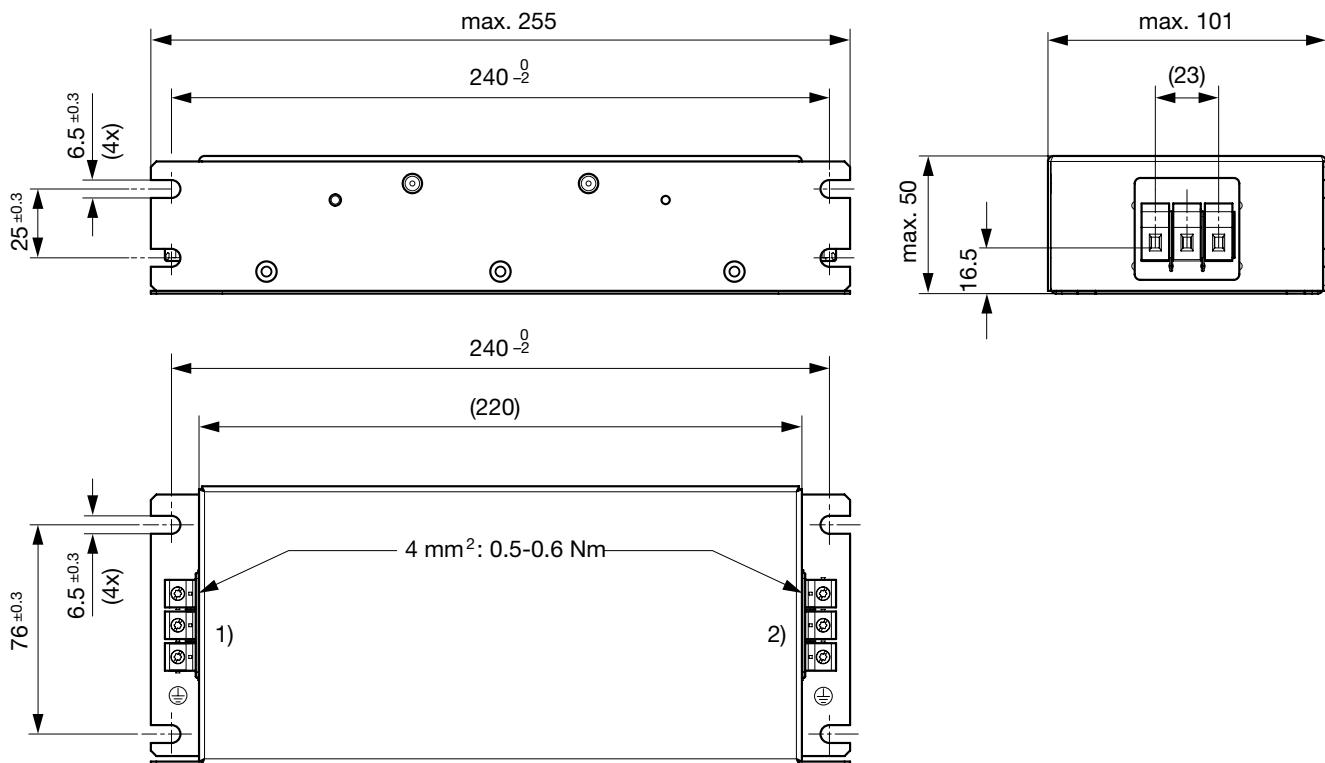

- 1) Line
- 2) Load

Case 95

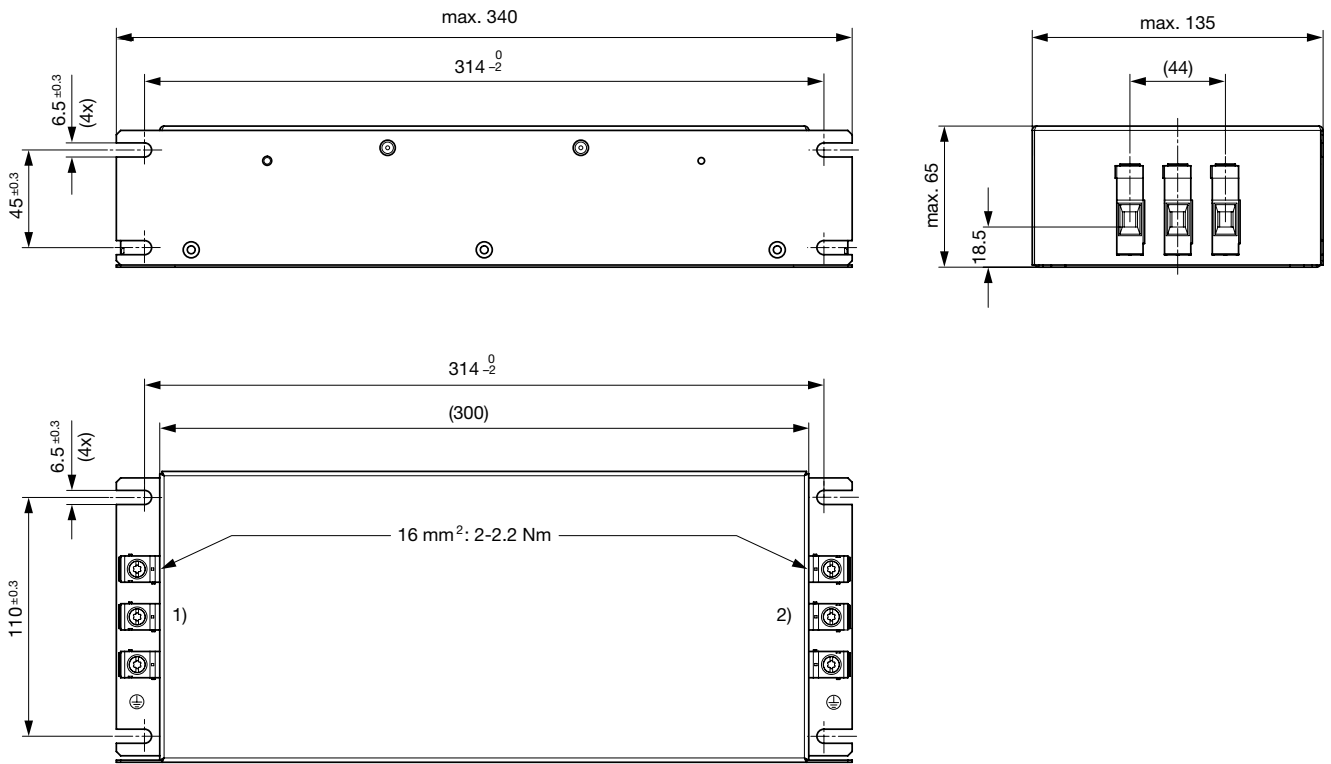

- 1) Line
- 2) Load

Case 96

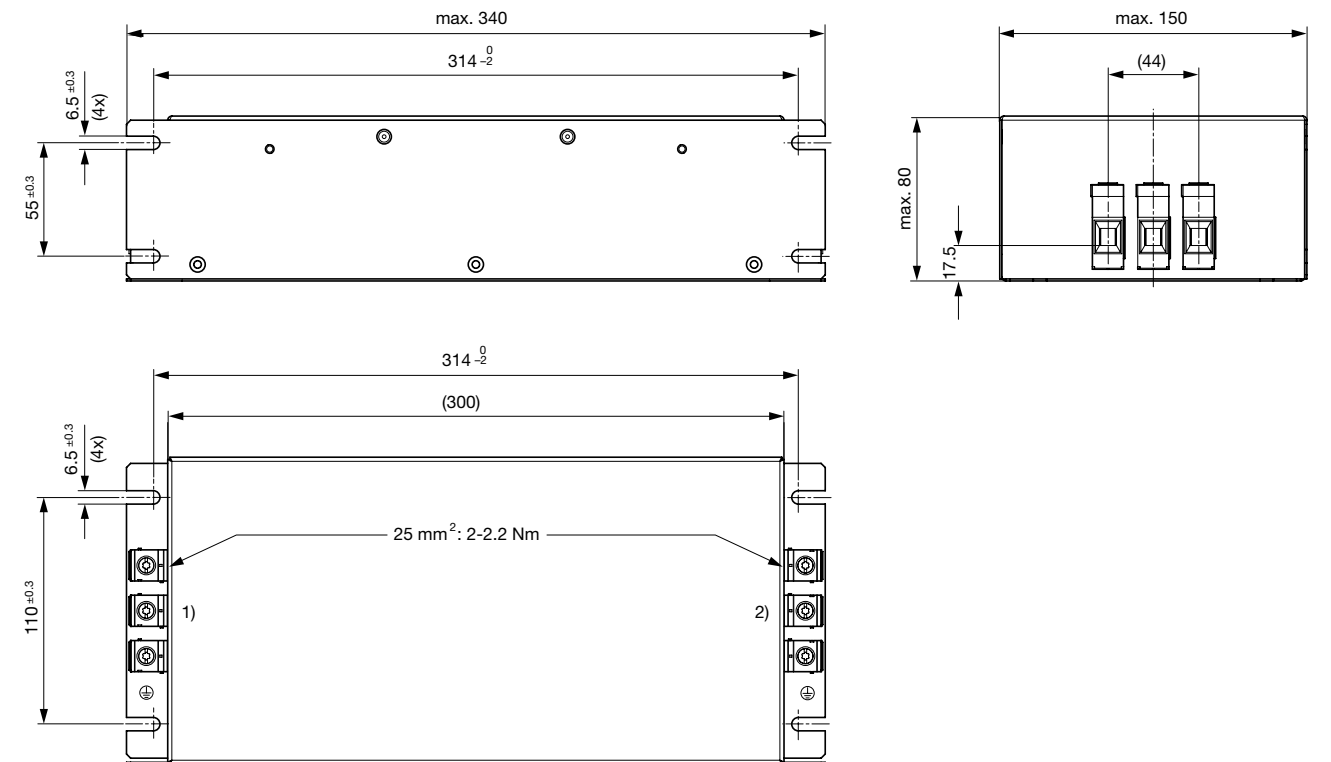

- 1) Line
- 2) Load

Case 97

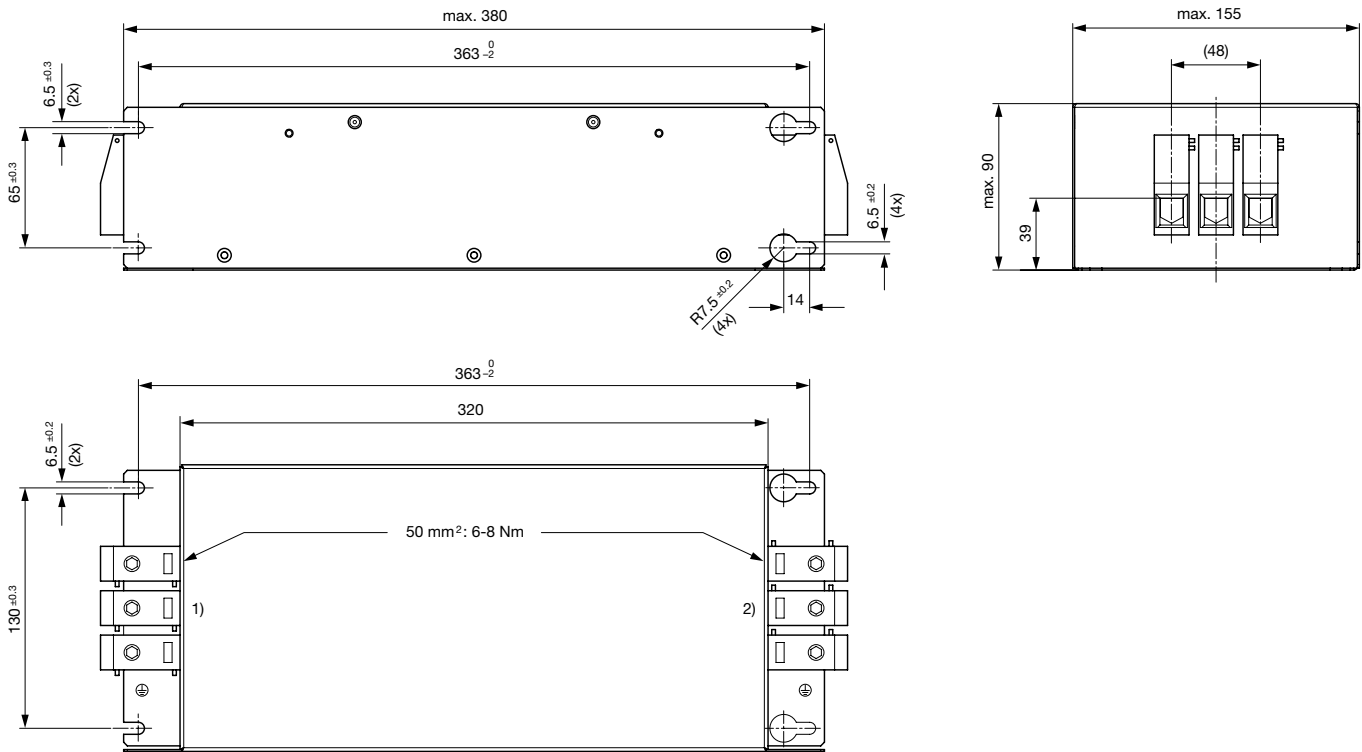

- 1) Line
- 2) Load

Technical data to the filter components

Rated Current [A]	L [mH]	C1 [µF]	C2 [µF]	C3 [µF]	C4 [nF]	R1 [MΩ]	R2 [MΩ]	Netzfilter Aus-
10	2.3	1	1	1	10	1	1	Indus-
20	1.5	1	1	1	10	1	1	Indus-
36	0.9	1	1	2.2	47	1	1	Indus-
50	0.45	1	1	2.2	47	1	1	Indus-
66	0.45	1	1	2.2	47	1	1	Indus-
80	0.32	1	1	2.2	47	1	1	Indus-
115	0.24	1	2.2	2.2	100	1	1	Indus-

Diagrams

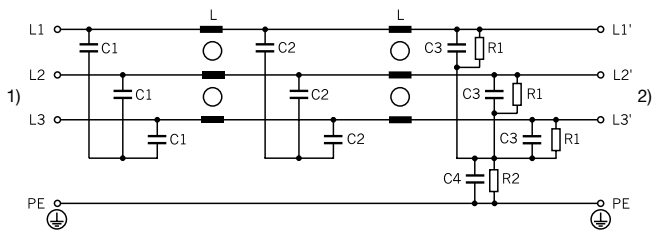

- 1) Line
- 2) Load

**Attenuation Loss**

--- 50Ω differential mode \_\_\_\_ 50Ω common mode

Industrial version

20A (FMBC-0994-2000)

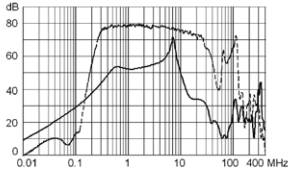

10A (FMBC-0994-1000)

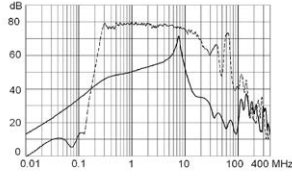

115A (FMBC-0997-H115)

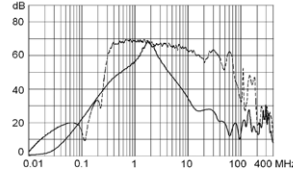

80A (FMBC-0996-8000)

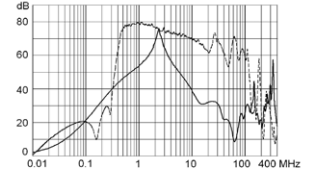

66A (FMBC-0996-6600)

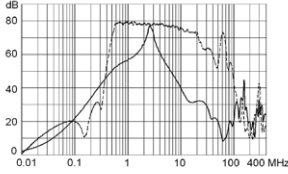

50A (FMBC-0996-5000)

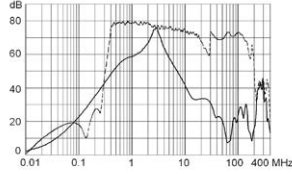

36A (FMBC-0995-3600)

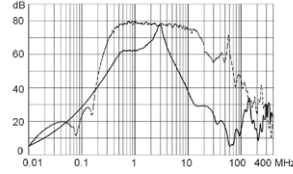

**All Variants**

Rated Current @ Ta 50°C (75°C) [A]	Tripped Power Dissipation [W]	Contact Resistance [mΩ]	Leakage Current [mA] @ 440V,	Weight [kg]	Screw clamps	Housing	Packaging unit [PCS]	Order Number
10	4	37	0.04	1.1 kg	4	94	1	FMBC-0994-1000
20	9	20	0.04	1.6 kg	4	94	1	FMBC-0994-2000
36	5	3.5	0.2	2.2 kg	16	95	1	FMBC-0995-3600
50	20	7.5	0.2	2.7 kg	16	95	1	FMBC-0995-5000
66	22	4.5	0.2	3.4 kg	25	96	1	FMBC-0996-6600
80	24	3.5	0.2	3.4 kg	25	96	1	FMBC-0996-8000
115	36	2.5	0.4	5 kg	50	97	1	FMBC-0997-H115

Most Popular.

Availability for all products can be searched real-time: <https://www.schurter.com/en/Stock-Check/Stock-Check-SCHURTER>

1) Leakage current according IEC 60939-1

2) Maximum conductor cross section (wire gauge) to be used; a comparative table for AWG and mm<sup>2</sup> values can be found in the general product information <https://www.schurter.com/en/FAQ#10>

**Packaging unit**

1 Pcs