



# High Precision TCXO / VCTCXO Oscillators

# CONNOR WINFIELD



2111 Comprehensive Drive

Aurora, Illinois 60505

Phone: 630-851-4722

Fax: 630-851-5040

www.conwin.com

## Description:

The Connor-Winfield's T100/T200 and the TV100/TV200 series have very high frequency stability with excellent phase noise performance. Available in a 5x7mm surface mount package. These TCXO's and VCTCXO's through the use of Analog Temperature Compensation are capable of holding sub 100-ppb or 200-ppb stabilities over the commercial or industrial temperature ranges. The surface mount package is designed for high-density mounting and is optimum for mass production.

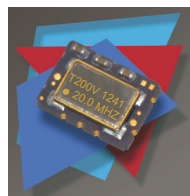

## Features:

### Models:

- T100 / T200-Series
- TV100 / TV200-Series
- Package
  - T100-T200 Series 5 x 7mm 10 Pad
  - TV100-TV200 Series 5 x 7mm 4 Pad
- Frequencies Available:
  - See frequency listing on page 2.
- 3.3 Vdc Operation
- Output Logic: LVCMOS
- Frequency Stability:
  - T100 / TV100: +/-100 ppb, 0 to 70°C
  - T200 / TV200: +/-200 ppb, -40 to 85°C
- Fixed Frequency - TCXO
- Optional Control Voltage - VCTCXO
- Low Jitter <0.50 ps RMS
- Low Phase Noise
- Tri-State Enable/Disable:
  - Available on T100 / T200 Models.
- Tape and Reel Packaging
- RoHS Compliant / Lead Free ✓RoHS

## Applications:

Basestation, Communications, DSL / ADSL, Femtocell, IP Timing, LTE, Precision GPS, SONET / SDH, WiMAX / WiBro, WLAN.

## Absolute Maximum Ratings

Parameter	Minimum	Nominal	Maximum	Units	Notes
Storage Temperature	-40	-	85	°C	
Supply Voltage (Vcc)	-0.5	-	4.6	Vdc	
Input Voltage (Vc)	-0.5	-	Vcc + 0.5	Vdc	

## Ordering Information

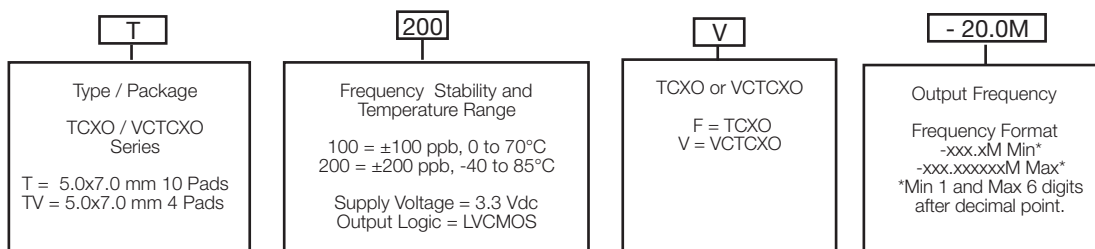

Example: Part Number

T100F-019.2M = 5x7mm 10 pad package, ±100 ppb, 0 to 70°C, 3.3 Vdc, LVCMOS Output, TCXO, 19.2 MHz  
 T200V-020.0M = 5x7mm 10 pad package, ±200 ppb, -40 to 85°C, 3.3 Vdc, LVCMOS Output, VCTCXO, 20.0 MHz  
 TV100F-010.0M = 5x7mm 4 pad package, ±100 ppb, 0 to 70°C, 3.3 Vdc, LVCMOS Output, TCXO, 10.0 MHz  
 TV200V-012.8M = 5x7mm 4 pad package, ±200 ppb, -40 to 85°C, 3.3 Vdc, LVCMOS Output, VCTCXO, 12.8 MHz





## Operating Specifications

Parameter	Minimum	Nominal	Maximum	Units	Notes
Available Output Frequencies (Fo)		10.0 12.8 14.7456 19.2 20.0 24.576 25.0 40.0 50.0		MHz MHz MHz MHz MHz MHz MHz MHz MHz	
Frequency Calibration @ 25 °C	-1.0	-	1.0	ppm	1
Frequency Stability	(See Ordering Information for full part number)				
Model T100x, TV100x	-100	-	100	ppb	2
Model T200x, TV200x	-200	-	200	ppb	2
Frequency vs. Load Stability	-0.05	-	0.05	ppm	±5%
Frequency vs. Voltage Stability	-0.05	-	0.05	ppm	±5%
Static Temperature Hysteresis	-	-	0.40	ppm	3
Freq. shift after reflow soldering	-1.0	-	1.0	ppm	4
Long Term Stability	-1.0	-	1.0	ppm	5
Aging					
per Life (20 Years)	-3.0	-	3.0	ppm	
per Day	-40	-	40	ppb	
per Second	-	4.63E-13	-		
Operating Temperature Range	(See Ordering Information for full part number)				
Model T100x, TV100x	0	-	70	°C	
Model T200x, TV200x	-40	-	85	°C	
Supply Voltage (Vcc)	3.135	3.30	3.465	Vdc	
Supply Current (Icc)	-	-	6.5	mA	
Jitter:					
Period Jitter	-	3.0	5.0	ps RMS	
Integrated Phase Jitter (12K to 20M)	-	0.3	1.0	ps RMS	6
SSB Phase Noise for Fo=10.0 MHz					
@ 1 Hz offset	-	-60	-	dBc/Hz	
@ 10 Hz offset	-	-98	-	dBc/Hz	
@ 100 Hz offset	-	-126	-	dBc/Hz	
@ 1 KHz offset	-	-143	-	dBc/Hz	
@ 10 KHz offset	-	-151	-	dBc/Hz	
@ 100 KHz offset	-	-152	-	dBc/Hz	
@ 1 MHz offset	-	-155	-	dBc/Hz	
Start-Up Time	-	-	10	ms	

## Control Voltage Input Characteristics

Parameter	Minimum	Nominal	Maximum	Units	Notes
Control Voltage	0.3	1.65	3.0	V	
Frequency Pullability	±10	-	-	ppm	
Control Voltage Slope	Positive Slope				
Monotonic Linearity	-	-	10	%	
Input Impedance	100K	-	-	Ohm	
Modulation Bandwidth (3dB)	10	-	-	KHz	

**Enable /Disable Input Characteristics (Pad 8)  
(Models T100F, T200F, T100V and T200V Only)**

Parameter	Minimum	Nominal	Maximum	Units	Notes
Enable Input Voltage -(Vih)	70%Vcc	-	-	Vdc	7
Disable Input Voltage - (Vil)	-	-	30%Vcc	Vdc	7

Function	Output
Low:	Disabled (High Impedance)
High or Open:	Enabled

**LVC MOS Output Characteristics**

Parameter	Minimum	Nominal	Maximum	Units	Notes
Load (CL)	-	15	-	pF	8
Voltage (High) (Voh)	90%Vcc	-	-	Vdc	
(Low) (Vol)	-	-	10%Vcc	Vdc	
Duty Cycle at 50% of Vcc	45	50	55	%	
Rise / Fall Time 10% to 90%	-	4	8	ns	

**Package Characteristics**

Package	Hermetically sealed ceramic package with grounded metal cover
---------	---

**Environmental Characteristics**

Vibration:	Vibration per Mil Std 883E Method 2007.3 Test Condition A.
Shock:	Mechanical Shock per Mil Std 883E Method 2002.4 Test Condition B.
Soldering Process:	RoHS compliant lead free. See soldering profile on page 6.

**Notes:**

1. Initial calibration @ 25°C. ±2°C, for VCTCXO's Vc = 1.65V. Specifications at time of shipment after 48 hours of operation.
2. Frequency stability vs. change in temperature.  $[\pm(F_{max}-F_{min})/2.F_0]$ . For VCTCXO's - Vc = 1.65V
3. Frequency change after reciprocal temperature ramped over the operating range. Frequency measured before and after at 25°C
4. Two consecutive reflows after 1 hour recovery @ 25°C.
5. Frequency drift over 1 year @ 25°C.
6. BW = 12 KHz to Fo/2 MHz
7. Leave Pad 8 on models, T100F, T200F, T100V, T200V unconnected if enable / disable function is not required. When tri-stated, the output stage is disabled but the oscillator and compensation circuit are still active (current consumption < 1 mA).
8. Attention: To achieve optimal frequency stability, and in some cases to meet the specification stated on this data sheet, it is required that the circuit connected to this TCXO output must have the equivalent input capacitance that is specified by the nominal load capacitance. Deviations from the nominal load capacitance will have a graduated effect on the stability of approximately 20 ppb per pF load difference.

Bulletin	<b>Tx350</b>
Page	<b>3 of 6</b>
Revision	<b>09</b>
Date	<b>20 March 2018</b>

## T100/T200 Package Outline

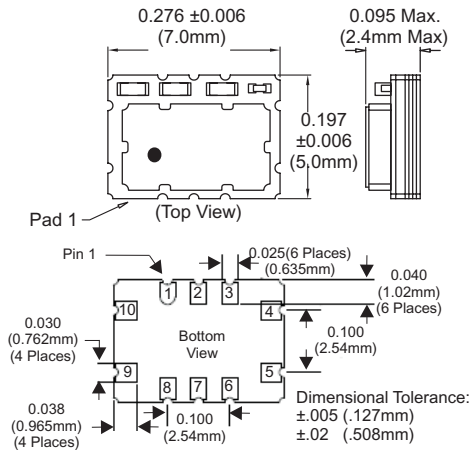

## T100/T200 Suggested Pad Layout

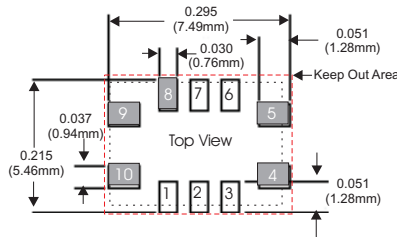

\* Do not route any traces in the keep out area. It is recommended the next layer under the keep out area is to be ground plane.

## T100/T200 Pad Connections

1:	Do Not Connect
2:	Do Not Connect
3:	Do Not Connect
4:	Ground
5:	Output
6:	Do Not Connect
7:	Do Not Connect
8:	Enable / Disable
9:	Supply Voltage (Vcc)
10:	VCTCXO: Control Voltage (Vc) TCXO: N/C

## TV100/TV200 Package Outline

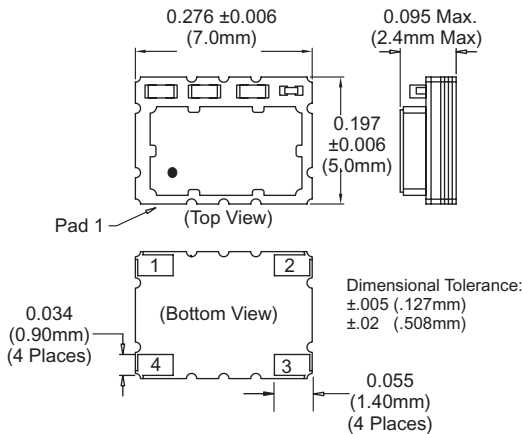

## TV100/TV200 Suggested Pad Layout

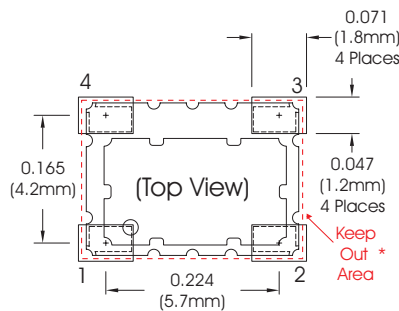

\* Do not route any traces in the keep out area. It is recommended the next layer under the keep out area is to be ground plane.

## TV100/TV200 Pad Connections

1:	VCTCXO: Voltage Control (Vc) TCXO: N/C
2:	Ground
3:	Output
4:	Supply (Vcc)

## Marking Information

The marking varies with design configuration. All marking configurations below are valid.

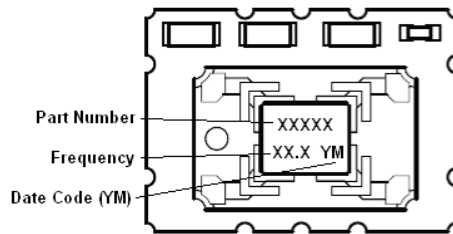
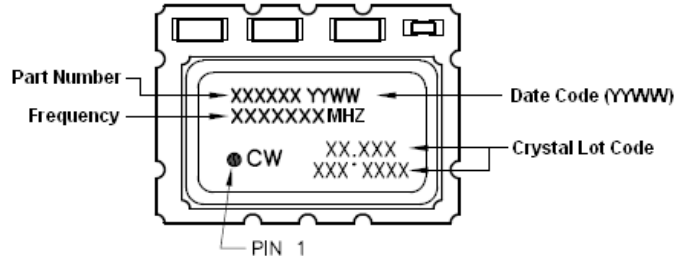
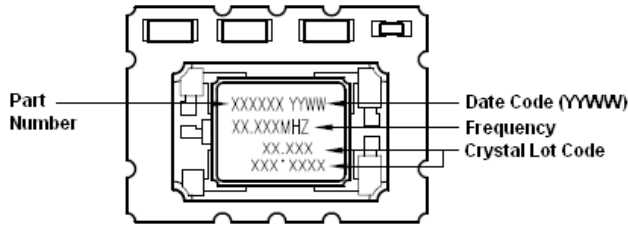

### 2 CHARACTER DATE CODE

Y = Year	M = MONTH
8 = 2018	A = JAN
9 = 2019	B = FEB
0 = 2020	C = MAR
1 = 2021	D = APR
	E = MAY
	F = JUN
	G = JUL
	H = AUG
	J = SEP
	K = OCT
	M = NOV
	N = DEC

## T100 / T200 Design Recommendations

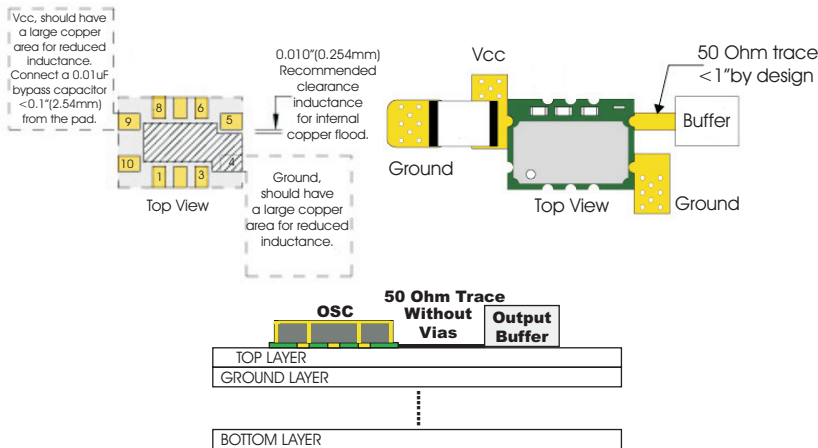

## T100 / T200 Test Circuit

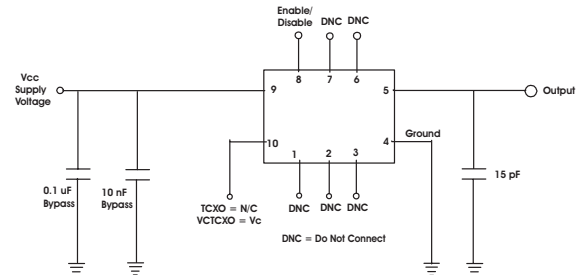

## TV100 / TV200 Design Recommendations

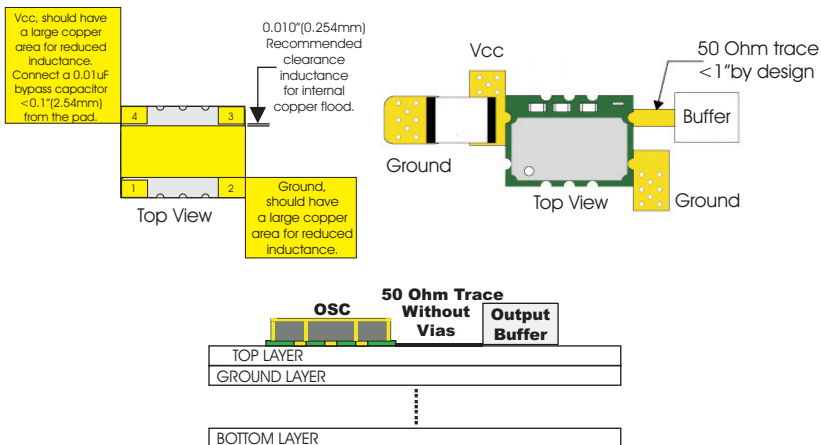

## TV100 / TV200 Test Circuit

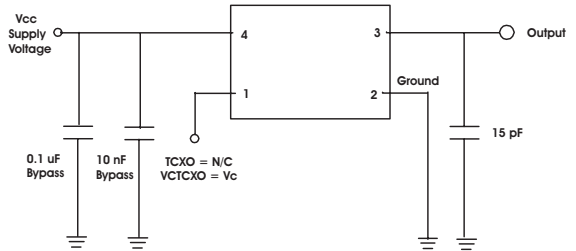



## LVMOS Output Waveform

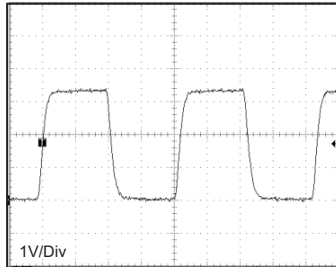

## Typical Phase Noise for TV100F-010.0M

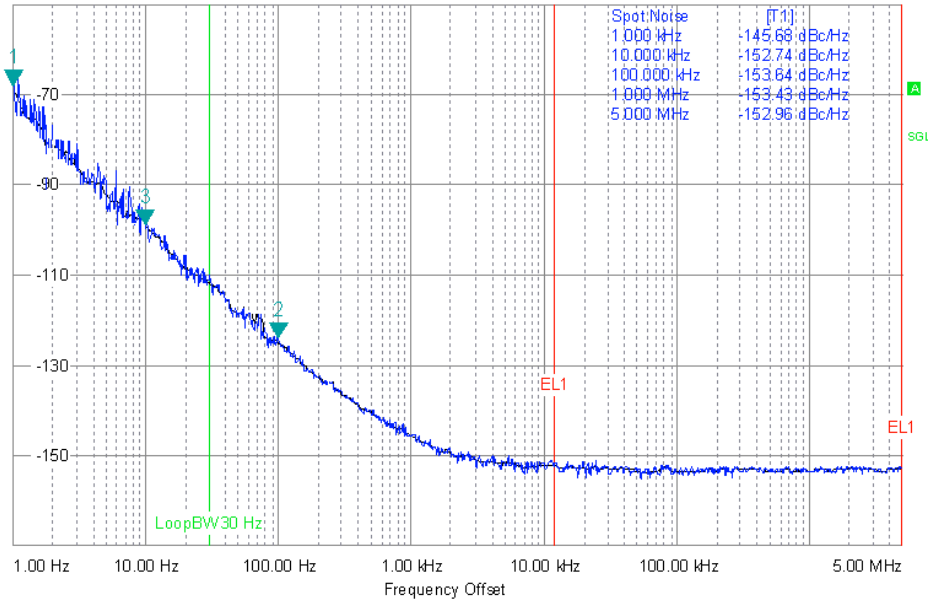

## Solder Profile

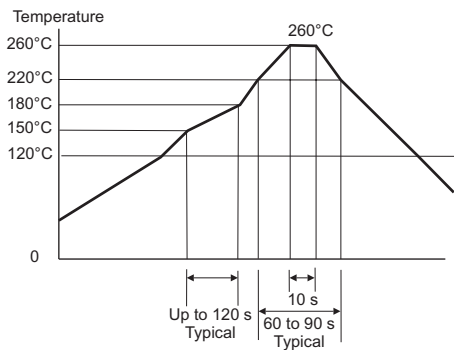

Meets IPC/JEDEC J-STD-020C

## 5x7 mm Tape and Reel Information

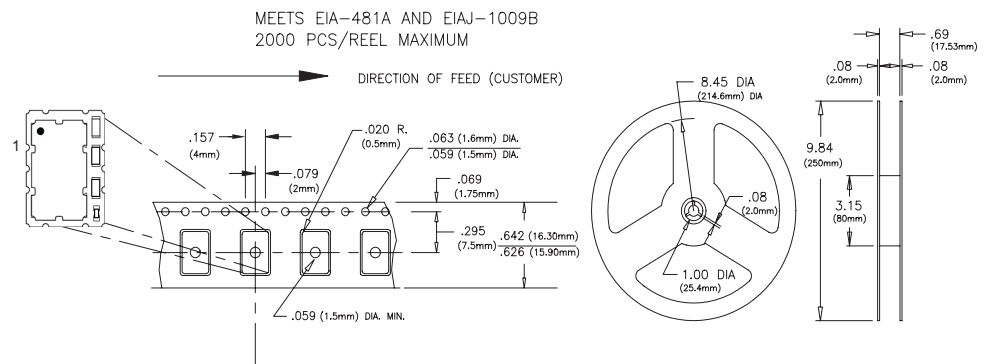

## Revision History

Revision	Date	Changes
A00	12/05/11	Advanced information data sheet released
A01	04/24/12	Added 12.8 MHz and +/-50ppb 0 to 70°C Models
02	04/26/12	Updated integrated phase jitter to 0.3 ps RMS nominal.
03	10/12/12	Removed M series
04	01/09/13	Updated phase noise information
05	02/04/15	Updated to 24.576 MHz and 40.0 MHz Frequencies
06	06/15/16	Input Voltage, Frequency vs Load and Voltage Stability edits
07	09/28/16	Update Marking Information
08	04/25/17	Corrected T100/T200 package drawing bottom view
09	03/20/18	Removed Alternate Package information, changed product height to 2.4mm Max and updated max supply current.

Bulletin	Tx350
Page	6 of 6
Revision	09
Date	20 March 2018