

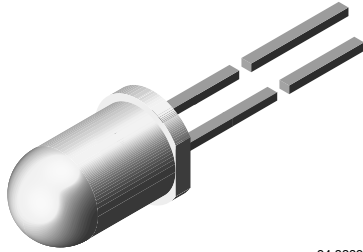

## Infrared Emitting Diode, 875 nm, GaAlAs



94 8389

### FEATURES

- Package type: leaded
- Package form: T-1 $\frac{3}{4}$
- Dimensions (in mm):  $\varnothing$  5
- Peak wavelength:  $\lambda_p = 875$  nm
- High reliability
- Angle of half intensity:  $\varphi = \pm 12^\circ$
- Low forward voltage
- Suitable for high pulse current operation
- Good spectral matching with Si photodetectors
- Compliant to RoHS Directive 2002/95/EC and in accordance to WEEE 2002/96/EC



**RoHS**  
COMPLIANT  
**GREEN**  
(5-2008)\*\*

### DESCRIPTION

The TSHA620. series are infrared, 875 nm emitting diodes in GaAlAs technology, molded in a clear, untinted plastic package.

### Note

\*\* Please see document "Vishay Material Category Policy": [www.vishay.com/doc?99902](http://www.vishay.com/doc?99902)

### APPLICATIONS

- Infrared remote control and free air data transmission systems
- This emitter series is dedicated to systems with panes in transmission space between emitter and detector, because of the low absorption of 875 nm radiation in glass

PRODUCT SUMMARY				
COMPONENT	$I_e$ (mW/sr)	$\varphi$ (deg)	$\lambda_p$ (nm)	$t_r$ (ns)
TSHA6200	40	$\pm 12$	875	600
TSHA6201	50	$\pm 12$	875	600
TSHA6202	60	$\pm 12$	875	600
TSHA6203	65	$\pm 12$	875	600

### Note

- Test conditions see table "Basic Characteristics"

ORDERING INFORMATION			
ORDERING CODE	PACKAGING	REMARKS	PACKAGE FORM
TSHA6200	Bulk	MOQ: 4000 pcs, 4000 pcs/bulk	T-1 $\frac{3}{4}$
TSHA6201	Bulk	MOQ: 4000 pcs, 4000 pcs/bulk	T-1 $\frac{3}{4}$
TSHA6202	Bulk	MOQ: 4000 pcs, 4000 pcs/bulk	T-1 $\frac{3}{4}$
TSHA6203	Bulk	MOQ: 4000 pcs, 4000 pcs/bulk	T-1 $\frac{3}{4}$

### Note

- MOQ: minimum order quantity



ABSOLUTE MAXIMUM RATINGS ( $T_{amb} = 25\text{ }^{\circ}\text{C}$ , unless otherwise specified)				
PARAMETER	TEST CONDITION	SYMBOL	VALUE	UNIT
Reverse voltage		$V_R$	5	V
Forward current		$I_F$	100	mA
Peak forward current	$t_p/T = 0.5$ , $t_p = 100\text{ }\mu\text{s}$	$I_{FM}$	200	mA
Surge forward current	$t_p = 100\text{ }\mu\text{s}$	$I_{FSM}$	2.5	A
Power dissipation		$P_V$	180	mW
Junction temperature		$T_j$	100	$^{\circ}\text{C}$
Operating temperature range		$T_{amb}$	- 40 to + 85	$^{\circ}\text{C}$
Storage temperature range		$T_{stg}$	- 40 to + 100	$^{\circ}\text{C}$
Soldering temperature	$t \leq 5\text{ s}$ , 2 mm from case	$T_{sd}$	260	$^{\circ}\text{C}$
Thermal resistance junction/ambient	J-STD-051, leads 7 mm, soldered on PCB	$R_{thJA}$	230	K/W

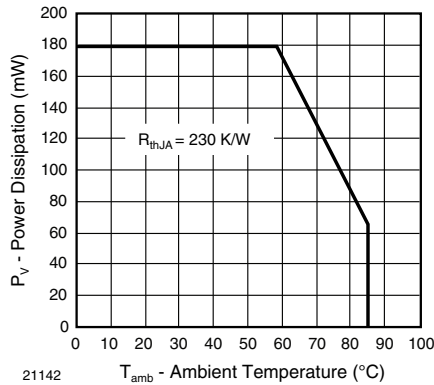

Fig. 1 - Power Dissipation Limit vs. Ambient Temperature

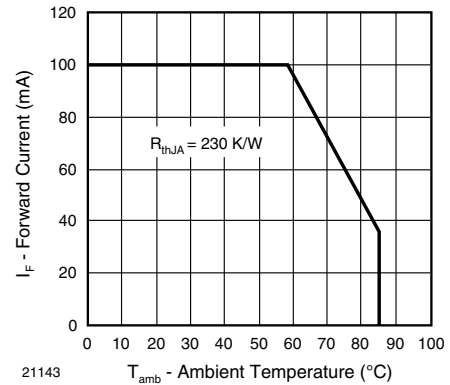

Fig. 2 - Forward Current Limit vs. Ambient Temperature

BASIC CHARACTERISTICS ( $T_{amb} = 25\text{ }^{\circ}\text{C}$ , unless otherwise specified)						
PARAMETER	TEST CONDITION	SYMBOL	MIN.	TYP.	MAX.	UNIT
Forward voltage	$I_F = 100\text{ mA}$ , $t_p = 20\text{ ms}$	$V_F$		1.5	1.8	V
Temperature coefficient of $V_F$	$I_F = 100\text{ mA}$	$TK_{V_F}$		- 1.6		mV/K
Reverse current	$V_R = 5\text{ V}$	$I_R$			100	$\mu\text{A}$
Junction capacitance	$V_R = 0\text{ V}$ , $f = 1\text{ MHz}$ , $E = 0$	$C_j$		20		pF
Temperature coefficient of $\phi_e$	$I_F = 20\text{ mA}$	$TK_{\phi_e}$		- 0.7		%/K
Angle of half intensity		$\phi$		$\pm 12$		deg
Peak wavelength	$I_F = 100\text{ mA}$	$\lambda_p$		875		nm
Spectral bandwidth	$I_F = 100\text{ mA}$	$\Delta\lambda$		80		nm
Temperature coefficient of $\lambda_p$	$I_F = 100\text{ mA}$	$TK_{\lambda_p}$		0.2		nm/K
Rise time	$I_F = 100\text{ mA}$	$t_r$		600		ns
	$I_F = 1\text{ A}$	$t_r$		300		ns
Fall time	$I_F = 100\text{ mA}$	$t_f$		600		ns
	$I_F = 1\text{ A}$	$t_f$		300		ns
Virtual source diameter		$d$		3.7		mm



TYPE DEDICATED CHARACTERISTICS ( $T_{amb} = 25\text{ }^{\circ}\text{C}$ , unless otherwise specified)							
PARAMETER	TEST CONDITION	PART	SYMBOL	MIN.	TYP.	MAX.	UNIT
Forward voltage	$I_F = 1\text{ A}$ , $t_p = 100\text{ }\mu\text{s}$	TSHA6200	$V_F$		2.8	3.5	V
		TSHA6201	$V_F$		2.8	3.5	V
		TSHA6202	$V_F$		2.8	3.5	V
		TSHA6203	$V_F$		2.8	3.5	V
Radiant intensity	$I_F = 100\text{ mA}$ , $t_p = 20\text{ ms}$	TSHA6200	$I_e$	25	40	125	mW/sr
		TSHA6201	$I_e$	30	50	125	mW/sr
		TSHA6202	$I_e$	36	60	125	mW/sr
		TSHA6203	$I_e$	50	65	125	mW/sr
	$I_F = 1\text{ A}$ , $t_p = 100\text{ }\mu\text{s}$	TSHA6200	$I_e$	200	330		mW/sr
		TSHA6201	$I_e$	260	400		mW/sr
		TSHA6202	$I_e$	330	460		mW/sr
		TSHA6203	$I_e$	400	530		mW/sr
Radiant power	$I_F = 100\text{ mA}$ , $t_p = 20\text{ ms}$	TSHA6200	$\phi_e$		22		mW
		TSHA6201	$\phi_e$		23		mW
		TSHA6202	$\phi_e$		24		mW
		TSHA6203	$\phi_e$		25		mW

**BASIC CHARACTERISTICS** ( $T_{amb} = 25\text{ }^{\circ}\text{C}$ , unless otherwise specified)

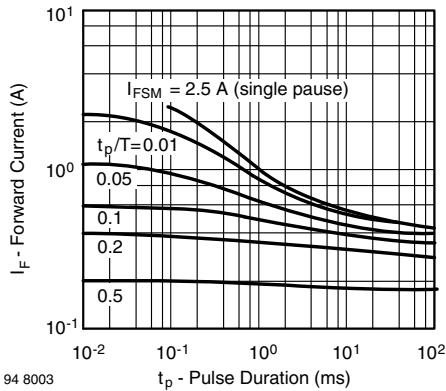

Fig. 3 - Pulse Forward Current vs. Pulse Duration

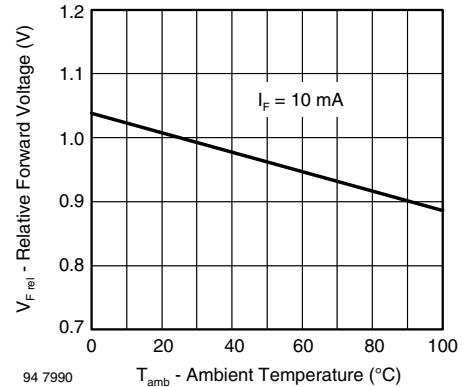

Fig. 5 - Relative Forward Voltage vs. Ambient Temperature

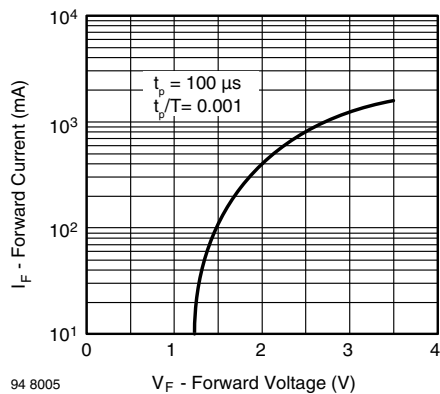

Fig. 4 - Forward Current vs. Forward Voltage

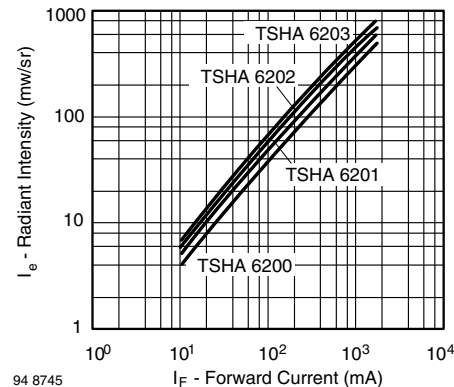

Fig. 6 - Radiant Intensity vs. Forward Current

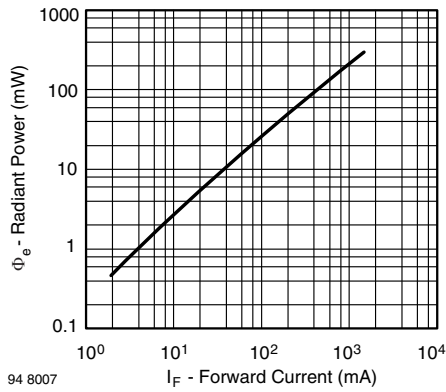

Fig. 7 - Radiant Power vs. Forward Current

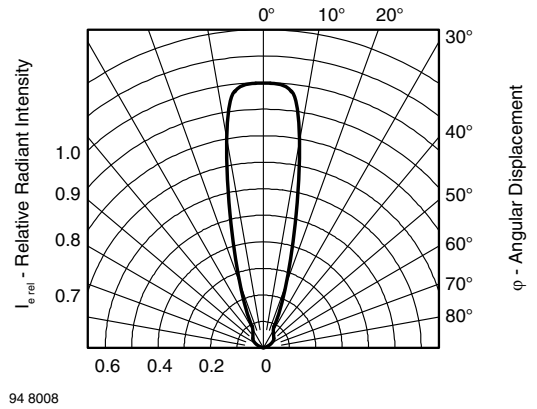

Fig. 10 - Relative Radiant Intensity vs. Angular Displacement

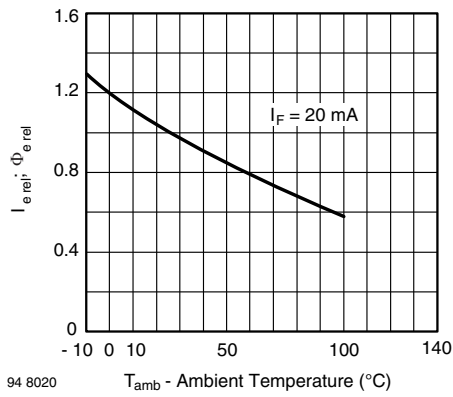

Fig. 8 - Relative Radiant Intensity/Power vs. Ambient Temperature

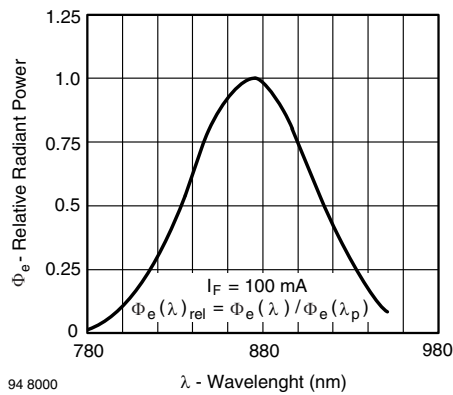
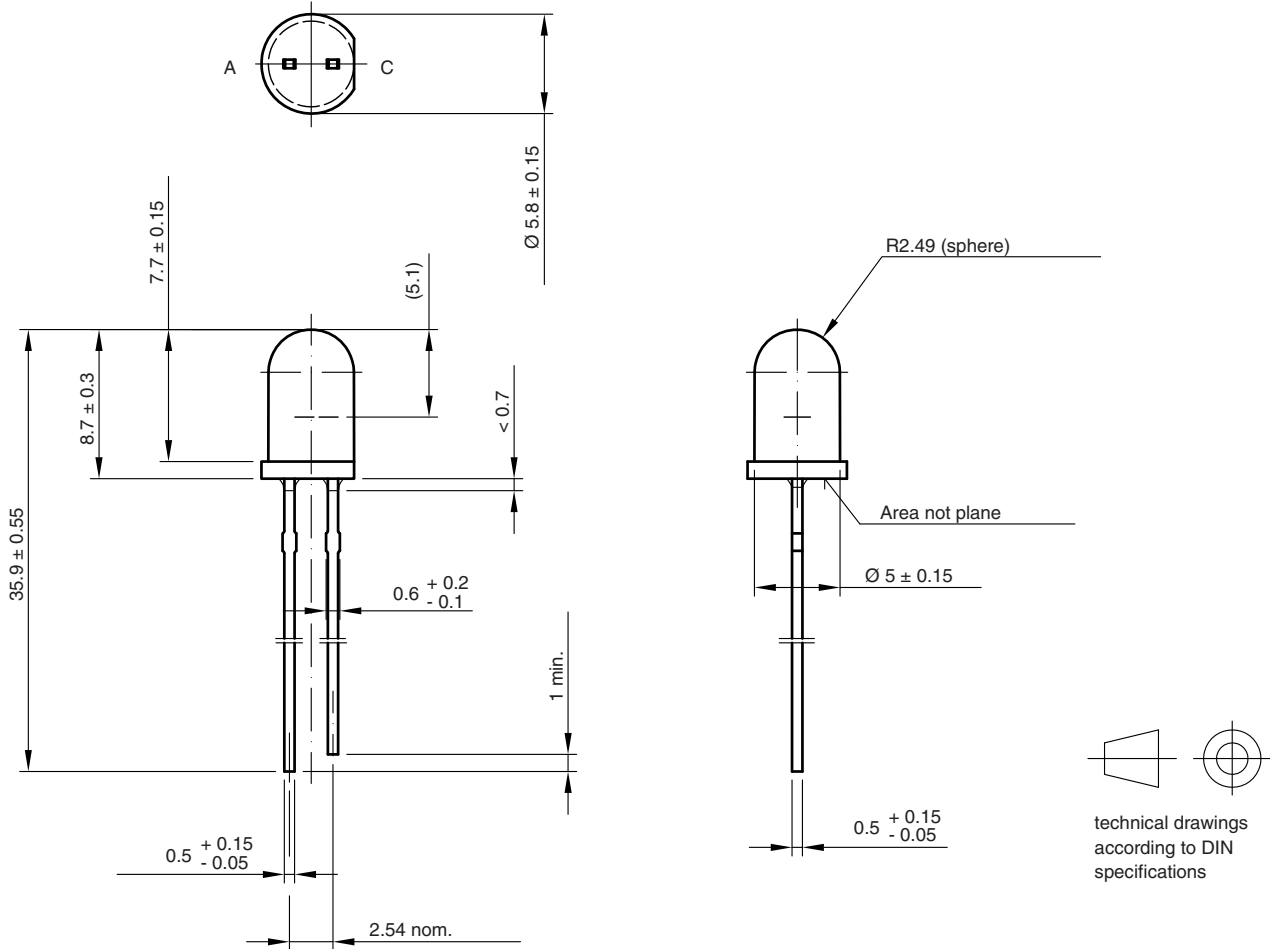

Fig. 9 - Relative Radiant Power vs. Wavelength



## PACKAGE DIMENSIONS in millimeters



Drawing-No.: 6.544-5259.04-4  
 Issue: 8; 19.05.09  
 96 12125



## Disclaimer

ALL PRODUCT, PRODUCT SPECIFICATIONS AND DATA ARE SUBJECT TO CHANGE WITHOUT NOTICE TO IMPROVE RELIABILITY, FUNCTION OR DESIGN OR OTHERWISE.

Vishay Intertechnology, Inc., its affiliates, agents, and employees, and all persons acting on its or their behalf (collectively, "Vishay"), disclaim any and all liability for any errors, inaccuracies or incompleteness contained in any datasheet or in any other disclosure relating to any product.

Vishay makes no warranty, representation or guarantee regarding the suitability of the products for any particular purpose or the continuing production of any product. To the maximum extent permitted by applicable law, Vishay disclaims (i) any and all liability arising out of the application or use of any product, (ii) any and all liability, including without limitation special, consequential or incidental damages, and (iii) any and all implied warranties, including warranties of fitness for particular purpose, non-infringement and merchantability.

Statements regarding the suitability of products for certain types of applications are based on Vishay's knowledge of typical requirements that are often placed on Vishay products in generic applications. Such statements are not binding statements about the suitability of products for a particular application. It is the customer's responsibility to validate that a particular product with the properties described in the product specification is suitable for use in a particular application. Parameters provided in datasheets and / or specifications may vary in different applications and performance may vary over time. All operating parameters, including typical parameters, must be validated for each customer application by the customer's technical experts. Product specifications do not expand or otherwise modify Vishay's terms and conditions of purchase, including but not limited to the warranty expressed therein.

Hyperlinks included in this datasheet may direct users to third-party websites. These links are provided as a convenience and for informational purposes only. Inclusion of these hyperlinks does not constitute an endorsement or an approval by Vishay of any of the products, services or opinions of the corporation, organization or individual associated with the third-party website. Vishay disclaims any and all liability and bears no responsibility for the accuracy, legality or content of the third-party website or for that of subsequent links.

Except as expressly indicated in writing, Vishay products are not designed for use in medical, life-saving, or life-sustaining applications or for any other application in which the failure of the Vishay product could result in personal injury or death. Customers using or selling Vishay products not expressly indicated for use in such applications do so at their own risk. Please contact authorized Vishay personnel to obtain written terms and conditions regarding products designed for such applications.

No license, express or implied, by estoppel or otherwise, to any intellectual property rights is granted by this document or by any conduct of Vishay. Product names and markings noted herein may be trademarks of their respective owners.