

TPS715 50-mA, 24-V, 3.2- μ A Quiescent Current, Low-Dropout Linear Regulator

1 Features

- Input voltage range:
 - 2.5 V to 24 V (30 V max for new chip only)
- Available output voltage options:
 - Fixed: 1.8 V to 5 V
 - Adjustable: 1.205 V to 15 V
- Output current: Up to 50 mA
- Very low I_Q : 3.2 μ A at 50-mA load current
- Stable with output capacitor $\geq 0.47 \mu$ F
- Overcurrent protection
- Package: 5-pin SC70 (DCK)
- Operating junction temperature: -40°C to $+125^\circ\text{C}$
- For an 80-mA rated current and higher power package, see the [TPS715A](#)

2 Applications

- [Home and building automation](#)
- [Retail automation and payment](#)
- [Grid infrastructure](#)
- [Medical applications](#)
- [Lighting applications](#)

3 Description

The TPS715 low-dropout (LDO) linear voltage regulator is low quiescent current device that offers the benefits of a wide input voltage range and low-power operation in miniaturized packaging. Thus, the TPS715 is designed for battery-powered applications and as a power-management attachment to low-power microcontrollers.

The TPS715 is available in both fixed and adjustable versions. For more flexibility or higher output voltages, the adjustable version uses feedback resistors to set the output voltage from 1.205 V to 15 V. The TPS715 LDOs support a low dropout of typically 415 mV at 50 mA of load current. The low quiescent current (3.2 μ A typically) is stable over the entire range of output load current (0 mA to 50 mA). The TPS715 also features an internal soft-start to lower the inrush current. The built-in overcurrent limit helps protect the regulator in the event of a load short or fault.

Package Information⁽¹⁾

| PART NUMBER | PACKAGE | BODY SIZE (NOM) |
|-------------|---------------|--------------------------|
| TPS715 | DCK (SC70, 5) | 2.00 mm \times 1.25 mm |

(1) For all available packages, see the orderable addendum at the end of the data sheet.

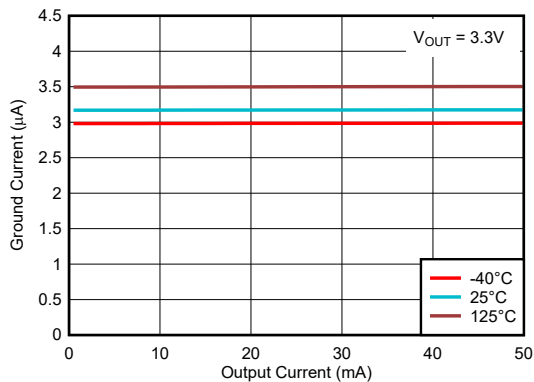
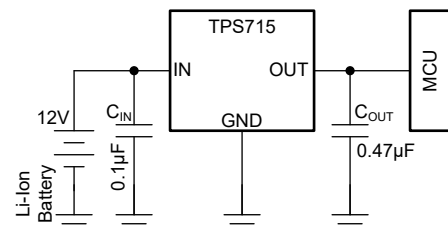

Figure 3-1. Quiescent Current vs Load Current for TPS715xx (New Chip Only)



Typical Application Schematic



Table of Contents

| | | | |
|--|----|--|----|
| 1 Features | 1 | 8 Application and Implementation | 14 |
| 2 Applications | 1 | 8.1 Application Information..... | 14 |
| 3 Description | 1 | 8.2 Typical Application..... | 14 |
| 4 Revision History | 2 | 8.3 Best Design Practices..... | 19 |
| 5 Pin Configuration and Functions | 4 | 8.4 Power Supply Recommendations..... | 19 |
| 6 Specifications | 5 | 8.5 Layout..... | 19 |
| 6.1 Absolute Maximum Ratings..... | 5 | 9 Device and Documentation Support | 21 |
| 6.2 ESD Ratings..... | 5 | 9.1 Device Support..... | 21 |
| 6.3 Recommended Operating Conditions..... | 5 | 9.2 Documentation Support..... | 21 |
| Thermal Information..... | 6 | 9.3 Receiving Notification of Documentation Updates..... | 21 |
| 6.4 Electrical Characteristics..... | 7 | 9.4 Support Resources..... | 21 |
| 6.5 Typical Characteristics..... | 8 | 9.5 Trademarks..... | 21 |
| 7 Detailed Description | 11 | 9.6 Electrostatic Discharge Caution..... | 22 |
| 7.1 Overview..... | 11 | 9.7 Glossary..... | 22 |
| 7.2 Functional Block Diagrams..... | 11 | 10 Mechanical, Packaging, and Orderable Information | 22 |
| 7.3 Feature Description..... | 12 | | |
| 7.4 Device Functional Modes..... | 13 | | |

4 Revision History

NOTE: Page numbers for previous revisions may differ from page numbers in the current version.

| Changes from Revision S (August 2022) to Revision T (December 2022) | Page |
|---|------|
| • Added information for M3 devices (new chip information) to document..... | 1 |
| • Changed <i>Features</i> section: changed adjustable output voltage options, changed <i>Specified junction temperature</i> to <i>Operating junction temperature</i> , and reordered <i>Features</i> bullets..... | 1 |
| • Added <i>Quiescent Current vs Load Current</i> curve to front page..... | 1 |
| • Deleted low power level discussion from <i>Description</i> section..... | 1 |
| • Changed <i>Typical Application Schematic</i> figure..... | 1 |
| • Changed <i>Pin Functions</i> table: changed <i>Description</i> column and added footnote..... | 4 |
| • Added condition statement and characterization conditions plots to <i>Typical Characteristics</i> section..... | 8 |
| • Changed curve titles in <i>Typical Characteristics</i> section to distinguish between new and legacy chips..... | 8 |
| • Changed block diagrams in <i>Functional Block Diagrams</i> section..... | 11 |
| • Changed <i>Low Quiescent Current</i> section and title..... | 12 |
| • Deleted thermal shutdown discussion from <i>Current Limit</i> section..... | 12 |
| • Changed third bullet in <i>Normal Operation</i> section..... | 13 |
| • Changed <i>Application Information</i> section..... | 14 |
| • Changed <i>Typical Application</i> section..... | 14 |
| • Changed output operating voltage range from 1.2 V to 15 V to 1.205 V to 15 V in <i>Setting VOUT for the TPS71501 Adjustable LDO</i> | 14 |
| • Added reverse current limit discussion to <i>Reverse Current</i> section..... | 15 |
| • Changed <i>Application Curves</i> section | 18 |
| • Deleted sentence stating <i>This input supply must be well regulated</i> from <i>Power Supply Recommendations</i> section..... | 19 |
| • Changed <i>Example Layout for the TPS71501DCK</i> figure..... | 20 |
| • Changed <i>Device Nomenclature</i> table..... | 21 |

Changes from Revision R (February 2015) to Revision S (August 2022)

Page

| | |
|---|----|
| • Updated the numbering format for tables, figures, and cross-references throughout the document..... | 1 |
| • Changed document title..... | 1 |
| • Changed <i>Features</i> section..... | 1 |
| • Changed <i>Applications</i> section..... | 1 |
| • Changed <i>Description</i> section..... | 1 |
| • Changed descriptions of FB and NC pins in <i>Pin Functions</i> table, split fixed and adjustable pin outs apart | 4 |
| • Added new chip specific plots to <i>Typical Characteristics</i> section..... | 8 |
| • Changed <i>Overview</i> section..... | 11 |
| • Changed block diagrams in <i>Functional Block Diagrams</i> section..... | 11 |
| • Changed <i>Low Quiescent Current</i> section and title..... | 12 |
| • Changed <i>Dropout Voltage (V_{DO})</i> section..... | 12 |
| • Deleted <i>Disabled</i> row from <i>Device Functional Mode Comparison</i> table..... | 13 |
| • Changed <i>Dropout Operation</i> section..... | 13 |
| • Changed <i>External Capacitor Requirements</i> section..... | 15 |
| • Added <i>Input and Output Capacitor Requirements</i> section..... | 15 |
| • Changed <i>Reverse Current</i> section..... | 15 |
| • Changed output voltage value when no C _{FF} is used from 0.8 V to 1.205 V | 16 |
| • Added <i>Power Dissipation (P_D)</i> section..... | 16 |
| • Added new chip specific plots to <i>Application Curves</i> section..... | 18 |
| • Added second row and deleted second footnote from <i>Device Nomenclature</i> table..... | 21 |

5 Pin Configuration and Functions

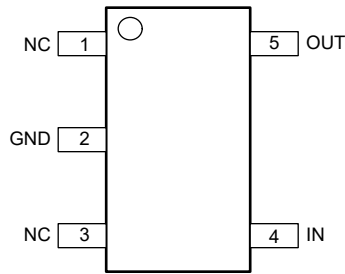

Figure 5-1. DCK Package (Fixed), 5-Pin SC70 (Top View)

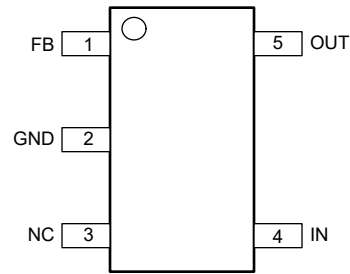

Figure 5-2. DCK Package (Adjustable), 5-Pin SC70 (Top View)

Table 5-1. Pin Functions

| NAME | PIN | | TYPE | DESCRIPTION |
|------|-------|------------|------|--|
| | FIXED | ADJUSTABLE | | |
| FB | — | 1 | I | In the adjustable configuration, this pin sets the output voltage with the help of the feedback divider. |
| GND | 2 | 2 | — | Ground pin. |
| IN | 4 | 4 | I | Input supply pin. A capacitor with a value of 0.1 μF or larger is recommended from this pin to ground. See the Input and Output Capacitor Requirements section for more information. |
| NC | 1, 3 | 3 | — | No connect pin. This pin is not connected internally. Connect this pin to ground for best thermal performance or leave floating. |
| OUT | 5 | 5 | O | Output of the regulator. A capacitor with a value of 1 μF or larger is required from this pin to ground. ⁽¹⁾ See the Input and Output Capacitor Requirements section for more information. |

(1) The nominal output capacitance must be greater than 0.47 μF . Throughout this document, the nominal derating on these capacitors is 50%. Make sure that the effective capacitance at the pin is greater than 0.47 μF .

6 Specifications

6.1 Absolute Maximum Ratings

over operating temperature range (unless otherwise noted)^{(1) (2)}

| | | MIN | MAX | UNIT |
|-------------|--|--------------------|---|------|
| Voltage | V _{IN} (for legacy chip only) | -0.3 | 24 | V |
| | V _{IN} (for new chip only) | -0.3 | 30 | |
| | V _{OUT} (for legacy chip only) | -0.3 | 16.5 | |
| | V _{OUT} (for fixed output new chip only) | -0.3 | 2 X V _{OUT(typ)} or V _{IN} + 0.3V or 5.5V (whichever is lower) | |
| Voltage | V _{OUT} (for adjustable output new chip only) | -0.3 | V _{IN} + 0.3 | V |
| | V _{FB} (for adjustable output new chip only) | | 2.4 | |
| | V _{FB} (for adjustable output legacy chip only) | -0.3 | 4.5 | |
| Current | Peak output current | Internally limited | | |
| Temperature | Junction, T _J | -40 | 150 | °C |
| | Storage, T _{stg} | -65 | 150 | |

- Stresses beyond those listed under *Absolute Maximum Ratings* may cause permanent damage to the device. These are stress ratings only, which do not imply functional operation of the device at these or any other conditions beyond those indicated under *Recommended Operating Conditions*. Exposure to absolute-maximum-rated conditions for extended periods may affect device reliability.
- All voltage values are with respect to network ground terminal.

6.2 ESD Ratings

| | | VALUE | UNIT |
|--------------------|-------------------------|--|-------|
| V _(ESD) | Electrostatic discharge | Human body model (HBM), per ANSI/ESDA/JEDEC JS-001, all pins ⁽¹⁾ | ±2000 |
| | | Charged device model (CDM), per JEDEC specification JESD22-C101, all pins ⁽²⁾ | ±500 |

- JEDEC document JEP155 states that 500-V HBM allows safe manufacturing with a standard ESD control process.
- JEDEC document JEP157 states that 250-V CDM allows safe manufacturing with a standard ESD control process.

6.3 Recommended Operating Conditions

over operating free-air temperature range (unless otherwise noted)⁽¹⁾

| | | MIN | NOM | MAX | UNIT |
|------------------|---|-------|-------|-----|------|
| V _{IN} | Input supply voltage | 2.5 | | 24 | V |
| V _{OUT} | Output voltage | 1.205 | | 15 | |
| I _{OUT} | Output current | 0 | | 50 | mA |
| C _{IN} | Input capacitor ⁽²⁾ | 0 | 0.047 | | μF |
| C _{OUT} | Output capacitor (for legacy chip only) | 0.47 | 1 | | |
| | Output capacitor (for new chip only) ⁽³⁾ | 1 | | | |
| T _J | Operating junction temperature | -40 | | 125 | °C |

- All voltages are with respect to GND.
- An input capacitor is not required for LDO stability. However, an input capacitor with an effective value of 0.047 μF is recommended to counteract the effect of source resistance and inductance, which may in some cases cause symptoms of system level instability such as ringing or oscillation, especially in the presence of load transients.
- All capacitor values are assumed to derate to 50% of the nominal capacitor value. Maintain an effective output capacitance of 0.47 μF minimum for the stability.

Thermal Information

| THERMAL METRIC ⁽¹⁾ | | Legacy Chip | New Chip | UNIT |
|-------------------------------|--|-------------|-------------|------|
| | | DCK (SC-70) | DCK (SC-70) | |
| | | 5 PINS | 5 PINS | |
| $R_{\theta JA}$ | Junction-to-ambient thermal resistance | 253.8 | 195.7 | °C/W |
| $R_{\theta JC(top)}$ | Junction-to-case (top) thermal resistance | 73.7 | 88.2 | °C/W |
| $R_{\theta JB}$ | Junction-to-board thermal resistance | 84.6 | 40.7 | °C/W |
| ψ_{JT} | Junction-to-top characterization parameter | 1.1 | 11.2 | °C/W |
| ψ_{JB} | Junction-to-board characterization parameter | 83.9 | 40.5 | °C/W |

- (1) For more information about traditional and new thermal metrics, see the [Semiconductor and IC package thermal metrics](#) application report.

6.4 Electrical Characteristics

over operating junction temperature range ($T_J = -40^\circ\text{C}$ to 125°C), $V_{IN} = V_{OUT(nom)} + 1\text{ V}$, $I_{OUT} = 1\text{ mA}$, and $C_{OUT} = 1\text{ }\mu\text{F}$ (unless otherwise noted); typical values are at $T_J = 25^\circ\text{C}$

| PARAMETER | | TEST CONDITIONS | MIN | TYP | MAX | UNIT |
|-----------------------------------|---|---|-------|-----|-----|------------------|
| V_{IN} | Input voltage ⁽¹⁾ | $I_O = 10\text{ mA}$ | 2.5 | | 24 | V |
| | | $I_O = 50\text{ mA}$ | 3 | | 24 | |
| V_{OUT} | Output voltage range (TPS71501) | | 1.205 | | 15 | V |
| | Output voltage accuracy ^{(1) (2)} | $V_{OUT} + 1\text{ V} \leq V_{IN} \leq 24\text{ V}$, $100\text{ }\mu\text{A} \leq I_{OUT} \leq 50\text{ mA}$ | -4 | | 4 | % |
| I_{GND} | Ground pin current (legacy chip) ⁽³⁾ | $0 \leq I_{OUT} \leq 50\text{ mA}$, $T_J = -40^\circ\text{C}$ to 85°C | | 3.2 | 4.2 | μA |
| | | $0\text{ mA} \leq I_{OUT} \leq 50\text{ mA}$ | | 3.2 | 4.8 | |
| | | $0\text{ mA} \leq I_{OUT} \leq 50\text{ mA}$, $V_{IN} = 24\text{ V}$ | | | 5.8 | |
| | Ground pin current (new chip) ⁽³⁾ | $0 \leq I_{OUT} \leq 50\text{ mA}$, $T_J = -40^\circ\text{C}$ to 85°C | | 3.2 | 4.1 | |
| | | $0\text{ mA} \leq I_{OUT} \leq 50\text{ mA}$ | | 3.2 | 4.3 | |
| | | $0\text{ mA} \leq I_{OUT} \leq 50\text{ mA}$, $V_{IN} = 24\text{ V}$ | | | 4.5 | |
| $\Delta V_{OUT} (\Delta I_{OUT})$ | Load regulation | $I_{OUT} = 100\text{ }\mu\text{A}$ to 50 mA | | 22 | | mV |
| $\Delta V_{OUT} (\Delta V_{IN})$ | Output voltage line regulation (legacy chip) ⁽¹⁾ | $V_{OUT(NOM)} + 1\text{ V} \leq V_{IN} \leq 24\text{ V}$ | | 20 | 60 | mV |
| | Output voltage line regulation (new chip) ⁽¹⁾ | $V_{OUT(NOM)} + 1\text{ V} \leq V_{IN} \leq 24\text{ V}$ | | 20 | 22 | |
| V_n | Output noise voltage (legacy chip) ⁽⁴⁾ | $\text{BW} = 200\text{ Hz}$ to 100 kHz , $C_{OUT} = 10\text{ }\mu\text{F}$, $I_{OUT} = 50\text{ mA}$ | | 575 | | μVrms |
| | Output noise voltage (new chip) ⁽⁴⁾ | $\text{BW} = 200\text{ Hz}$ to 100 kHz , $C_{OUT} = 10\text{ }\mu\text{F}$, $I_{OUT} = 50\text{ mA}$ | | 425 | | |
| I_{CL} | Output current limit (legacy chip) | $V_{OUT} = 0\text{ V}$, $V_{IN} \geq 3.5\text{ V}$ | 125 | | 750 | mA |
| | | $V_{OUT} = 0\text{ V}$, $V_{IN} < 3.5\text{ V}$ | 90 | | 750 | |
| | Output current limit (new chip) | $V_{OUT} = 0\text{ V}$, $V_{IN} \geq 3.5\text{ V}$ | 125 | | 350 | |
| | | $V_{OUT} = 0\text{ V}$, $V_{IN} < 3.5\text{ V}$ | 90 | | 350 | |
| PSRR | Power-supply ripple rejection | $f = 100\text{ kHz}$, $C_{OUT} = 10\text{ }\mu\text{F}$ | | 60 | | dB |
| V_{DO} | Dropout voltage (legacy chip) | $I_{OUT} = 50\text{ mA}$, $V_{IN} = V_{OUT(nom)} - 0.1\text{ V}$ | | 415 | 750 | mV |
| | Dropout voltage (new chip) | V | | 415 | 525 | |

- (1) Minimum $V_{IN} = V_{OUT} + V_{DO}$ or the value shown for *Input voltage* in this table, whichever is greater.
- (2) For adjustable device, output accuracy excludes the tolerance and mismatch associated with external resistors used for setting up the output voltage level.
- (3) This device employs a leakage null control circuit. This circuit is active only if output current is less than pass FET leakage current. The circuit is typically active when output load is less than $5\text{ }\mu\text{A}$, V_{IN} is greater than 18 V , and die temperature is greater than 100°C .
- (4) See [Device Nomenclature](#) for details about new and legacy chip descriptions

6.5 Typical Characteristics

at operating temperature $T_J = 25^\circ\text{C}$, $V_{IN} = V_{OUT(NOM)} + 1.0\text{ V}$ or 2.5 V (whichever is greater), $I_{OUT} = 1\text{ mA}$, $C_{IN} = 1\ \mu\text{F}$, and $C_{OUT} = 1\ \mu\text{F}$ (unless otherwise noted)

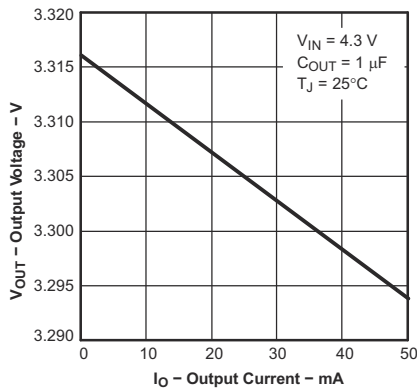

Figure 6-1. Output Voltage vs Output Current for Legacy Chip

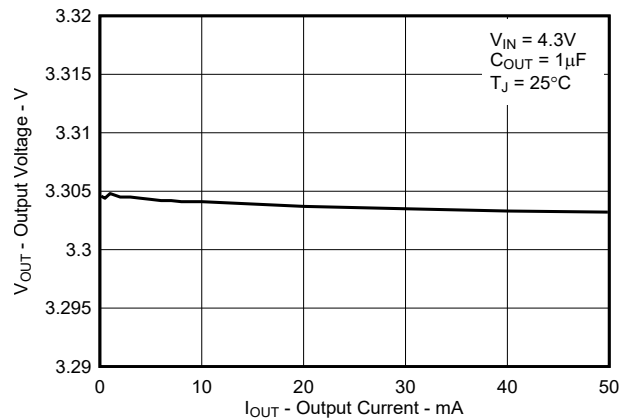

Figure 6-2. Output Voltage vs Output Current for New Chip

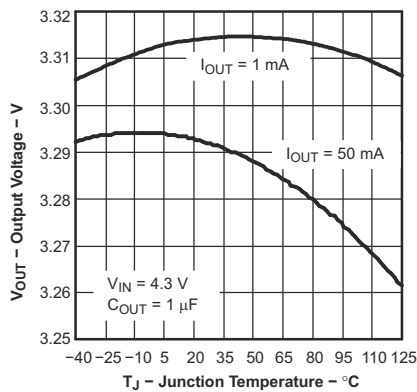

Figure 6-3. Output Voltage vs Junction Temperature for Legacy Chip

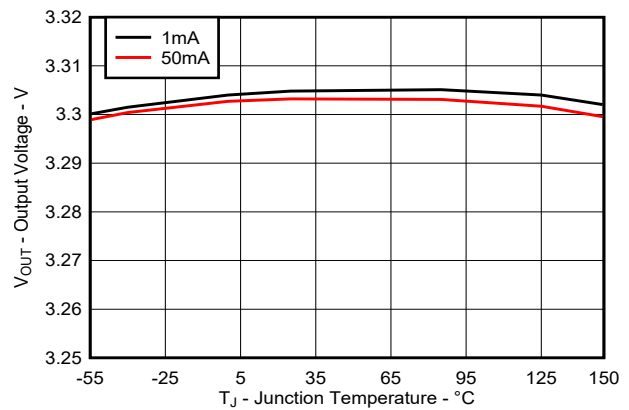

Figure 6-4. Output Voltage vs Junction Temperature for New Chip

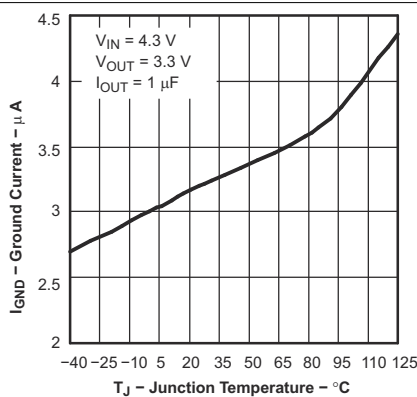

Figure 6-5. Quiescent Current vs Junction Temperature for Legacy Chip

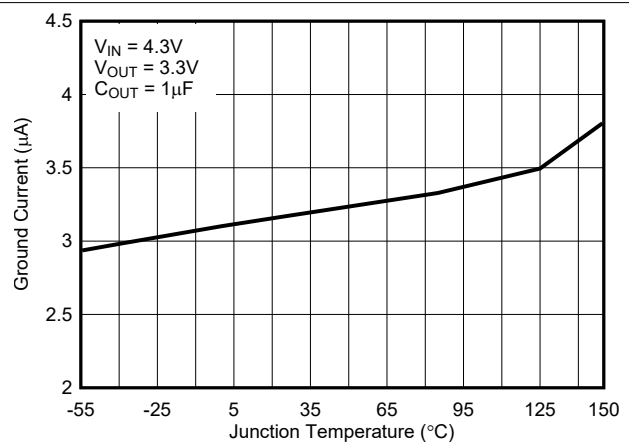

Figure 6-6. Quiescent Current vs Junction Temperature for New Chip

6.5 Typical Characteristics (continued)

at operating temperature $T_J = 25^\circ\text{C}$, $V_{IN} = V_{OUT(NOM)} + 1.0\text{ V}$ or 2.5 V (whichever is greater), $I_{OUT} = 1\text{ mA}$, $C_{IN} = 1\ \mu\text{F}$, and $C_{OUT} = 1\ \mu\text{F}$ (unless otherwise noted)

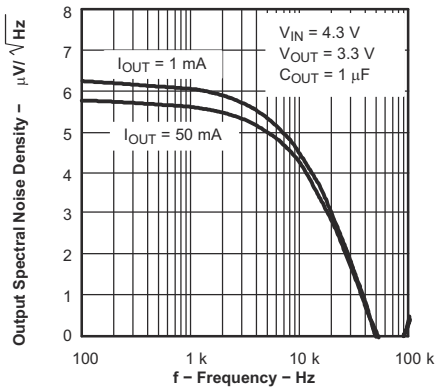

Figure 6-7. Output Voltage Spectral Noise Density vs Frequency for Legacy Chip

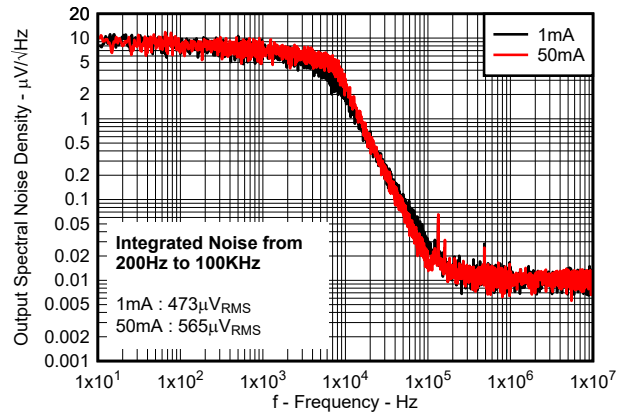

Figure 6-8. Output Voltage Spectral Noise Density vs Frequency for New Chip

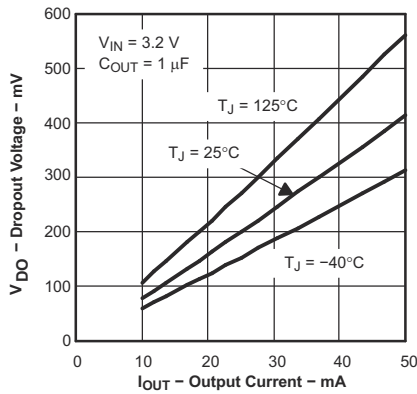

Figure 6-9. Dropout Voltage vs Output Current for Legacy Chip

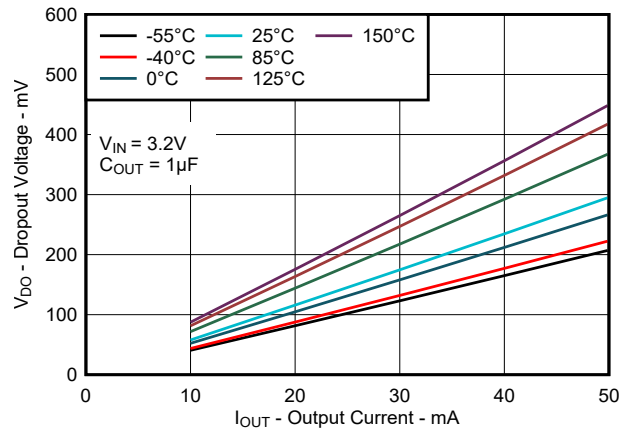

Figure 6-10. Dropout Voltage vs Output Current for New Chip

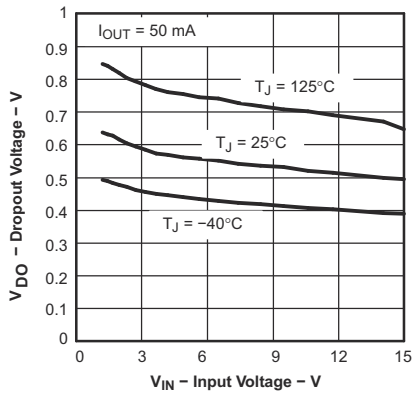

Figure 6-11. TPS71501 Dropout Voltage vs Input Voltage for Legacy Chip

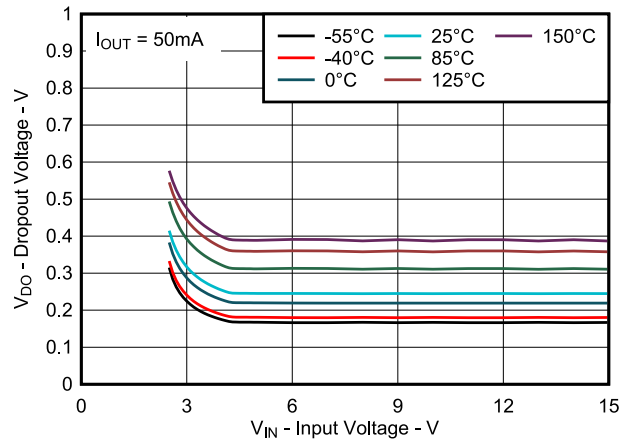

Figure 6-12. TPS71501 Dropout Voltage vs Input Voltage for New Chip

6.5 Typical Characteristics (continued)

at operating temperature $T_J = 25^\circ\text{C}$, $V_{IN} = V_{OUT(\text{NOM})} + 1.0\text{ V}$ or 2.5 V (whichever is greater), $I_{OUT} = 1\text{ mA}$, $C_{IN} = 1\ \mu\text{F}$, and $C_{OUT} = 1\ \mu\text{F}$ (unless otherwise noted)

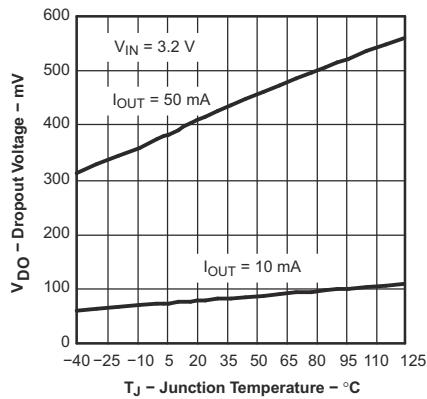

Figure 6-13. Dropout Voltage vs Junction Temperature for Legacy Chip

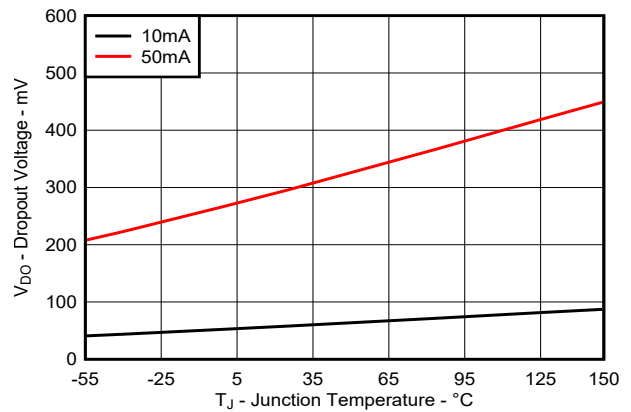

Figure 6-14. Dropout Voltage vs Junction Temperature for New Chip

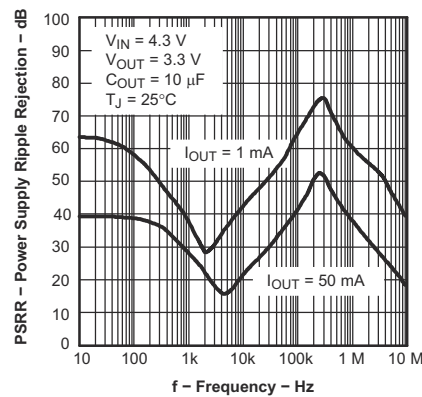

Figure 6-15. Power-Supply Ripple Rejection vs Frequency for Legacy Chip

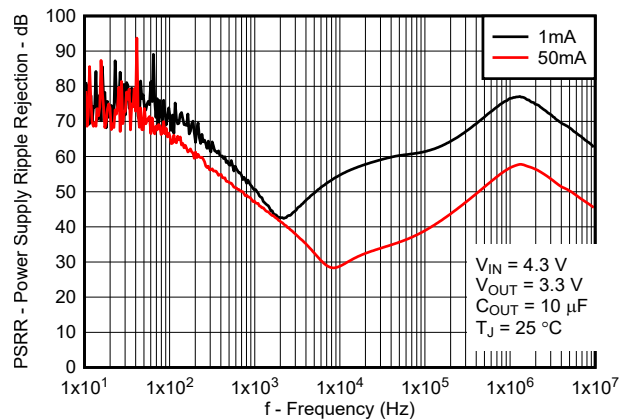

Figure 6-16. Power-Supply Ripple Rejection vs Frequency for New Chip

7 Detailed Description

7.1 Overview

The TPS715 low-dropout regulator (LDO) consumes only 3.2 μA (typ) of quiescent current across the entire output current range, while offering a wide input voltage range and low-dropout voltage in small packaging. The device, which operates over an input range of 2.5 V to 24 V, is stable with any output capacitor greater than or equal to 0.47 μF . The low quiescent current across the complete load current range makes the TPS715 optimal for powering battery-operated applications. The TPS715 has internal soft-start to control inrush current into the output capacitor. This LDO also has overcurrent protection during a load-short or fault condition on the output.

7.2 Functional Block Diagrams

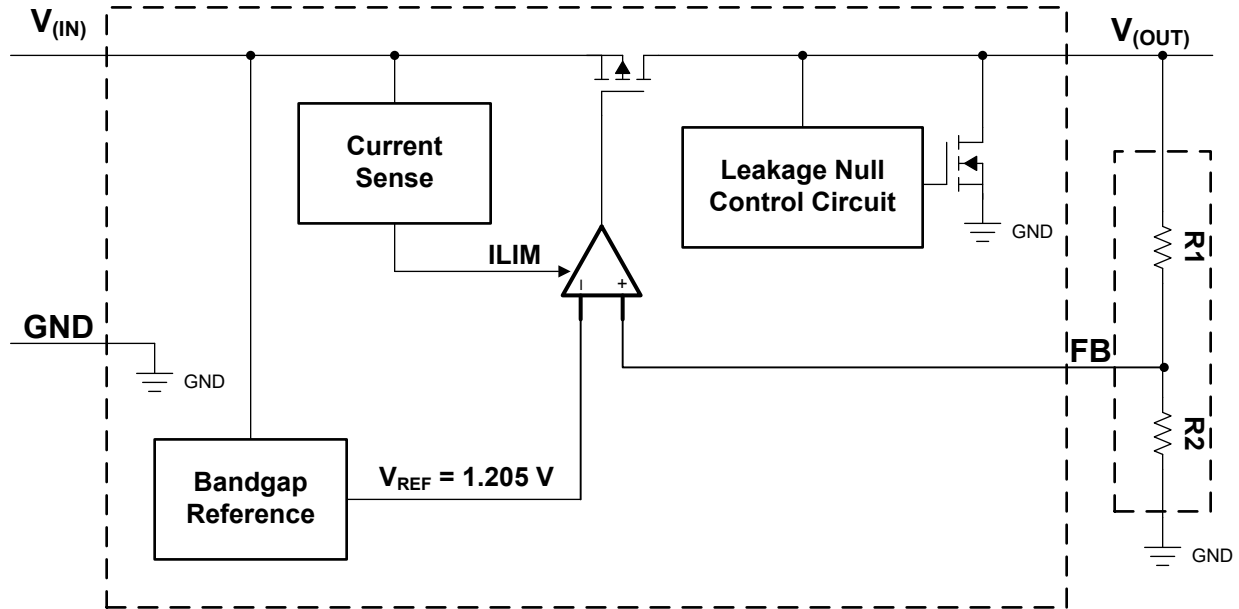

Figure 7-1. Functional Block Diagram—Adjustable Version

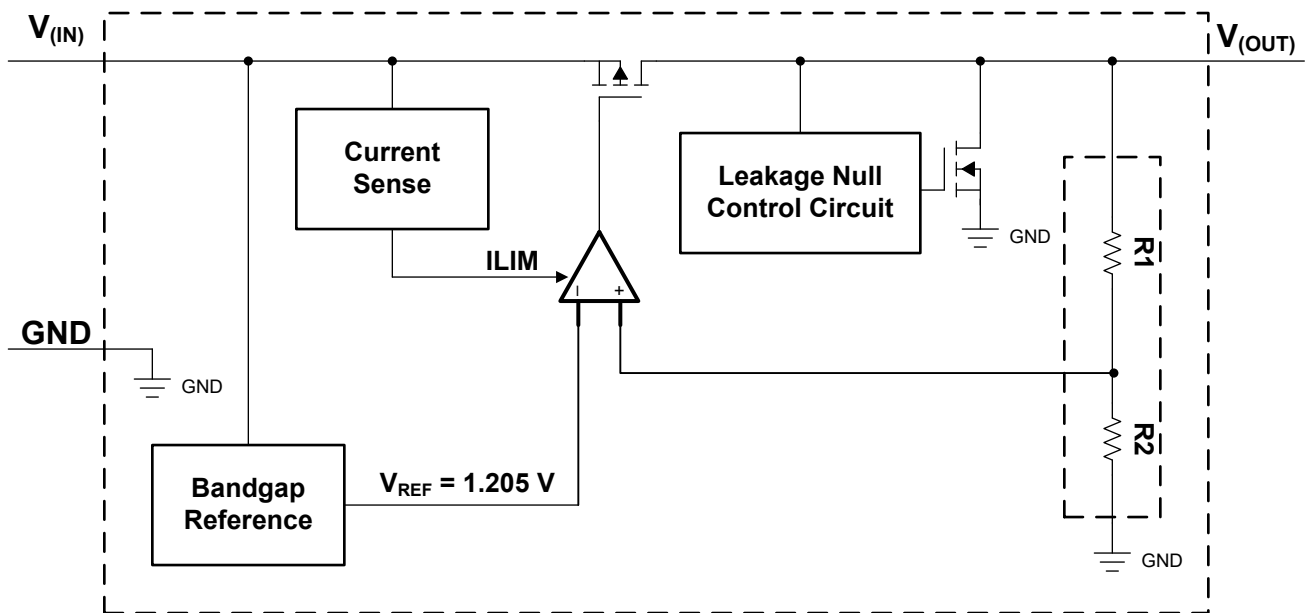

Figure 7-2. Functional Block Diagram—Fixed Version

7.3 Feature Description

7.3.1 Wide Supply Range

This device has an operational input supply range of 2.5 V to 24 V, allowing for a wide range of applications. This wide supply range is designed for applications that have either large transients or high DC voltage supplies.

7.3.2 Low Quiescent Current

This device only requires 3.2 μA (typical) of quiescent current across the complete load current range (0 mA to 50 mA) from -40°C to $+125^\circ\text{C}$.

7.3.3 Dropout Voltage (V_{DO})

Dropout voltage (V_{DO}) is defined as the input voltage minus the output voltage ($V_{\text{IN}} - V_{\text{OUT}}$) at the rated output current (I_{RATED}), where the pass transistor is fully on. I_{RATED} is the maximum I_{OUT} listed in the *Recommended Operating Conditions* table. In dropout operation, the pass transistor is in the ohmic or triode region of operation, and acts as a switch. The dropout voltage indirectly specifies a minimum input voltage greater than the nominal programmed output voltage at which the output voltage is expected to stay in regulation. If the input voltage falls to less than the value required to maintain output regulation, then the output voltage falls as well.

For a CMOS regulator, the dropout voltage is determined by the drain-source, on-state resistance ($R_{\text{DS(ON)}}$) of the pass transistor. Therefore, if the linear regulator operates at less than the rated current, the dropout voltage for that current scales accordingly. Use [Equation 1](#) to calculate the $R_{\text{DS(ON)}}$ of the device.

$$R_{\text{DS(ON)}} = \frac{V_{\text{DO}}}{I_{\text{RATED}}} \quad (1)$$

7.3.4 Current Limit

The device has an internal current limit circuit that protects the regulator during transient high-load current faults or shorting events. The current limit is a brick-wall scheme. In a high-load current fault, the brick-wall scheme limits the output current to the current limit (I_{CL}). I_{CL} is listed in the [Electrical Characteristics](#) table.

The output voltage is not regulated when the device is in current limit. When a current limit event occurs, the device begins to heat up because of the increase in power dissipation. When the device is in brick-wall current limit, the pass transistor dissipates power $[(V_{\text{IN}} - V_{\text{OUT}}) \times I_{\text{CL}}]$. For more information on current limits, see the [Know Your Limits application note](#).

[Figure 7-3](#) shows a diagram of the current limit.

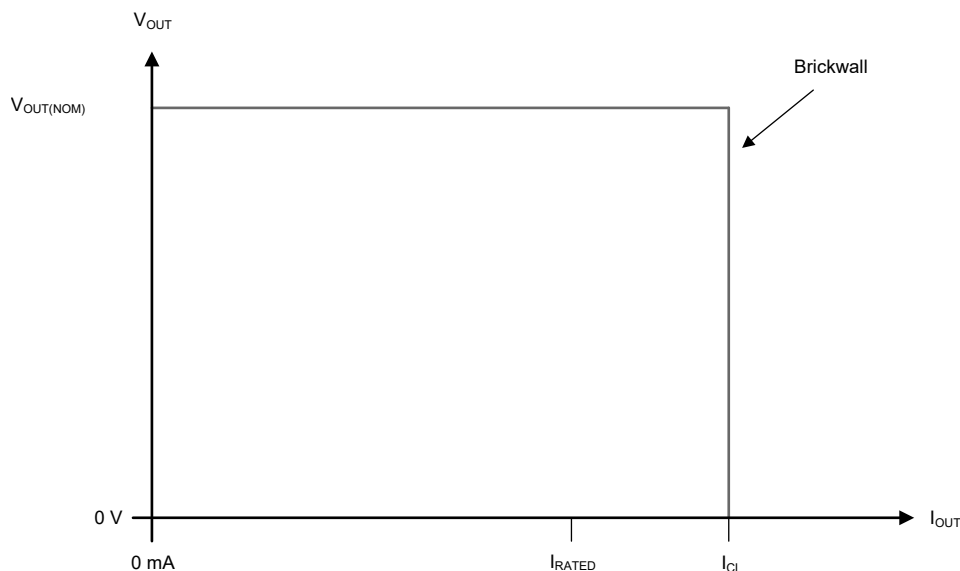

Figure 7-3. Current Limit

7.4 Device Functional Modes

Table 7-1 provides a quick comparison between the normal, dropout, and disabled modes of operation.

Table 7-1. Device Functional Mode Comparison

| OPERATING MODE | PARAMETER | |
|----------------|----------------------------------|--------------------|
| | V_{IN} | I_{OUT} |
| Normal | $V_{IN} > V_{OUT(nom)} + V_{DO}$ | $I_{OUT} < I_{CL}$ |
| Dropout | $V_{IN} < V_{OUT(nom)} + V_{DO}$ | $I_{OUT} < I_{CL}$ |

7.4.1 Normal Operation

The device regulates to the nominal output voltage under the following conditions:

- The input voltage is greater than the nominal output voltage plus the dropout voltage ($V_{OUT(nom)} + V_{DO}$)
- The output current is less than the current limit ($I_{OUT} < I_{CL}$)
- The device junction temperature is greater than -40°C and less than $+125^{\circ}\text{C}$

7.4.2 Dropout Operation

If the input voltage is lower than the nominal output voltage plus the specified dropout voltage, but all other conditions are met for normal operation, the device operates in dropout mode. In this mode, the output voltage tracks the input voltage. During this mode, the transient performance of the device becomes significantly degraded because the pass transistor is in the ohmic or triode region, and acts as a switch. Line or load transients in dropout can result in large output-voltage deviations.

When the device is in a steady dropout state (defined as when the device is in dropout, $V_{IN} < V_{OUT(NOM)} + V_{DO}$, directly after being in a normal regulation state, but *not* during start up), the pass transistor is driven into the ohmic or triode region. When the input voltage returns to a value greater than or equal to the nominal output voltage plus the dropout voltage ($V_{OUT(NOM)} + V_{DO}$), the output voltage can overshoot for a short period of time while the device pulls the pass transistor back into the linear region.

8 Application and Implementation

Note

Information in the following applications sections is not part of the TI component specification, and TI does not warrant its accuracy or completeness. TI's customers are responsible for determining suitability of components for their purposes, as well as validating and testing their design implementation to confirm system functionality.

8.1 Application Information

The TPS715 family of LDO regulators is designed for battery-powered applications and is a good supply for low-power microcontrollers (such as the [MSP430](#)) because of the device family low I_Q performance across load current range. The ultra-low-supply current of the TPS715 device maximizes efficiency at light loads, and the high input voltage range and flexibility of output voltage selection in the adjustable configuration and fixed output levels makes the device an optimal supply for building automation and power tools.

8.2 Typical Application

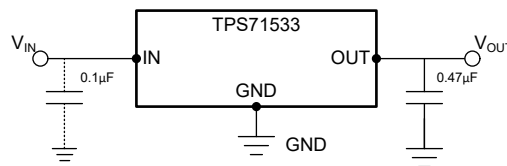

Figure 8-1. Typical Application Circuit (Fixed-Voltage Version)

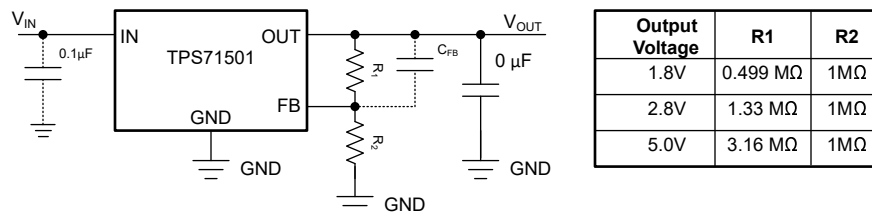

Figure 8-2. TPS71501 Adjustable LDO Regulator Programming

8.2.1 Detailed Design Procedure

8.2.1.1 Setting V_{OUT} for the TPS71501 Adjustable LDO

The TPS715 family contains an adjustable version, the TPS71501, which sets the output voltage using an external resistor divider as shown in [Figure 8-2](#). The output voltage operating range is 1.205 V to 15 V, and is calculated using:

$$V_{OUT} = V_{REF} \times \left(1 + \frac{R1}{R2} \right) \quad (2)$$

where:

- $V_{REF} = 1.205$ V (typical)

Choose resistors R1 and R2 allows approximately 1.5 μA of current through the resistor divider. Lower value resistors can be used for improved noise performance, but consume more power. Avoid higher resistor values because leakage current into or out of FB across R1 / R2 creates an offset voltage that is proportional to V_{OUT} divided by V_{REF} . The recommended design procedure is to choose $R2 = 1\text{ M}\Omega$ to set the divider current at 1.5 μA , and then calculate R1 using [Equation 3](#):

$$R1 = \left(\frac{V_{\text{OUT}}}{V_{\text{REF}}} - 1 \right) \times R2 \quad (3)$$

[Figure 8-2](#) depicts this configuration.

8.2.1.2 External Capacitor Requirements

The device is designed to be stable using low equivalent series resistance (ESR) ceramic capacitors at the input and output. Multilayer ceramic capacitors have become the industry standard for these types of applications and are recommended, but must be used with good judgment. Ceramic capacitors that employ X7R-, X5R-, and C0G-rated dielectric materials provide relatively good capacitive stability across temperature, whereas the use of Y5V-rated capacitors is discouraged because of large variations in capacitance.

Regardless of the ceramic capacitor type selected, the effective capacitance varies with operating voltage and temperature. As a rule of thumb, expect the effective capacitance to decrease by as much as 50%. The input and output capacitors recommended in the *Recommended Operating Conditions* table account for an effective capacitance of approximately 50% of the nominal value.

8.2.1.3 Input and Output Capacitor Requirements

Although an input capacitor is not required for stability, good analog design practice is to connect a capacitor from IN to GND. This capacitor counteracts reactive input sources and improves transient response, input ripple, and PSRR. An input capacitor is recommended if the source impedance is more than 0.5 Ω . A higher value capacitor may be necessary if large, fast rise-time load or line transients are anticipated or if the device is located several inches from the input power source.

Dynamic performance of the device is improved with the use of a large output capacitor. Use an output capacitor within the range specified in the *Recommended Operating Conditions* table for stability.

8.2.1.4 Reverse Current

Excessive reverse current can damage this device. Reverse current flows through the intrinsic body diode of the PMOS pass transistor instead of the normal conducting channel. At high magnitudes, this current flow degrades the long-term reliability of the device.

Conditions where reverse current can occur are outlined in this section, all of which can exceed the absolute maximum rating of $V_{\text{OUT}} \leq V_{\text{IN}} + 0.3\text{ V}$. These conditions are:

- If the device has a large C_{OUT} and the input supply collapses with little or no load current
- The output is biased when the input supply is not established
- The output is biased above the input supply

If reverse current flow is expected in the application, external protection is recommended to protect the device. Reverse current is not limited in the device, so external limiting is required if extended reverse voltage operation is anticipated. Limit reverse current to 5% or less of the rated output current of the device in the event this current cannot be avoided.

Figure 8-3 shows one approach for protecting the device.

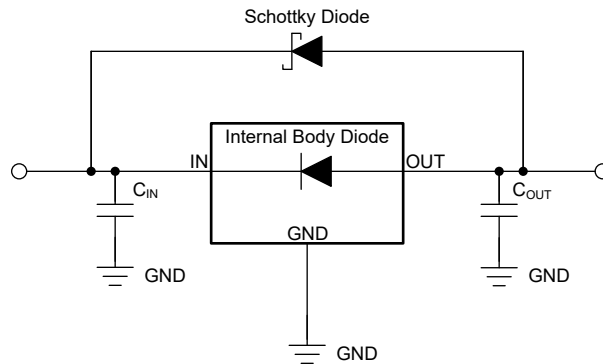

Figure 8-3. Example Circuit for Reverse Current Protection Using a Schottky Diode

8.2.1.5 Feed-Forward Capacitor (C_{FF})

For the adjustable-voltage version device, a feed-forward capacitor (C_{FF}) can be connected from the OUT pin to the FB pin. C_{FF} improves transient, noise, and PSRR performance, but is not required for regulator stability. Recommended C_{FF} values are listed in the *Recommended Operating Conditions* table. A higher capacitance C_{FF} can be used; however, the start-up time increases. For a detailed description of C_{FF} tradeoffs, see the [Pros and Cons of Using a Feedforward Capacitor with a Low-Dropout Regulator application note](#).

C_{FF} and R_1 form a zero in the loop gain at frequency f_z , while C_{FF} , R_1 , and R_2 form a pole in the loop gain at frequency f_p . C_{FF} zero and pole frequencies can be calculated from the following equations:

$$f_z = 1 / (2 \times \pi \times C_{FF} \times R_1) \quad (4)$$

$$f_p = 1 / (2 \times \pi \times C_{FF} \times (R_1 \parallel R_2)) \quad (5)$$

$C_{FF} \geq 10$ pF is required for stability if the feedback divider current is less than 5 μ A. Equation 6 calculates the feedback divider current.

$$I_{FB_Divider} = V_{OUT} / (R_1 + R_2) \quad (6)$$

To avoid start-up time increases from C_{FF} , limit the product $C_{FF} \times R_1 < 50$ μ s.

For an output voltage of 1.205 V with the FB pin tied to the OUT pin, no C_{FF} is used.

8.2.1.6 Power Dissipation (P_D)

Circuit reliability requires consideration of the device power dissipation, location of the circuit on the printed circuit board (PCB), and correct sizing of the thermal plane. The PCB area around the regulator must have few or no other heat-generating devices that cause added thermal stress.

To first-order approximation, power dissipation in the regulator depends on the input-to-output voltage difference and load conditions. The following equation calculates power dissipation (P_D).

$$P_D = (V_{IN} - V_{OUT}) \times I_{OUT} \quad (7)$$

Note

Power dissipation can be minimized, and therefore greater efficiency can be achieved, by correct selection of the system voltage rails. For the lowest power dissipation, use the minimum input voltage required for correct output regulation.

For devices with a thermal pad, the primary heat conduction path for the device package is through the thermal pad to the PCB. Solder the thermal pad to a copper pad area under the device. This pad area must contain an array of plated vias that conduct heat to additional copper planes for increased heat dissipation.

The maximum power dissipation determines the maximum allowable ambient temperature (T_A) for the device. According to the following equation, power dissipation and junction temperature are most often related by the junction-to-ambient thermal resistance ($R_{\theta JA}$) of the combined PCB and device package and the temperature of the ambient air (T_A).

$$T_J = T_A + (R_{\theta JA} \times P_D) \quad (8)$$

Thermal resistance ($R_{\theta JA}$) is highly dependent on the heat-spreading capability built into the particular PCB design, and therefore varies according to the total copper area, copper weight, and location of the planes. The junction-to-ambient thermal resistance listed in the *Thermal Information* table is determined by the JEDEC standard PCB and copper-spreading area, and is used as a relative measure of package thermal performance.

8.2.1.7 Estimating Junction Temperature

The JEDEC standard now recommends the use of psi (Ψ) thermal metrics to estimate the junction temperatures of the linear regulator when in-circuit on a typical PCB board application. These metrics are not thermal resistance parameters and instead offer a practical and relative way to estimate junction temperature. These psi metrics are determined to be significantly independent of the copper area available for heat-spreading. The *Thermal Information* table lists the primary thermal metrics, which are the junction-to-top characterization parameter (ψ_{JT}) and junction-to-board characterization parameter (ψ_{JB}). These parameters provide two methods for calculating the junction temperature (T_J), as described in the following equations. Use the junction-to-top characterization parameter (ψ_{JT}) with the temperature at the center-top of device package (T_T) to calculate the junction temperature. Use the junction-to-board characterization parameter (ψ_{JB}) with the PCB surface temperature 1 mm from the device package (T_B) to calculate the junction temperature.

$$T_J = T_T + \psi_{JT} \times P_D \quad (9)$$

where:

- P_D is the dissipated power
- T_T is the temperature at the center-top of the device package

$$T_J = T_B + \psi_{JB} \times P_D \quad (10)$$

where:

- T_B is the PCB surface temperature measured 1 mm from the device package and centered on the package edge

For detailed information on the thermal metrics and how to use them, see the [Semiconductor and IC Package Thermal Metrics application note](#).

8.2.2 Application Curves

at operating temperature $T_J = 25^\circ\text{C}$, $V_{IN} = V_{OUT(NOM)} + 1.0\text{ V}$ or 2.5 V (whichever is greater), $I_{OUT} = 1\text{ mA}$, $C_{IN} = 1\text{ }\mu\text{F}$, and $C_{OUT} = 1\text{ }\mu\text{F}$ (unless otherwise noted)

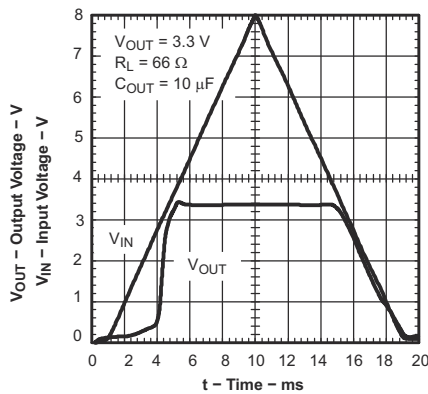

Figure 8-4. Power-Up and Power-Down for Legacy Chip

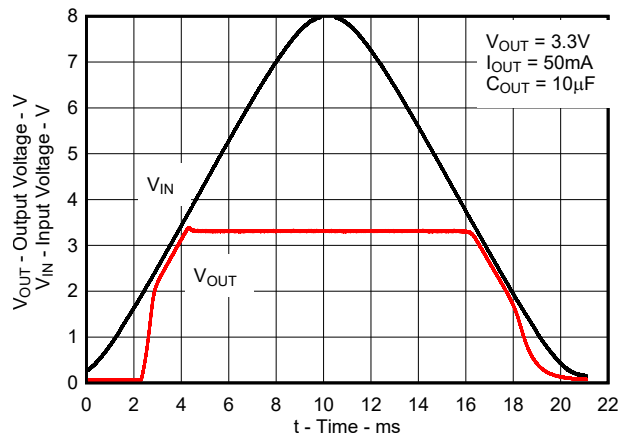

Figure 8-5. Power-Up and Power-Down for New Chip

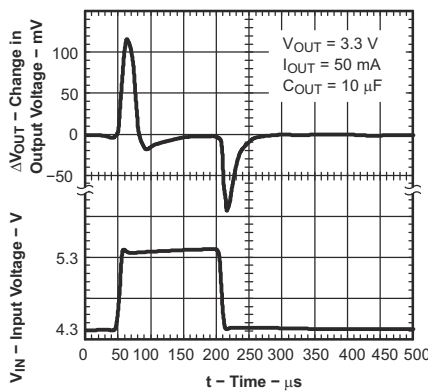

Figure 8-6. Line Transient Response for Legacy Chip

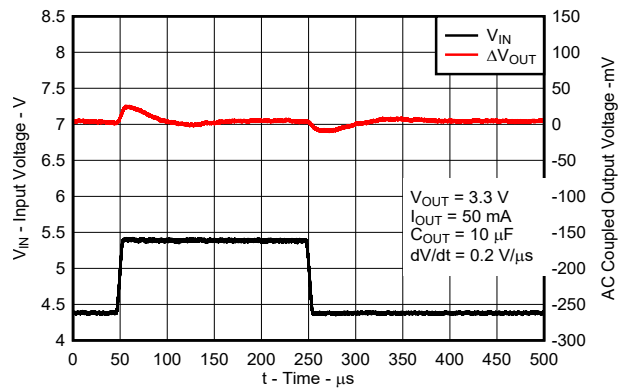

Figure 8-7. Line Transient Response for New Chip

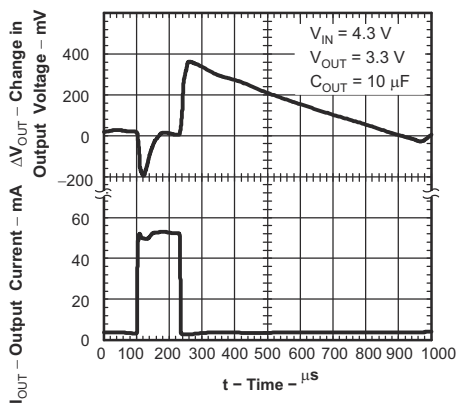

Figure 8-8. Load Transient Response for Legacy Chip

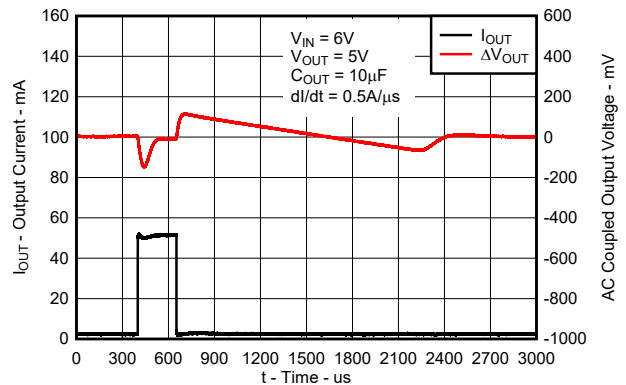

Figure 8-9. Load Transient Response for New Chip

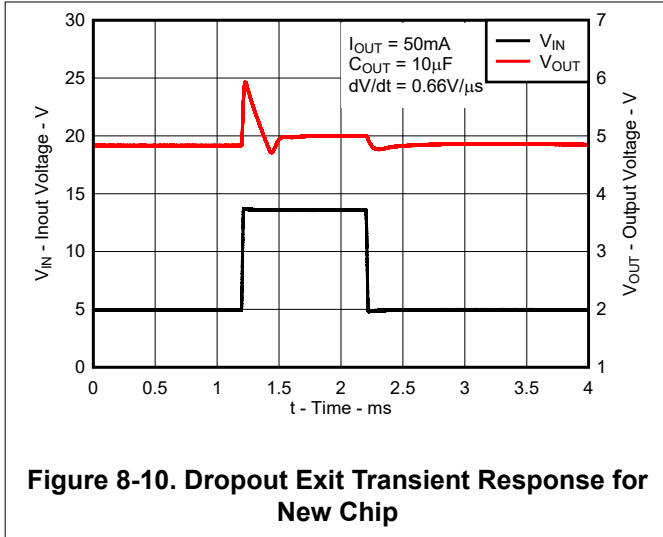

Figure 8-10. Dropout Exit Transient Response for New Chip

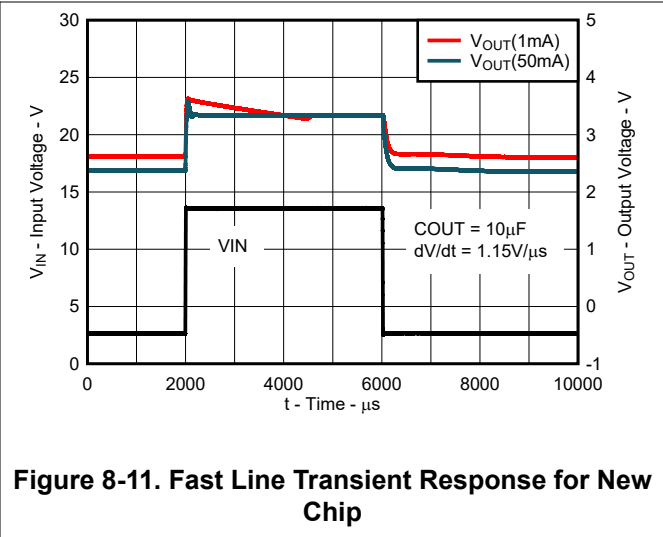

Figure 8-11. Fast Line Transient Response for New Chip

8.3 Best Design Practices

Place at least one 0.47- μ F capacitor as close as possible to the OUT and GND terminals of the regulator.

Do not connect the output capacitor to the regulator using a long, thin trace.

Connect an input capacitor as close as possible to the IN and GND terminals of the regulator for best performance.

Do not exceed the absolute maximum ratings.

8.4 Power Supply Recommendations

The TPS715 is designed to operate from an input voltage supply range between 2.5 V and 24 V. The input voltage range provides adequate headroom in order for the device to have a regulated output. If the input supply is noisy, additional input capacitors with low ESR can help improve the output noise performance.

8.5 Layout

8.5.1 Layout Guidelines

For best overall performance, place all circuit components on the same side of the printed-circuit-board and as near as practical to the respective LDO pin connections. Place ground return connections for the input and output capacitors as close to the GND pin as possible, using wide, component-side, copper planes. Do not use vias and long traces to create LDO circuit connections to the input capacitor, output capacitor, or the resistor divider because this practice negatively affects system performance. This grounding and layout scheme minimizes inductive parasitics, and thereby reduces load-current transients, minimizes noise, and increases circuit stability. A ground reference plane is also recommended and is either embedded in the PCB itself or located on the bottom side of the PCB opposite the components. This reference plane serves to assure accuracy of the output voltage and shield the LDO from noise.

8.5.1.1 Power Dissipation

To ensure reliable operation, worst-case junction temperature must not exceed 125°C. This restriction limits the power dissipation the regulator can handle in any given application. To ensure the junction temperature is within acceptable limits, calculate the maximum allowable dissipation, $P_{D(max)}$, and the actual dissipation, P_D , which must be less than or equal to $P_{D(max)}$.

The maximum-power-dissipation limit is determined using [Equation 11](#):

$$P_{D(max)} = \frac{T_{Jmax} - T_A}{R_{\theta JA}} \quad (11)$$

where

- T_{Jmax} is the maximum allowable junction temperature
- $R_{\theta JA}$ is the thermal resistance junction-to-ambient for the package (see the [Thermal Information](#) table)
- T_A is the ambient temperature

The regulator dissipation is calculated using [Equation 12](#):

$$P_D = (V_{IN} - V_{OUT}) \times I_{OUT} \quad (12)$$

For a higher power package version of the TPS715, see the [TPS715A](#).

8.5.2 Layout Example

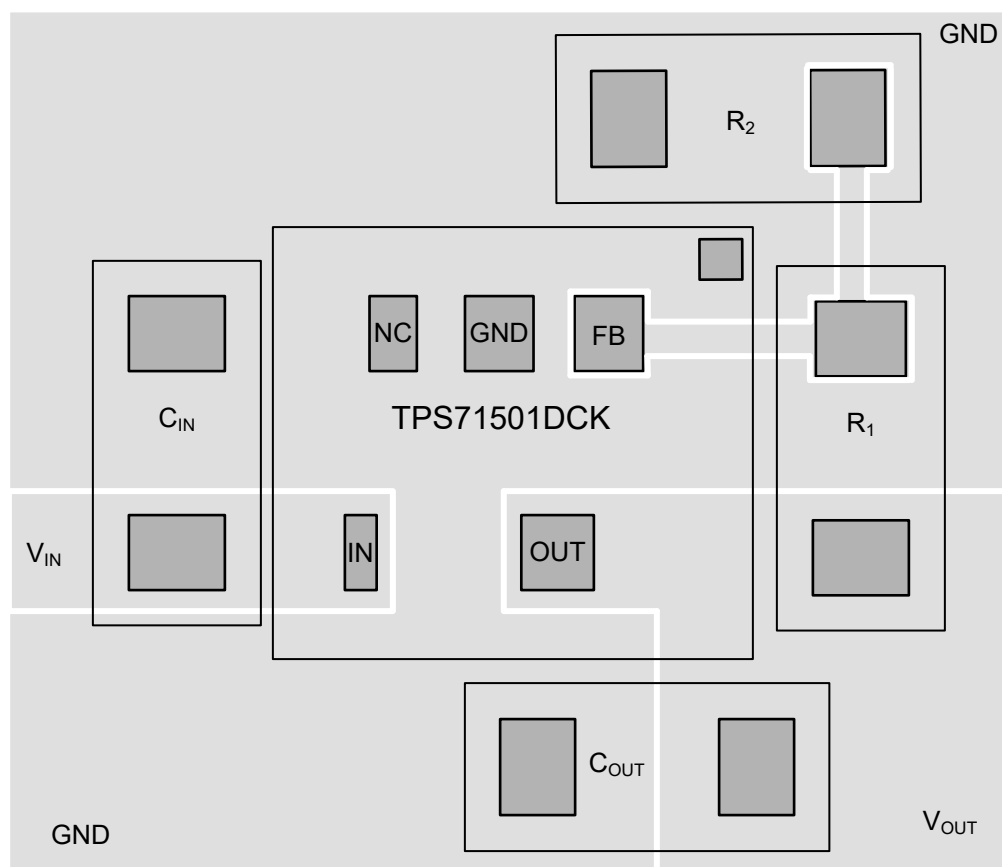

Figure 8-12. Example Layout for the TPS71501DCK

9 Device and Documentation Support

9.1 Device Support

9.1.1 Development Support

9.1.1.1 Evaluation Module

An evaluation module (EVM) is available to assist in the initial circuit performance evaluation using the TPS715. The [TPS71533EVM evaluation module](#) (and related [user's guide](#)) can be requested at the TI website through the product folders or purchased directly from [the TI eStore](#).

9.1.1.2 Spice Models

Computer simulation of circuit performance using SPICE is often useful when analyzing the performance of analog circuits and systems. A SPICE model for the TPS715 is available through the product folders under *Tools & Software*.

9.1.2 Device Nomenclature

Table 9-1. Device Nomenclature⁽¹⁾

| PRODUCT | V _{OUT} |
|-----------------------------|---|
| TPS715xxyyyz Legacy chip | xx is the nominal output voltage (for example, 28 = 2.8 V, 285 = 2.85 V, 01 = Adjustable). yyy is the package designator. z is the package quantity. |
| TPS715xxyyyz M3 New chip | xx is the nominal output voltage (for example, 28 = 2.8 V, 285 = 2.85 V, 01 = Adjustable). yyy is the package designator. z is the package quantity. M3 is a suffix designator for new chip redesigns on the latest TI process technology. |

(1) For the most current package and ordering information see the Package Option Addendum at the end of this document, or see the TI website at [www.ti.com](#).

9.2 Documentation Support

9.2.1 Related Documentation

For related documentation see the following:

- Texas Instruments, [TPS715A 24-V High Input Voltage, Micropower, 80-mA LDO Voltage Regulator data sheet](#)
- Texas Instruments, [TPS71533EVM LDO Evaluation Module user guide](#)
- Texas Instruments, [Pros and Cons of Using a Feedforward Capacitor with a Low-Dropout Regulator application note](#)
- Texas Instruments, [Know Your Limits application note](#)

9.3 Receiving Notification of Documentation Updates

To receive notification of documentation updates, navigate to the device product folder on [ti.com](#). Click on *Subscribe to updates* to register and receive a weekly digest of any product information that has changed. For change details, review the revision history included in any revised document.

9.4 Support Resources

[TI E2E™ support forums](#) are an engineer's go-to source for fast, verified answers and design help — straight from the experts. Search existing answers or ask your own question to get the quick design help you need.

Linked content is provided "AS IS" by the respective contributors. They do not constitute TI specifications and do not necessarily reflect TI's views; see TI's [Terms of Use](#).

9.5 Trademarks

TI E2E™ is a trademark of Texas Instruments.

All trademarks are the property of their respective owners.

9.6 Electrostatic Discharge Caution



This integrated circuit can be damaged by ESD. Texas Instruments recommends that all integrated circuits be handled with appropriate precautions. Failure to observe proper handling and installation procedures can cause damage.

ESD damage can range from subtle performance degradation to complete device failure. Precision integrated circuits may be more susceptible to damage because very small parametric changes could cause the device not to meet its published specifications.

9.7 Glossary

[TI Glossary](#) This glossary lists and explains terms, acronyms, and definitions.

10 Mechanical, Packaging, and Orderable Information

The following pages include mechanical, packaging, and orderable information. This information is the most current data available for the designated devices. This data is subject to change without notice and revision of this document. For browser-based versions of this data sheet, refer to the left-hand navigation.

PACKAGING INFORMATION

| Orderable Device | Status (1) | Package Type | Package Drawing | Pins | Package Qty | Eco Plan (2) | Lead finish/ Ball material (6) | MSL Peak Temp (3) | Op Temp (°C) | Device Marking (4/5) | Samples |
|------------------|---------------|--------------|-----------------|------|-------------|-----------------|--------------------------------------|----------------------|--------------|-------------------------|-------------------------|
| TPS71501DCKR | ACTIVE | SC70 | DCK | 5 | 3000 | RoHS & Green | NIPDAU NIPDAUAG | Level-1-260C-UNLIM | -40 to 125 | ARB | Samples |
| TPS71501DCKRG4 | ACTIVE | SC70 | DCK | 5 | 3000 | RoHS & Green | NIPDAU | Level-1-260C-UNLIM | -40 to 125 | ARB | Samples |
| TPS71501DCKRM3 | ACTIVE | SC70 | DCK | 5 | 3000 | RoHS & Green | NIPDAU | Level-1-260C-UNLIM | -40 to 125 | ARB | Samples |
| TPS71518DCKR | ACTIVE | SC70 | DCK | 5 | 3000 | RoHS & Green | NIPDAUAG | Level-1-260C-UNLIM | -40 to 125 | ARD | Samples |
| TPS71518DCKRG4 | ACTIVE | SC70 | DCK | 5 | 3000 | RoHS & Green | NIPDAUAG | Level-1-260C-UNLIM | -40 to 125 | ARD | Samples |
| TPS71518DCKRM3 | ACTIVE | SC70 | DCK | 5 | 3000 | RoHS & Green | NIPDAU | Level-1-260C-UNLIM | -40 to 125 | ARD | Samples |
| TPS71519DCKR | ACTIVE | SC70 | DCK | 5 | 3000 | RoHS & Green | NIPDAUAG | Level-1-260C-UNLIM | -40 to 125 | BOX | Samples |
| TPS71523DCKR | ACTIVE | SC70 | DCK | 5 | 3000 | RoHS & Green | NIPDAU NIPDAUAG | Level-1-260C-UNLIM | -40 to 125 | BNX | Samples |
| TPS71523DCKRM3 | ACTIVE | SC70 | DCK | 5 | 3000 | RoHS & Green | NIPDAU | Level-1-260C-UNLIM | -40 to 125 | BNX | Samples |
| TPS71525DCKR | ACTIVE | SC70 | DCK | 5 | 3000 | RoHS & Green | NIPDAU | Level-1-260C-UNLIM | -40 to 125 | AQL | Samples |
| TPS71525DCKRG4 | ACTIVE | SC70 | DCK | 5 | 3000 | RoHS & Green | NIPDAU | Level-1-260C-UNLIM | -40 to 125 | AQL | Samples |
| TPS71525DCKRM3 | ACTIVE | SC70 | DCK | 5 | 3000 | RoHS & Green | NIPDAU | Level-1-260C-UNLIM | -40 to 125 | AQL | Samples |
| TPS71530DCKR | ACTIVE | SC70 | DCK | 5 | 3000 | RoHS & Green | NIPDAU NIPDAUAG | Level-1-260C-UNLIM | -40 to 125 | AQM | Samples |
| TPS71530DCKRG4 | ACTIVE | SC70 | DCK | 5 | 3000 | RoHS & Green | NIPDAU | Level-1-260C-UNLIM | -40 to 125 | AQM | Samples |
| TPS71530DCKRM3 | ACTIVE | SC70 | DCK | 5 | 3000 | RoHS & Green | NIPDAU | Level-1-260C-UNLIM | -40 to 125 | AQM | Samples |
| TPS71533DCKR | ACTIVE | SC70 | DCK | 5 | 3000 | RoHS & Green | NIPDAU NIPDAUAG | Level-1-260C-UNLIM | -40 to 125 | AQI | Samples |
| TPS71533DCKRG4 | ACTIVE | SC70 | DCK | 5 | 3000 | RoHS & Green | NIPDAU | Level-1-260C-UNLIM | -40 to 125 | AQI | Samples |
| TPS71533DCKRM3 | ACTIVE | SC70 | DCK | 5 | 3000 | RoHS & Green | NIPDAU | Level-1-260C-UNLIM | -40 to 125 | AQI | Samples |
| TPS715345DCKR | ACTIVE | SC70 | DCK | 5 | 3000 | RoHS & Green | NIPDAU NIPDAUAG | Level-1-260C-UNLIM | -40 to 125 | BNY | Samples |
| TPS715345DCKRM3 | ACTIVE | SC70 | DCK | 5 | 3000 | RoHS & Green | NIPDAU | Level-1-260C-UNLIM | -40 to 125 | BNY | Samples |

| Orderable Device | Status (1) | Package Type | Package Drawing | Pins | Package Qty | Eco Plan (2) | Lead finish/ Ball material (6) | MSL Peak Temp (3) | Op Temp (°C) | Device Marking (4/5) | Samples |
|------------------|---------------|--------------|-----------------|------|-------------|-----------------|--------------------------------------|----------------------|--------------|-------------------------|-------------------------|
| TPS71550DCKR | ACTIVE | SC70 | DCK | 5 | 3000 | RoHS & Green | NIPDAU NIPDAUAG | Level-1-260C-UNLIM | -40 to 125 | T48 | Samples |
| TPS71550DCKRG4 | ACTIVE | SC70 | DCK | 5 | 3000 | RoHS & Green | NIPDAU | Level-1-260C-UNLIM | -40 to 125 | T48 | Samples |
| TPS71550DCKRM3 | ACTIVE | SC70 | DCK | 5 | 3000 | RoHS & Green | NIPDAU | Level-1-260C-UNLIM | -40 to 125 | T48 | Samples |

(1) The marketing status values are defined as follows:

ACTIVE: Product device recommended for new designs.

LIFEBUY: TI has announced that the device will be discontinued, and a lifetime-buy period is in effect.

NRND: Not recommended for new designs. Device is in production to support existing customers, but TI does not recommend using this part in a new design.

PREVIEW: Device has been announced but is not in production. Samples may or may not be available.

OBSELETE: TI has discontinued the production of the device.

(2) **RoHS:** TI defines "RoHS" to mean semiconductor products that are compliant with the current EU RoHS requirements for all 10 RoHS substances, including the requirement that RoHS substance do not exceed 0.1% by weight in homogeneous materials. Where designed to be soldered at high temperatures, "RoHS" products are suitable for use in specified lead-free processes. TI may reference these types of products as "Pb-Free".

RoHS Exempt: TI defines "RoHS Exempt" to mean products that contain lead but are compliant with EU RoHS pursuant to a specific EU RoHS exemption.

Green: TI defines "Green" to mean the content of Chlorine (Cl) and Bromine (Br) based flame retardants meet JS709B low halogen requirements of <=1000ppm threshold. Antimony trioxide based flame retardants must also meet the <=1000ppm threshold requirement.

(3) MSL, Peak Temp. - The Moisture Sensitivity Level rating according to the JEDEC industry standard classifications, and peak solder temperature.

(4) There may be additional marking, which relates to the logo, the lot trace code information, or the environmental category on the device.

(5) Multiple Device Markings will be inside parentheses. Only one Device Marking contained in parentheses and separated by a "-" will appear on a device. If a line is indented then it is a continuation of the previous line and the two combined represent the entire Device Marking for that device.

(6) Lead finish/Ball material - Orderable Devices may have multiple material finish options. Finish options are separated by a vertical ruled line. Lead finish/Ball material values may wrap to two lines if the finish value exceeds the maximum column width.

Important Information and Disclaimer:The information provided on this page represents TI's knowledge and belief as of the date that it is provided. TI bases its knowledge and belief on information provided by third parties, and makes no representation or warranty as to the accuracy of such information. Efforts are underway to better integrate information from third parties. TI has taken and continues to take reasonable steps to provide representative and accurate information but may not have conducted destructive testing or chemical analysis on incoming materials and chemicals. TI and TI suppliers consider certain information to be proprietary, and thus CAS numbers and other limited information may not be available for release.

In no event shall TI's liability arising out of such information exceed the total purchase price of the TI part(s) at issue in this document sold by TI to Customer on an annual basis.

OTHER QUALIFIED VERSIONS OF TPS715 :

- Automotive : [TPS715-Q1](#)

NOTE: Qualified Version Definitions:

- Automotive - Q100 devices qualified for high-reliability automotive applications targeting zero defects

TAPE AND REEL INFORMATION

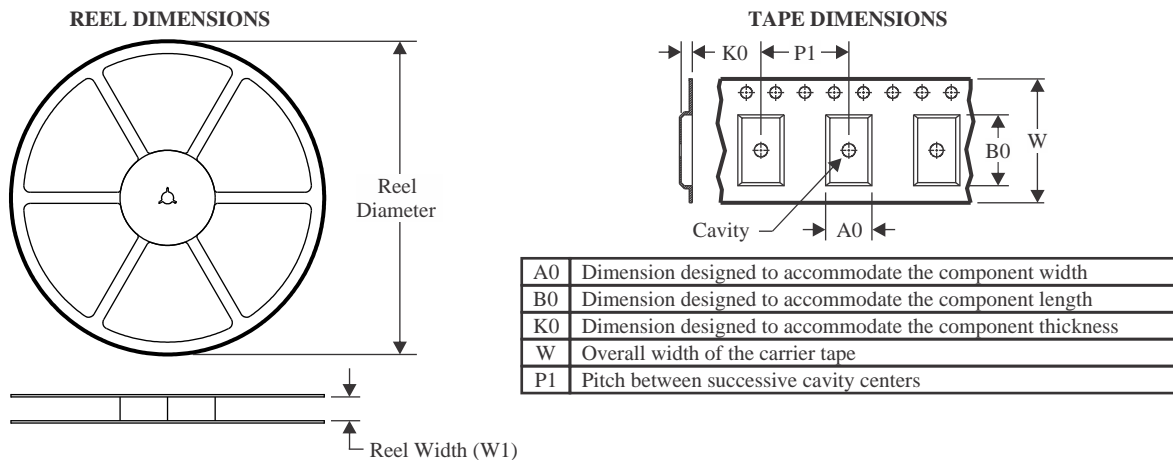

QUADRANT ASSIGNMENTS FOR PIN 1 ORIENTATION IN TAPE

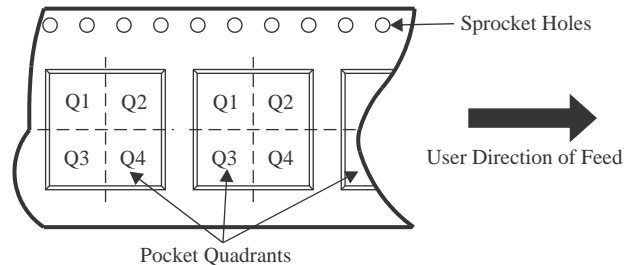

*All dimensions are nominal

| Device | Package Type | Package Drawing | Pins | SPQ | Reel Diameter (mm) | Reel Width W1 (mm) | A0 (mm) | B0 (mm) | K0 (mm) | P1 (mm) | W (mm) | Pin1 Quadrant |
|----------------|--------------|-----------------|------|------|--------------------|--------------------|---------|---------|---------|---------|--------|---------------|
| TPS71501DCKR | SC70 | DCK | 5 | 3000 | 178.0 | 9.0 | 2.4 | 2.5 | 1.2 | 4.0 | 8.0 | Q3 |
| TPS71501DCKR | SC70 | DCK | 5 | 3000 | 178.0 | 9.0 | 2.4 | 2.5 | 1.2 | 4.0 | 8.0 | Q3 |
| TPS71501DCKRM3 | SC70 | DCK | 5 | 3000 | 178.0 | 9.0 | 2.4 | 2.5 | 1.2 | 4.0 | 8.0 | Q3 |
| TPS71518DCKR | SC70 | DCK | 5 | 3000 | 180.0 | 8.4 | 2.41 | 2.41 | 1.2 | 4.0 | 8.0 | Q3 |
| TPS71518DCKRM3 | SC70 | DCK | 5 | 3000 | 178.0 | 9.0 | 2.4 | 2.5 | 1.2 | 4.0 | 8.0 | Q3 |
| TPS71519DCKR | SC70 | DCK | 5 | 3000 | 180.0 | 8.4 | 2.41 | 2.41 | 1.2 | 4.0 | 8.0 | Q3 |
| TPS71523DCKR | SC70 | DCK | 5 | 3000 | 178.0 | 9.0 | 2.4 | 2.5 | 1.2 | 4.0 | 8.0 | Q3 |
| TPS71523DCKR | SC70 | DCK | 5 | 3000 | 178.0 | 9.0 | 2.4 | 2.5 | 1.2 | 4.0 | 8.0 | Q3 |
| TPS71523DCKR | SC70 | DCK | 5 | 3000 | 180.0 | 8.4 | 2.41 | 2.41 | 1.2 | 4.0 | 8.0 | Q3 |
| TPS71523DCKRM3 | SC70 | DCK | 5 | 3000 | 178.0 | 9.0 | 2.4 | 2.5 | 1.2 | 4.0 | 8.0 | Q3 |
| TPS71525DCKR | SC70 | DCK | 5 | 3000 | 178.0 | 9.0 | 2.4 | 2.5 | 1.2 | 4.0 | 8.0 | Q3 |
| TPS71525DCKRM3 | SC70 | DCK | 5 | 3000 | 178.0 | 9.0 | 2.4 | 2.5 | 1.2 | 4.0 | 8.0 | Q3 |
| TPS71530DCKR | SC70 | DCK | 5 | 3000 | 178.0 | 9.0 | 2.4 | 2.5 | 1.2 | 4.0 | 8.0 | Q3 |
| TPS71530DCKR | SC70 | DCK | 5 | 3000 | 180.0 | 8.4 | 2.41 | 2.41 | 1.2 | 4.0 | 8.0 | Q3 |
| TPS71530DCKR | SC70 | DCK | 5 | 3000 | 178.0 | 9.0 | 2.4 | 2.5 | 1.2 | 4.0 | 8.0 | Q3 |
| TPS71530DCKRM3 | SC70 | DCK | 5 | 3000 | 178.0 | 9.0 | 2.4 | 2.5 | 1.2 | 4.0 | 8.0 | Q3 |

| Device | Package Type | Package Drawing | Pins | SPQ | Reel Diameter (mm) | Reel Width W1 (mm) | A0 (mm) | B0 (mm) | K0 (mm) | P1 (mm) | W (mm) | Pin1 Quadrant |
|-----------------|--------------|-----------------|------|------|--------------------|--------------------|---------|---------|---------|---------|--------|---------------|
| TPS71533DCKR | SC70 | DCK | 5 | 3000 | 180.0 | 8.4 | 2.41 | 2.41 | 1.2 | 4.0 | 8.0 | Q3 |
| TPS71533DCKR | SC70 | DCK | 5 | 3000 | 178.0 | 9.0 | 2.4 | 2.5 | 1.2 | 4.0 | 8.0 | Q3 |
| TPS71533DCKR | SC70 | DCK | 5 | 3000 | 178.0 | 9.0 | 2.4 | 2.5 | 1.2 | 4.0 | 8.0 | Q3 |
| TPS71533DCKRM3 | SC70 | DCK | 5 | 3000 | 178.0 | 9.0 | 2.4 | 2.5 | 1.2 | 4.0 | 8.0 | Q3 |
| TPS715345DCKR | SC70 | DCK | 5 | 3000 | 178.0 | 9.0 | 2.4 | 2.5 | 1.2 | 4.0 | 8.0 | Q3 |
| TPS715345DCKR | SC70 | DCK | 5 | 3000 | 180.0 | 8.4 | 2.41 | 2.41 | 1.2 | 4.0 | 8.0 | Q3 |
| TPS715345DCKRM3 | SC70 | DCK | 5 | 3000 | 178.0 | 9.0 | 2.4 | 2.5 | 1.2 | 4.0 | 8.0 | Q3 |
| TPS71550DCKR | SC70 | DCK | 5 | 3000 | 178.0 | 9.0 | 2.4 | 2.5 | 1.2 | 4.0 | 8.0 | Q3 |
| TPS71550DCKR | SC70 | DCK | 5 | 3000 | 180.0 | 8.4 | 2.41 | 2.41 | 1.2 | 4.0 | 8.0 | Q3 |
| TPS71550DCKR | SC70 | DCK | 5 | 3000 | 178.0 | 9.0 | 2.4 | 2.5 | 1.2 | 4.0 | 8.0 | Q3 |
| TPS71550DCKRM3 | SC70 | DCK | 5 | 3000 | 178.0 | 9.0 | 2.4 | 2.5 | 1.2 | 4.0 | 8.0 | Q3 |

TAPE AND REEL BOX DIMENSIONS

*All dimensions are nominal

| Device | Package Type | Package Drawing | Pins | SPQ | Length (mm) | Width (mm) | Height (mm) |
|----------------|--------------|-----------------|------|------|-------------|------------|-------------|
| TPS71501DCKR | SC70 | DCK | 5 | 3000 | 180.0 | 180.0 | 18.0 |
| TPS71501DCKR | SC70 | DCK | 5 | 3000 | 180.0 | 180.0 | 18.0 |
| TPS71501DCKRM3 | SC70 | DCK | 5 | 3000 | 180.0 | 180.0 | 18.0 |
| TPS71518DCKR | SC70 | DCK | 5 | 3000 | 183.0 | 183.0 | 20.0 |
| TPS71518DCKRM3 | SC70 | DCK | 5 | 3000 | 180.0 | 180.0 | 18.0 |
| TPS71519DCKR | SC70 | DCK | 5 | 3000 | 183.0 | 183.0 | 20.0 |
| TPS71523DCKR | SC70 | DCK | 5 | 3000 | 180.0 | 180.0 | 18.0 |
| TPS71523DCKR | SC70 | DCK | 5 | 3000 | 180.0 | 180.0 | 18.0 |
| TPS71523DCKR | SC70 | DCK | 5 | 3000 | 183.0 | 183.0 | 20.0 |
| TPS71523DCKRM3 | SC70 | DCK | 5 | 3000 | 180.0 | 180.0 | 18.0 |
| TPS71525DCKR | SC70 | DCK | 5 | 3000 | 180.0 | 180.0 | 18.0 |
| TPS71525DCKRM3 | SC70 | DCK | 5 | 3000 | 180.0 | 180.0 | 18.0 |
| TPS71530DCKR | SC70 | DCK | 5 | 3000 | 180.0 | 180.0 | 18.0 |
| TPS71530DCKR | SC70 | DCK | 5 | 3000 | 183.0 | 183.0 | 20.0 |
| TPS71530DCKR | SC70 | DCK | 5 | 3000 | 180.0 | 180.0 | 18.0 |
| TPS71530DCKRM3 | SC70 | DCK | 5 | 3000 | 180.0 | 180.0 | 18.0 |
| TPS71533DCKR | SC70 | DCK | 5 | 3000 | 183.0 | 183.0 | 20.0 |
| TPS71533DCKR | SC70 | DCK | 5 | 3000 | 180.0 | 180.0 | 18.0 |

| Device | Package Type | Package Drawing | Pins | SPQ | Length (mm) | Width (mm) | Height (mm) |
|-----------------|--------------|-----------------|------|------|-------------|------------|-------------|
| TPS71533DCKR | SC70 | DCK | 5 | 3000 | 180.0 | 180.0 | 18.0 |
| TPS71533DCKRM3 | SC70 | DCK | 5 | 3000 | 180.0 | 180.0 | 18.0 |
| TPS715345DCKR | SC70 | DCK | 5 | 3000 | 180.0 | 180.0 | 18.0 |
| TPS715345DCKR | SC70 | DCK | 5 | 3000 | 183.0 | 183.0 | 20.0 |
| TPS715345DCKRM3 | SC70 | DCK | 5 | 3000 | 180.0 | 180.0 | 18.0 |
| TPS71550DCKR | SC70 | DCK | 5 | 3000 | 180.0 | 180.0 | 18.0 |
| TPS71550DCKR | SC70 | DCK | 5 | 3000 | 183.0 | 183.0 | 20.0 |
| TPS71550DCKR | SC70 | DCK | 5 | 3000 | 180.0 | 180.0 | 18.0 |
| TPS71550DCKRM3 | SC70 | DCK | 5 | 3000 | 180.0 | 180.0 | 18.0 |

DCK0005A



PACKAGE OUTLINE

SOT - 1.1 max height

SMALL OUTLINE TRANSISTOR

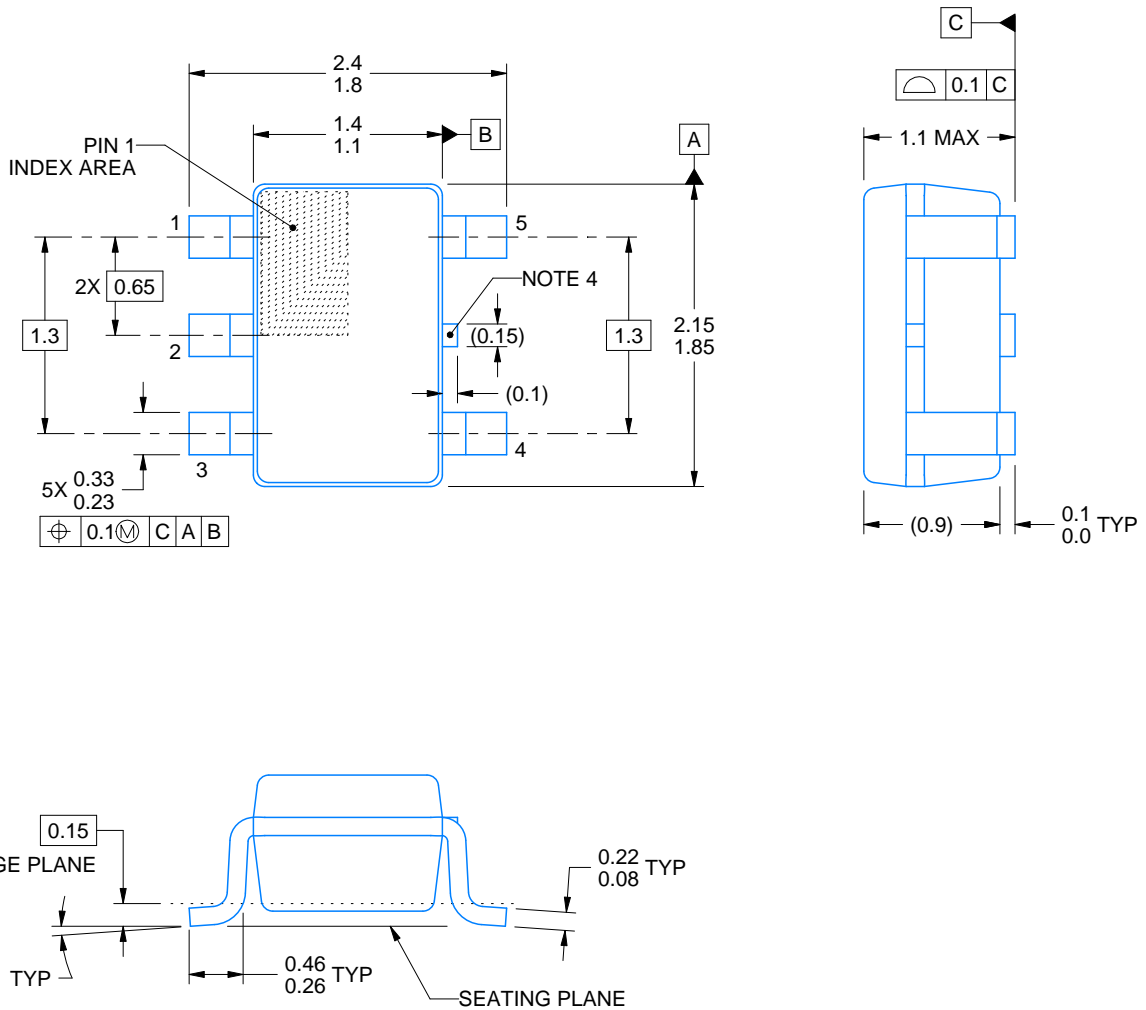

4214834/C 03/2023

NOTES:

1. All linear dimensions are in millimeters. Any dimensions in parenthesis are for reference only. Dimensioning and tolerancing per ASME Y14.5M.
2. This drawing is subject to change without notice.
3. Reference JEDEC MO-203.
4. Support pin may differ or may not be present.

EXAMPLE BOARD LAYOUT

DCK0005A

SOT - 1.1 max height

SMALL OUTLINE TRANSISTOR

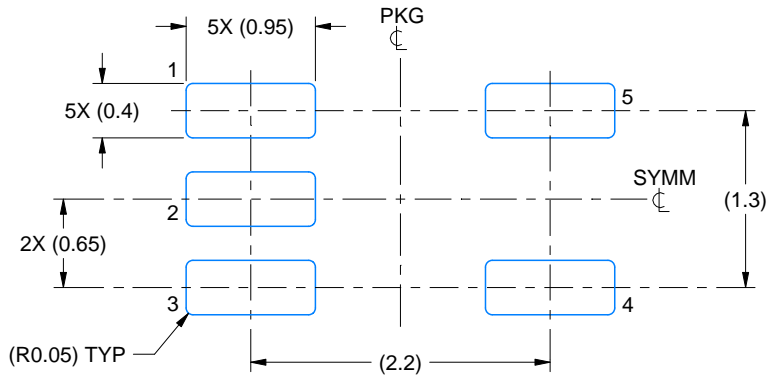

LAND PATTERN EXAMPLE
EXPOSED METAL SHOWN
SCALE:18X

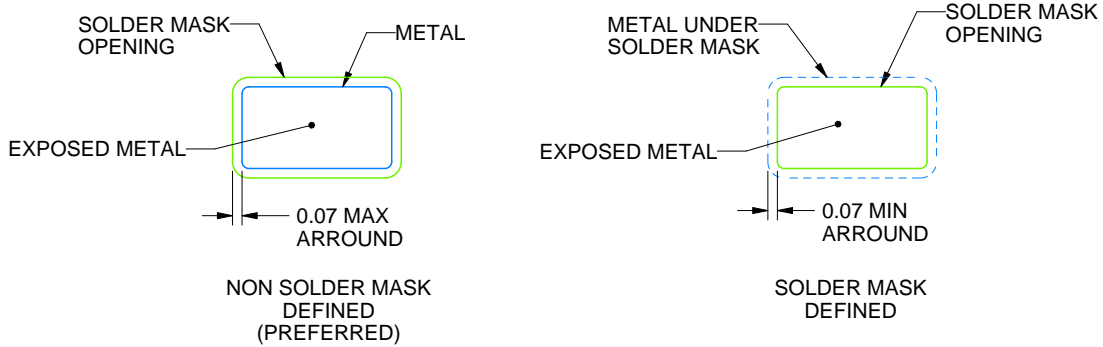

SOLDER MASK DETAILS

4214834/C 03/2023

NOTES: (continued)

- 4. Publication IPC-7351 may have alternate designs.
- 5. Solder mask tolerances between and around signal pads can vary based on board fabrication site.

EXAMPLE STENCIL DESIGN

DCK0005A

SOT - 1.1 max height

SMALL OUTLINE TRANSISTOR

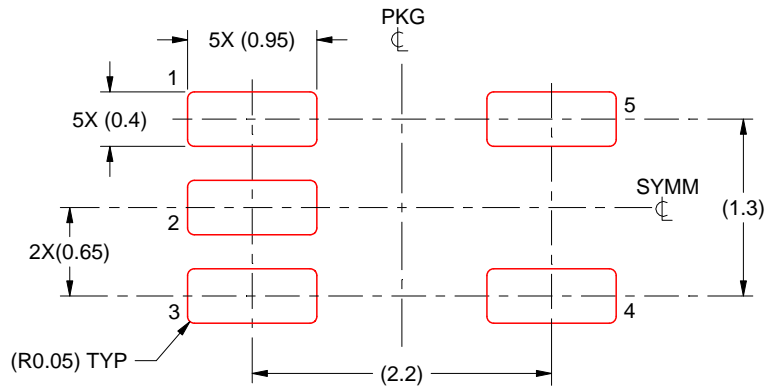

SOLDER PASTE EXAMPLE
BASED ON 0.125 THICK STENCIL
SCALE:18X

4214834/C 03/2023

NOTES: (continued)

6. Laser cutting apertures with trapezoidal walls and rounded corners may offer better paste release. IPC-7525 may have alternate design recommendations.
7. Board assembly site may have different recommendations for stencil design.

IMPORTANT NOTICE AND DISCLAIMER

TI PROVIDES TECHNICAL AND RELIABILITY DATA (INCLUDING DATA SHEETS), DESIGN RESOURCES (INCLUDING REFERENCE DESIGNS), APPLICATION OR OTHER DESIGN ADVICE, WEB TOOLS, SAFETY INFORMATION, AND OTHER RESOURCES "AS IS" AND WITH ALL FAULTS, AND DISCLAIMS ALL WARRANTIES, EXPRESS AND IMPLIED, INCLUDING WITHOUT LIMITATION ANY IMPLIED WARRANTIES OF MERCHANTABILITY, FITNESS FOR A PARTICULAR PURPOSE OR NON-INFRINGEMENT OF THIRD PARTY INTELLECTUAL PROPERTY RIGHTS.

These resources are intended for skilled developers designing with TI products. You are solely responsible for (1) selecting the appropriate TI products for your application, (2) designing, validating and testing your application, and (3) ensuring your application meets applicable standards, and any other safety, security, regulatory or other requirements.

These resources are subject to change without notice. TI grants you permission to use these resources only for development of an application that uses the TI products described in the resource. Other reproduction and display of these resources is prohibited. No license is granted to any other TI intellectual property right or to any third party intellectual property right. TI disclaims responsibility for, and you will fully indemnify TI and its representatives against, any claims, damages, costs, losses, and liabilities arising out of your use of these resources.

TI's products are provided subject to [TI's Terms of Sale](#) or other applicable terms available either on [ti.com](https://www.ti.com) or provided in conjunction with such TI products. TI's provision of these resources does not expand or otherwise alter TI's applicable warranties or warranty disclaimers for TI products.

TI objects to and rejects any additional or different terms you may have proposed.

Mailing Address: Texas Instruments, Post Office Box 655303, Dallas, Texas 75265
Copyright © 2023, Texas Instruments Incorporated