

Solid Tantalum Surface Mount Chip Capacitors, Molded Case, Extended Range



PERFORMANCE / ELECTRICAL CHARACTERISTICS

Operating Temperature: -55 °C to +125 °C
(above 85 °C, voltage derating is required)

Capacitance Range: 0.47 μF to 470 μF

Capacitance Tolerance: ± 10 %, ± 20 %

Voltage Rating: 2.5 V_{DC} to 35 V_{DC}

FEATURES

- Small size, suitable for high density packaging
- Terminations: 100 % matte tin
- Qualified to EIA-717
- MSL level: 1
- Compatible with “high volume” automatic pick and place equipment
- Material categorization:
for definitions of compliance please see www.vishay.com/doc?99912



RoHS COMPLIANT
HALOGEN FREE Available
GREEN
(5-2008) Available

APPLICATIONS

- Industrial
- AV equipment
- General purpose

ORDERING INFORMATION

TMCM TYPE	A CASE CODE	OJ DC VOLTAGE RATING AT +85 °C	106 CAPACITANCE (μF)	M CAPACITANCE TOLERANCE	TR PACKAGING POLARITY	(2) (OPTIONAL)	F TERMINAL CODE
	See Ratings and Case Codes table	0E = 2.5 V 0G = 4.0 V 0J = 6.3 V (7 V) 1A = 10 V 1C = 16 V 1D = 20 V 1E = 25 V 1V = 35 V	This is expressed in picofarads. The first two digits are the significant figures. The third is the number of zeros to follow.	K = ± 10 % M = ± 20 %	TR = 7" reel, cathodes close to perforation side	Halogen-free (special order), not applicable for E case	F = lead (Pb)-free terminations

DIMENSIONS in inches [millimeters]

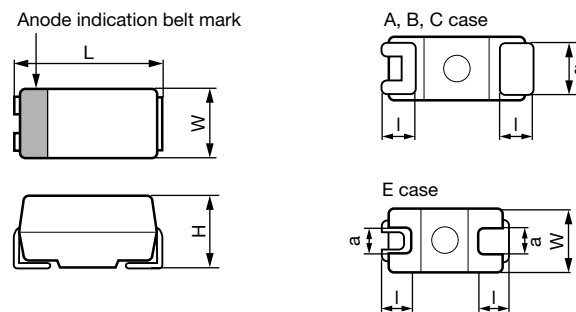

CASE CODE	EIA SIZE	L	W	H	l	a
A	3216-18	0.126 ± 0.008 [3.2 ± 0.2]	0.063 ± 0.008 [1.6 ± 0.2]	0.063 ± 0.008 [1.6 ± 0.2]	0.028 ± 0.012 [0.7 ± 0.3]	0.047 ± 0.008 [1.2 ± 0.2]
B	3528-21	0.138 ± 0.008 [3.5 ± 0.2]	0.110 ± 0.008 [2.8 ± 0.2]	0.075 ± 0.008 [1.9 ± 0.2]	0.030 ± 0.012 [0.8 ± 0.3]	0.087 ± 0.008 [2.2 ± 0.2]
C	6032-28	0.228 ± 0.008 [5.8 ± 0.2]	0.126 ± 0.008 [3.2 ± 0.2]	0.100 ± 0.008 [2.5 ± 0.2]	0.051 ± 0.012 [1.3 ± 0.3]	0.087 ± 0.008 [2.2 ± 0.2]
E	7343-30	0.287 ± 0.008 [7.3 ± 0.2]	0.169 ± 0.012 [4.3 ± 0.3]	0.112 ± 0.008 [2.8 ± 0.2]	0.051 ± 0.012 [1.3 ± 0.3]	0.094 ± 0.008 [2.4 ± 0.2]

RATINGS AND CASE CODES								
μF	2.5 V	4.0 V	6.3 V (7 V)	10 V	16 V	20 V	25 V	35 V
0.47								A
0.68							A	A
1.0						A	A	A
1.5					A	A	A	A/B
2.2				A	A	A	A/B	A/B
3.3			A	A	A	A/B	A/B	B
4.7		A	A	A	A/B	A/B	A/B	C
6.8	A	A	A	A/B	A/B	B	B/C	C
10	A	A	A/B	A/B	A/B	B/C	B/C	C/E
15	A	A/B	A/B	A/B	A/B/C	B/C	C/E	E
22	A/B	A/B	A/B	A/B/C	A/B/C	B/C/E	C/E	E
33	A/B	A/B	A/B/C	A/B/C	B/C/E	C/E	E	
47	A/B	A/B/C	A/B/C	A/B/C/E	B/C/E	E	E	
68	A/B/C	A/B/C	A/B/C/E	B/C/E	C/E	E		
100	A/B/C	A/B/C/E	A/B/C/E	B/C/E	C/E			
150	A/B/C/E	A/B/C/E	B/C/E	C/E				
220	A/B/C/E	A/B/C/E	B/C/E	E				
330	B/C/E	B/C/E	C/E	E				
470	B/C/E	E	E					

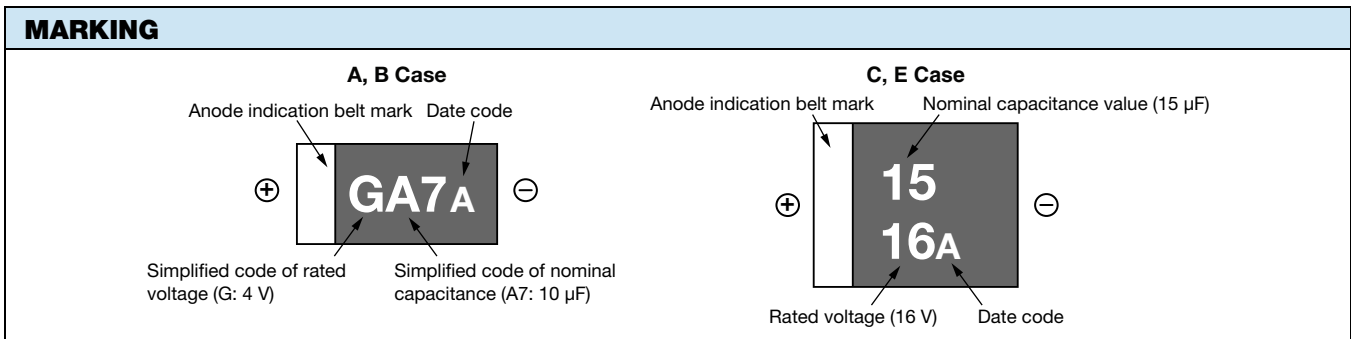

SIMPLIFIED VOLTAGE CODES, CASES A, B			
VOLTAGE CODE V	CODE	VOLTAGE CODE V	CODE
2.5	e	16	C
4.0	G	20	D
6.3 (7)	J	25	E
10	A	35	V

SIMPLIFIED CAP CODES, CASES A, B			
CAPACITANCE CODE μF	CODE	CAPACITANCE CODE μF	CODE
0.47	S5	22	J7
0.68	W5	33	N7
1.0	A6	47	S7
1.5	E6	68	W7
2.2	J6	100	A8
3.3	N6	150	E8
4.7	S6	220	J8
6.8	W6	330	N8
10	A7	470	S8
15	E7		



DATE CODE												
YEAR	MONTH											
	1	2	3	4	5	6	7	8	9	10	11	12
2017	A	B	C	D	E	F	G	H	J	K	L	M
2018	N	P	Q	R	S	T	U	V	W	X	Y	Z
2019	a	b	c	d	e	f	g	h	j	k	l	m
2020	n	p	q	r	s	t	u	v	w	x	y	z
2021	A	B	C	D	E	F	G	H	J	K	L	M
2022	N	P	Q	R	S	T	U	V	W	X	Y	Z
2023	a	b	c	d	e	f	g	h	j	k	l	m
2024	n	p	q	r	s	t	u	v	w	x	y	z

Note

- Marking code repeats every four years in alphabetical order (letter of l, i, O, and o are excluded)

STANDARD RATINGS						
CAPACITANCE (μ F)	CASE CODE	PART NUMBER	MAX. DCL AT +25 °C (μ A)	MAX. DF AT +25 °C, 120 Hz (%)	MAX. ESR AT +25 °C, 100 kHz (Ω)	MAX. RIPPLE, 100 kHz I _{RMS} (A)
2.5 V_{DC} AT +85 °C, 1.6 V_{DC} AT +125 °C						
6.8	A	TMCMA0E685(1)TRF	0.5	6	4.0	0.140
10	A	TMCMA0E106(1)TRF	0.5	8	2.0	0.197
15	A	TMCMA0E156(1)TRF	0.5	8	2.9	0.164
22	A	TMCMA0E226(1)TRF	0.6	8	2.0	0.197
22	B	TMCMB0E226(1)TRF	0.6	8	1.1	0.295
33	A	TMCMA0E336(1)TRF	0.8	8	2.0	0.197
33	B	TMCMB0E336(1)TRF	0.8	8	1.1	0.295
47	A	TMCMA0E476(1)TRF	1.2	12	2.0	0.197
47	B	TMCMB0E476(1)TRF	1.2	8	1.1	0.295
68	A	TMCMA0E686(1)TRF	1.7	18	2.0	0.197
68	B	TMCMB0E686(1)TRF	1.7	8	1.1	0.295
68	C	TMCMC0E686(1)TRF	1.7	8	1.1	0.302
100	A	TMCMA0E107(1)TRF	5.0	18	1.1	0.266
100	B	TMCMB0E107(1)TRF	2.5	12	1.1	0.295
100	C	TMCMC0E107(1)TRF	2.5	8	1.1	0.302
150	A	TMCMA0E157(1)TRF	7.5	30	1.8	0.208
150	B	TMCMB0E157(1)TRF	3.8	18	1.1	0.295
150	C	TMCMC0E157(1)TRF	3.8	8	1.1	0.302
150	E	TMCME0E157(1)TRF	3.8	8	0.3	0.632
220	A	TMCMA0E227(1)TRF	27.5	30	1.8	0.208
220	B	TMCMB0E227(1)TRF	5.5	18	1.1	0.295
220	C	TMCMC0E227(1)TRF	5.5	8	1.1	0.302
220	E	TMCME0E227(1)TRF	5.5	8	0.3	0.632
330	B	TMCMB0E337(1)TRF	16.5	30	1.1	0.295
330	C	TMCMC0E337(1)TRF	8.3	18	1.1	0.302
330	E	TMCME0E337(1)TRF	8.3	10	0.3	0.632
470	B	TMCMB0E477MTRF	58.8	30	1.1	0.295
470	C	TMCMC0E477(1)TRF	11.8	18	1.1	0.302
470	E	TMCME0E477(1)TRF	11.8	10	0.2	0.775

Note

- Part number definition:
(1) Tolerance: For 10 % tolerance, specify "K"; for 20 % tolerance, change to "M"



STANDARD RATINGS						
CAPACITANCE (μ F)	CASE CODE	PART NUMBER	MAX. DCL AT +25 °C (μ A)	MAX. DF AT +25 °C, 120 Hz (%)	MAX. ESR AT +25 °C, 100 kHz (Ω)	MAX. RIPPLE, 100 kHz I _{RMS} (A)
4 V_{DC} AT +85 °C, 2.5 V_{DC} AT +125 °C						
4.7	A	TMCMA0G475(1)TRF	0.5	6	4.0	0.140
6.8	A	TMCMA0G685(1)TRF	0.5	6	4.0	0.140
10	A	TMCMA0G106(1)TRF	0.5	8	2.0	0.197
15	A	TMCMA0G156(1)TRF	0.6	8	2.9	0.164
15	B	TMCMB0G156(1)TRF	0.6	8	1.7	0.238
22	A	TMCMA0G226(1)TRF	0.9	8	1.8	0.208
22	B	TMCMB0G226(1)TRF	0.9	8	1.1	0.295
33	A	TMCMA0G336(1)TRF	1.3	8	2.0	0.197
33	B	TMCMB0G336(1)TRF	1.3	8	1.1	0.295
47	A	TMCMA0G476(1)TRF	1.9	12	2.0	0.197
47	B	TMCMB0G476(1)TRF	1.9	8	1.1	0.295
47	C	TMCMC0G476(1)TRF	1.9	8	1.1	0.302
68	A	TMCMA0G686(1)TRF	5.4	12	2.0	0.197
68	B	TMCMB0G686(1)TRF	2.7	8	1.1	0.295
68	C	TMCMC0G686(1)TRF	2.7	8	1.1	0.302
100	A	TMCMA0G107(1)TRF	8.0	30	1.1	0.266
100	B	TMCMB0G107(1)TRF	4.0	12	1.1	0.295
100	C	TMCMC0G107(1)TRF	4.0	8	1.1	0.302
100	E	TMCME0G107(1)TRF	4.0	8	0.6	0.447
150	A	TMCMA0G157(1)TRF	60.0	30	1.8	0.208
150	B	TMCMB0G157(1)TRF	6.0	18	1.1	0.295
150	C	TMCMC0G157(1)TRF	6.0	8	1.1	0.302
150	E	TMCME0G157(1)TRF	6.0	8	0.3	0.632
220	A	TMCMA0G227MTRF	88.0	30	1.8	0.208
220	B	TMCMB0G227(1)TRF	17.6	18	1.1	0.295
220	C	TMCMC0G227(1)TRF	8.8	12	1.1	0.302
220	E	TMCME0G227(1)TRF	8.8	8	0.3	0.632
330	B	TMCMB0G337MTRF	26.4	30	1.1	0.295
330	C	TMCMC0G337(1)TRF	13.2	18	1.1	0.302
330	E	TMCME0G337(1)TRF	13.2	10	0.3	0.632
470	E	TMCME0G477(1)TRF	18.8	16	0.2	0.775
6.3 V_{DC} (7 V_{DC}) AT +85 °C, 4 V_{DC} AT +125 °C						
3.3	A	TMCMA0J335(1)TRF	0.5	6	4.0	0.140
4.7	A	TMCMA0J475(1)TRF	0.5	6	4.0	0.140
6.8	A	TMCMA0J685(1)TRF	0.5	6	4.0	0.140
10	A	TMCMA0J106(1)TRF	0.7	8	2.9	0.164
10	B	TMCMB0J106(1)TRF	0.7	8	1.7	0.238
15	A	TMCMA0J156(1)TRF	1.1	8	4.0	0.140
15	B	TMCMB0J156(1)TRF	1.1	8	1.7	0.238
22	A	TMCMA0J226(1)TRF	1.5	8	1.8	0.208
22	B	TMCMB0J226(1)TRF	1.5	8	1.1	0.295
33	A	TMCMA0J336(1)TRF	2.3	10	2.0	0.197
33	B	TMCMB0J336(1)TRF	2.3	8	1.1	0.295
33	C	TMCMC0J336(1)TRF	2.3	8	1.1	0.302
47	A	TMCMA0J476(1)TRF	5.9	12	1.8	0.208
47	B	TMCMB0J476(1)TRF	3.3	8	1.1	0.295
47	C	TMCMC0J476(1)TRF	3.3	8	1.1	0.302
68	A	TMCMA0J686(1)TRF	8.6	20	2.0	0.197
68	B	TMCMB0J686(1)TRF	4.8	10	1.1	0.295
68	C	TMCMC0J686(1)TRF	4.8	8	1.1	0.302
68	E	TMCME0J686(1)TRF	4.8	8	0.6	0.447
100	A	TMCMA0J107MTRF	31.5	30	1.8	0.208

Note

- Part number definition:
(1) Tolerance: For 10 % tolerance, specify "K"; for 20 % tolerance, change to "M"



STANDARD RATINGS						
CAPACITANCE (μ F)	CASE CODE	PART NUMBER	MAX. DCL AT +25 °C (μ A)	MAX. DF AT +25 °C, 120 Hz (%)	MAX. ESR AT +25 °C, 100 kHz (Ω)	MAX. RIPPLE, 100 kHz I _{RMS} (A)
6.3 V_{DC} (7 V_{DC}) AT +85 °C, 4 V_{DC} AT +125 °C						
100	B	TMCMB0J107(1)TRF	7.0	12	1.1	0.295
100	C	TMCMC0J107(1)TRF	7.0	8	1.1	0.302
100	E	TMCME0J107(1)TRF	7.0	8	0.6	0.447
150	B	TMCMB0J157(1)TRF	18.9	20	1.1	0.295
150	C	TMCMC0J157(1)TRF	10.5	10	1.1	0.302
150	E	TMCME0J157(1)TRF	10.5	8	0.3	0.632
220	B	TMCMB0J227MTRF	27.7	30	1.1	0.295
220	C	TMCMC0J227(1)TRF	15.4	18	1.1	0.302
220	E	TMCME0J227(1)TRF	15.4	10	0.3	0.632
330	C	TMCMC0J337MTRF	23.1	30	1.1	0.302
330	E	TMCME0J337(1)TRF	23.1	16	0.2	0.775
470	E	TMCME0J477(1)TRF	32.9	20	0.3	0.632
10 V_{DC} AT +85 °C, 6.3 V_{DC} AT +125 °C						
2.2	A	TMCMA1A225(1)TRF	0.5	6	4.4	0.133
3.3	A	TMCMA1A335(1)TRF	0.5	6	4.0	0.140
4.7	A	TMCMA1A475(1)TRF	0.5	6	4.0	0.140
6.8	A	TMCMA1A685(1)TRF	0.7	6	4.0	0.140
6.8	B	TMCMB1A685(1)TRF	0.7	6	2.8	0.185
10	A	TMCMA1A106(1)TRF	1.0	8	2.9	0.164
10	B	TMCMB1A106(1)TRF	1.0	8	1.7	0.238
15	A	TMCMA1A156(1)TRF	1.5	8	2.9	0.164
15	B	TMCMB1A156(1)TRF	1.5	8	1.7	0.238
22	A	TMCMA1A226(1)TRF	4.4	12	2.4	0.180
22	B	TMCMB1A226(1)TRF	2.2	8	1.1	0.295
22	C	TMCMC1A226(1)TRF	2.2	8	1.7	0.243
33	A	TMCMA1A336(1)TRF	6.6	18	2.0	0.197
33	B	TMCMB1A336(1)TRF	3.3	8	1.1	0.295
33	C	TMCMC1A336(1)TRF	3.3	8	1.1	0.302
47	A	TMCMA1A476MTRF	9.4	20	2.6	0.173
47	B	TMCMB1A476(1)TRF	4.7	10	1.1	0.295
47	C	TMCMC1A476(1)TRF	4.7	8	1.1	0.302
47	E	TMCME1A476(1)TRF	4.7	8	0.9	0.365
68	B	TMCMB1A686(1)TRF	6.8	18	1.1	0.295
68	C	TMCMC1A686(1)TRF	6.8	8	1.1	0.302
68	E	TMCME1A686(1)TRF	6.8	8	0.6	0.447
100	B	TMCMB1A107MTRF	20.0	30	1.7	0.238
100	C	TMCMC1A107(1)TRF	10.0	10	1.1	0.302
100	E	TMCME1A107(1)TRF	10.0	8	0.6	0.447
150	C	TMCMC1A157MTRF	15.0	18	1.1	0.302
150	E	TMCME1A157(1)TRF	15.0	8	0.3	0.632
220	E	TMCME1A227(1)TRF	22.0	12	0.2	0.775
330	E	TMCME1A337(1)TRF	33.0	30	0.3	0.632

Note

- Part number definition:
(1) Tolerance: For 10 % tolerance, specify "K"; for 20 % tolerance, change to "M"



STANDARD RATINGS						
CAPACITANCE (μF)	CASE CODE	PART NUMBER	MAX. DCL AT +25 °C (μA)	MAX. DF AT +25 °C, 120 Hz (%)	MAX. ESR AT +25 °C, 100 kHz (Ω)	MAX. RIPPLE, 100 kHz I _{RMS} (A)
16 V_{DC} AT +85 °C, 10 V_{DC} AT +125 °C						
1.5	A	TMCMA1C155(1)TRF	0.5	6	6.6	0.109
2.2	A	TMCMA1C225(1)TRF	0.5	6	6.6	0.109
3.3	A	TMCMA1C335(1)TRF	0.5	6	4.0	0.140
4.7	A	TMCMA1C475(1)TRF	0.8	6	4.0	0.140
4.7	B	TMCMB1C475(1)TRF	0.8	6	2.8	0.185
6.8	A	TMCMA1C685(1)TRF	1.1	6	4.0	0.140
6.8	B	TMCMB1C685(1)TRF	1.1	6	2.8	0.185
10	A	TMCMA1C106(1)TRF	1.6	8	2.9	0.164
10	B	TMCMB1C106(1)TRF	1.6	8	1.7	0.238
15	A	TMCMA1C156(1)TRF	2.4	12	2.9	0.164
15	B	TMCMB1C156(1)TRF	2.4	8	1.7	0.238
15	C	TMCMC1C156(1)TRF	2.4	8	1.7	0.243
22	A	TMCMA1C226MTRF	7.0	16	2.9	0.164
22	B	TMCMB1C226(1)TRF	3.5	8	1.7	0.238
22	C	TMCMC1C226(1)TRF	3.5	8	1.1	0.302
33	B	TMCMB1C336(1)TRF	5.3	12	1.1	0.295
33	C	TMCMC1C336(1)TRF	5.3	8	1.1	0.302
33	E	TMCME1C336(1)TRF	5.3	8	0.9	0.365
47	B	TMCMB1C476MTRF	7.5	20	1.7	0.238
47	C	TMCMC1C476(1)TRF	7.5	8	2.2	0.213
47	E	TMCME1C476(1)TRF	7.5	8	0.9	0.365
68	C	TMCMC1C686(1)TRF	10.9	20	1.1	0.302
68	E	TMCME1C686(1)TRF	10.9	8	0.6	0.447
100	C	TMCMC1C107MTRF	16.0	20	1.7	0.243
100	E	TMCME1C107(1)TRF	16.0	8	0.6	0.447
20 V_{DC} AT +85 °C, 13 V_{DC} AT +125 °C						
1.0	A	TMCMA1D105(1)TRF	0.5	4	6.6	0.109
1.5	A	TMCMA1D155(1)TRF	0.5	6	4.4	0.133
2.2	A	TMCMA1D225(1)TRF	0.5	6	4.4	0.133
3.3	A	TMCMA1D335(1)TRF	0.7	6	4.0	0.140
3.3	B	TMCMB1D335(1)TRF	0.7	6	3.9	0.157
4.7	A	TMCMA1D475(1)TRF	0.9	6	4.0	0.140
4.7	B	TMCMB1D475(1)TRF	0.9	6	2.8	0.185
6.8	B	TMCMB1D685(1)TRF	1.4	6	2.2	0.209
10	B	TMCMB1D106(1)TRF	2.0	8	2.2	0.209
10	C	TMCMC1D106(1)TRF	2.0	8	1.7	0.243
15	B	TMCMB1D156(1)TRF	3.0	8	1.1	0.295
15	C	TMCMC1D156(1)TRF	3.0	8	1.7	0.243
22	B	TMCMB1D226(1)TRF	4.4	8	1.7	0.238
22	C	TMCMC1D226(1)TRF	4.4	8	1.7	0.243
22	E	TMCME1D226(1)TRF	4.4	8	0.9	0.365
33	C	TMCMC1D336(1)TRF	6.6	8	1.0	0.316
33	E	TMCME1D336(1)TRF	6.6	8	0.9	0.365
47	E	TMCME1D476(1)TRF	9.4	8	0.9	0.365
68	E	TMCME1D686(1)TRF	13.6	8	0.5	0.490

Note

- Part number definition:
 - (1) Tolerance: For 10 % tolerance, specify "K"; for 20 % tolerance, change to "M"



STANDARD RATINGS						
CAPACITANCE (μ F)	CASE CODE	PART NUMBER	MAX. DCL AT +25 °C (μ A)	MAX. DF AT +25 °C, 120 Hz (%)	MAX. ESR AT +25 °C, 100 kHz (Ω)	MAX. RIPPLE, 100 kHz I _{RMS} (A)
25 V_{DC} AT +85 °C, 16 V_{DC} AT +125 °C						
0.68	A	TMCMA1E684(1)TRF	0.5	4	9.7	0.090
1.0	A	TMCMA1E105(1)TRF	0.5	4	6.6	0.109
1.5	A	TMCMA1E155(1)TRF	0.5	6	4.4	0.133
2.2	A	TMCMA1E225(1)TRF	0.6	6	4.4	0.133
2.2	B	TMCMB1E225(1)TRF	0.6	6	3.9	0.157
3.3	A	TMCMA1E335(1)TRF	0.8	6	2.8	0.167
3.3	B	TMCMB1E335(1)TRF	0.8	6	3.9	0.157
4.7	A	TMCMA1E475MTRF	1.2	6	6.6	0.109
4.7	B	TMCMB1E475(1)TRF	1.2	6	2.8	0.185
6.8	B	TMCMB1E685(1)TRF	1.7	8	2.8	0.185
6.8	C	TMCMC1E685(1)TRF	1.7	8	1.7	0.243
10	B	TMCMB1E106(1)TRF	2.5	8	2.2	0.209
10	C	TMCMC1E106(1)TRF	2.5	8	1.7	0.243
15	C	TMCMC1E156(1)TRF	3.8	8	1.7	0.243
15	E	TMCME1E156(1)TRF	3.8	8	0.9	0.365
22	C	TMCMC1E226(1)TRF	5.5	8	1.1	0.302
22	E	TMCME1E226(1)TRF	5.5	8	0.9	0.365
33	E	TMCME1E336(1)TRF	8.3	8	0.9	0.365
47	E	TMCME1E476(1)TRF	11.8	8	0.9	0.365
35 V_{DC} AT +85 °C, 22 V_{DC} AT +125 °C						
0.47	A	TMCMA1V474(1)TRF	0.5	4	16.5	0.069
0.68	A	TMCMA1V684(1)TRF	0.5	4	9.7	0.090
1.0	A	TMCMA1V105(1)TRF	0.5	4	6.6	0.109
1.5	A	TMCMA1V155(1)TRF	0.5	6	4.4	0.133
1.5	B	TMCMB1V155(1)TRF	0.5	6	3.9	0.157
2.2	A	TMCMA1V225MTRF	0.8	8	4.4	0.133
2.2	B	TMCMB1V225(1)TRF	0.8	6	5.5	0.132
3.3	B	TMCMB1V335(1)TRF	1.2	6	3.9	0.157
4.7	C	TMCMC1V475(1)TRF	1.6	6	2.8	0.189
6.8	C	TMCMC1V685(1)TRF	2.4	6	1.7	0.243
10	C	TMCMC1V106(1)TRF	3.5	8	1.7	0.243
10	E	TMCME1V106(1)TRF	3.5	8	1.1	0.330
15	E	TMCME1V156(1)TRF	5.3	8	0.9	0.365
22	E	TMCME1V226(1)TRF	7.7	8	0.9	0.365

Note

- Part number definition:
 - (1) Tolerance: For 10 % tolerance, specify "K"; for 20 % tolerance, change to "M"

RECOMMENDED VOLTAGE DERATING GUIDELINES (for temperature below +85 °C)	
CAPACITOR VOLTAGE RATING	OPERATING VOLTAGE
2.5	1.2
4.0	2.0
6.3 (7.0)	3.1 (3.5)
10	5.0
16	8.0
20	10.0
25	12.5
35	17.5

Note

- For more information about recommended voltage derating see technical note www.vishay.com/doc?40246



POWER DISSIPATION	
CASE CODE	MAXIMUM PERMISSIBLE POWER DISSIPATION AT +25 °C (W) IN FREE AIR
A	0.078
B	0.096
C	0.100
E	0.120

STANDARD PACKAGING QUANTITY	
CASE CODE	UNITS PER 7" REEL
A	2000
B	2000
C	500
E	500

PERFORMANCE CHARACTERISTICS						
ITEM	CONDITION	POST TEST PERFORMANCE				
			Specified initial value	-55 °C	+85 °C	+125 °C
Temperature characteristics	Measure the specified characteristics in each stage	Capacitance change	-	-10 % to 0 %	0 % to +10 %	0 % to +12 %
		Dissipation factor (%)	4	9	7	9
			6	10	8	10
			8	12	10	12
			10	14	12	14
			12	16	14	16
			16	20	18	20
			18	34	20	22
			20	36	22	24
		30	60	30	40	
Leakage current	Refer to Standard Ratings table	-	1000 % specified initial value or less	1250 % specified initial value or less		
Solder heat resistance	Solder dip: 260 °C ± 5 °C A, B case: 10 s ± 1 s C, E case: 5 s ± 0.5 s Reflow 260 °C, 10 s ± 1 s	Capacitance change	Within ± 5 % of initial value			
		Dissipation factor	Shall not exceed initial specified value			
		Leakage current	Shall not exceed initial specified value			
Moisture resistance no load	Leave at 40 °C and 90 % to 95 % RH for 500 h	Capacitance change	Within ± 10 % of initial value			
		Dissipation factor	Shall not exceed initial specified value			
		Leakage current	Shall not exceed initial specified value			
High temperature load	85 °C. The rated voltage is applied for 2000 h	Capacitance change	Within ± 10 % of initial value			
		Dissipation factor	Shall not exceed initial specified value			
		Leakage current	Shall not exceed 125 % of initial specified value			
Thermal shock	Leave at -55 °C, normal temperature, 125 °C, and normal temperature for 30 min, 3 min, 30 min, and 3 min. Repeat this operation 5 times running	Capacitance change	Within ± 10 % of initial value			
		Dissipation factor	Shall not exceed initial specified value			
		Leakage current	Shall not exceed initial specified value			
Moisture resistance load	Leave at 40 °C and 90 % to 95 % RH. The rated voltage applied for 500 h	Capacitance change	Within ± 10 % of initial value			
		Dissipation factor	Shall not exceed 150 % of initial specified value			
		Leakage current	Shall not exceed 200 % of initial specified value			
Failure rate	85 °C. The rated voltage is applied through a protective resistor of 1 Ω/V	1 %/1000 h				

Note

- Test conditions per JIS C5101-1



Guide for Tantalum Solid Electrolyte Chip Capacitors

INTRODUCTION

Tantalum electrolytic capacitors are the preferred choice in applications where volumetric efficiency, stable electrical parameters, high reliability, and long service life are primary considerations. The stability and resistance to elevated temperatures of the tantalum / tantalum oxide / manganese dioxide system make solid tantalum capacitors an appropriate choice for today's surface mount assembly technology.

Vishay Sprague has been a pioneer and leader in this field, producing a large variety of tantalum capacitor types for consumer, industrial, automotive, military, and aerospace electronic applications.

Tantalum is not found in its pure state. Rather, it is commonly found in a number of oxide minerals, often in combination with Columbium ore. This combination is known as "tantalite" when its contents are more than one-half tantalum. Important sources of tantalite include Australia, Brazil, Canada, China, and several African countries. Synthetic tantalite concentrates produced from tin slags in Thailand, Malaysia, and Brazil are also a significant raw material for tantalum production.

Electronic applications, and particularly capacitors, consume the largest share of world tantalum production. Other important applications for tantalum include cutting tools (tantalum carbide), high temperature super alloys, chemical processing equipment, medical implants, and military ordnance.

Vishay Sprague is a major user of tantalum materials in the form of powder and wire for capacitor elements and rod and sheet for high temperature vacuum processing.

THE BASICS OF TANTALUM CAPACITORS

Most metals form crystalline oxides which are non-protecting, such as rust on iron or black oxide on copper. A few metals form dense, stable, tightly adhering, electrically insulating oxides. These are the so-called "valve" metals and include titanium, zirconium, niobium, tantalum, hafnium, and aluminum. Only a few of these permit the accurate control of oxide thickness by electrochemical means. Of these, the most valuable for the electronics industry are aluminum and tantalum.

Capacitors are basic to all kinds of electrical equipment, from radios and television sets to missile controls and automobile ignitions. Their function is to store an electrical charge for later use.

Capacitors consist of two conducting surfaces, usually metal plates, whose function is to conduct electricity. They are separated by an insulating material or dielectric. The dielectric used in all tantalum electrolytic capacitors is tantalum pentoxide.

Tantalum pentoxide compound possesses high-dielectric strength and a high-dielectric constant. As capacitors are being manufactured, a film of tantalum pentoxide is applied to their electrodes by means of an electrolytic process. The film is applied in various thicknesses and at various voltages and although transparent to begin with, it takes on different colors as light refracts through it. This coloring occurs on the tantalum electrodes of all types of tantalum capacitors.

Rating for rating, tantalum capacitors tend to have as much as three times better capacitance / volume efficiency than aluminum electrolytic capacitors. An approximation of the capacitance / volume efficiency of other types of capacitors may be inferred from the following table, which shows the dielectric constant ranges of the various materials used in each type. Note that tantalum pentoxide has a dielectric constant of 26, some three times greater than that of aluminum oxide. This, in addition to the fact that extremely thin films can be deposited during the electrolytic process mentioned earlier, makes the tantalum capacitor extremely efficient with respect to the number of microfarads available per unit volume. The capacitance of any capacitor is determined by the surface area of the two conducting plates, the distance between the plates, and the dielectric constant of the insulating material between the plates.

COMPARISON OF CAPACITOR DIELECTRIC CONSTANTS	
DIELECTRIC	ϵ DIELECTRIC CONSTANT
Air or vacuum	1.0
Paper	2.0 to 6.0
Plastic	2.1 to 6.0
Mineral oil	2.2 to 2.3
Silicone oil	2.7 to 2.8
Quartz	3.8 to 4.4
Glass	4.8 to 8.0
Porcelain	5.1 to 5.9
Mica	5.4 to 8.7
Aluminum oxide	8.4
Tantalum pentoxide	26
Ceramic	12 to 400K

In the tantalum electrolytic capacitor, the distance between the plates is very small since it is only the thickness of the tantalum pentoxide film. As the dielectric constant of the tantalum pentoxide is high, the capacitance of a tantalum capacitor is high if the area of the plates is large:

$$C = \frac{\epsilon A}{t}$$

where

C = capacitance

ϵ = dielectric constant

A = surface area of the dielectric

t = thickness of the dielectric

Tantalum capacitors contain either liquid or solid electrolytes. In solid electrolyte capacitors, a dry material (manganese dioxide) forms the cathode plate. A tantalum lead is embedded in or welded to the pellet, which is in turn connected to a termination or lead wire. The drawings show the construction details of the surface mount types of tantalum capacitors shown in this catalog.

SOLID ELECTROLYTE TANTALUM CAPACITORS

Solid electrolyte capacitors contain manganese dioxide, which is formed on the tantalum pentoxide dielectric layer by impregnating the pellet with a solution of manganous nitrate. The pellet is then heated in an oven, and the manganous nitrate is converted to manganese dioxide.

The pellet is next coated with graphite, followed by a layer of metallic silver, which provides a conductive surface between the pellet and the leadframe.

Molded chip tantalum capacitor encases the element in plastic resins, such as epoxy materials. After assembly, the capacitors are tested and inspected to ensure long life and reliability. It offers excellent reliability and high stability for consumer and commercial electronics with the added feature of low cost.

Surface mount designs of "Solid Tantalum" capacitors use lead frames as shown in the accompanying drawings.

TANTALUM CAPACITORS FOR ALL DESIGN CONSIDERATIONS

Solid electrolyte designs are the least expensive for a given rating and are used in many applications where their very small size for a given unit of capacitance is of importance. Also important are their good low temperature performance characteristics and freedom from corrosive electrolytes.

Datasheets covering the various types and styles of capacitors for consumer and entertainment electronics and industry applications are available where detailed performance characteristics must be specified.

MOLDED CHIP CAPACITOR, ALL TYPES EXCEPT TMCTX / TMCJ

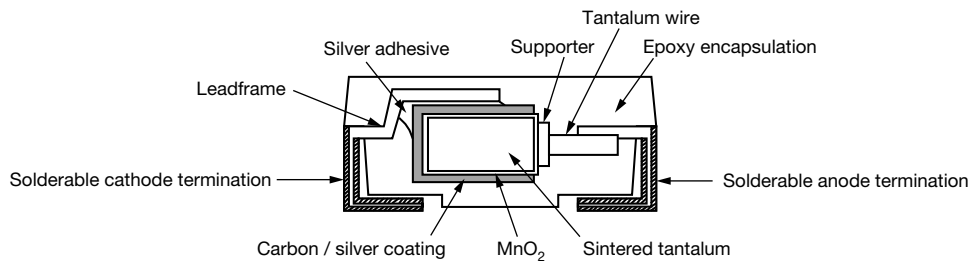

MOLDED CHIP CAPACITOR WITH BUILT-IN FUSE, TYPE TMCTX

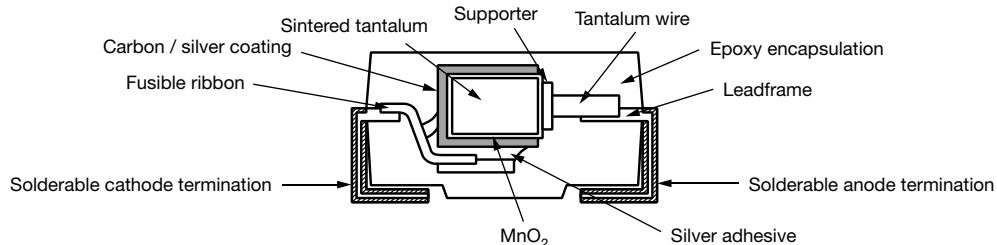

MOLDED CHIP CAPACITOR 0603 SIZE, TYPE TMCJ

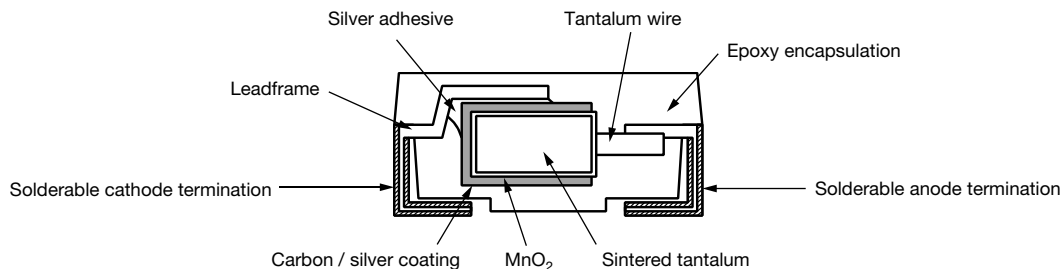

SOLID TANTALUM CAPACITORS - MOLDED CASE						
SERIES	TMCS	TMCM	TMCR	TMCU	TMCP	TMCJ
PRODUCT IMAGE						
TYPE	Solid tantalum surface mount chip capacitors, molded case					
FEATURES	Standard industrial grade	Standard industrial grade extended range	Low ESR	Low profile	0805 size	0603 size
TEMPERATURE RANGE	-55 °C to +125 °C					
CAPACITANCE RANGE	0.1 µF to 68 µF	0.47 µF to 470 µF	10 µF to 330 µF	0.1 µF to 220 µF	0.1 µF to 47 µF	0.68 µF to 22 µF
VOLTAGE RANGE	4 V to 35 V	2.5 V to 35 V	7 V to 35 V	2.5 V to 35 V	2.5 V to 25 V	2.5 V to 20 V
CAPACITANCE TOLERANCE	± 10 %, ± 20 %					± 20 %
LEAKAGE CURRENT	0.01 CV or 0.5 µA, whichever is greater					
DISSIPATION FACTOR	4 % to 6 %	4 % to 30 %	6 % to 30 %	4 % to 30 %	6 % to 30 %	20 %
CASE SIZES	A, B, C, E	A, B, C, E	B, C, E	UA, UB	P	J
TERMINATION FINISH	100 % tin			Case UA: 100 % tin Case UB: Ni / Pd / Au	100 % tin	

SOLID TANTALUM CAPACITORS - MOLDED CASE			
SERIES	TMCTX	TMCH	THC
PRODUCT IMAGE			
TYPE	Solid tantalum surface mount chip capacitors, molded case		
FEATURES	Built-in fuse	High reliability	High reliability, high temperature +150 °C
TEMPERATURE RANGE	-55 °C to +125 °C		-55 °C to +150 °C
CAPACITANCE RANGE	1.0 µF to 68 µF	0.1 µF to 100 µF	0.33 µF to 47 µF
VOLTAGE RANGE	10 V to 35 V	4 V to 35 V	10 V to 35 V
CAPACITANCE TOLERANCE	± 10 %, ± 20 %		
LEAKAGE CURRENT	0.01 CV or 0.5 µA, whichever is greater	0.005 CV or 0.25 µA, whichever is greater	
DISSIPATION FACTOR	4 % to 6 %	4 % to 8 %	4 % to 6 %
CASE SIZES	B, C, E, F	A, B, C, E, P	A, B, C, E
TERMINATION FINISH	100 % tin		

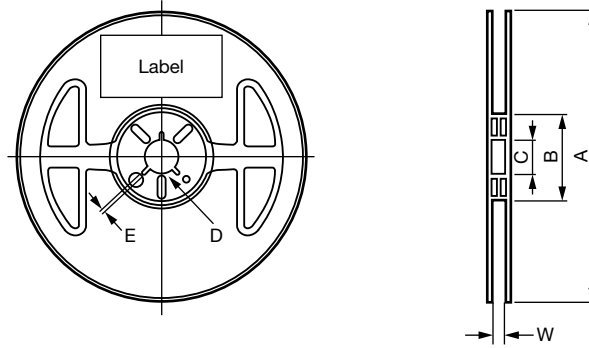
PLASTIC TAPE AND REEL PACKAGING DIMENSIONS in millimeters

CASE CODE	J, P, A, UA, B, UB	C, E, F
TAPE WIDTH	8	12
A + 0 / - 3		Ø 180
B + 1 / 0		Ø 60
C ± 0.2		Ø 13
D ± 0.5		Ø 21
E ± 0.5		2.0
W ± 0.3	9.0	13.0

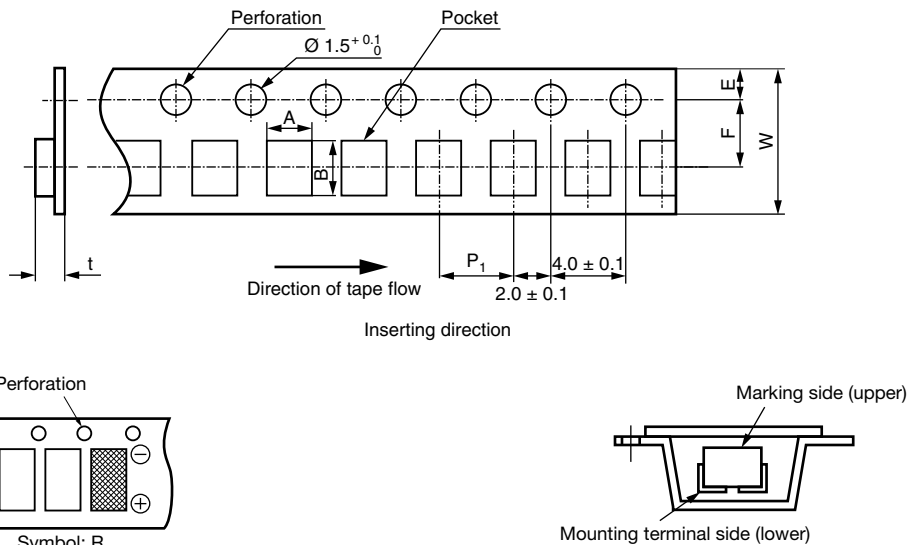
TAPE SIZE in millimeters

CASE CODE	A ± 0.2	B ± 0.2	W ± 0.3	F ± 0.1	E ± 0.1	P ₁ ± 0.1	t _{max.}
J	1.0	1.8	8.0	3.5	1.75	4.0	1.3
P	1.4	2.2	8.0	3.5	1.75	4.0	1.6
A	1.9	3.5	8.0	3.5	1.75	4.0	2.5
UA	1.9	3.5	8.0	3.5	1.75	4.0	1.7
B	3.1	3.8	8.0	3.5	1.75	4.0	2.5
UB	3.1	3.8	8.0	3.5	1.75	4.0	1.7
C	3.7	6.3	12.0	5.5	1.75	8.0	3.1
E	4.8	7.7	12.0	5.5	1.75	8.0	3.4
F	6.2	7.5	12.0	5.5	1.75	8.0	4.1

RECOMMENDED REFLOW PROFILES

Capacitors should withstand reflow profile as per J-STD-020 standard

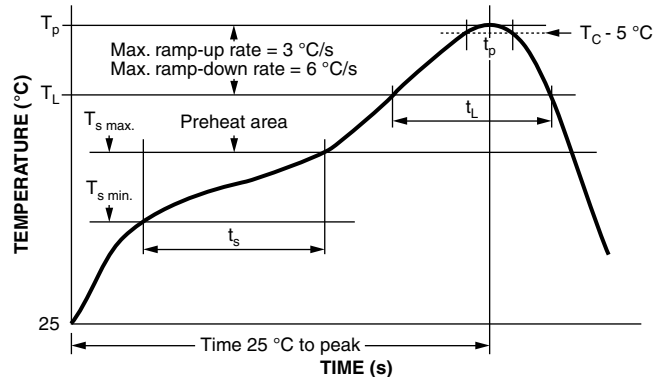

PROFILE FEATURE	LEAD (Pb)-FREE ASSEMBLY
Preheat / soak	
Temperature min. ($T_{s \text{ min.}}$)	130 °C
Temperature max. ($T_{s \text{ max.}}$)	160 °C
Time (t_s) from ($T_{s \text{ min.}}$ to $T_{s \text{ max.}}$)	60 s to 120 s
Ramp-up	
Ramp-up rate (T_L to T_p)	3 °C/s max.
Liquidus temperature (T_L)	200 °C
Time (t_L) maintained above T_L	50 s max.
Peak package body temperature (T_p) max.	Depends on case size - see table below
Time (t_p) within 5 °C of the peak maximum temperature	10 s max.
Ramp-down rate (T_p to T_L)	6 °C/s max.
Time from 25 °C to peak temperature	8 min max.

PEAK PACKAGE BODY TEMPERATURE (T_p)

CASE CODE	PEAK PACKAGE BODY TEMPERATURE (T_p)
	LEAD (Pb)-FREE PROCESS
J, P, UA, A, UB, B, C	260 °C
E, F	250 °C

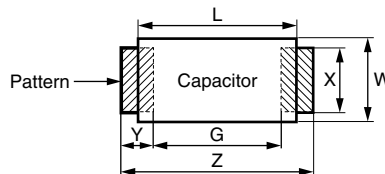
PAD DIMENSIONS in millimeters

CASE / DIMENSIONS	CAPACITOR SIZE		PAD DIMENSIONS			
	L	W	G (max.)	Z (min.)	X (min.)	Y (Ref.)
J	1.6	0.8	0.7	2.5	1.0	0.9
P	2.0	1.25	0.5	2.6	1.2	1.05
UA, A	3.2	1.6	1.1	3.8	1.5	1.35
UB, B	3.5	2.8	1.4	4.1	2.7	1.35
C	5.8	3.2	2.9	6.9	2.7	2.0
E	7.3	4.3	4.1	8.2	2.9	2.05
F	7.3	5.8	4.1	8.2	4.0	2.05

GUIDE TO APPLICATION

- AC Ripple Current:** the maximum allowable ripple current shall be determined from the formula:

$$I_{RMS} = \sqrt{\frac{P}{R_{ESR}}}$$

where,

P = power dissipation in W at +25 °C as given in the tables in the product datasheets.

R_{ESR} = the capacitor equivalent series resistance at the specified frequency.

- AC Ripple Voltage:** the maximum allowable ripple voltage shall be determined from the formula:

$$V_{RMS} = Z \sqrt{\frac{P}{R_{ESR}}}$$

or, from the formula:

$$V_{RMS} = I_{RMS} \times Z$$

where,

P = power dissipation in W at +25 °C as given in the tables in the product datasheets.

R_{ESR} = The capacitor equivalent series resistance at the specified frequency.

Z = The capacitor impedance at the specified frequency.

- The tantalum capacitors must be used in such a condition that the sum of the working voltage and ripple voltage peak values does not exceed the rated voltage as shown in figure below.

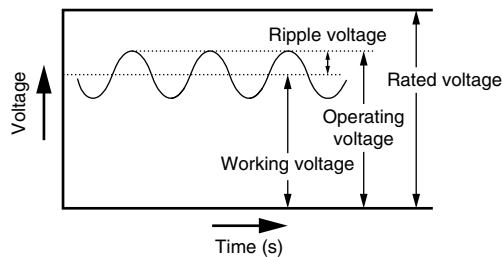

- Temperature Derating:** power dissipation is affected by the heat sinking capability of the mounting surface. If these capacitors are to be operated at temperatures above +25 °C, the permissible ripple current (or voltage) shall be calculated using the derating coefficient as shown in the table below:

MAXIMUM RIPPLE CURRENT TEMPERATURE DERATING FACTOR	
TEMPERATURE	TMC
≤ 25 °C	1.0
85 °C	0.9
105 °C	0.65
125 °C	0.4

- Reverse Voltage:** the capacitors are not intended for use with reverse voltage applied. If the application of a reverse voltage is unavoidable, it must not exceed the following values:

At 25 °C: 10 % of the rated voltage or 1 V, whichever is smaller.

At 85 °C: 5 % of the rated voltage or 0.5 V, whichever is smaller.

- Mounting Precautions:**

- Limit Pressure on Capacitor Installation with Mounter:** pressure must not exceed 4.9 N with a tool end diameter of 1.5 mm when applied to the capacitors using an absorber, centering tweezers, or similar (maximum permitted pressurization time: 5 s). An excessively low absorber setting position would result in not only the application of undue force to the capacitors but capacitor and other component scattering, circuit board wiring breakage, and / or cracking as well, particularly when the capacitors are mounted together with other chips having a height of 1 mm or less.

- Flux Selection**

- 5.2.1 Select a flux that contains a minimum of chlorine and amine.

- 5.2.2 After flux use, the chlorine and amine in the flux remain must be removed.

- 5.3 **Cleaning After Mounting:** the following solvents are usable when cleaning the capacitors after mounting. Never use a highly active solvent.

- Halogen organic solvent (HCFC225, etc.)
- Alcoholic solvent (IPA, ethanol, etc.)
- Petroleum solvent, alkali saponifying agent, water, etc.

Circuit board cleaning must be conducted at a temperature of not higher than 50 °C and for an immersion time of not longer than 30 minutes. When an ultrasonic cleaning method is used, cleaning must be conducted at a frequency of 48 kHz or lower, at a vibrator output of 0.02 W/cm³, at a temperature of not higher than 40 °C, and for a time of 5 minutes or shorter.

Notes

- Care must be exercised in cleaning process so that the mounted capacitor will not come into contact with any cleaned object or the like or will not get rubbed by a stiff brush or similar. If such precautions are not taken particularly when the ultrasonic cleaning method is employed, terminal breakage may occur
- When performing ultrasonic cleaning under conditions other than stated above, conduct adequate advance checkout



Disclaimer

ALL PRODUCT, PRODUCT SPECIFICATIONS AND DATA ARE SUBJECT TO CHANGE WITHOUT NOTICE TO IMPROVE RELIABILITY, FUNCTION OR DESIGN OR OTHERWISE.

Vishay Intertechnology, Inc., its affiliates, agents, and employees, and all persons acting on its or their behalf (collectively, "Vishay"), disclaim any and all liability for any errors, inaccuracies or incompleteness contained in any datasheet or in any other disclosure relating to any product.

Vishay makes no warranty, representation or guarantee regarding the suitability of the products for any particular purpose or the continuing production of any product. To the maximum extent permitted by applicable law, Vishay disclaims (i) any and all liability arising out of the application or use of any product, (ii) any and all liability, including without limitation special, consequential or incidental damages, and (iii) any and all implied warranties, including warranties of fitness for particular purpose, non-infringement and merchantability.

Statements regarding the suitability of products for certain types of applications are based on Vishay's knowledge of typical requirements that are often placed on Vishay products in generic applications. Such statements are not binding statements about the suitability of products for a particular application. It is the customer's responsibility to validate that a particular product with the properties described in the product specification is suitable for use in a particular application. Parameters provided in datasheets and / or specifications may vary in different applications and performance may vary over time. All operating parameters, including typical parameters, must be validated for each customer application by the customer's technical experts. Product specifications do not expand or otherwise modify Vishay's terms and conditions of purchase, including but not limited to the warranty expressed therein.

Hyperlinks included in this datasheet may direct users to third-party websites. These links are provided as a convenience and for informational purposes only. Inclusion of these hyperlinks does not constitute an endorsement or an approval by Vishay of any of the products, services or opinions of the corporation, organization or individual associated with the third-party website. Vishay disclaims any and all liability and bears no responsibility for the accuracy, legality or content of the third-party website or for that of subsequent links.

Except as expressly indicated in writing, Vishay products are not designed for use in medical, life-saving, or life-sustaining applications or for any other application in which the failure of the Vishay product could result in personal injury or death. Customers using or selling Vishay products not expressly indicated for use in such applications do so at their own risk. Please contact authorized Vishay personnel to obtain written terms and conditions regarding products designed for such applications.

No license, express or implied, by estoppel or otherwise, to any intellectual property rights is granted by this document or by any conduct of Vishay. Product names and markings noted herein may be trademarks of their respective owners.