

TMAG5124 2-Wire, High-Precision, Hall-Effect Switch Sensor

1 Features

- Hall effect switch with 2-wire interface
- Low-level current output options:
 - TMAG5124A/B/C/D: 3.5 mA
 - TMAG5124E/F/G/H: 6 mA
- Magnetic sensitivity:
 - TMAG5124A/E: 4 mT (typical)
 - TMAG5124B/F: 6 mT (typical)
 - TMAG5124C/G: 10 mT (typical)
 - TMAG5124D/H: 15 mT (typical)
- Fast sensing bandwidth: 40 kHz
- Supports wide voltage range
 - Operating V_{CC} range: 2.5 V to 38 V
 - No external regulator required
- Wide operating temperature range
 - Ambient operating temperature range: $-40\text{ }^{\circ}\text{C}$ to $+125\text{ }^{\circ}\text{C}$
- Protection features:
 - Supports load dump up to 40 V
 - Reverse polarity protection
- SOT-23 package option

2 Applications

- [Industrial robotics](#)
- [Factory automation & control](#)
- Fluid flow rate measurement
- [Medical devices](#)
- Off-board sensing

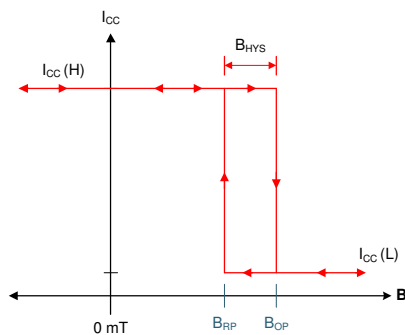

Output State

3 Description

The TMAG5124 device is a high-precision Hall effect sensor that offers a 2-wire interface designed for industrial designs.

The TMAG5124 integrates a current source that switches between two levels depending on the value of the magnetic field applied to the part. While the high value is fixed, the low value can be selected from two ranges. This type of interface enables robust communication between sensor and controller, allow long distance transmissions, helps detect disconnections, and limits the number of wires to two.

The device is available in a 3-pin SOT-23 package. While 3 pins are available on the package, the device only requires the VCC and GND pin to operate. The current can be measured from either of those 2 pins, creating either a high-side or low-side configuration.

Different product variants enable selection of different levels of magnetic sensitivity to match application specific requirements.

The wide operating voltage range and reverse polarity protection of the TMAG5124 is designed for a variety of industrial applications.

Device Information

PART NUMBER	PACKAGE ⁽¹⁾	BODY SIZE (NOM)
TMAG5124	SOT-23 (3)	2.92 mm × 1.30 mm

- (1) For all available packages, see the package option addendum at the end of the data sheet.

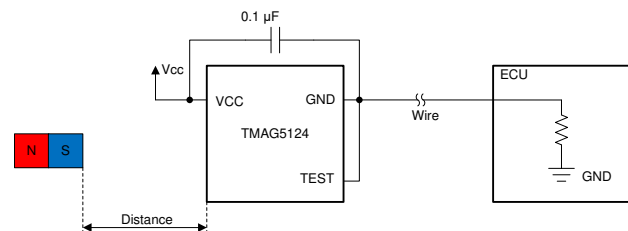

Typical Schematic



Table of Contents

1 Features	1	8.4 Device Functional Modes.....	16
2 Applications	1	9 Application and Implementation	17
3 Description	1	9.1 Application Information.....	17
4 Revision History	2	9.2 Typical Applications.....	17
5 Device Comparison Table	3	10 Power Supply Recommendations	20
6 Pin Configuration and Functions	3	10.1 Power Derating.....	20
7 Specifications	4	11 Layout	21
7.1 Absolute Maximum Ratings	4	11.1 Layout Guidelines.....	21
7.2 ESD Ratings	4	11.2 Layout Example.....	21
7.3 Recommended Operating Conditions	4	12 Device and Documentation Support	22
7.4 Thermal Information	4	12.1 Documentation Support.....	22
7.5 Electrical Characteristics	5	12.2 Receiving Notification of Documentation Updates..	22
7.6 Magnetic Characteristics	5	12.3 Support Resources.....	22
7.7 Typical Characteristics.....	6	12.4 Trademarks.....	22
8 Detailed Description	11	12.5 Electrostatic Discharge Caution.....	22
8.1 Overview.....	11	12.6 Glossary.....	22
8.2 Functional Block Diagram.....	11	13 Mechanical, Packaging, and Orderable	
8.3 Feature Description.....	11	Information	22

4 Revision History

Changes from Revision * (June 2020) to Revision A (October 2020)	Page
• Updated the numbering format for tables, figures, and cross-references throughout the document.....	1
• Changed data sheet status from Advanced Information to Production Data.....	1
• Changed data sheet title.....	1
• Added new orderables to the <i>Features</i> section.....	1
• Changed the <i>Device Comparison Table</i>	3
• Added graphs to the <i>Typical Characteristics</i> section	6
• Changed the <i>Overview</i> section.....	11
• Changed <i>Temperature coefficient</i> and <i>Output polarity control</i> blocks to: <i>Temperature compensation</i> and <i>Output control</i> in the <i>Functional Block Diagram</i>	11
• Changed Figure 8-6	14
• Added <i>Chopper Stabilization</i> section.....	16
• Changed Figure 10-1	20

5 Device Comparison Table

DEVICE	DEVICE OPTION	THRESHOLD LEVEL (BOP)	LOW-CURRENT LEVEL
TMAG5124	A1	4 mT	3.5 mA
	B1	6 mT	
	C1	10 mT	
	D1	15 mT	
	E1	4 mT	6 mA
	F1	6 mT	
	G1	10 mT	
	H1	15 mT	

6 Pin Configuration and Functions

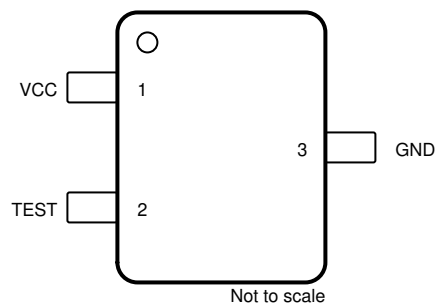

Figure 6-1. DBZ Package 3-Pin SOT-23 Top View

Table 6-1. Pin Functions

PIN		TYPE	DESCRIPTION
NO.	NAME		
1	VCC	Power supply	Power supply of 2.5 V to 38 V. Connect a ceramic capacitor with a value of at least 0.01 μ F between VCC and ground.
2	TEST	—	Must be connected to pin 3.
3	GND	Ground	Ground reference.

7 Specifications

7.1 Absolute Maximum Ratings

over operating free-air temperature range (unless otherwise noted)⁽¹⁾

		MIN	MAX	UNIT
Power Supply Voltage	V_{CC}	-20	40	V
Magnetic Flux Density, BMAX		Unlimited		T
Junction temperature	T_J		150	°C
Storage temperature, T_{stg}		-65	150	°C

- (1) Stresses beyond those listed under *Absolute Maximum Rating* may cause permanent damage to the device. These are stress ratings only, which do not imply functional operation of the device at these or any other conditions beyond those indicated under *Recommended Operating Condition*. Exposure to absolute-maximum-rated conditions for extended periods may affect device reliability.

7.2 ESD Ratings

			VALUE	UNIT
$V_{(ESD)}$	Electrostatic discharge	Human body model (HBM), per ANSI/ESDA/ JEDEC JS-001, all pins ⁽¹⁾	±2000	V
		Charged device model (CDM), per JEDEC specification JESD22-C101, all pins ⁽²⁾	± 500	

- (1) JEDEC document JEP155 states that 500-V HBM allows safe manufacturing with a standard ESD control process.
 (2) JEDEC document JEP157 states that 250-V CDM allows safe manufacturing with a standard ESD control process.

7.3 Recommended Operating Conditions

over operating free-air temperature range (unless otherwise noted)

		MIN	MAX	UNIT
V_{CC}	Power supply voltage	2.5	38	V
T_A	Ambient temperature	-40	125	°C

7.4 Thermal Information

THERMAL METRIC ⁽¹⁾		TMAG5124	UNIT
		DBV (SOT-23)	
		3 PINS	
$R_{\theta JA}$	Junction-to-ambient thermal resistance	198.5	°C/W
$R_{\theta JC(top)}$	Junction-to-case (top) thermal resistance	88.9	
$R_{\theta JB}$	Junction-to-board thermal resistance	28	
Ψ_{JT}	Junction-to-top characterization parameter	4	
Ψ_{JB}	Junction-to-board characterization parameter	27.7	
$R_{\theta JC(bot)}$	Junction-to-case (bottom) thermal resistance	—	°C/W

- (1) For more information about traditional and new thermal metrics, see the [Semiconductor and IC Package Thermal Metrics](#) application report.

7.5 Electrical Characteristics

over operating free-air temperature range (unless otherwise noted)

PARAMETER		TEST CONDITIONS	MIN	TYP	MAX	UNIT
POWER SUPPLY						
$I_{CC(L1)}$	Low-level supply current option 1	$V_{CC} = 2.5 \text{ V to } 38 \text{ V}$, $T_A = -40 \text{ }^\circ\text{C to } 125 \text{ }^\circ\text{C}$	2	3.5	5	mA
$I_{CC(L2)}$	Low-level supply current option 2	$V_{CC} = 2.5 \text{ V to } 38 \text{ V}$, $T_A = -40 \text{ }^\circ\text{C to } 125 \text{ }^\circ\text{C}$	5	6	7.3	
$I_{CC(H)}$	High-level supply current	$V_{CC} = 2.5 \text{ V to } 38 \text{ V}$, $T_A = -40 \text{ }^\circ\text{C to } 125 \text{ }^\circ\text{C}$	12	14.5	17	
I_{RCC}	Reverse supply current	$V_{RCC} = -20 \text{ V}$			-100	μA
t_{ON}	Power-on-time			62.5		μs
OUTPUT						
dI/dt	Supply Current Slew Rate	$V_{CC} = 12\text{V}$, $I_{CC(L)}$ to $I_{CC(H)}$, $I_{CC(H)}$ to $I_{CC(L)}$, $C_{BYP} = 0.01\mu\text{F}$		10		$\text{mA}/\mu\text{s}$
t_{PD}	Propagation delay time	Change in B field to change in output		12.5		μs
FREQUENCY RESPONSE						
f_{CHOP}	Chopping frequency			320		kHz
f_{BW}	Signal bandwidth			40		

7.6 Magnetic Characteristics

over operating free-air temperature range (unless otherwise noted)

PARAMETER		TEST CONDITIONS	MIN	TYP	MAX	UNIT
TMAG5124A, TMAG5124E						
B_{OP}	Magnetic field operating point	$V_{CC} = 2.5 \text{ V to } 38 \text{ V}$, $T_A = -40 \text{ }^\circ\text{C to } 125 \text{ }^\circ\text{C}$	3	4	5	mT
B_{RP}	Magnetic field release point		1	2	3	
B_{HYS}	Magnetic hysteresis $B_{OP} - B_{RP}$		0.6	2	3.4	
TMAG5124B, TMAG5124F						
B_{OP}	Magnetic field operating point	$V_{CC} = 2.5 \text{ V to } 38 \text{ V}$, $T_A = -40 \text{ }^\circ\text{C to } 125 \text{ }^\circ\text{C}$	5	6	7	mT
B_{RP}	Magnetic field release point		3	4	5	
B_{HYS}	Magnetic hysteresis $B_{OP} - B_{RP}$		0.6	2	3.4	
TMAG5124C, TMAG5124G						
B_{OP}	Magnetic field operating point	$V_{CC} = 2.5 \text{ V to } 38 \text{ V}$, $T_A = -40 \text{ }^\circ\text{C to } 125 \text{ }^\circ\text{C}$	8.8	10	11	mT
B_{RP}	Magnetic field release point		6.8	8	9.4	
B_{HYS}	Magnetic hysteresis $B_{OP} - B_{RP}$		0.6	2	3.4	
TMAG5124D, TMAG5124H						
B_{OP}	Magnetic field operating point	$V_{CC} = 2.5 \text{ V to } 38 \text{ V}$, $T_A = -40 \text{ }^\circ\text{C to } 125 \text{ }^\circ\text{C}$	13.6	15	16.1	mT
B_{RP}	Magnetic field release point		11.4	13	14.2	
B_{HYS}	Magnetic hysteresis $B_{OP} - B_{RP}$		0.6	2	3.4	

7.7 Typical Characteristics

7.7.1 TMAG5124A and TMAG5124E

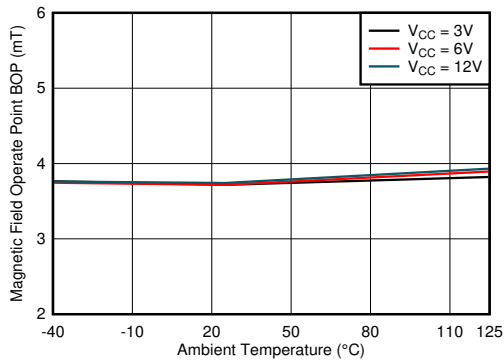

Figure 7-1. B_{OP} vs Temperature

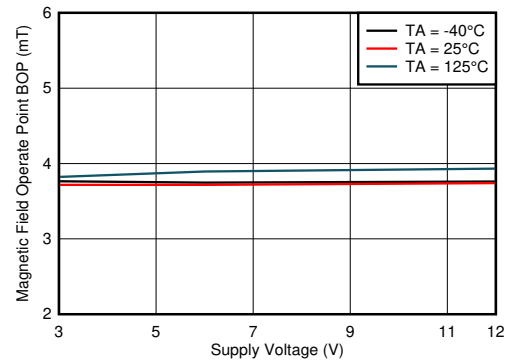

Figure 7-2. B_{OP} vs V_{CC}

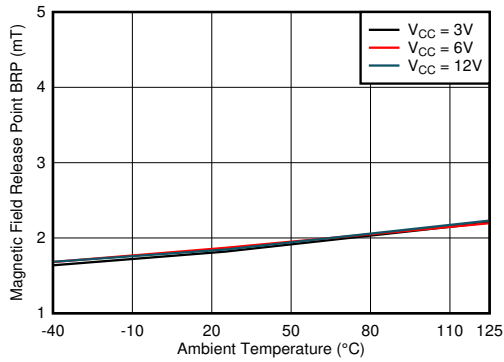

Figure 7-3. B_{RP} vs Temperature

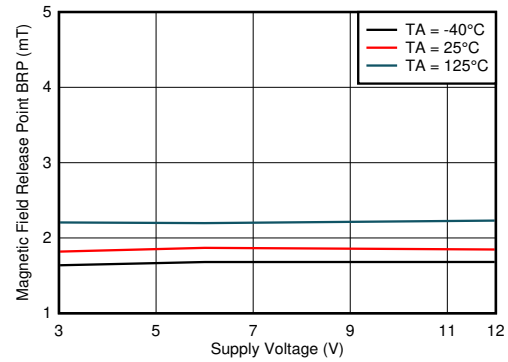

Figure 7-4. B_{RP} vs V_{CC}

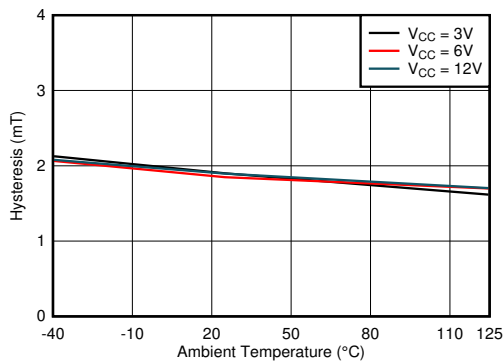

Figure 7-5. Hysteresis vs Temperature

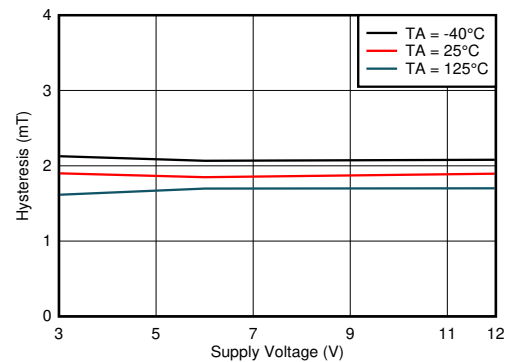

Figure 7-6. Hysteresis vs V_{CC}

7.7.2 TMAG5124B and TMAG5124F

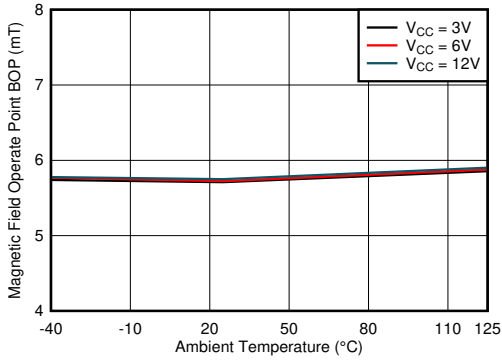

Figure 7-7. B_{OP} vs Temperature

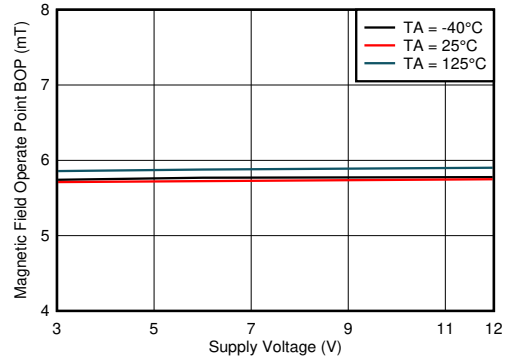

Figure 7-8. B_{OP} vs V_{CC}

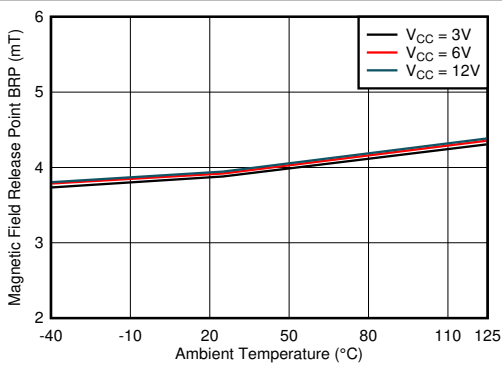

Figure 7-9. B_{RP} vs Temperature

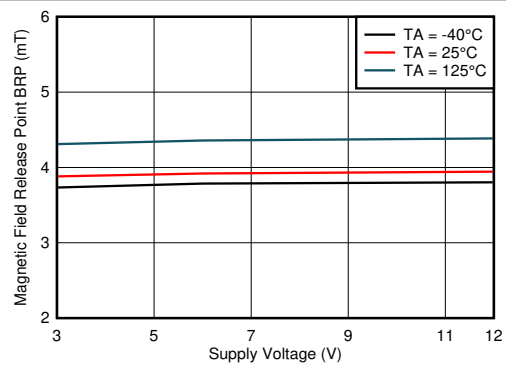

Figure 7-10. B_{RP} vs V_{CC}

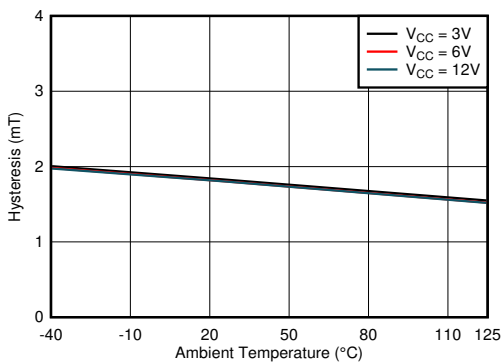

Figure 7-11. Hysteresis vs Temperature

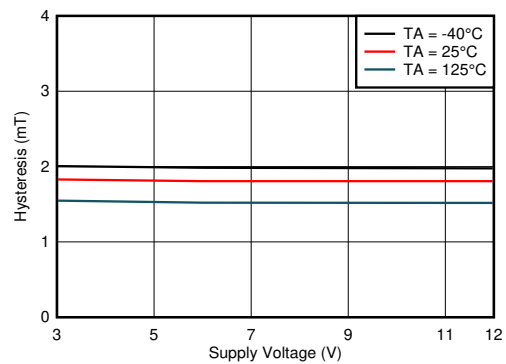

Figure 7-12. Hysteresis vs V_{CC}

7.7.3 TMAG5124C and TMAG5124G

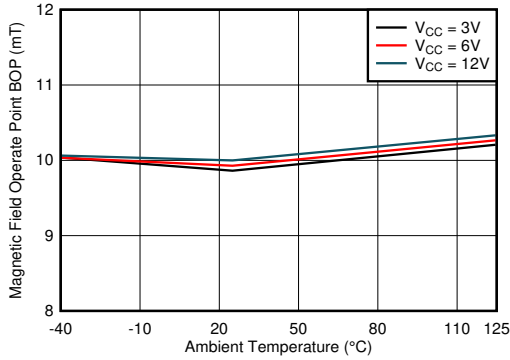

Figure 7-13. B_{OP} vs Temperature

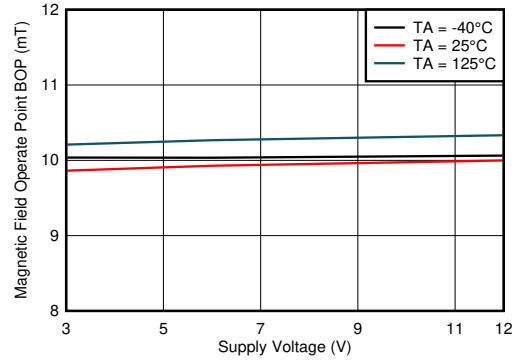

Figure 7-14. B_{OP} vs V_{CC}

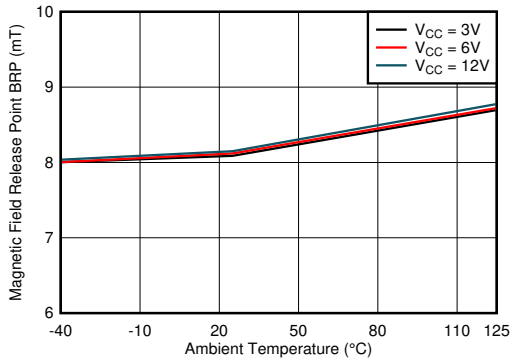

Figure 7-15. B_{RP} vs Temperature

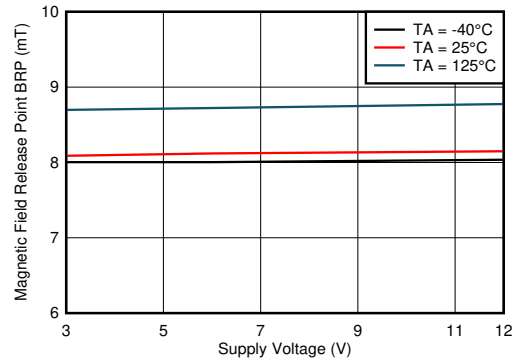

Figure 7-16. B_{RP} vs V_{CC}

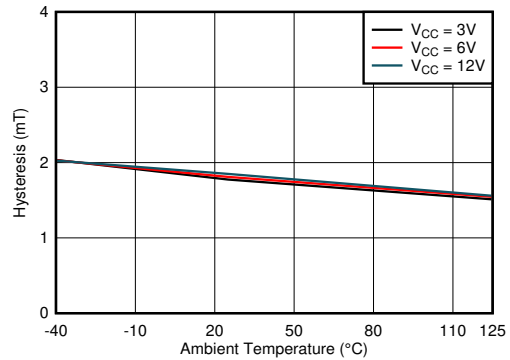

Figure 7-17. Hysteresis vs Temperature

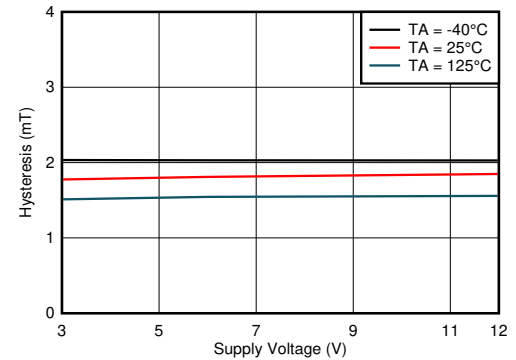

Figure 7-18. Hysteresis vs V_{CC}

7.7.4 TMAG5124D and TMAG5124H

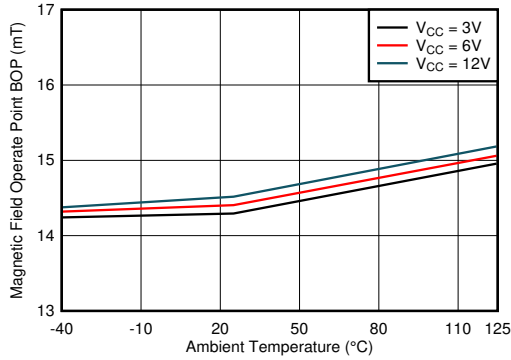

Figure 7-19. B_{OP} vs Temperature

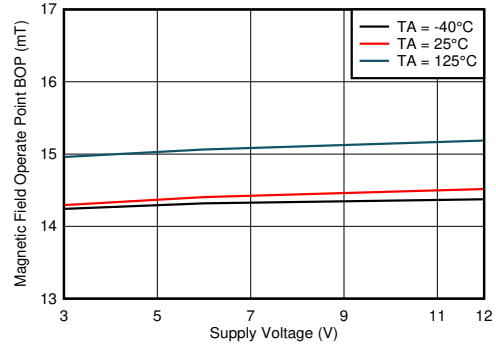

Figure 7-20. B_{OP} vs V_{CC}

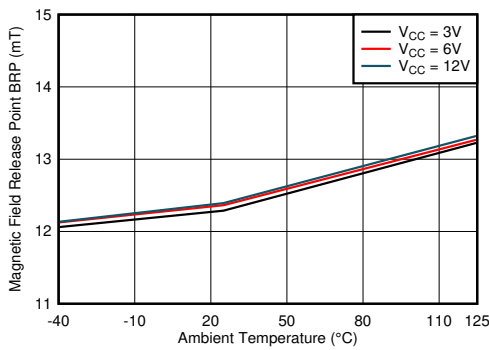

Figure 7-21. B_{RP} vs Temperature

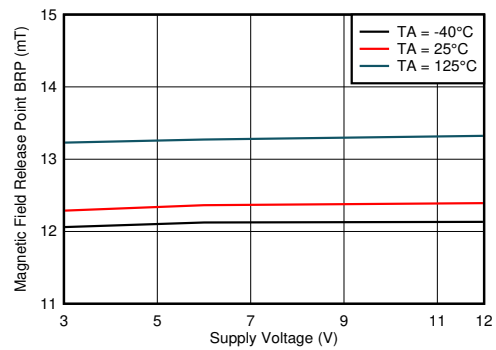

Figure 7-22. B_{RP} vs V_{CC}

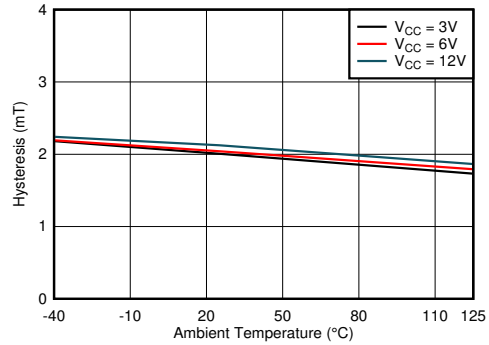

Figure 7-23. Hysteresis vs Temperature

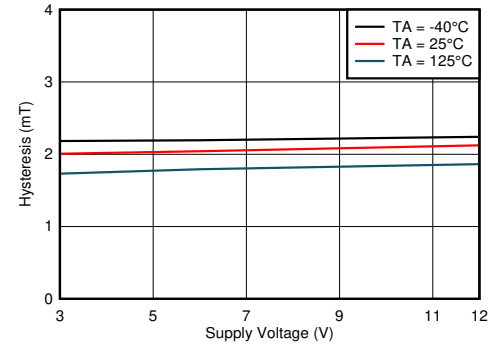
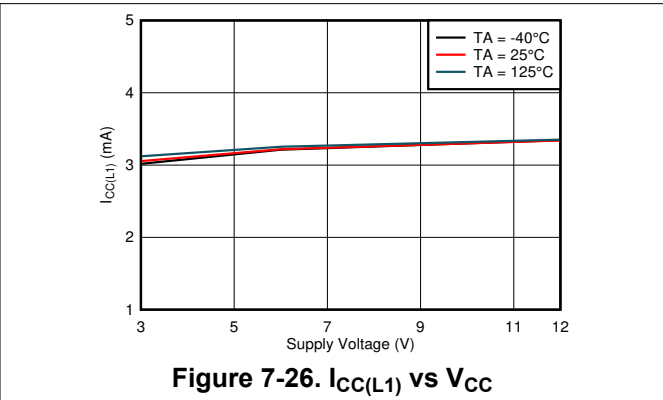
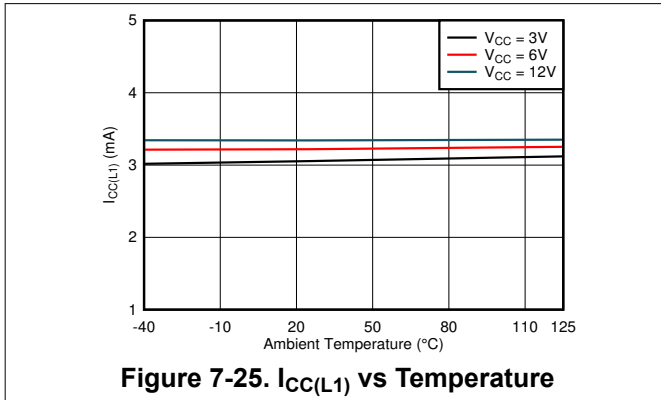

Figure 7-24. Hysteresis vs V_{CC}

7.7.5 Current Output Level

7.7.5.1 Low-Level Current Output for TMAG5124A/B/C/D



7.7.5.2 Low-Level Current Output for TMAG5124E/F/G/H

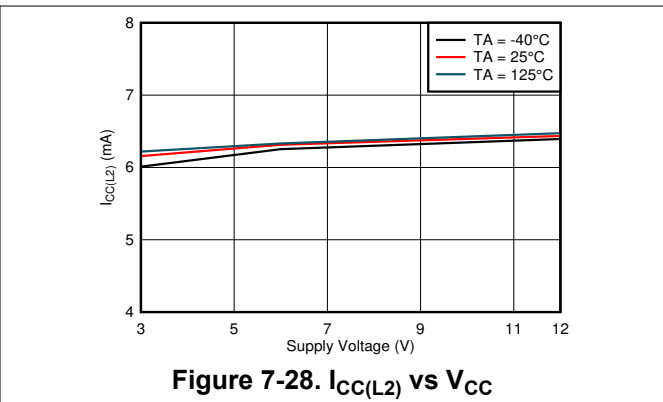
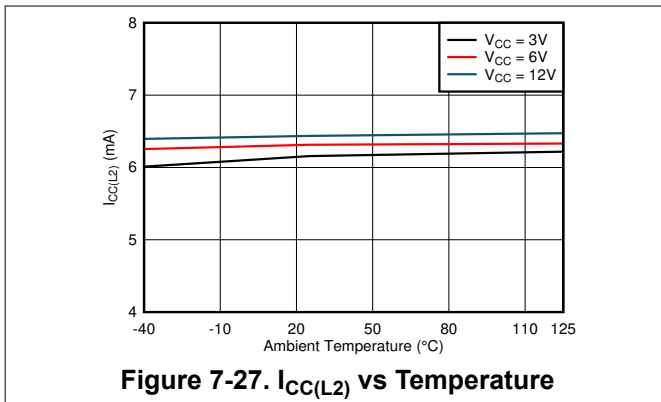

7.7.5.3 High-Level Current Output for Every Version

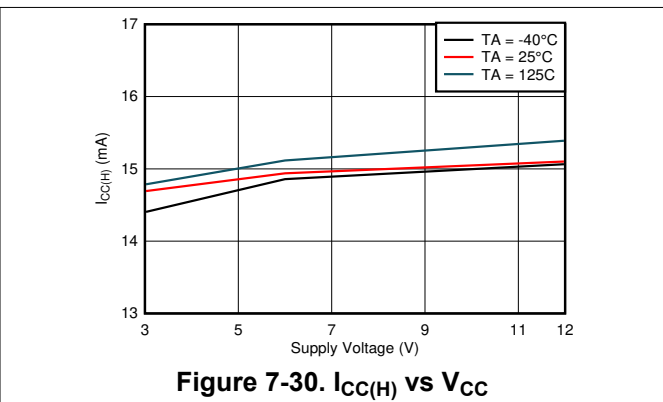
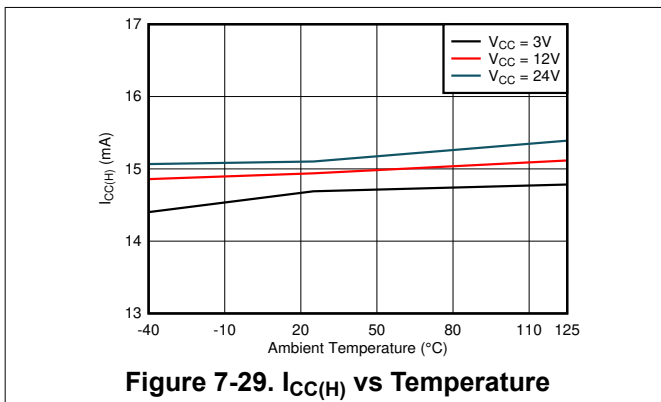

8 Detailed Description

8.1 Overview

The TMAG5124 is a magnetic sensor with a current interface, also called 2-wire interface, that indicates when the magnetic field threshold has been reached. A specific current level is generated depending on its status. All versions have a high-current level of 14.5 mA. Version A to D have a low-current level of 3.5 mA while version E to H have a low-current level of 6 mA.

The field polarity is defined as follows: a south pole near the marked side of the package has a positive magnetic field. A north pole near the marked side of the package has a negative magnetic field.

The unipolar south configuration allows the hall sensor to only respond to a south pole. A strong magnetic field of south polarity will cause the device to go into a low-current level (operate point, BOP), and a weaker magnetic field will cause the device to go into a high-current level (release point, BRP). Hysteresis is included in between the operate and release points, so magnetic field noise will not trip the device level accidentally.

Since the device does not have an output, the magnitude of device supply current will indicate if the magnetic field exceeds the threshold or not. A resistor can be placed before the VCC pin or after the GND pin to transform the current into a voltage that can be read by a microcontroller. More details are provided in [Section 9](#).

8.2 Functional Block Diagram

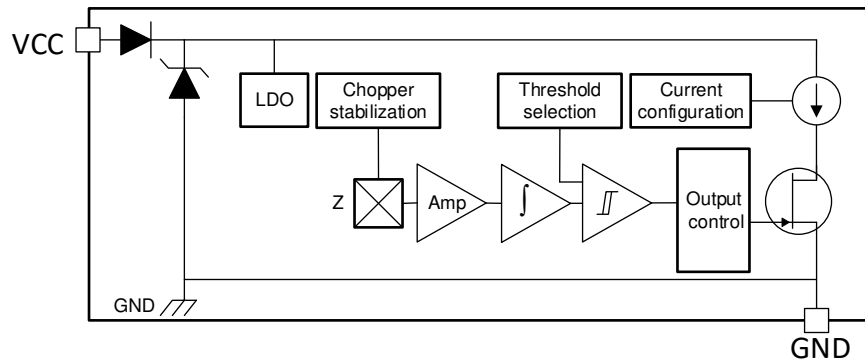

Figure 8-1. Block Diagram

8.3 Feature Description

8.3.1 Field Direction Definition

The TMAG5124 is sensitive to a south pole near the marked side of the package as shown [Figure 8-2](#).

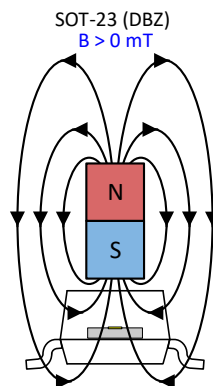

Figure 8-2. Field Direction Definition

8.3.2 Device Output

When the device is powered on and no magnetic field is applied, the output stays at $I_{CC(H)}$. If the magnetic field increases above the B_{OP} value, then the output turns to $I_{CC(L)}$. The output will remain at this value until the magnetic field decreases to a field value smaller than the B_{RP} threshold.

The $I_{CC(H)}$ for all TMAG5124x versions is between 12 mA to 17 mA. The $I_{CC(L)}$ option for the TMAG5124A/B/C/D versions is $I_{CC(L1)}$, which is typically 3.5 mA, while The $I_{CC(L)}$ for the TMAG5124E/F/G/H versions is $I_{CC(L2)}$ and is typically 6 mA.

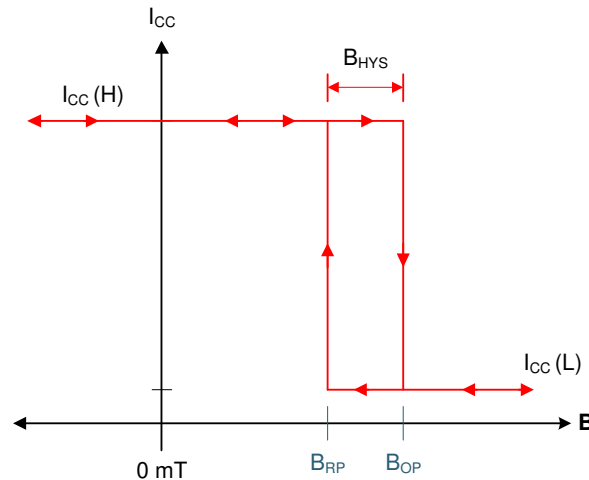

Figure 8-3. Unipolar Functionality

8.3.3 Protection Circuits

The TMAG5124 device is protected against load dump and reverse polarity conditions.

8.3.3.1 Load Dump Protection

The TMAG5124 device operates at DC V_{CC} conditions up to 38 V nominally, and can additionally withstand $V_{CC} = 40$ V. No current-limiting series resistor is required for this protection.

8.3.3.2 Reverse Polarity Protection

The TMAG5124 device is protected in the event that the VCC pin and the GND pin are reversed (up to -20 V).

8.3.4 Power-On Time

Figure 8-4 shows the behavior of the device after the V_{CC} voltage is applied and when the field is below the B_{OP} threshold. When the minimum value for V_{CC} is reached, the TMAG5124 will take time t_{ON} to power up and then time t_d to update the output to a high level.

Figure 8-5 shows the behavior of the device after the V_{CC} voltage is applied and when the field is above the B_{OP} threshold. When the minimum value for V_{CC} is reached, the TMAG5124 will take time t_{ON} to power up and then time t_d to update the output to a high level.

The output value during t_{ON} is unknown in both cases. The output value during t_d will be set at high.

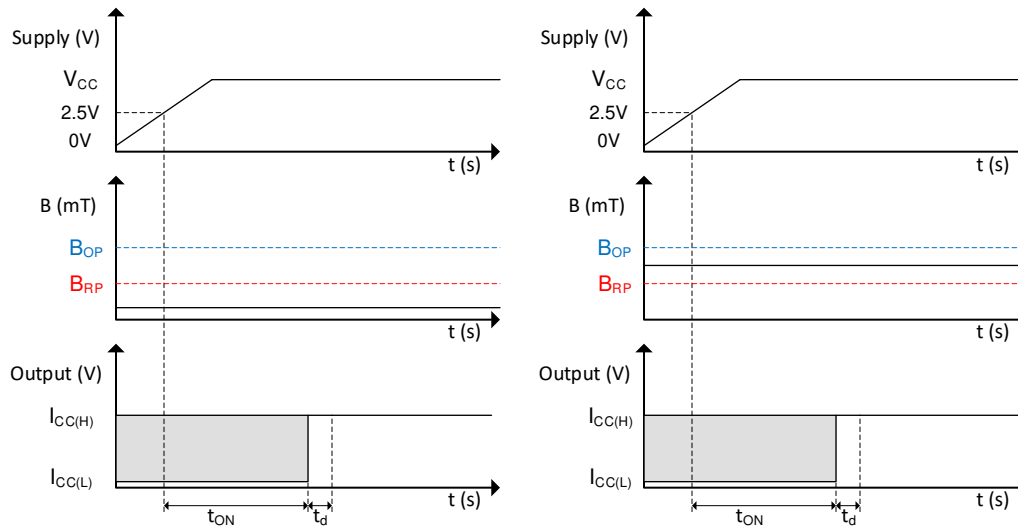

Figure 8-4. Power-On Time When $B < B_{OP}$

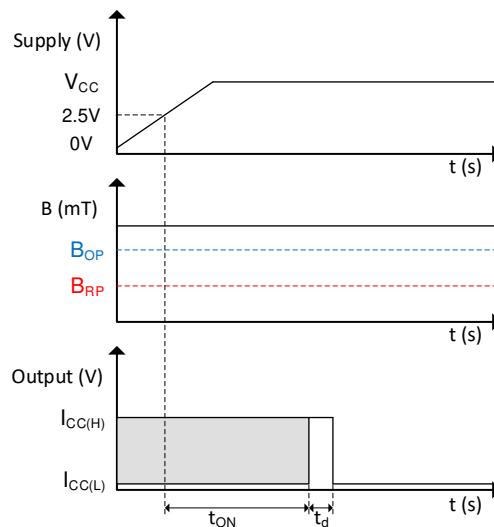

Figure 8-5. Power-On Time When $B > B_{OP}$

8.3.5 Hall Element Location

The sensing element inside the device is at the center of the package when viewed from the top. [Figure 8-6](#) shows the position of the sensor inside the package.

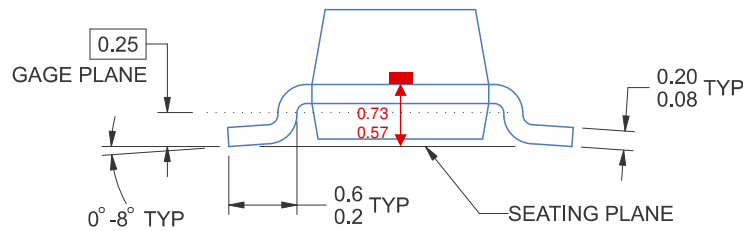
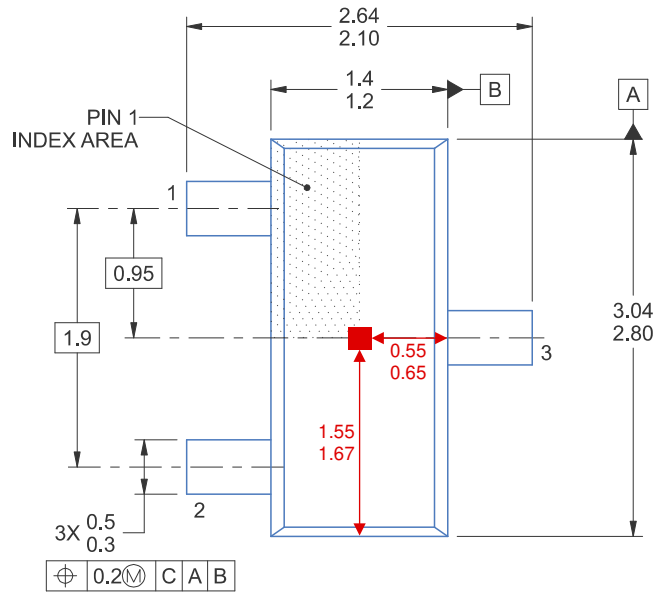

Figure 8-6. Hall Element Location

8.3.6 Propagation Delay

The TMAG5124 samples the Hall element at a nominal sampling interval of 12.5 μs to detect the presence of a magnetic south pole. Between each sampling interval, the device calculates the average magnetic field applied to the device. If this average value crosses the B_{OP} or B_{RP} threshold, the device changes the corresponding level as defined in Figure 8-3. The hall sensor + magnet system is by nature asynchronous, therefore the propagation delay (t_d) will vary depending on when the magnetic field goes above the B_{OP} value. As shown in Figure 8-7, the output delay also depends on when the magnetic field goes above the B_{OP} value.

The first graph in Figure 8-7 shows the typical case. The magnetic field goes above the B_{OP} value at the moment the output is updated. The part will only require one sampling period of 12.5 μs to update the output.

The second graph in Figure 8-7 shows a magnetic field going above the B_{OP} value just before half of the sampling period. This is the best-case scenario where the output is updated in just half of the sampling period.

Finally, the third graph in Figure 8-7 shows the worst-case scenario where the magnetic field goes above the B_{OP} value just after half of the sampling period. At the next output update, the device will still see the magnetic field under the B_{OP} threshold and will require a whole new sampling period to update the output.

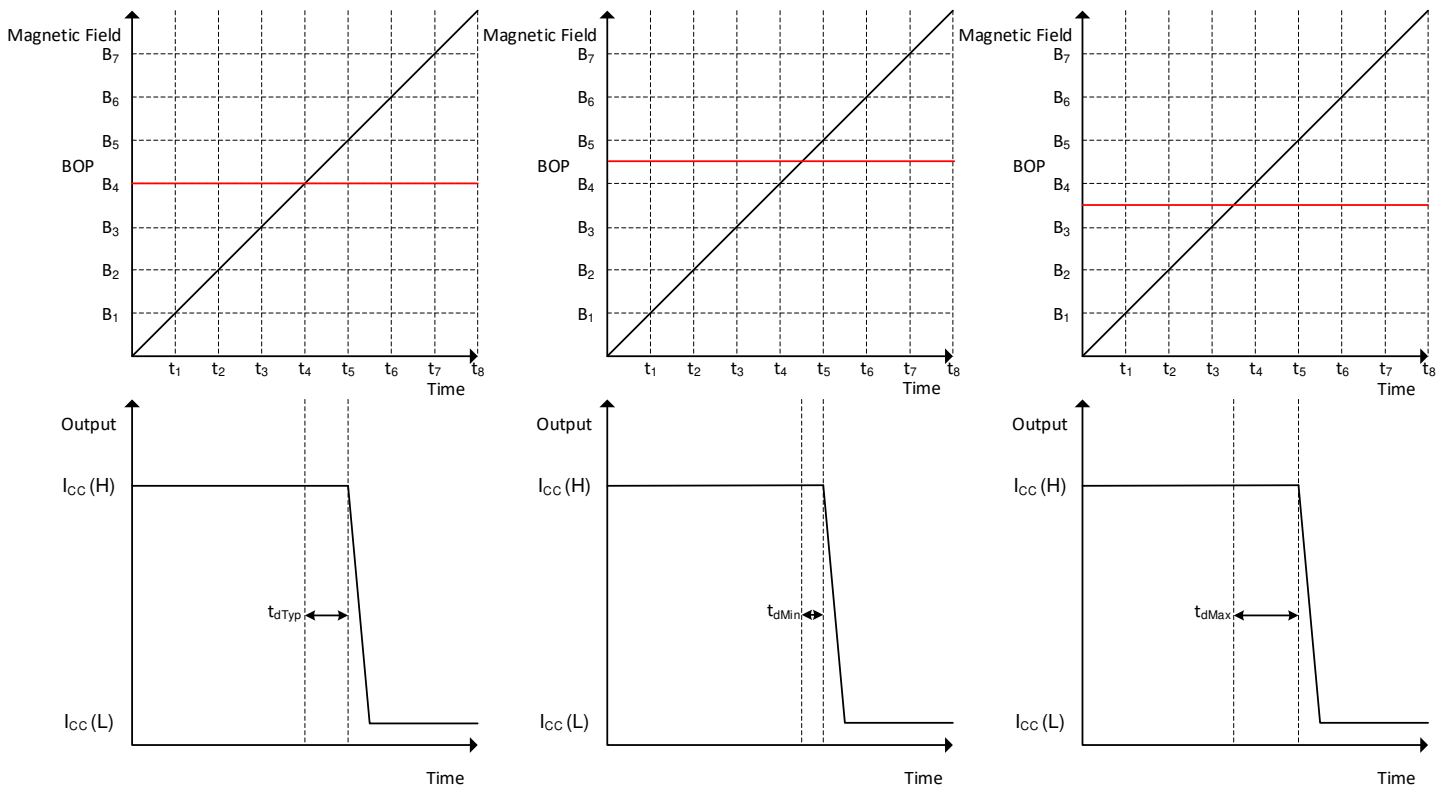

Figure 8-7. Field Sampling Timing

Figure 8-8 shows the TMAG5124 propagation delay analysis when a magnetic south pole is applied. The Hall element of the TMAG5124 experiences an increasing magnetic field as a magnetic south pole approaches the device, as well as a decreasing magnetic field as a magnetic south pole moves away. At time t_1 , the magnetic field goes above the B_{OP} threshold. The output will then start to move after the propagation delay (t_d). This time will vary depending on when the sampling period is, as shown in Figure 8-7. At t_2 , the output start pulling to the low current value. At t_3 , the output is completely pulled down to the lower current value. The same process happens on the other way when the magnetic value is going under the B_{RP} threshold.

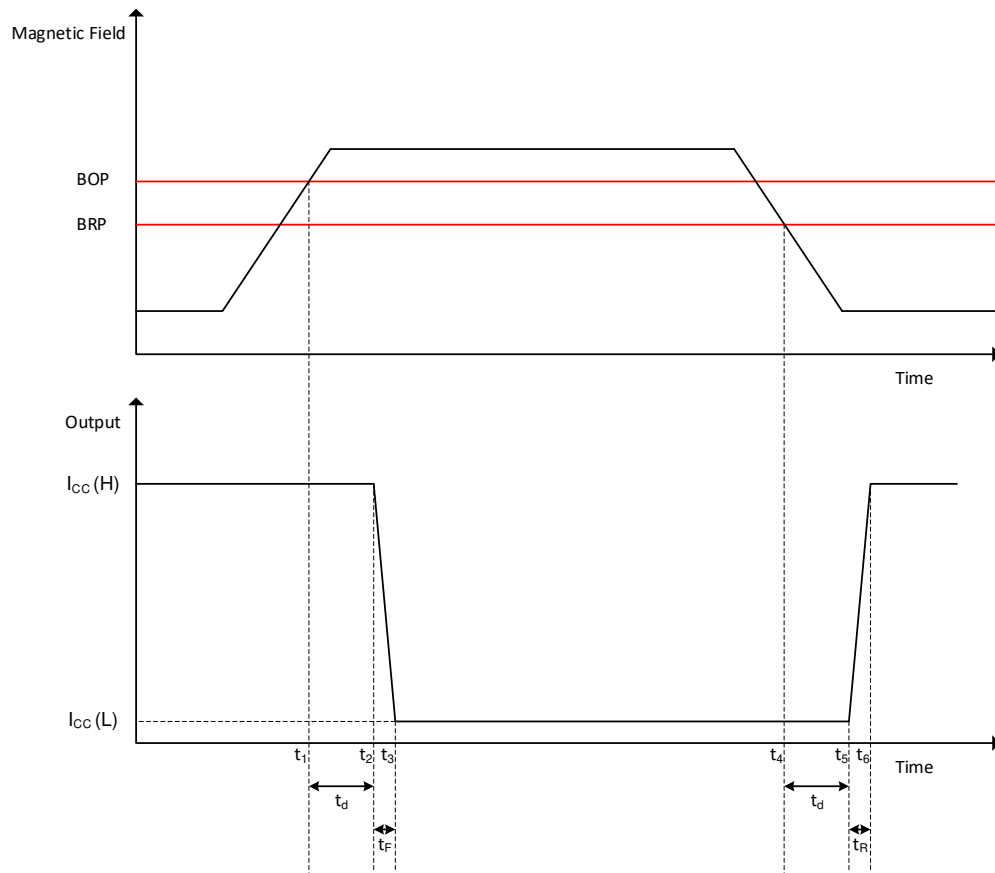

Figure 8-8. Propagation Delay

8.3.7 Chopper Stabilization

The Basic Hall-effect sensor consists of four terminals where a current is injected through two opposite terminals and a voltage is measured through the other opposite terminals. The voltage measured is proportional to the current injected and the magnetic field measured. By knowing the current injected, the device can then know the magnetic field strength. The problem is that the voltage generated is small in amplitude while the offset voltage generated is more significant. To create a precise sensor, the offset voltage must be minimized.

Chopper stabilization is one way to significantly minimize this offset. It is achieved by "spinning" the sensor and sequentially applying the bias current and measuring the voltage for each pair of terminals. This means that a measurement is completed once the spinning cycle is completed. The full cycle is completed after four measurements. The output of the sensor is connected to an amplifier and an integrator that will accumulate and filter out a voltage proportional to the magnetic field present. Finally, a comparator will switch the output if the voltage reaches either the BOP or BRP threshold (depending on which state the output voltage was previously in).

The frequency of each individual measurement is referred to as the Chopping frequency, or f_{CHOP} . The total conversion time is referred to as the Propagation delay time, t_{PD} , and is basically equal to $4/f_{\text{CHOP}}$. Finally, the Signal bandwidth, f_{BW} , represents the maximum value of the magnetic field frequency, and is equal to $(f_{\text{CHOP}}/4)/2$ as defined by the sampling theorem.

8.4 Device Functional Modes

The device operates in only one mode when operated within the *Recommended Operating Conditions*.

9 Application and Implementation

Note

Information in the following applications sections is not part of the TI component specification, and TI does not warrant its accuracy or completeness. TI's customers are responsible for determining suitability of components for their purposes. Customers should validate and test their design implementation to confirm system functionality.

9.1 Application Information

The TMAG5124 is typically used in magnetic-field sensing applications to detect the proximity of a magnet. The magnet is often attached to a movable component in the system.

The TMAG5124 is a Hall sensor that uses current as the signal of interest. Unlike voltage signals, current signals are much more robust for common problems voltages face in electrical systems, such as voltage source fluctuations and source impedance. A major factor that often leads to the choice of a current signal device is immunity to loop impedance, meaning the signal is capable of being transmitted long distances with ease. To accomplish this, the device requires a termination resistor at the end of the path for interfacing the reconstructed voltage to an input, such as a comparator. Also, diagnostic tools are easily implemented, as disconnects in the loop are easily detected due to a lack of signal.

9.2 Typical Applications

9.2.1 High-Side and Low-Side Typical Application Diagrams

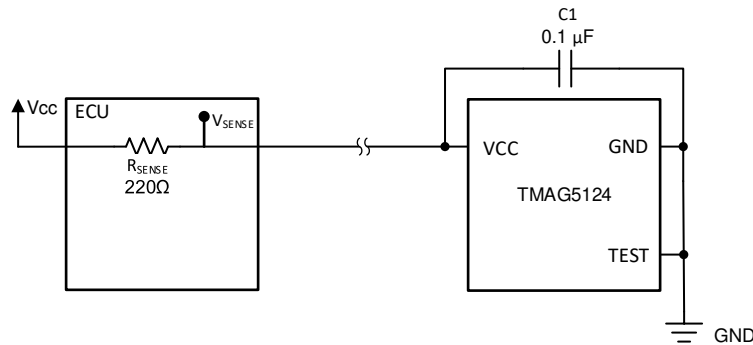

Figure 9-1. Typical High-Side Sensing Diagram

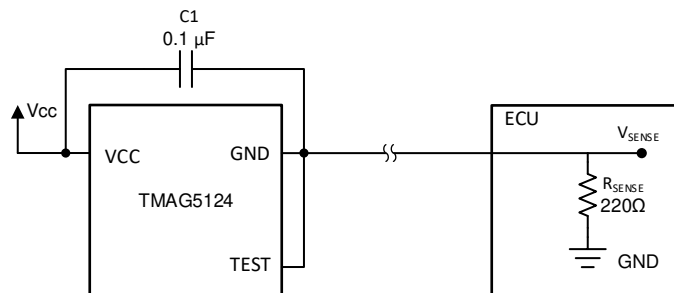

Figure 9-2. Typical Low-Side Sensing Diagram

9.2.1.1 Design Requirements

For this design example, use the parameters listed in [Table 9-1](#).

Table 9-1. Design Parameters

DESIGN PARAMETER	EXAMPLE VALUE
V_{CC}	12 V
TMAG5124 Device	TMAG5124A1
Magnet	1-cm Cube NdFeB (N45)
Minimum magnet distance	3 cm
Magnetic flux density at closest distance	5.0 mT
Magnetic flux density when magnet moves away	Close to 0 mT

9.2.1.2 Detailed Design Procedure

When designing a digital-switch magnetic sensing system, three variables should always be considered: the magnet, sensing distance, and threshold of the sensor.

The TMAG5124 device has a detection threshold specified by parameter B_{OP} , which is the amount of magnetic flux required to pass through the Hall sensor mounted inside the TMAG5124. To reliably activate the sensor, the magnet must apply a flux greater than the maximum specified B_{OP} . In such a system, the sensor typically detects the magnet before it has moved to the closest position, but designing to the maximum parameter ensures robust turn-on for all possible values of B_{OP} . When the magnet moves away from the sensor, it must apply less than the minimum specified B_{RP} to reliably release the sensor.

Magnets are made from various ferromagnetic materials that have tradeoffs in cost, drift with temperature, absolute maximum temperature ratings, remanence or residual induction (B_r), and coercivity (H_c). The B_r and the dimensions of a magnet determine the magnetic flux density (B) it produces in 3-dimensional space. For simple magnet shapes, such as rectangular blocks and cylinders, there are simple equations that solve B at a given distance centered with the magnet.

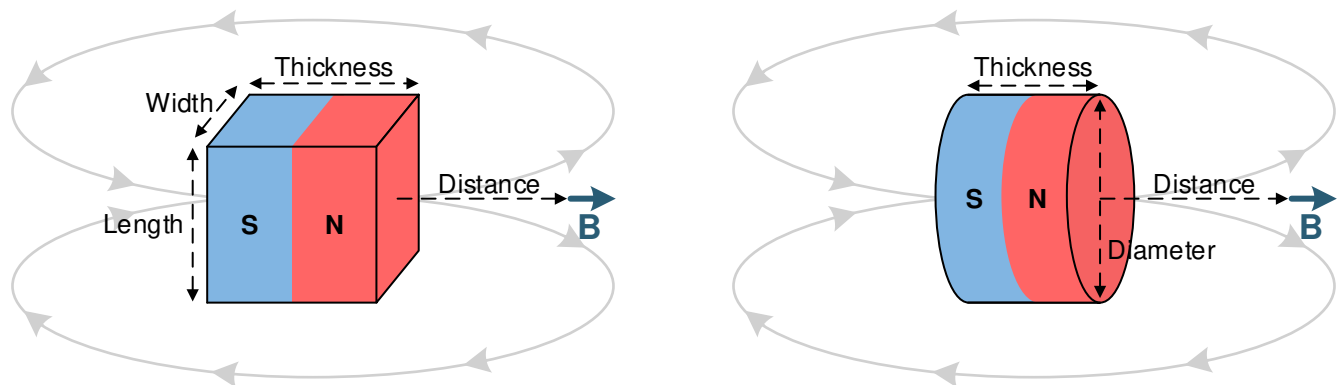

Figure 9-3. Rectangular Block and Cylinder Magnets

Use [Equation 1](#) for the rectangular block shown in [Figure 9-3](#):

$$\vec{B} = \frac{B_r}{\pi} \left(\arctan \left(\frac{WL}{2D\sqrt{4D^2 + W^2 + L^2}} \right) - \arctan \left(\frac{WL}{2(D+T)\sqrt{4(D+T)^2 + W^2 + L^2}} \right) \right) \quad (1)$$

Use Equation 2 for the cylinder shown in Figure 9-3:

$$\vec{B} = \frac{B_r}{2} \left(\frac{D+T}{\sqrt{(0.5C)^2 + (D+T)^2}} - \frac{D}{\sqrt{(0.5C)^2 + D^2}} \right) \quad (2)$$

where

- W is width.
- L is length.
- T is thickness (the direction of magnetization).
- D is distance.
- C is diameter.

The *Hall Effect Switch Magnetic Field Calculator* is an online tool that uses these formulas available here: <http://www.ti.com/product/tmag5124>.

All magnetic materials generally have a lower B_r at higher temperatures. Systems should have margin to account for this, as well as for mechanical tolerances.

For the TMAG5124A1, the maximum B_{OP} is 5 mT. When choosing a 1-cm cube NdFeB N45 magnet, Equation 1 shows that this point occurs at 3 cm. This means that the magnet will activate the sensor if the design places the magnet within 3 cm from the sensor during a "turn-on" event. If the magnet is pulled away from the device, the magnetic field will go below the minimum B_{RP} point and the device will return to its initial state.

9.2.1.3 Application Curve

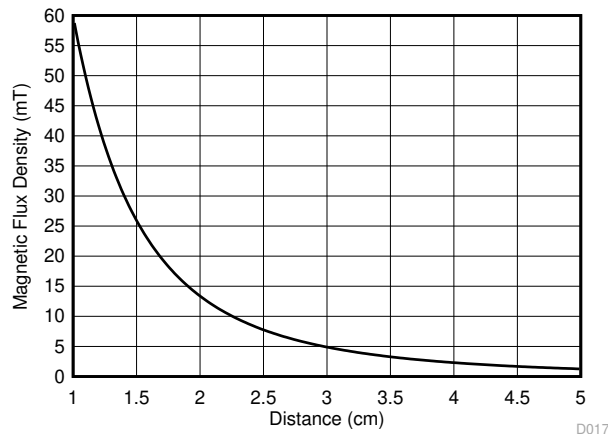

Figure 9-4. Magnetic Profile of a 1-cm Cube NdFeB Magnet

10 Power Supply Recommendations

The TMAG5124 is powered from a DC power supply of 2.5 V to 38 V. A decoupling capacitor close to the device must be used to provide local energy with minimal inductance. TI recommends using a ceramic capacitor with a value of at least 0.01 μ F.

10.1 Power Derating

The device is specified from $-40\text{ }^{\circ}\text{C}$ to $125\text{ }^{\circ}\text{C}$ for a voltage rating of 2.5 V to 38 V. The part drains at its maximum current of 17 mA, therefore the maximum voltage that can be applied to the device will depend on what maximum ambient temperature is acceptable for the application. The curve in [Figure 10-1](#) shows the maximum acceptable power supply voltage versus the maximum acceptable ambient temperature.

Use [Equation 3](#), [Equation 4](#), and [Equation 5](#) to populate the data shown in [Figure 10-1](#):

$$T_J = T_A + \Delta T \quad (3)$$

where

- T_J is the junction temperature.
- T_A is the ambient temperature.
- ΔT is the difference between the junction temperature and the ambient temperature.

$$\Delta T = P_D \times R_{\theta JA} \quad (4)$$

where

- P_D is the power dissipated by the part.
- $R_{\theta JA}$ is the junction to ambient thermal resistance.

$$P_D = V_{CC} \times I_{CC} \quad (5)$$

where

- V_{CC} is the voltage supply of the device.
- I_{CC} is the current consumption of the device.

Combining these equations gives [Equation 6](#), which can be used to determine the maximum voltage the part can handle in regards of the ambient temperature.

$$V_{CC \max} = \frac{T_{J \max} - T_A}{I_{CC \max} \times R_{\theta JA}} \quad (6)$$

For example, if an application must work under an ambient temperature maximum of $100\text{ }^{\circ}\text{C}$, and the $T_{J \max}$, $R_{\theta JA}$ and $I_{CC \max}$ are the same values defined in the data sheet, then the maximum voltage allowed for this application is calculated in [Equation 7](#):

$$V_{CC \max} = \frac{150^{\circ}\text{C} - 100^{\circ}\text{C}}{17 \text{ mA} \times 198.5^{\circ}\text{C} / \text{W}} = 14.82 \text{ V} \quad (7)$$

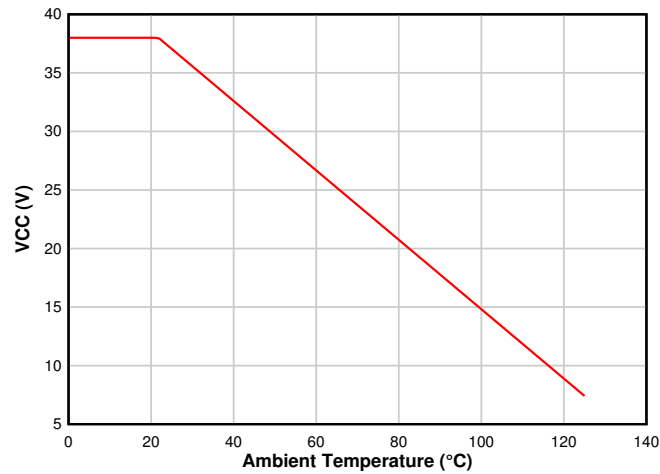

Figure 10-1. Power Derating Curve

11 Layout

11.1 Layout Guidelines

The bypass capacitor should be placed near the TMAG5124 to reduce noise. The TEST pin must be connected directly to the GND pin. It is good practice to connect the pins under the package to reduce the connection length.

Generally, using PCB copper planes underneath the TMAG5124 device has no effect on magnetic flux and does not interfere with device performance. This is because copper is not a ferromagnetic material. However, if nearby system components contain iron or nickel, they may redirect magnetic flux in unpredictable ways.

11.2 Layout Example

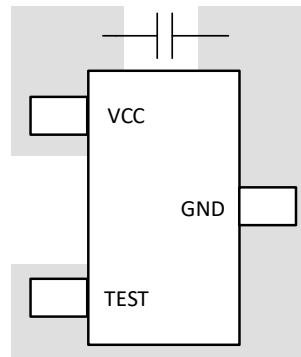

Figure 11-1. TMAG5124 Layout Example

12 Device and Documentation Support

12.1 Documentation Support

12.2 Receiving Notification of Documentation Updates

To receive notification of documentation updates, navigate to the device product folder on ti.com. Click on *Subscribe to updates* to register and receive a weekly digest of any product information that has changed. For change details, review the revision history included in any revised document.

12.3 Support Resources

[TI E2E™ support forums](#) are an engineer's go-to source for fast, verified answers and design help — straight from the experts. Search existing answers or ask your own question to get the quick design help you need.

Linked content is provided "AS IS" by the respective contributors. They do not constitute TI specifications and do not necessarily reflect TI's views; see TI's [Terms of Use](#).

12.4 Trademarks

TI E2E™ is a trademark of Texas Instruments.

All other trademarks are the property of their respective owners.

12.5 Electrostatic Discharge Caution



This integrated circuit can be damaged by ESD. Texas Instruments recommends that all integrated circuits be handled with appropriate precautions. Failure to observe proper handling and installation procedures can cause damage.

ESD damage can range from subtle performance degradation to complete device failure. Precision integrated circuits may be more susceptible to damage because very small parametric changes could cause the device not to meet its published specifications.

12.6 Glossary

[TI Glossary](#) This glossary lists and explains terms, acronyms, and definitions.

13 Mechanical, Packaging, and Orderable Information

The following pages include mechanical, packaging, and orderable information. This information is the most current data available for the designated devices. This data is subject to change without notice and revision of this document. For browser-based versions of this data sheet, refer to the left-hand navigation.

PACKAGING INFORMATION

Orderable Device	Status (1)	Package Type	Package Drawing	Pins	Package Qty	Eco Plan (2)	Lead finish/ Ball material (6)	MSL Peak Temp (3)	Op Temp (°C)	Device Marking (4/5)	Samples
TMAG5124A1CQDBZR	ACTIVE	SOT-23	DBZ	3	3000	RoHS & Green	SN	Level-3-260C-168 HR	-40 to 125	4A1	Samples
TMAG5124A1CQDBZT	ACTIVE	SOT-23	DBZ	3	250	RoHS & Green	SN	Level-3-260C-168 HR	-40 to 125	4A1	Samples
TMAG5124B1CQDBZR	ACTIVE	SOT-23	DBZ	3	3000	RoHS & Green	SN	Level-3-260C-168 HR	-40 to 125	4B1	Samples
TMAG5124B1CQDBZT	ACTIVE	SOT-23	DBZ	3	250	RoHS & Green	SN	Level-3-260C-168 HR	-40 to 125	4B1	Samples
TMAG5124C1CQDBZR	ACTIVE	SOT-23	DBZ	3	3000	RoHS & Green	SN	Level-3-260C-168 HR	-40 to 125	4C1	Samples
TMAG5124C1CQDBZT	ACTIVE	SOT-23	DBZ	3	250	RoHS & Green	SN	Level-3-260C-168 HR	-40 to 125	4C1	Samples
TMAG5124D1CQDBZR	ACTIVE	SOT-23	DBZ	3	3000	RoHS & Green	SN	Level-3-260C-168 HR	-40 to 125	4D1	Samples
TMAG5124D1CQDBZT	ACTIVE	SOT-23	DBZ	3	250	RoHS & Green	SN	Level-3-260C-168 HR	-40 to 125	4D1	Samples
TMAG5124E1CQDBZR	ACTIVE	SOT-23	DBZ	3	3000	RoHS & Green	SN	Level-3-260C-168 HR	-40 to 125	4E1	Samples
TMAG5124E1CQDBZT	ACTIVE	SOT-23	DBZ	3	250	RoHS & Green	SN	Level-3-260C-168 HR	-40 to 125	4E1	Samples
TMAG5124F1CQDBZR	ACTIVE	SOT-23	DBZ	3	3000	RoHS & Green	SN	Level-3-260C-168 HR	-40 to 125	4F1	Samples
TMAG5124F1CQDBZT	ACTIVE	SOT-23	DBZ	3	250	RoHS & Green	SN	Level-3-260C-168 HR	-40 to 125	4F1	Samples
TMAG5124G1CQDBZR	ACTIVE	SOT-23	DBZ	3	3000	RoHS & Green	SN	Level-3-260C-168 HR	-40 to 125	4G1	Samples
TMAG5124G1CQDBZT	ACTIVE	SOT-23	DBZ	3	250	RoHS & Green	SN	Level-3-260C-168 HR	-40 to 125	4G1	Samples
TMAG5124H1CQDBZR	ACTIVE	SOT-23	DBZ	3	3000	RoHS & Green	SN	Level-3-260C-168 HR	-40 to 125	4H1	Samples
TMAG5124H1CQDBZT	ACTIVE	SOT-23	DBZ	3	250	RoHS & Green	SN	Level-3-260C-168 HR	-40 to 125	4H1	Samples

(1) The marketing status values are defined as follows:

ACTIVE: Product device recommended for new designs.

LIFEBUY: TI has announced that the device will be discontinued, and a lifetime-buy period is in effect.

NRND: Not recommended for new designs. Device is in production to support existing customers, but TI does not recommend using this part in a new design.

PREVIEW: Device has been announced but is not in production. Samples may or may not be available.

OBSELETE: TI has discontinued the production of the device.

(2) **RoHS:** TI defines "RoHS" to mean semiconductor products that are compliant with the current EU RoHS requirements for all 10 RoHS substances, including the requirement that RoHS substance do not exceed 0.1% by weight in homogeneous materials. Where designed to be soldered at high temperatures, "RoHS" products are suitable for use in specified lead-free processes. TI may reference these types of products as "Pb-Free".

RoHS Exempt: TI defines "RoHS Exempt" to mean products that contain lead but are compliant with EU RoHS pursuant to a specific EU RoHS exemption.

Green: TI defines "Green" to mean the content of Chlorine (Cl) and Bromine (Br) based flame retardants meet JS709B low halogen requirements of ≤ 1000 ppm threshold. Antimony trioxide based flame retardants must also meet the ≤ 1000 ppm threshold requirement.

(3) MSL, Peak Temp. - The Moisture Sensitivity Level rating according to the JEDEC industry standard classifications, and peak solder temperature.

(4) There may be additional marking, which relates to the logo, the lot trace code information, or the environmental category on the device.

(5) Multiple Device Markings will be inside parentheses. Only one Device Marking contained in parentheses and separated by a "~" will appear on a device. If a line is indented then it is a continuation of the previous line and the two combined represent the entire Device Marking for that device.

(6) Lead finish/Ball material - Orderable Devices may have multiple material finish options. Finish options are separated by a vertical ruled line. Lead finish/Ball material values may wrap to two lines if the finish value exceeds the maximum column width.

Important Information and Disclaimer: The information provided on this page represents TI's knowledge and belief as of the date that it is provided. TI bases its knowledge and belief on information provided by third parties, and makes no representation or warranty as to the accuracy of such information. Efforts are underway to better integrate information from third parties. TI has taken and continues to take reasonable steps to provide representative and accurate information but may not have conducted destructive testing or chemical analysis on incoming materials and chemicals. TI and TI suppliers consider certain information to be proprietary, and thus CAS numbers and other limited information may not be available for release.

In no event shall TI's liability arising out of such information exceed the total purchase price of the TI part(s) at issue in this document sold by TI to Customer on an annual basis.

TAPE AND REEL INFORMATION



QUADRANT ASSIGNMENTS FOR PIN 1 ORIENTATION IN TAPE



*All dimensions are nominal

Device	Package Type	Package Drawing	Pins	SPQ	Reel Diameter (mm)	Reel Width W1 (mm)	A0 (mm)	B0 (mm)	K0 (mm)	P1 (mm)	W (mm)	Pin1 Quadrant
TMAG5124A1CQDBZR	SOT-23	DBZ	3	3000	178.0	9.0	3.15	2.77	1.22	4.0	8.0	Q3
TMAG5124A1CQDBZT	SOT-23	DBZ	3	250	178.0	9.0	3.15	2.77	1.22	4.0	8.0	Q3
TMAG5124B1CQDBZR	SOT-23	DBZ	3	3000	178.0	9.0	3.15	2.77	1.22	4.0	8.0	Q3
TMAG5124B1CQDBZT	SOT-23	DBZ	3	250	178.0	9.0	3.15	2.77	1.22	4.0	8.0	Q3
TMAG5124C1CQDBZR	SOT-23	DBZ	3	3000	178.0	9.0	3.15	2.77	1.22	4.0	8.0	Q3
TMAG5124C1CQDBZT	SOT-23	DBZ	3	250	178.0	9.0	3.15	2.77	1.22	4.0	8.0	Q3
TMAG5124D1CQDBZR	SOT-23	DBZ	3	3000	178.0	9.0	3.15	2.77	1.22	4.0	8.0	Q3
TMAG5124D1CQDBZT	SOT-23	DBZ	3	250	178.0	9.0	3.15	2.77	1.22	4.0	8.0	Q3
TMAG5124E1CQDBZR	SOT-23	DBZ	3	3000	178.0	9.0	3.15	2.77	1.22	4.0	8.0	Q3
TMAG5124E1CQDBZT	SOT-23	DBZ	3	250	178.0	9.0	3.15	2.77	1.22	4.0	8.0	Q3
TMAG5124F1CQDBZR	SOT-23	DBZ	3	3000	178.0	9.0	3.15	2.77	1.22	4.0	8.0	Q3
TMAG5124F1CQDBZT	SOT-23	DBZ	3	250	178.0	9.0	3.15	2.77	1.22	4.0	8.0	Q3
TMAG5124G1CQDBZR	SOT-23	DBZ	3	3000	178.0	9.0	3.15	2.77	1.22	4.0	8.0	Q3
TMAG5124G1CQDBZT	SOT-23	DBZ	3	250	178.0	9.0	3.15	2.77	1.22	4.0	8.0	Q3
TMAG5124H1CQDBZR	SOT-23	DBZ	3	3000	178.0	9.0	3.15	2.77	1.22	4.0	8.0	Q3
TMAG5124H1CQDBZT	SOT-23	DBZ	3	250	178.0	9.0	3.15	2.77	1.22	4.0	8.0	Q3

TAPE AND REEL BOX DIMENSIONS

*All dimensions are nominal

Device	Package Type	Package Drawing	Pins	SPQ	Length (mm)	Width (mm)	Height (mm)
TMAG5124A1CQDBZR	SOT-23	DBZ	3	3000	180.0	180.0	18.0
TMAG5124A1CQDBZT	SOT-23	DBZ	3	250	180.0	180.0	18.0
TMAG5124B1CQDBZR	SOT-23	DBZ	3	3000	180.0	180.0	18.0
TMAG5124B1CQDBZT	SOT-23	DBZ	3	250	180.0	180.0	18.0
TMAG5124C1CQDBZR	SOT-23	DBZ	3	3000	180.0	180.0	18.0
TMAG5124C1CQDBZT	SOT-23	DBZ	3	250	180.0	180.0	18.0
TMAG5124D1CQDBZR	SOT-23	DBZ	3	3000	180.0	180.0	18.0
TMAG5124D1CQDBZT	SOT-23	DBZ	3	250	180.0	180.0	18.0
TMAG5124E1CQDBZR	SOT-23	DBZ	3	3000	180.0	180.0	18.0
TMAG5124E1CQDBZT	SOT-23	DBZ	3	250	180.0	180.0	18.0
TMAG5124F1CQDBZR	SOT-23	DBZ	3	3000	180.0	180.0	18.0
TMAG5124F1CQDBZT	SOT-23	DBZ	3	250	180.0	180.0	18.0
TMAG5124G1CQDBZR	SOT-23	DBZ	3	3000	180.0	180.0	18.0
TMAG5124G1CQDBZT	SOT-23	DBZ	3	250	180.0	180.0	18.0
TMAG5124H1CQDBZR	SOT-23	DBZ	3	3000	180.0	180.0	18.0
TMAG5124H1CQDBZT	SOT-23	DBZ	3	250	180.0	180.0	18.0

DBZ0003A



PACKAGE OUTLINE

SOT-23 - 1.12 mm max height

SMALL OUTLINE TRANSISTOR

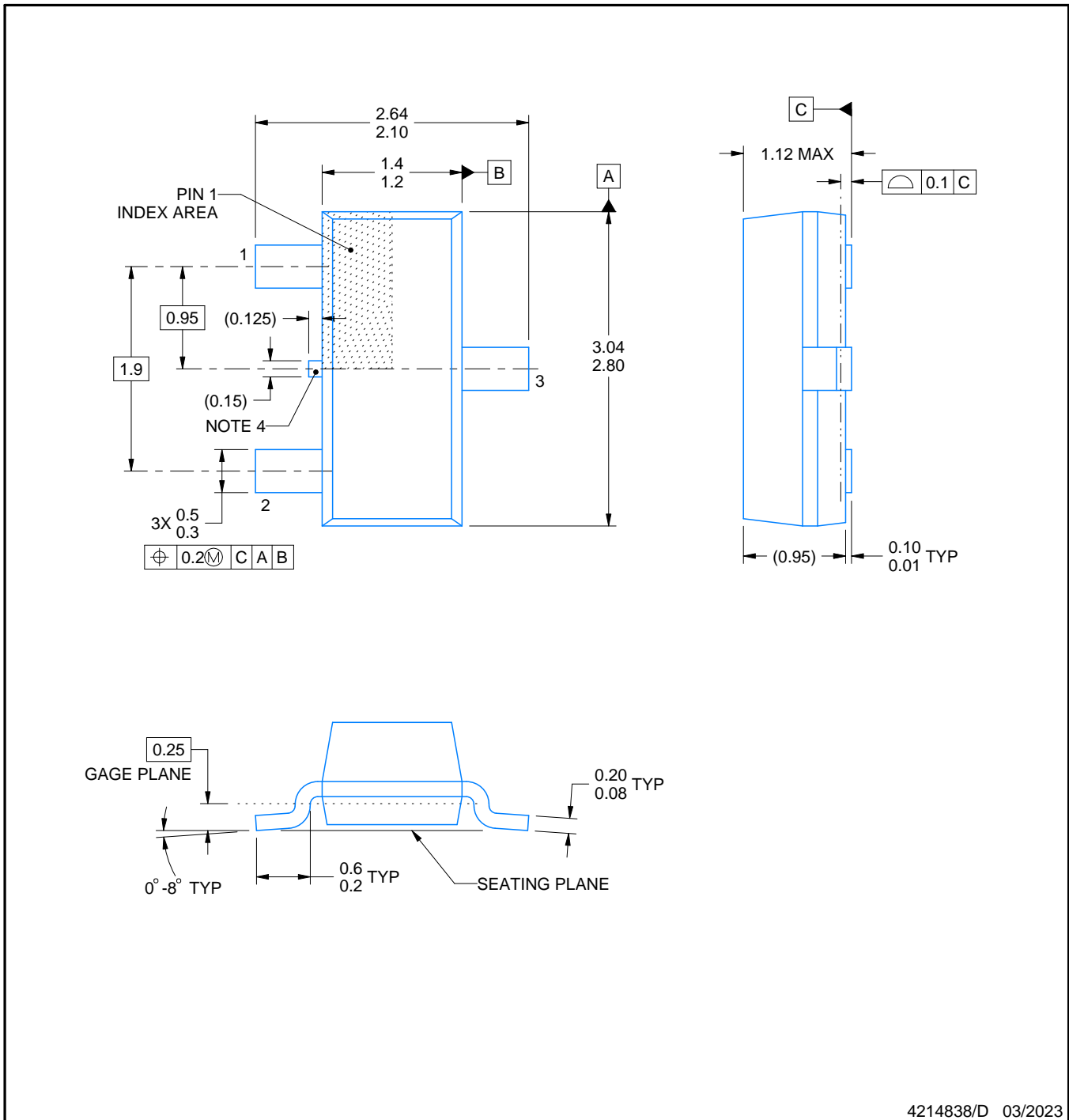

4214838/D 03/2023

NOTES:

1. All linear dimensions are in millimeters. Any dimensions in parenthesis are for reference only. Dimensioning and tolerancing per ASME Y14.5M.
2. This drawing is subject to change without notice.
3. Reference JEDEC registration TO-236, except minimum foot length.
4. Support pin may differ or may not be present.

EXAMPLE BOARD LAYOUT

DBZ0003A

SOT-23 - 1.12 mm max height

SMALL OUTLINE TRANSISTOR

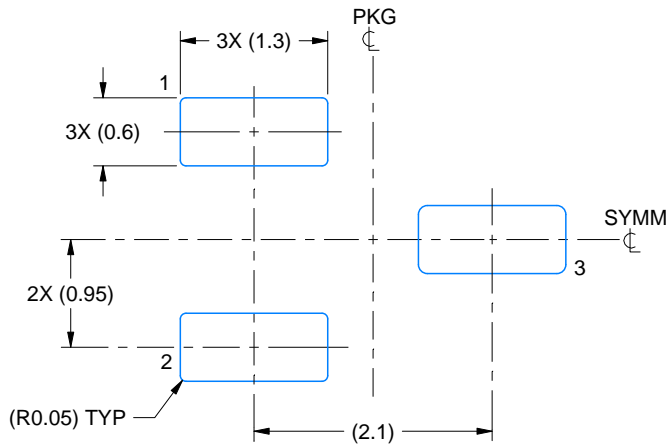

LAND PATTERN EXAMPLE
SCALE:15X

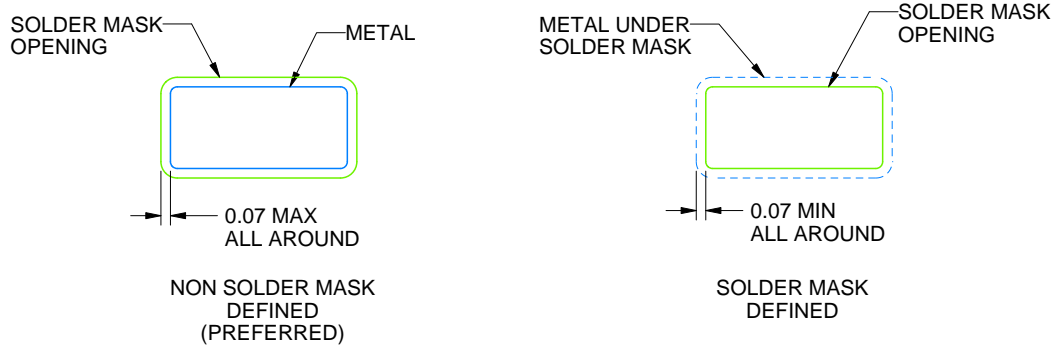

SOLDER MASK DETAILS

4214838/D 03/2023

NOTES: (continued)

4. Publication IPC-7351 may have alternate designs.
5. Solder mask tolerances between and around signal pads can vary based on board fabrication site.

EXAMPLE STENCIL DESIGN

DBZ0003A

SOT-23 - 1.12 mm max height

SMALL OUTLINE TRANSISTOR

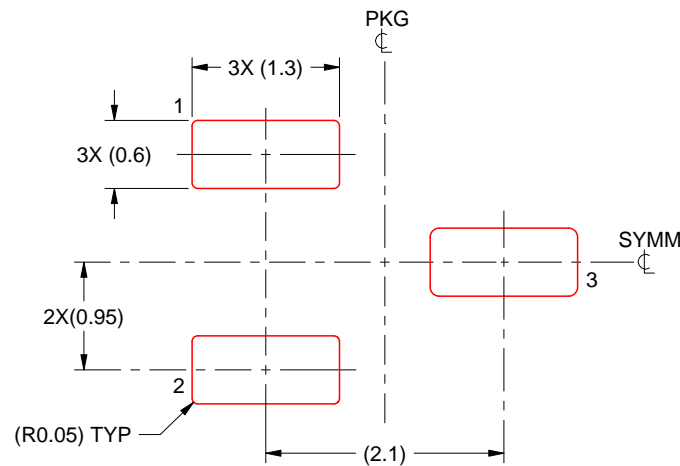

SOLDER PASTE EXAMPLE
BASED ON 0.125 THICK STENCIL
SCALE:15X

4214838/D 03/2023

NOTES: (continued)

6. Laser cutting apertures with trapezoidal walls and rounded corners may offer better paste release. IPC-7525 may have alternate design recommendations.
7. Board assembly site may have different recommendations for stencil design.

IMPORTANT NOTICE AND DISCLAIMER

TI PROVIDES TECHNICAL AND RELIABILITY DATA (INCLUDING DATA SHEETS), DESIGN RESOURCES (INCLUDING REFERENCE DESIGNS), APPLICATION OR OTHER DESIGN ADVICE, WEB TOOLS, SAFETY INFORMATION, AND OTHER RESOURCES "AS IS" AND WITH ALL FAULTS, AND DISCLAIMS ALL WARRANTIES, EXPRESS AND IMPLIED, INCLUDING WITHOUT LIMITATION ANY IMPLIED WARRANTIES OF MERCHANTABILITY, FITNESS FOR A PARTICULAR PURPOSE OR NON-INFRINGEMENT OF THIRD PARTY INTELLECTUAL PROPERTY RIGHTS.

These resources are intended for skilled developers designing with TI products. You are solely responsible for (1) selecting the appropriate TI products for your application, (2) designing, validating and testing your application, and (3) ensuring your application meets applicable standards, and any other safety, security, regulatory or other requirements.

These resources are subject to change without notice. TI grants you permission to use these resources only for development of an application that uses the TI products described in the resource. Other reproduction and display of these resources is prohibited. No license is granted to any other TI intellectual property right or to any third party intellectual property right. TI disclaims responsibility for, and you will fully indemnify TI and its representatives against, any claims, damages, costs, losses, and liabilities arising out of your use of these resources.

TI's products are provided subject to [TI's Terms of Sale](#) or other applicable terms available either on [ti.com](https://www.ti.com) or provided in conjunction with such TI products. TI's provision of these resources does not expand or otherwise alter TI's applicable warranties or warranty disclaimers for TI products.

TI objects to and rejects any additional or different terms you may have proposed.

Mailing Address: Texas Instruments, Post Office Box 655303, Dallas, Texas 75265
Copyright © 2023, Texas Instruments Incorporated