

# High Intensity LED, Ø 5 mm Untinted Non-Diffused Package

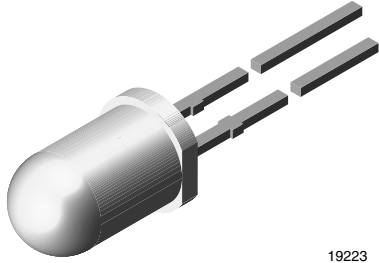

19223

## DESCRIPTION

This device has been designed to meet the increasing demand for extremely bright red LEDs.

It is housed in a 5 mm untinted non-diffused plastic package. The very small viewing angle of this device provides a very high luminous intensity.

## PRODUCT GROUP AND PACKAGE DATA

- Product group: LED
- Package: 5 mm
- Product series: standard
- Angle of half intensity:  $\pm 4^\circ$

## FEATURES

- AllnGaP technology
- Standard T-1 $\frac{3}{4}$  package
- Small mechanical tolerances
- Suitable for DC and high peak current
- Very small viewing angle
- Very high intensity
- Luminous intensity categorized
- ESD-withstand voltage up to 2 kV according to JESD22-A114-B
- Material categorization: For definitions of compliance please see [www.vishay.com/doc?99912](http://www.vishay.com/doc?99912)



**RoHS**  
COMPLIANT  
HALOGEN  
**FREE**  
**GREEN**  
(5-2008)

## APPLICATIONS

- Status lights
- Off/on indicators
- Lightpipes
- Outdoor displays
- Medical instruments
- Maintenance lights
- Legend lights

## PARTS TABLE

PART	COLOR	LUMINOUS INTENSITY (mcd)			at I <sub>F</sub> (mA)	WAVELENGTH (nm)			at I <sub>F</sub> (mA)	FORWARD VOLTAGE (V)			at I <sub>F</sub> (mA)	TECHNOLOGY
		MIN.	TYP.	MAX.		MIN.	TYP.	MAX.		MIN.	TYP.	MAX.		
TLHK5800	Red	1000	5500	-	20	-	630	-	10	-	1.9	2.6	20	AllnGaP on GaAs

## ABSOLUTE MAXIMUM RATINGS (T<sub>amb</sub> = 25 °C, unless otherwise specified) TLHK5800

PARAMETER	TEST CONDITION	SYMBOL	VALUE	UNIT
Reverse voltage		V <sub>R</sub>	5	V
DC forward current	T <sub>amb</sub> ≤ 65 °C	I <sub>F</sub>	30	mA
Surge forward current	t <sub>p</sub> ≤ 10 μs	I <sub>FSM</sub>	0.1	A
Power dissipation	T <sub>amb</sub> ≤ 65 °C	P <sub>V</sub>	80	mW
Junction temperature		T <sub>j</sub>	100	°C
Operating temperature range		T <sub>amb</sub>	- 40 to + 100	°C
Storage temperature range		T <sub>stg</sub>	- 55 to + 100	°C
Soldering temperature	t ≤ 5 s, 2 mm from body	T <sub>sd</sub>	260	°C
Thermal resistance junction/ambient		R <sub>thJA</sub>	350	K/W



<b>OPTICAL AND ELECTRICAL CHARACTERISTICS</b> ( $T_{amb} = 25\text{ }^{\circ}\text{C}$ , unless otherwise specified)						
<b>TLHK5800, RED</b>						
PARAMETER	TEST CONDITION	SYMBOL	MIN.	TYP.	MAX.	UNIT
Luminous intensity <sup>(1)</sup>	$I_F = 20\text{ mA}$	$I_V$	1000	5500	-	mcd
Dominant wavelength	$I_F = 10\text{ mA}$	$\lambda_d$	-	630	-	nm
Peak wavelength	$I_F = 10\text{ mA}$	$\lambda_p$	-	643	-	nm
Angle of half intensity	$I_F = 10\text{ mA}$	$\varphi$	-	$\pm 4$	-	deg
Forward voltage	$I_F = 20\text{ mA}$	$V_F$	-	1.9	2.6	V
Reverse voltage	$I_R = 10\text{ }\mu\text{A}$	$V_R$	5	-	-	V
Junction capacitance	$V_R = 0\text{ V}$ , $f = 1\text{ MHz}$	$C_j$	-	15	-	pF

**Note**

<sup>(1)</sup> In one packing unit  $I_{Vmin}/I_{Vmax} \leq 0.5$

<b>LUMINOUS INTENSITY CLASSIFICATION</b>		
GROUP	LUMINOUS INTENSITY (mcd)	
	MIN.	MAX.
BB	430	860
CC	575	1150
DD	750	1500
EE	1000	2000
FF	1350	2700
GG	1800	3600
HH	2400	4800
II	3200	6400
KK	4300	8600
LL	5750	11 500
MM	7500	15 000
NN	10 000	20 000
PP	13 500	27 000
QQ	18 000	36 000
RR	24 000	48 000
SS	32 000	64 000
TT	43 000	86 000
UU	57 500	115 000

**Note**

- Luminous intensity is tested at a current pulse duration of 25 ms and an accuracy of  $\pm 11\%$ .  
 The above type numbers represent the order groups which include only a few brightness groups. Only one group will be shipped on each bag (there will be no mixing of two groups on each bag).  
 In order to ensure availability, single brightness groups will not be orderable.  
 In a similar manner for colors where wavelength groups are measured and binned, single wavelength groups will be shipped in any one bag.  
 In order to ensure availability, single wavelength groups will not be orderable.

**TYPICAL CHARACTERISTICS** ( $T_{amb} = 25\text{ }^{\circ}\text{C}$ , unless otherwise specified)

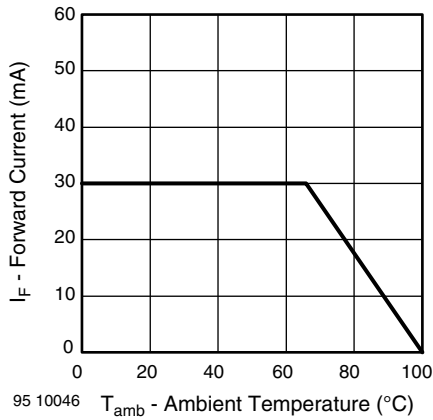

Fig. 1 - Forward Current vs. Ambient Temperature



Fig. 4 - Relative Luminous Intensity vs. Ambient Temperature

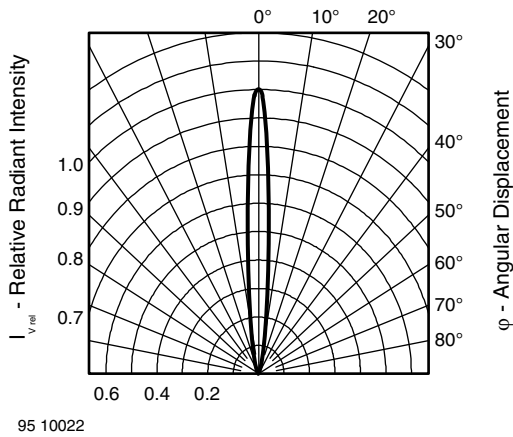

Fig. 2 - Relative Luminous Intensity vs. Angular Displacement

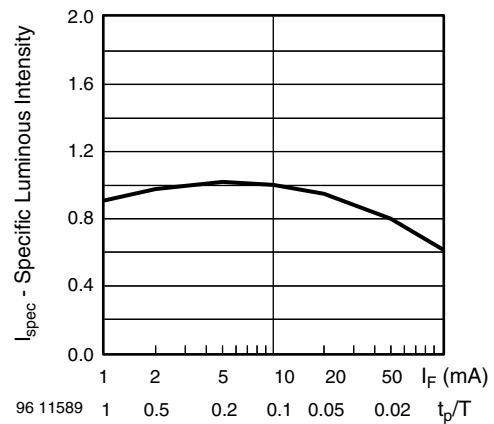

Fig. 5 - Relative Luminous Intensity vs. Forward Current/Duty Cycle

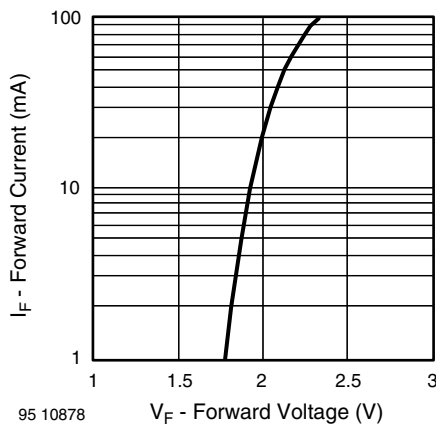

Fig. 3 - Forward Current vs. Forward Voltage

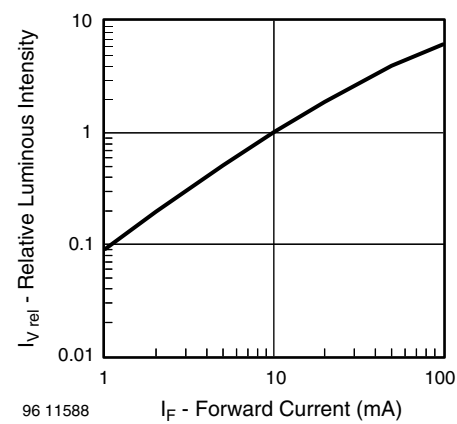

Fig. 6 - Relative Luminous Intensity vs. Forward Current

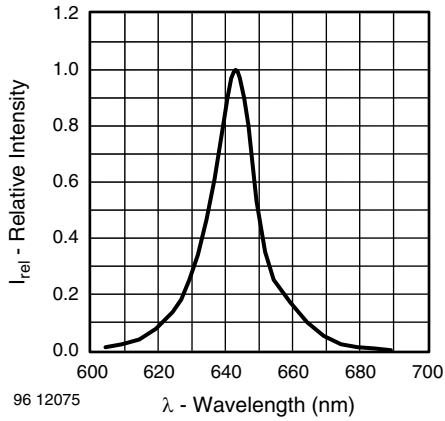
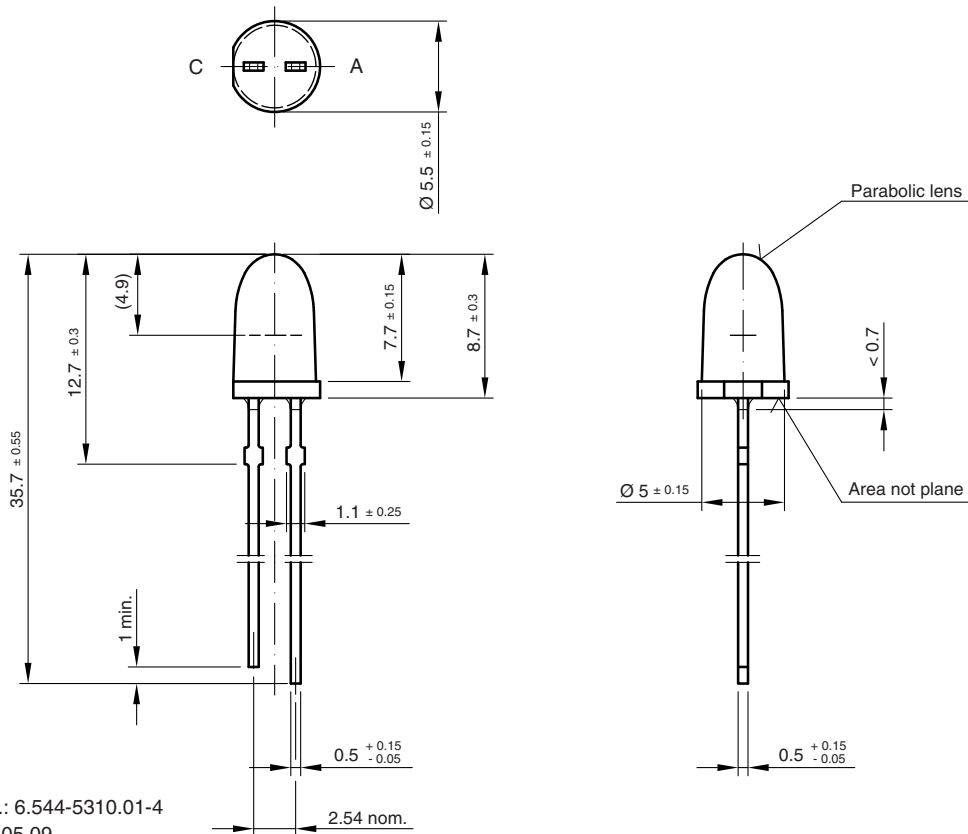

Fig. 7 - Relative Intensity vs. Wavelength

**PACKAGE DIMENSIONS** in millimeters



Drawing-No.: 6.544-5310.01-4  
 Issue: 4; 19.05.09  
 95 11476

technical drawings  
 according to DIN  
 specifications



## Disclaimer

ALL PRODUCT, PRODUCT SPECIFICATIONS AND DATA ARE SUBJECT TO CHANGE WITHOUT NOTICE TO IMPROVE RELIABILITY, FUNCTION OR DESIGN OR OTHERWISE.

Vishay Intertechnology, Inc., its affiliates, agents, and employees, and all persons acting on its or their behalf (collectively, "Vishay"), disclaim any and all liability for any errors, inaccuracies or incompleteness contained in any datasheet or in any other disclosure relating to any product.

Vishay makes no warranty, representation or guarantee regarding the suitability of the products for any particular purpose or the continuing production of any product. To the maximum extent permitted by applicable law, Vishay disclaims (i) any and all liability arising out of the application or use of any product, (ii) any and all liability, including without limitation special, consequential or incidental damages, and (iii) any and all implied warranties, including warranties of fitness for particular purpose, non-infringement and merchantability.

Statements regarding the suitability of products for certain types of applications are based on Vishay's knowledge of typical requirements that are often placed on Vishay products in generic applications. Such statements are not binding statements about the suitability of products for a particular application. It is the customer's responsibility to validate that a particular product with the properties described in the product specification is suitable for use in a particular application. Parameters provided in datasheets and / or specifications may vary in different applications and performance may vary over time. All operating parameters, including typical parameters, must be validated for each customer application by the customer's technical experts. Product specifications do not expand or otherwise modify Vishay's terms and conditions of purchase, including but not limited to the warranty expressed therein.

Hyperlinks included in this datasheet may direct users to third-party websites. These links are provided as a convenience and for informational purposes only. Inclusion of these hyperlinks does not constitute an endorsement or an approval by Vishay of any of the products, services or opinions of the corporation, organization or individual associated with the third-party website. Vishay disclaims any and all liability and bears no responsibility for the accuracy, legality or content of the third-party website or for that of subsequent links.

Except as expressly indicated in writing, Vishay products are not designed for use in medical, life-saving, or life-sustaining applications or for any other application in which the failure of the Vishay product could result in personal injury or death. Customers using or selling Vishay products not expressly indicated for use in such applications do so at their own risk. Please contact authorized Vishay personnel to obtain written terms and conditions regarding products designed for such applications.

No license, express or implied, by estoppel or otherwise, to any intellectual property rights is granted by this document or by any conduct of Vishay. Product names and markings noted herein may be trademarks of their respective owners.