

Order Code	TCK-069
Inductance	33 μ H \pm 20% (at 1 kHz / 250 mV)
Impedance (DCR)	130 m Ω max.
Rated Current	1.2 A max.
Operating Temperature	-40°C to +125°C
RoHS Exemptions	No Exemptions

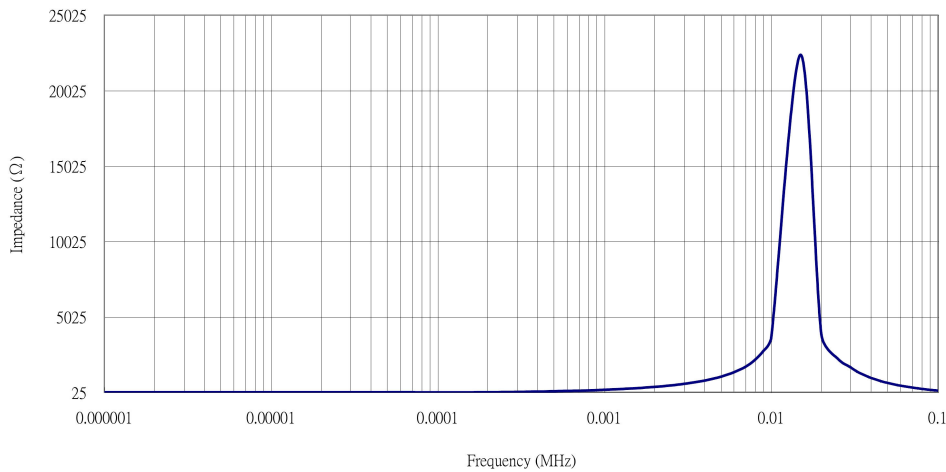

Impedance Curve



Outline Dimensions

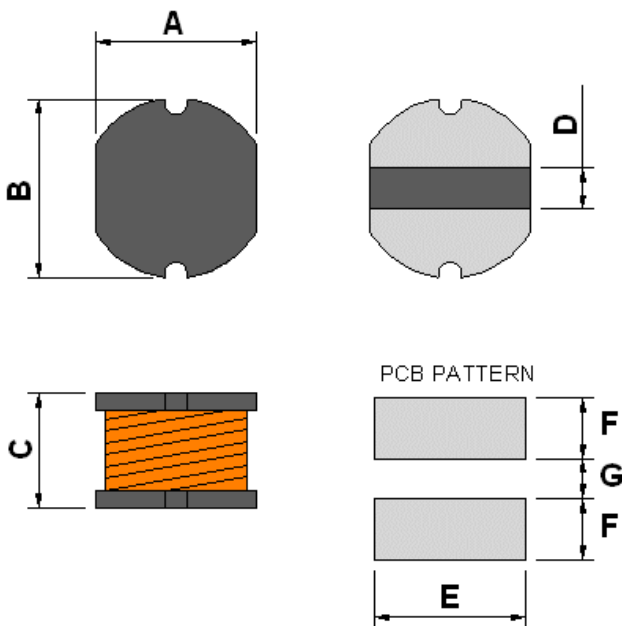

Dimensions [mm]	
A	7.0 \pm 0.5
B	7.8 \pm 0.5
C	5.0 \pm 0.7
D	2.1 typ.
E	7.5
F	3
G	2

All specifications valid at +25°C, unless otherwise stated.