

**SERIES:** SWI5-N-USB | **DESCRIPTION:** AC-DC POWER SUPPLY

**FEATURES**

- 5 W power
- DoE Level VI, CoC Tier 2 efficiency
- universal input (90~264 Vac)
- single regulated 5 Vdc output
- over voltage, over current, and short circuit protections
- UL/cUL, PSE safety approvals



<b>MODEL</b>	<b>output voltage</b> (Vdc)	<b>output current max</b> (A)	<b>output power max</b> (W)	<b>ripple and noise<sup>1</sup> max</b> (mVp-p)	<b>efficiency level<sup>2</sup></b>
SWI5-5-N-I38	5	1	5	300	VI

Notes: 1. At full load, nominal input, 25 °C, 20 MHz bandwidth oscilloscope, each output terminated with 0.1 µF ceramic and 10 µF electrolytic capacitors.  
2. CoC Tier 2 complaint

**PART NUMBER KEY**

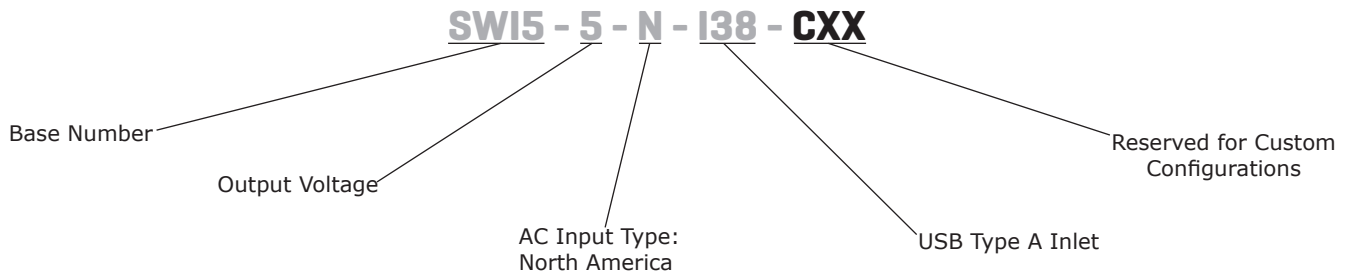

## INPUT

parameter	conditions/description	min	typ	max	units
voltage		90		264	Vac
frequency		47		63	Hz
current				0.2	A
leakage current				0.02	mA
no load power consumption	at 115/230 Vac, 50/60 Hz Level VI CoC Tier 2			0.075 0.075	W W

## OUTPUT

parameter	conditions/description	min	typ	max	units
line regulation			±5		%
load regulation			±5		%
start-up time				3	s

## PROTECTIONS

parameter	conditions/description	min	typ	max	units
over voltage protection				10	Vdc
over current protection	auto recovery			1.5	A
short circuit protection					

## SAFETY & COMPLIANCE

parameter	conditions/description	min	typ	max	units
isolation voltage	input to output at 10 mA for 1 minute		3,000 4,242		Vac Vdc
safety approvals	UL/cUL (62368), LPS, PSE				
EMI/EMC	FCC Part 15 Class B				
MTBF	as per Telcordia SR-332, Issue 2, at 115/230 Vac, full load, 0~40°C	50,000			hours
RoHS	2011/65/EU				

## ENVIRONMENTAL

parameter	conditions/description	min	typ	max	units
operating temperature		0		40	°C
storage temperature		-20		60	°C
operating humidity	non-condensing	20		85	%
storage humidity	non-condensing	5		95	%

## MECHANICAL

parameter	conditions/description	min	typ	max	units
dimensions	64.92 x 36 x 22.5				mm
input plug	North America, 2-pin				
weight			80		g

## MECHANICAL DRAWING

units: mm  
tolerance: ±0.5 mm

PIN	Output Voltage
1	+5V
2	Short
3	Short
4	GND

+5	1
GND	4

## REVISION HISTORY

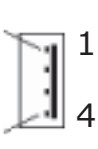
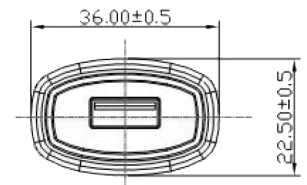
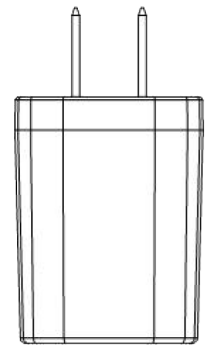
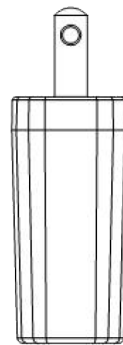
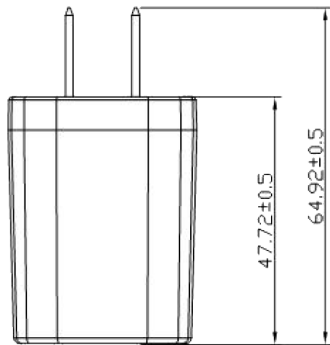
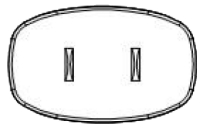
rev.	description	date
1.0	initial release	04/30/2015
1.01	updated datasheet	09/14/2016
1.02	safety approval update	07/15/2020
1.03	safety marks updated	04/22/2021

The revision history provided is for informational purposes only and is believed to be accurate.



**CUI INC**

a bel group

**Headquarters**  
20050 SW 112th Ave.  
Tualatin, OR 97062  
**800.275.4899**

Fax 503.612.2383  
**cui.com**  
techsupport@cui.com

This device complies with part 15 of the FCC Rules. Operation is subject to the following two conditions:

- (1) This device may not cause harmful interference, and
- (2) this device must accept any interference received, including interference that may cause undesired operation.

CUI offers a one (1) year limited warranty. Complete warranty information is listed on our website.

CUI reserves the right to make changes to the product at any time without notice. Information provided by CUI is believed to be accurate and reliable. However, no responsibility is assumed by CUI for its use, nor for any infringements of patents or other rights of third parties which may result from its use.

CUI products are not authorized or warranted for use as critical components in equipment that requires an extremely high level of reliability. A critical component is any component of a life support device or system whose failure to perform can be reasonably expected to cause the failure of the life support device or system, or to affect its safety or effectiveness.