

## P-Channel 80 V (D-S) MOSFET

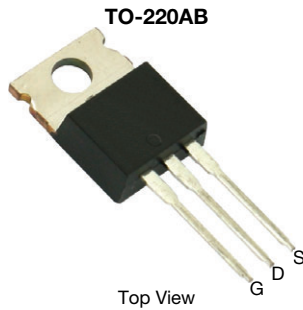

### FEATURES

- TrenchFET® power MOSFET
- Package with low thermal resistance
- Maximum 175 °C junction temperature
- Low  $R_{DS(on)}$  minimizes power loss from conduction
- Compatible with logic-level gate driving
- 100 %  $R_g$  and UIS tested
- Material categorization: for definitions of compliance please see [www.vishay.com/doc?99912](http://www.vishay.com/doc?99912)



**RoHS**  
COMPLIANT  
HALOGEN  
**FREE**

PRODUCT SUMMARY	
$V_{DS}$ (V)	-80
$R_{DS(on)}$ max. ( $\Omega$ ) at $V_{GS} = -10$ V	0.0058
$R_{DS(on)}$ max. ( $\Omega$ ) at $V_{GS} = -4.5$ V	0.0081
$Q_g$ typ. (nC)	145
$I_D$ (A)	-150
Configuration	Single

### APPLICATIONS

- Battery protection
- Motor drive control
- Load switch

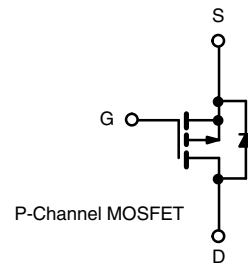

ORDERING INFORMATION	
Package	TO-220AB
Lead (Pb)-free and halogen-free	SUP60061EL-GE3

ABSOLUTE MAXIMUM RATINGS ( $T_C = 25$ °C, unless otherwise noted)				
PARAMETER		SYMBOL	LIMIT	UNIT
Drain-source voltage		$V_{DS}$	-80	V
Gate-source voltage		$V_{GS}$	$\pm 20$	
Continuous drain current <sup>d</sup> ( $T_J = 175$ °C)	$T_C = 25$ °C	$I_D$	-150 <sup>d</sup>	A
	$T_C = 70$ °C		-150 <sup>d</sup>	
Pulsed drain current (100 $\mu$ s)		$I_{DM}$	-250	
Avalanche current	L = 0.1 mH	$I_{AS}$	-75	
Single pulse avalanche energy <sup>a</sup>		$E_{AS}$	281	mJ
Power dissipation	$T_C = 25$ °C <sup>c</sup>	$P_D$	375	W
	$T_C = 125$ °C <sup>b</sup>		125	
Operating junction and storage temperature range		$T_J, T_{stg}$	-55 to +175	°C

THERMAL RESISTANCE RATINGS				
PARAMETER		SYMBOL	LIMIT	UNIT
Junction-to-ambient	PCB mount <sup>b</sup>	$R_{thJA}$	40	°C/W
Junction-to-case		$R_{thJC}$	0.4	

### Notes

- Duty cycle  $\leq 1$  %
- When mounted on 1" square PCB (FR4 material)
- See SOA curve for voltage derating
- Limited by package



SPECIFICATIONS (T <sub>J</sub> = 25 °C, unless otherwise noted)						
PARAMETER	SYMBOL	TEST CONDITIONS	MIN.	TYP.	MAX.	UNIT
<b>Static</b>						
Drain-source breakdown voltage	V <sub>DS</sub>	V <sub>GS</sub> = 0 V, I <sub>D</sub> = -10 mA	-80	-	-	V
Gate threshold voltage	V <sub>GS(th)</sub>	V <sub>DS</sub> = V <sub>GS</sub> , I <sub>D</sub> = -250 μA	-1.5	-	-2.5	
Gate-body leakage	I <sub>GSS</sub>	V <sub>DS</sub> = 0 V, V <sub>GS</sub> = ± 20 V	-	-	± 100	nA
Zero gate voltage drain current	I <sub>DSS</sub>	V <sub>DS</sub> = -80 V, V <sub>GS</sub> = 0 V	-	-	-10	μA
		V <sub>DS</sub> = -64 V, V <sub>GS</sub> = 0 V, T <sub>J</sub> = 125 °C	-	-	-50	
		V <sub>DS</sub> = -64 V, V <sub>GS</sub> = 0 V, T <sub>J</sub> = 175 °C	-	-	-250	
On-state drain current <sup>a</sup>	I <sub>D(on)</sub>	V <sub>DS</sub> ≤ -5 V, V <sub>GS</sub> = -10 V	-30	-	-	A
Drain-source on-state resistance <sup>a</sup>	R <sub>DS(on)</sub>	V <sub>GS</sub> = -10 V, I <sub>D</sub> = -20 A	-	0.0048	0.0058	Ω
		V <sub>GS</sub> = -4.5 V, I <sub>D</sub> = -15 A	-	0.0065	0.0081	
Forward transconductance <sup>a</sup>	g <sub>fs</sub>	V <sub>DS</sub> = -15 V, I <sub>D</sub> = -15 A	-	80	-	S
<b>Dynamic <sup>b</sup></b>						
Input capacitance	C <sub>iss</sub>	V <sub>GS</sub> = 0 V, V <sub>DS</sub> = -40 V, f = 1 MHz	-	9600	-	pF
Output capacitance	C <sub>oss</sub>		-	3300	-	
Reverse transfer capacitance	C <sub>rss</sub>		-	110	-	
Total gate charge <sup>c</sup>	Q <sub>g</sub>	V <sub>DS</sub> = -40 V, V <sub>GS</sub> = -10 V, I <sub>D</sub> = -110 A	-	145	218	nC
Gate-source charge <sup>c</sup>	Q <sub>gs</sub>		-	34	-	
Gate-drain charge <sup>c</sup>	Q <sub>gd</sub>		-	16	-	
Gate resistance	R <sub>g</sub>	f = 1 MHz	0.46	2.3	4.6	Ω
Turn-on delay time <sup>c</sup>	t <sub>d(on)</sub>	V <sub>DD</sub> = -40 V, R <sub>L</sub> = 0.71 Ω I <sub>D</sub> ≅ -20 A, V <sub>GEN</sub> = -10 V, R <sub>g</sub> = 1 Ω	-	25	35	ns
Rise time <sup>c</sup>	t <sub>r</sub>		-	20	30	
Turn-off delay time <sup>c</sup>	t <sub>d(off)</sub>		-	90	140	
Fall time <sup>c</sup>	t <sub>f</sub>		-	20	30	
<b>Drain-Source Body Diode Characteristics (T<sub>C</sub> = 25 °C <sup>b</sup>)</b>						
Continuous current	I <sub>S</sub>		-	-	-150	A
Pulsed current	I <sub>SM</sub>		-	-	-250	
Forward voltage <sup>a</sup>	V <sub>SD</sub>	I <sub>F</sub> = -10 A, V <sub>GS</sub> = 0 V	-	-0.8	-1.5	V
Reverse recovery time	t <sub>rr</sub>	I <sub>F</sub> = -20 A, di/dt = 100 A/μs	-	90	135	ns
Peak reverse recovery charge	I <sub>RM(REC)</sub>		-	-2.8	-4.2	A
Reverse recovery charge	Q <sub>rr</sub>		-	145	218	nC

**Notes**

- Pulse test; pulse width ≤ 300 μs, duty cycle ≤ 2 %
- Guaranteed by design, not subject to production testing
- Independent of operating temperature

Stresses beyond those listed under "Absolute Maximum Ratings" may cause permanent damage to the device. These are stress ratings only, and functional operation of the device at these or any other conditions beyond those indicated in the operational sections of the specifications is not implied. Exposure to absolute maximum rating conditions for extended periods may affect device reliability.



TYPICAL CHARACTERISTICS (T<sub>A</sub> = 25 °C, unless otherwise noted)

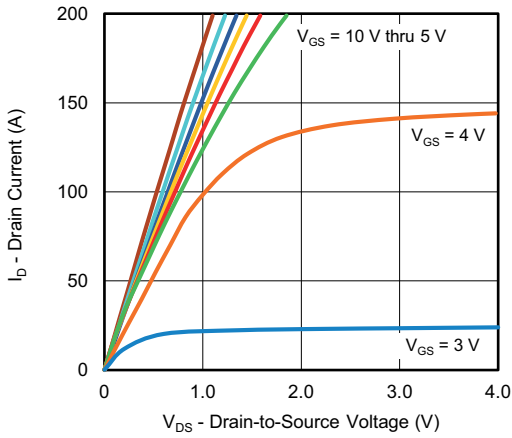

Output Characteristics

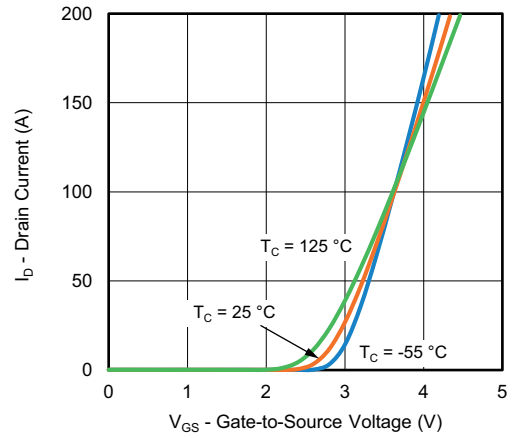

Transfer Characteristics

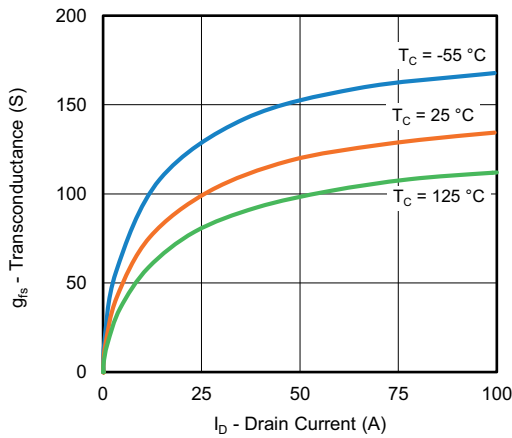

Transconductance

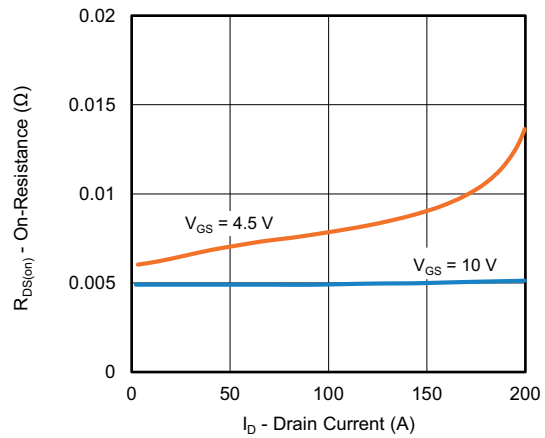

On-Resistance vs. Drain Current

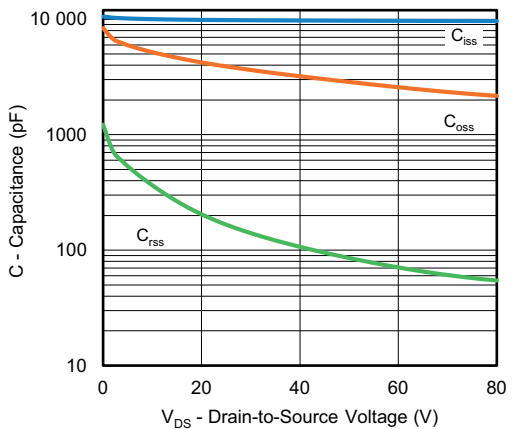

Capacitance

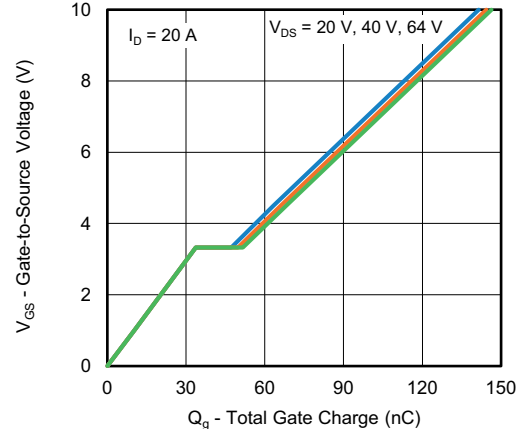

Gate Charge



TYPICAL CHARACTERISTICS (T<sub>A</sub> = 25 °C, unless otherwise noted)

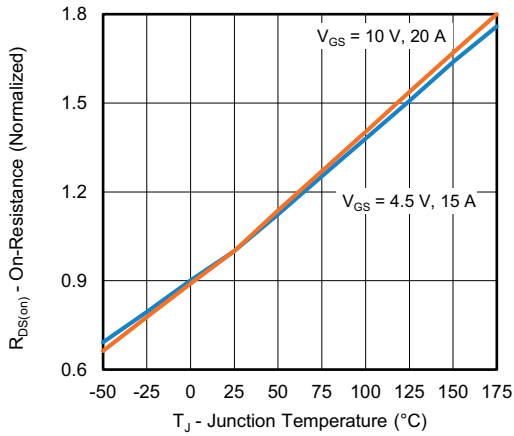

On-Resistance vs. Junction Temperature

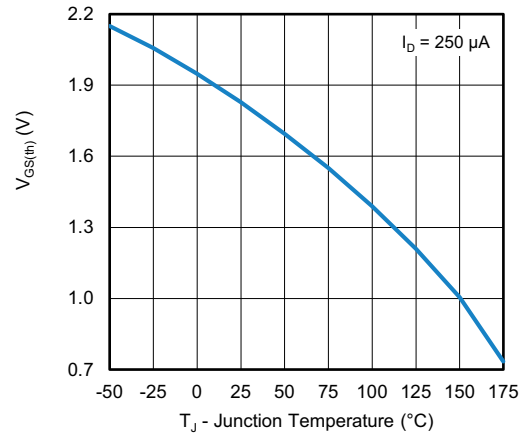

Threshold Voltage

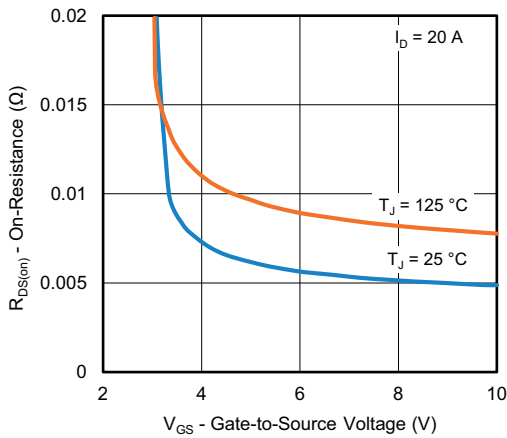

On-Resistance vs. Gate-to-Source Voltage

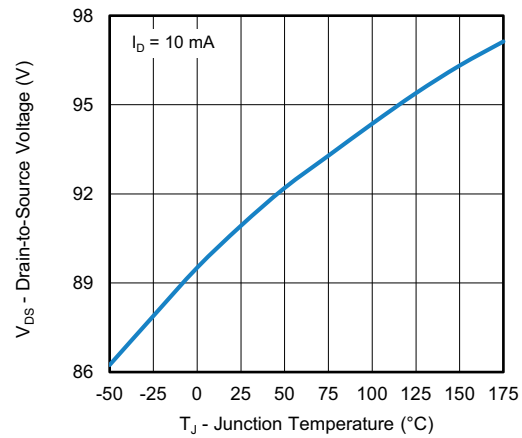

Drain Source Breakdown vs. Junction Temperature

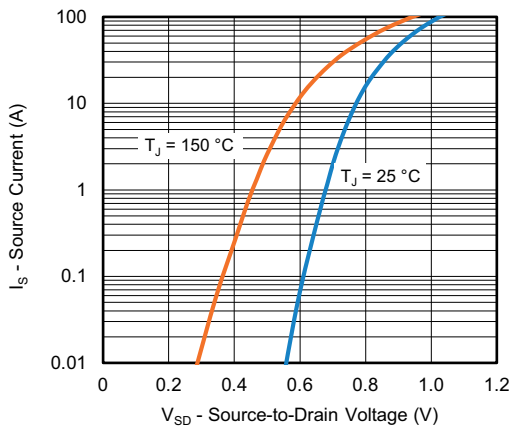

Source Drain Diode Forward Voltage

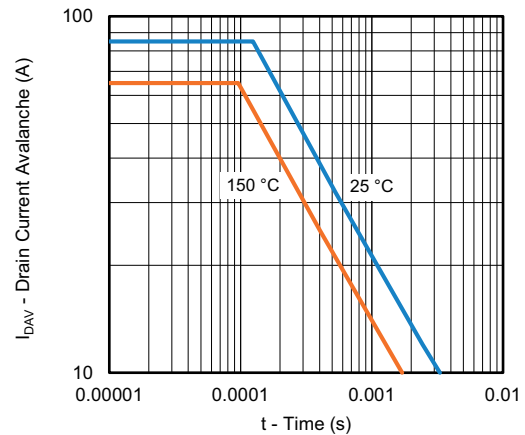

Avalanche Current vs. Time



**THERMAL RATINGS** ( $T_A = 25\text{ }^\circ\text{C}$ , unless otherwise noted)

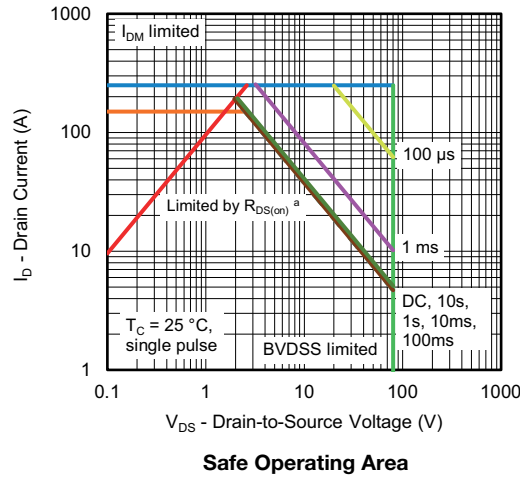

**Note**

a.  $V_{GS} >$  minimum  $V_{GS}$  at which  $R_{DS(on)}$  is specified

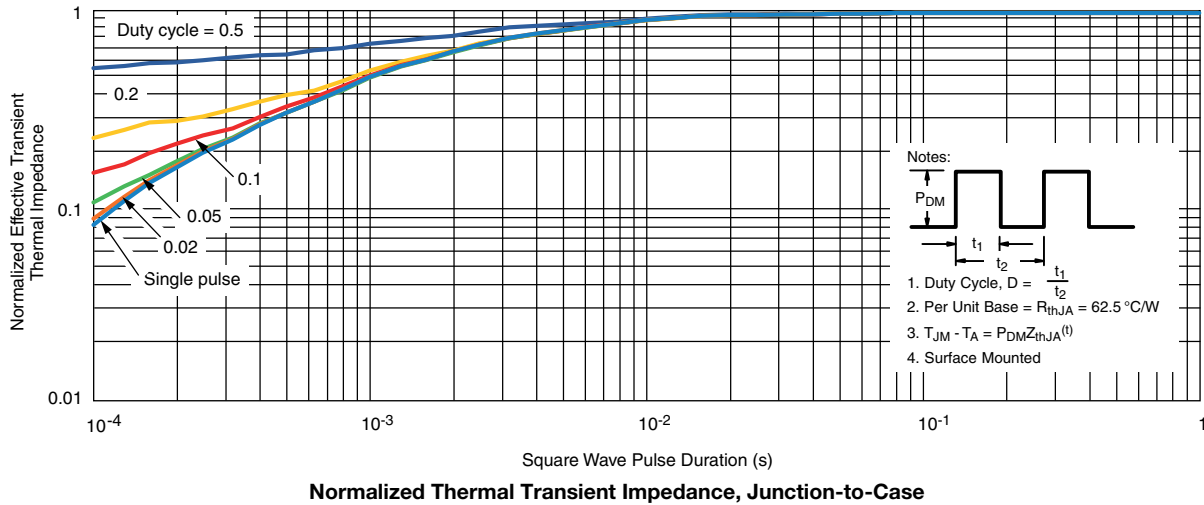

Vishay Siliconix maintains worldwide manufacturing capability. Products may be manufactured at one of several qualified locations. Reliability data for Silicon Technology and Package Reliability represent a composite of all qualified locations. For related documents such as package / tape drawings, part marking, and reliability data, see [www.vishay.com/ppg?63020](http://www.vishay.com/ppg?63020).



## TO-220AB



DIM.	MILLIMETERS		INCHES	
	MIN.	MAX.	MIN.	MAX.
A	4.25	4.65	0.167	0.183
b	0.69	1.01	0.027	0.040
b(1)	1.20	1.73	0.047	0.068
c	0.36	0.61	0.014	0.024
D	14.85	15.49	0.585	0.610
D2	12.19	12.70	0.480	0.500
E	10.04	10.51	0.395	0.414
e	2.41	2.67	0.095	0.105
e(1)	4.88	5.28	0.192	0.208
F	1.14	1.40	0.045	0.055
H(1)	6.09	6.48	0.240	0.255
J(1)	2.41	2.92	0.095	0.115
L	13.35	14.02	0.526	0.552
L(1)	3.32	3.82	0.131	0.150
$\varnothing P$	3.54	3.94	0.139	0.155
Q	2.60	3.00	0.102	0.118

ECN: T14-0413-Rev. P, 16-Jun-14  
DWG: 5471

**Note**

\* M = 1.32 mm to 1.62 mm (dimension including protrusion)  
Heatsink hole for HVM

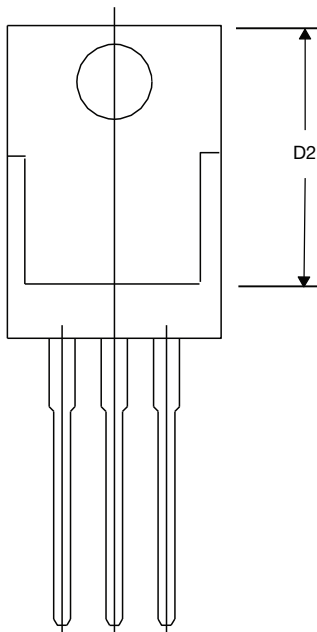



## Disclaimer

ALL PRODUCT, PRODUCT SPECIFICATIONS AND DATA ARE SUBJECT TO CHANGE WITHOUT NOTICE TO IMPROVE RELIABILITY, FUNCTION OR DESIGN OR OTHERWISE.

Vishay Intertechnology, Inc., its affiliates, agents, and employees, and all persons acting on its or their behalf (collectively, "Vishay"), disclaim any and all liability for any errors, inaccuracies or incompleteness contained in any datasheet or in any other disclosure relating to any product.

Vishay makes no warranty, representation or guarantee regarding the suitability of the products for any particular purpose or the continuing production of any product. To the maximum extent permitted by applicable law, Vishay disclaims (i) any and all liability arising out of the application or use of any product, (ii) any and all liability, including without limitation special, consequential or incidental damages, and (iii) any and all implied warranties, including warranties of fitness for particular purpose, non-infringement and merchantability.

Statements regarding the suitability of products for certain types of applications are based on Vishay's knowledge of typical requirements that are often placed on Vishay products in generic applications. Such statements are not binding statements about the suitability of products for a particular application. It is the customer's responsibility to validate that a particular product with the properties described in the product specification is suitable for use in a particular application. Parameters provided in datasheets and / or specifications may vary in different applications and performance may vary over time. All operating parameters, including typical parameters, must be validated for each customer application by the customer's technical experts. Product specifications do not expand or otherwise modify Vishay's terms and conditions of purchase, including but not limited to the warranty expressed therein.

Hyperlinks included in this datasheet may direct users to third-party websites. These links are provided as a convenience and for informational purposes only. Inclusion of these hyperlinks does not constitute an endorsement or an approval by Vishay of any of the products, services or opinions of the corporation, organization or individual associated with the third-party website. Vishay disclaims any and all liability and bears no responsibility for the accuracy, legality or content of the third-party website or for that of subsequent links.

Except as expressly indicated in writing, Vishay products are not designed for use in medical, life-saving, or life-sustaining applications or for any other application in which the failure of the Vishay product could result in personal injury or death. Customers using or selling Vishay products not expressly indicated for use in such applications do so at their own risk. Please contact authorized Vishay personnel to obtain written terms and conditions regarding products designed for such applications.

No license, express or implied, by estoppel or otherwise, to any intellectual property rights is granted by this document or by any conduct of Vishay. Product names and markings noted herein may be trademarks of their respective owners.