

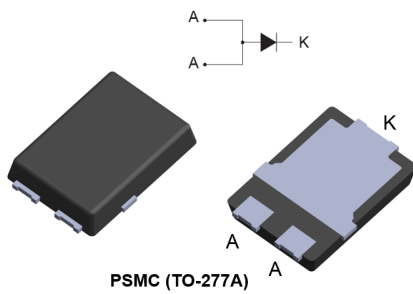

Automotive 100 V low I_r power Schottky rectifier

Features

- AEC-Q101 qualified 
- Low leakage current
- Negligible switching losses
- Avalanche capability specified
- 175 °C maximum junction temperature
- V_{RRM} guaranteed from -40 °C to 175 °C
- Wettable flanks for automatic visual inspection
- PPAP capable
- ECOPACK[®]2 compliant component

Application

- DC/DC converters
- Reverse polarity protection
- Freewheeling diodes
- Switching diodes

Description

The [STPS5H100SFY](#) power Schottky rectifier has been designed for automotive applications.

Packaged in PSMC (TO-277A), this device provides a very low V_F in a compact package which can withstand high operating junction temperature.

Product status link	
STPS5H100SFY	
Product summary	
Symbol	Value
$I_{F(AV)}$	5 A
V_{RRM}	100 V
T_j (max.)	175 °C
V_F (typ.)	0.545 V

1 Characteristics

Table 1. Absolute ratings (limiting values at 25 °C, unless otherwise specified with 2 anode terminals short-circuited)

Symbol	Parameter	Value	Unit
V _{RRM}	Repetitive peak reverse voltage (T _j = -40 °C to +175 °C)	100	V
I _{F(AV)}	Average forward current, δ = 0.5	T _c = 160 °C	A
I _{FSM}	Surge non repetitive forward current	t _p = 10 ms sinusoidal	A
P _{ARM}	Repetitive peak avalanche power	t _p = 10 μs, T _j = 125 °C	W
T _{stg}	Storage temperature range	-65 to +175	°C
T _j	Operating junction temperature range ⁽¹⁾	-40 to +175	°C

1. $(dP_{tot}/dT_j) < (1/R_{th(j-a)})$ condition to avoid thermal runaway for a diode on its own heatsink.

Table 2. Thermal resistance parameters

Symbol	Parameter	Typ.	Unit
R _{th(j-c)}	Junction to case	2.1	°C/W

For more information, please refer to the following application note:

- AN5088: Rectifiers thermal management, handling and mounting recommendations

Table 3. Static electrical characteristics (anode terminals short-circuited)

Symbol	Parameter	Test conditions	Min.	Typ.	Max.	Unit
I _R ⁽¹⁾	Reverse leakage current	T _j = 25 °C	-		8	μA
		T _j = 125 °C	-	1.5	5	mA
V _F ⁽²⁾	Forward voltage drop	T _j = 25 °C	-		0.64	V
		T _j = 125 °C	-	0.48	0.54	
		T _j = 25 °C	-		0.745	
		T _j = 125 °C	-	0.545	0.610	

1. Pulse test: t_p = 5 ms, δ < 2%

2. Pulse test: t_p = 380 μs, δ < 2%

To evaluate the conduction losses, use the following equation:

$$P = 0.47 \times I_{F(AV)} + 0.028 \times I_{F(RMS)}^2$$

For more information, please refer to the following application notes related to the power losses:

- AN604: Calculation of conduction losses in a power rectifier
- AN4021: Calculation of reverse losses in a power diode

1.1 Characteristics (curves)

Figure 1. Average forward current versus case temperature ($\delta = 0.5$)

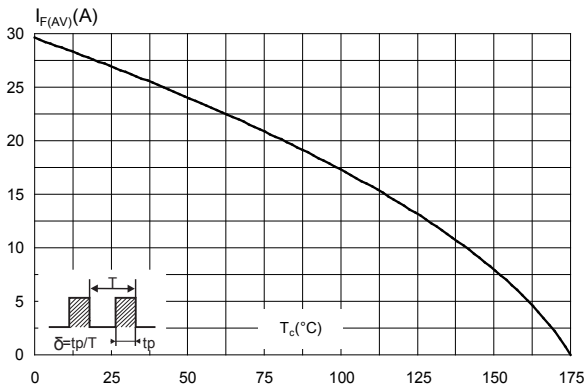

Figure 2. Relative variation of thermal impedance junction to case versus pulse duration

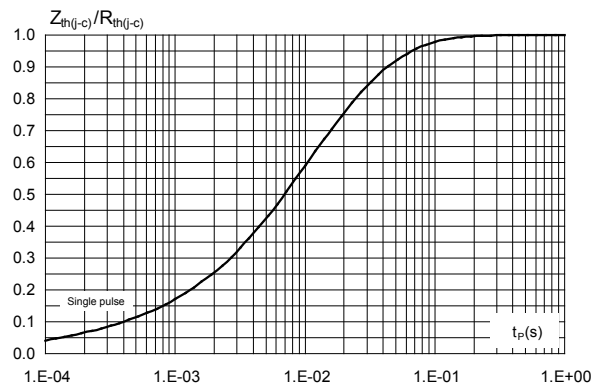

Figure 3. Reverse leakage current versus reverse voltage applied (typical values)

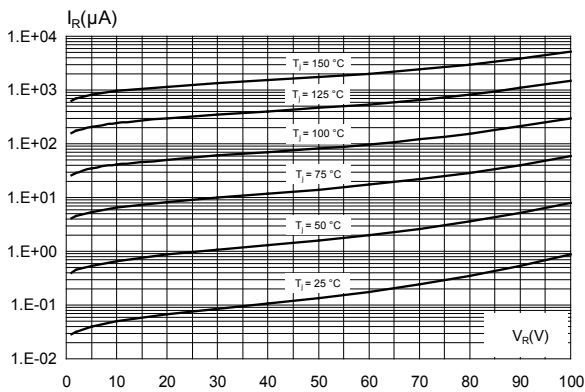

Figure 4. Junction capacitance versus reverse voltage applied (typical values)

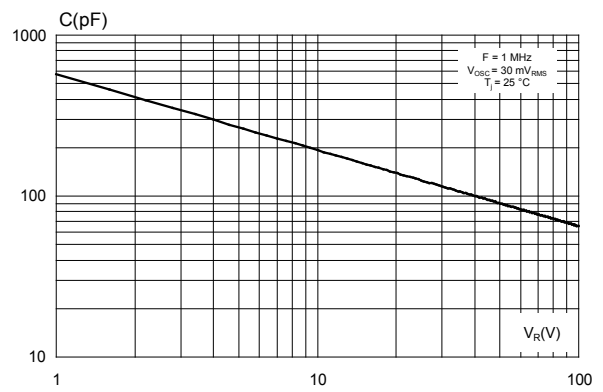

Figure 5. Forward voltage drop versus forward current (typical values)

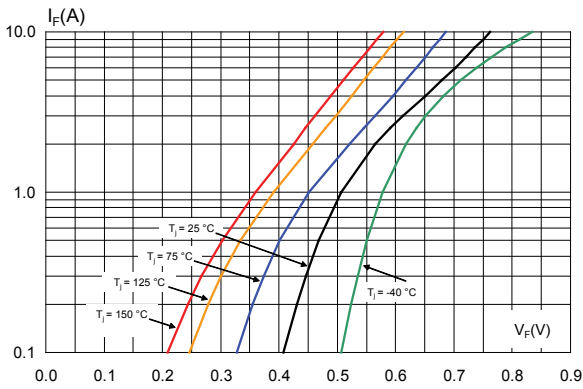

Figure 6. Normalized avalanche power derating versus pulse duration ($T_j = 125^\circ\text{C}$)

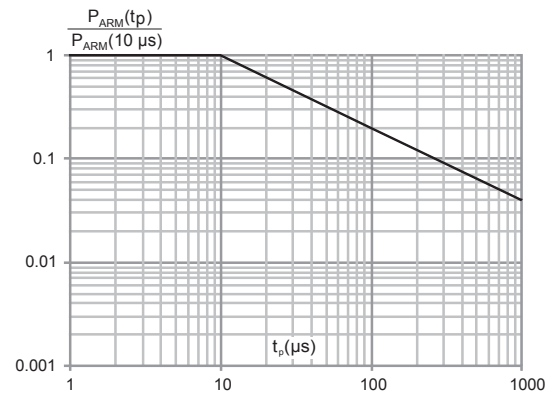
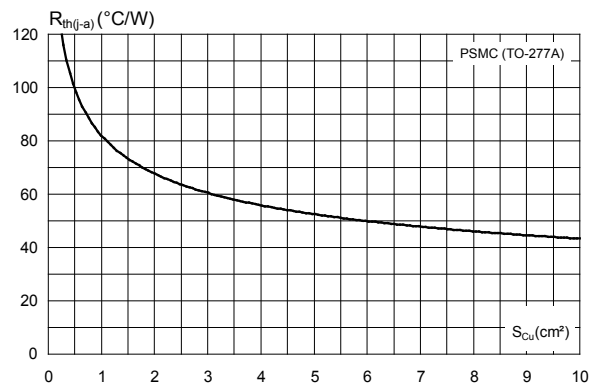

Figure 7. Thermal resistance junction to ambient versus copper surface under tab (typical values, epoxy printed board FR4, $e_{\text{Cu}} = 35 \mu\text{m}$) (PSMC (TO-277A))



2 Package information

In order to meet environmental requirements, ST offers these devices in different grades of **ECOPACK®** packages, depending on their level of environmental compliance. ECOPACK® specifications, grade definitions and product status are available at: www.st.com. ECOPACK® is an ST trademark.

2.1 PSMC (TO-277A) package information

- Epoxy meets UL94,V0
- Cooling method : by conduction (C)

Figure 8. PSMC (TO-277A) package outline

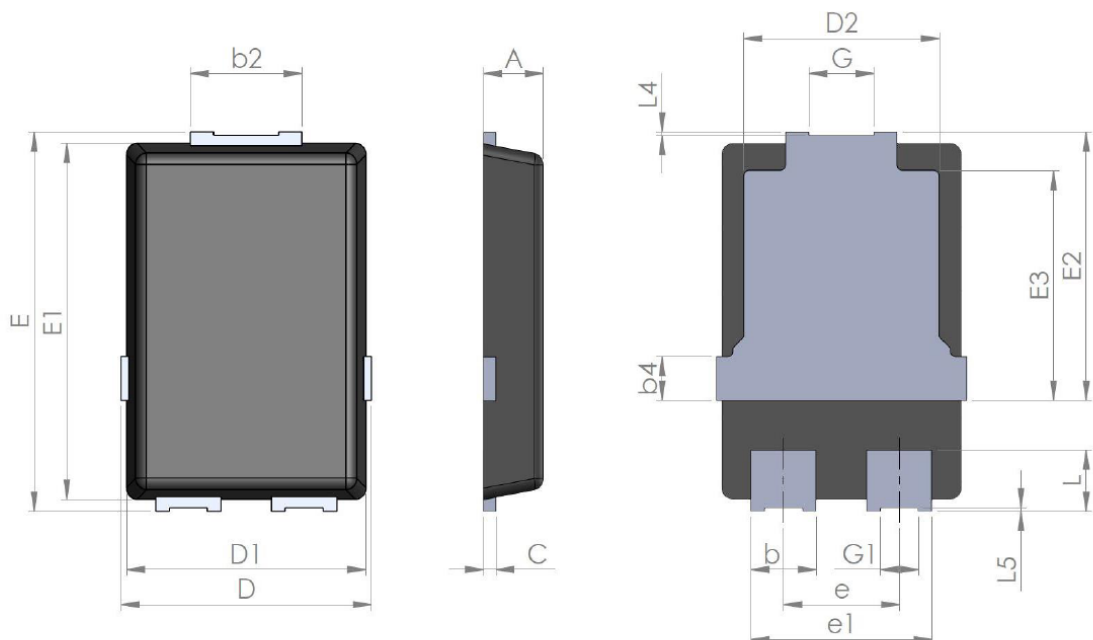

Table 4. PSMC (TO-277A) package mechanical data

Ref.	Dimensions					
	Millimeters			Inches (for reference only)		
	Min.	Typ.	Max.	Min.	Typ.	Max.
A	1.00	1.10	1.20	0.039	0.043	0.047
b	1.05	1.20	1.35	0.041	0.047	0.053
b2	1.90	2.05	2.20	0.075	0.081	0.087
b4		0.75			0.029	
C	0.15	0.23	0.40	0.006	0.009	0.016
D	4.45	4.60	4.75	0.175	0.181	0.187
D1	4.25	4.40	4.45	0.167	0.173	0.175
D2	3.40	3.60	3.70	0.134	0.142	0.146
E	6.35	6.50	6.65	0.250	0.256	0.262
E1	6.05	6.10	6.15	0.238	0.240	0.242
E2	4.50	4.60	4.70	0.177	0.181	0.185
E3		3.94			1.55	
e		2.13			0.084	
e1		3.33			0.131	
G		1.20			0.047	
G1		0.70			0.027	
L	0.90	1.05	1.24	0.035	0.041	0.049
L4	0.02			0.0008		
L5	0.02			0.0008		

Figure 9. PSMC (TO-277A) package footprint in mm (in inches)

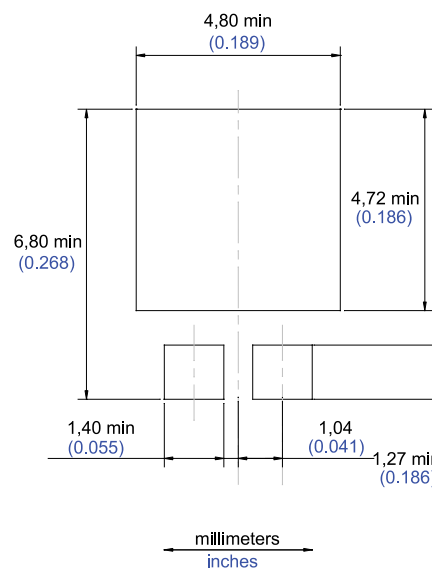
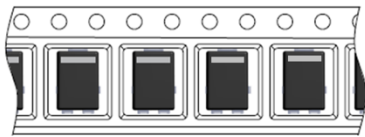

Figure 10. PSMC (TO-277A) marking



Figure 11. Package orientation in reel



Taped according to EIA-481
Note: Pocket dimensions are not on scale
Pocket shape may vary depending on package
Cathode band only on unidirectional devices

Figure 12. Tape and reel orientation

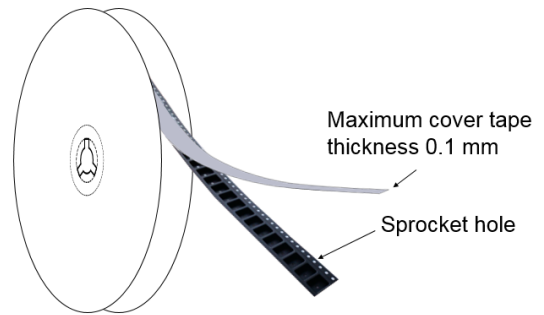

Figure 13. 13" reel dimension values

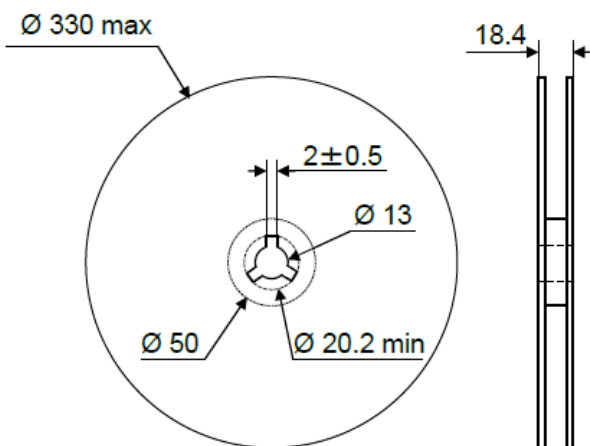

Figure 14. Inner box dimension values

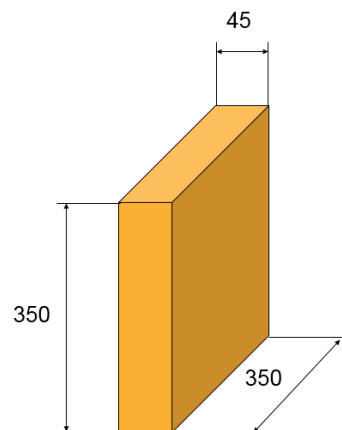
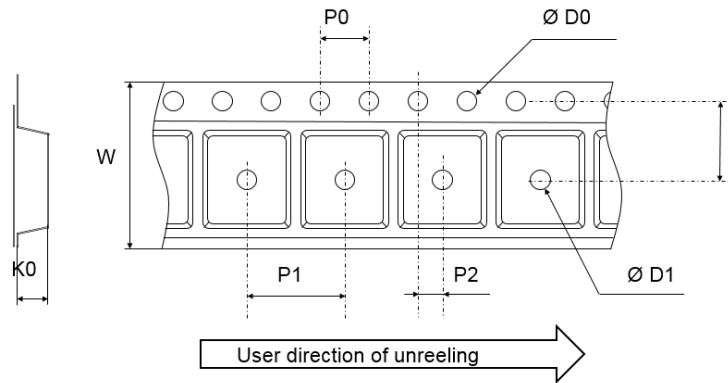

Figure 15. Tape outline



Note: Pocket dimensions are not on scale
Pocket shape may vary depending on package

Table 5. Tape dimension values

Ref.	Dimensions		
	Millimeters		
	Min.	Typ.	Max.
D0	1.5	1.55	1.6
D1	1.5		
F	5.45	5.5	5.55
K0	1.3	1.4	1.5
P0	3.9	4.0	4.1
P1	7.9	8.0	8.1
P2	1.95	2.0	2.05
W	11.7	12	12.3

3 Ordering information

Table 6. Ordering information

Order code	Marking	Package	Weight	Base qty.	Delivery mode
STPS5H100SFY	S5H100Y	PSMC (TO-277A)	90 mg	6000	Tape and Reel

Revision history

Table 7. Document revision history

Date	Version	Changes
06-Aug-2018	1	Initial release.
07-Nov-2018	2	Updated Table 6 . Ordering information.

IMPORTANT NOTICE – PLEASE READ CAREFULLY

STMicroelectronics NV and its subsidiaries (“ST”) reserve the right to make changes, corrections, enhancements, modifications, and improvements to ST products and/or to this document at any time without notice. Purchasers should obtain the latest relevant information on ST products before placing orders. ST products are sold pursuant to ST’s terms and conditions of sale in place at the time of order acknowledgement.

Purchasers are solely responsible for the choice, selection, and use of ST products and ST assumes no liability for application assistance or the design of Purchasers’ products.

No license, express or implied, to any intellectual property right is granted by ST herein.

Resale of ST products with provisions different from the information set forth herein shall void any warranty granted by ST for such product.

ST and the ST logo are trademarks of ST. All other product or service names are the property of their respective owners.

Information in this document supersedes and replaces information previously supplied in any prior versions of this document.

© 2018 STMicroelectronics – All rights reserved