

150 V, 3 A power Schottky rectifier

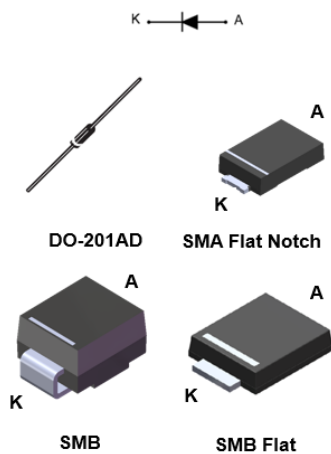

Features

- Negligible switching losses
- Low forward voltage drop for higher efficiency and extended battery life
- Surface mount miniature package
- Low thermal resistance
- **ECOPACK2** component

Applications

- LED Lighting
- Battery charger
- DC / DC converter
- Notebook adapter
- Switching diode

Description

150 V power Schottky rectifier are suited for switch mode power supplies on up to 24 V rails and high frequency converters.

Packaged in axial, SMB, SMA Flat Notch and SMB Flat, the **STPS3150** is ideal for use in consumer and computer applications like TV, STB, PC and DVD where low drop forward voltage is required to reduce power dissipation.

Product status	
STPS3150	
Product summary	
Symbol	Value
$I_{F(AV)}$	3 A
V_{RRM}	150 V
$T_{j(max.)}$	175 °C
$V_{F(typ.)}$	0.63 V

1 Characteristics

Table 1. Absolute ratings (limiting values at 25 °C, unless otherwise specified)

Symbol	Parameter		Value	Unit	
V _{RRM}	Repetitive peak reverse voltage		150	V	
I _{F(AV)}	Average forward current, $\delta = 0.5$, square wave	SMA Flat Notch	T _L = 130 °C	3	A
		SMB	T _L = 130 °C		
		SMB Flat	T _L = 150 °C		
		DO-201AD	T _L = 140 °C		
I _{FSM}	Surge non repetitive forward current	SMA Flat Notch	t _p = 10 ms sinusoidal	75	A
		SMB		80	
		SMB Flat		80	
		DO-201AD		100	
P _{ARM}	Repetitive peak avalanche power		t _p = 10 μ s, T _j = 125 °C	210	W
T _{stg}	Storage temperature range		-65 to +175	°C	
T _j	Maximum operating junction temperature ⁽¹⁾		+175	°C	

1. $(dP_{tot}/dT_j) < (1/R_{th(j-a)})$ condition to avoid thermal runaway for a diode on its own heatsink.

Table 2. Thermal resistance parameter

Symbol	Parameter		Max. value	Unit
R _{th(j-l)}	Junction to lead	SMA Flat Notch	20	°C/W
		SMB	20	
		SMB Flat	10	
	Junction to lead, lead length = 10 mm	DO-201AD	15	

For more information, please refer to the following application note :

- AN5088 : Rectifiers thermal management, handling and mounting recommendations

Table 3. Static electrical characteristics

Symbol	Parameter	Test conditions		Min.	Typ.	Max.	Unit
I _R ⁽¹⁾	Reverse leakage current	T _j = 25 °C	V _R = V _{RM}	-	0.4	2.0	μ A
		T _j = 125 °C		-	0.6	2.0	mA
V _F ⁽²⁾	Forward voltage drop	T _j = 25 °C	I _F = 3 A	-	0.78	0.82	V
		T _j = 125 °C		-	0.63	0.67	
		T _j = 25 °C	I _F = 6 A	-	0.85	0.89	
		T _j = 125 °C		-	0.70	0.75	

1. Pulse test: t_p = 5 ms, $\delta < 2\%$

2. Pulse test: t_p = 380 μ s, $\delta < 2\%$

To evaluate the conduction losses, use the following equation:

$$P = 0.59 \times I_{F(AV)} + 0.027 \times I_{F(RMS)}^2$$

For more information, please refer to the following application notes related to the power losses :

- AN604: Calculation of conduction losses in a power rectifier
- AN4021: Calculation of reverse losses on a power diode

1.1 Characteristics (curves)

Figure 1. Average forward power dissipation versus average forward current

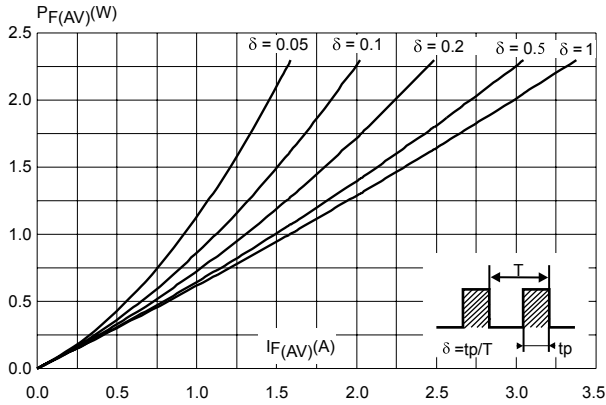

Figure 2. Average forward current versus ambient temperature ($\delta = 0.5$)

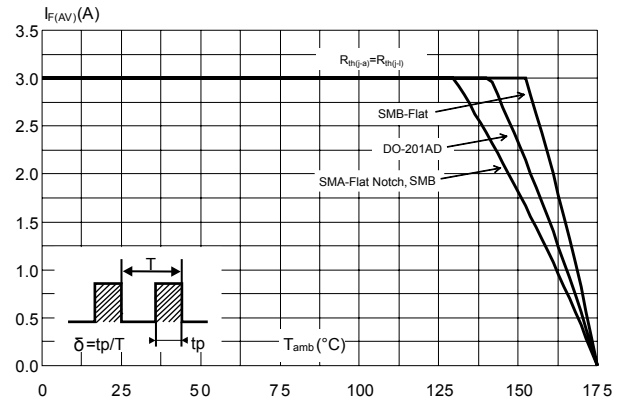

Figure 3. Normalized avalanche power derating versus pulse duration ($T_j = 125^\circ\text{C}$)

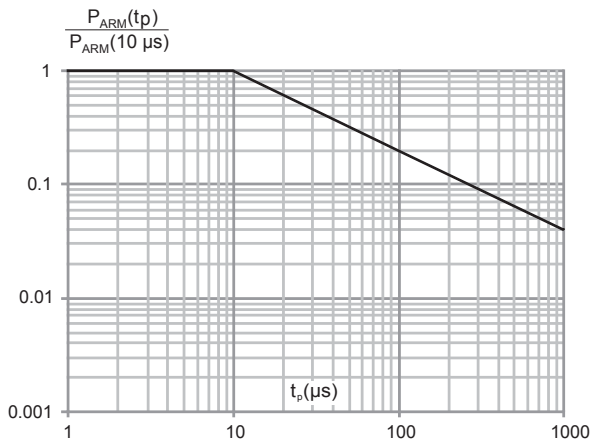

Figure 4. Relative variation of thermal impedance junction to ambient versus pulse duration (SMB)

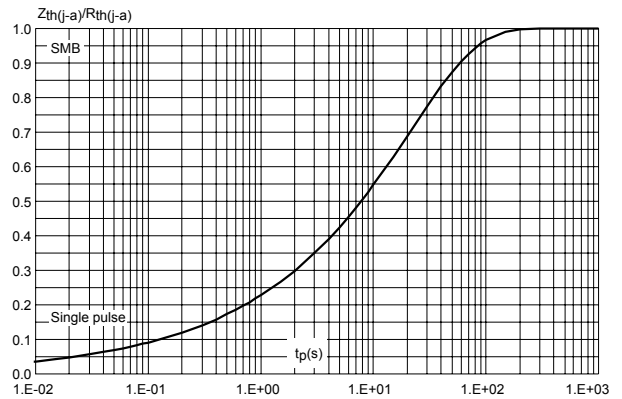

Figure 5. Relative variation of thermal impedance junction to lead versus pulse duration (SMB flat)

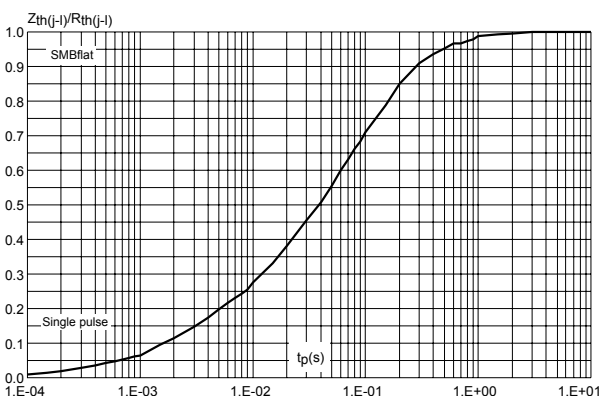

Figure 6. Relative variation of thermal impedance junction to ambient versus pulse duration (DO-201AD)

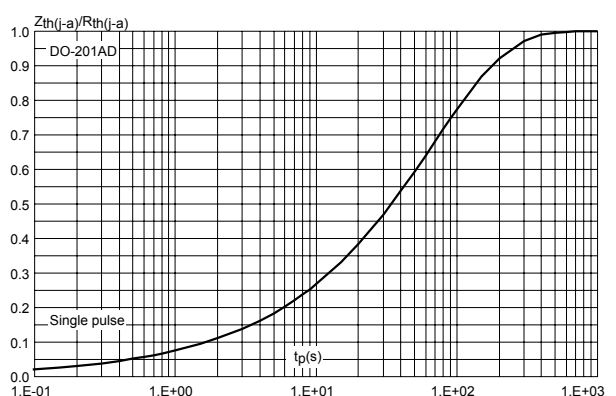

Figure 7. Reverse leakage current versus reverse voltage applied (typical values)

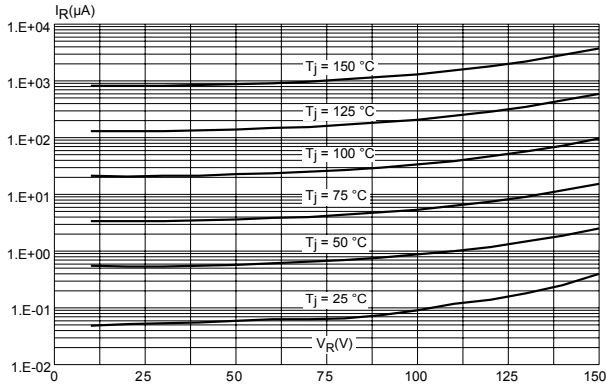

Figure 8. Junction capacitance versus reverse voltage applied (typical values)

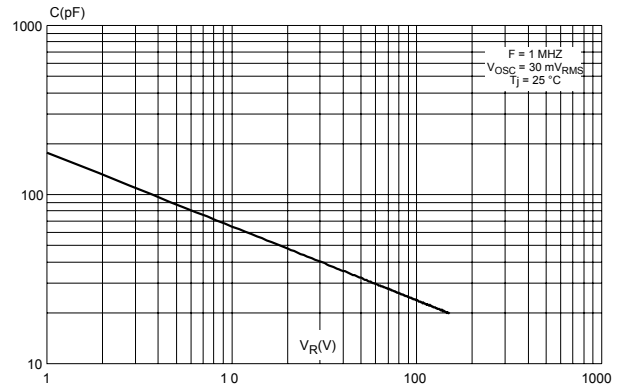

Figure 9. Forward voltage drop versus forward current

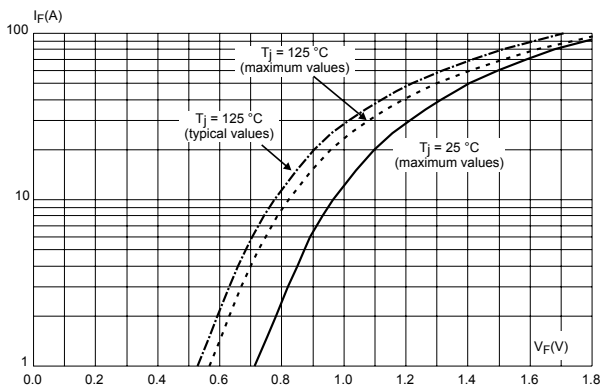

Figure 10. Thermal resistance junction to ambient versus copper surface under each lead (SMA Flat Notch)

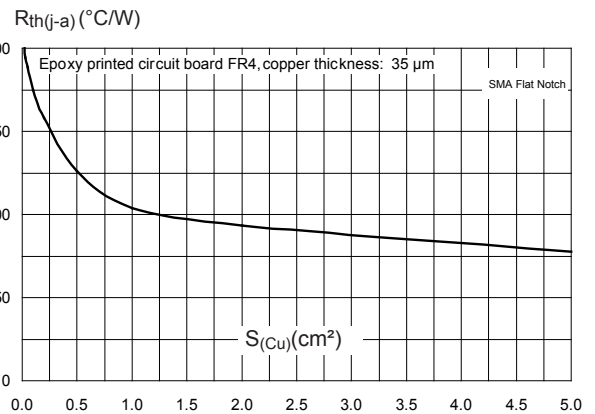

Figure 11. Thermal resistance junction to ambient versus copper surface under each lead (SMB)

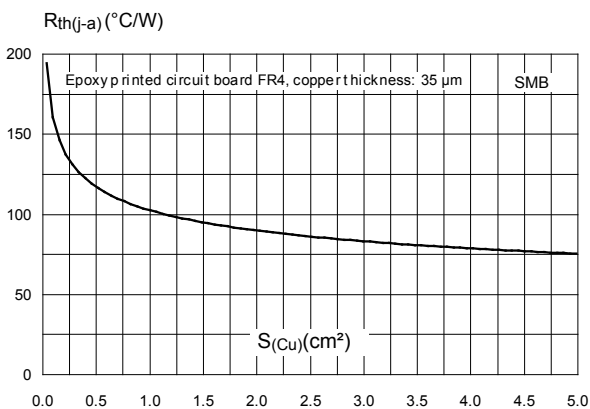

Figure 12. Thermal resistance junction to ambient versus copper surface under each lead (SMB flat)

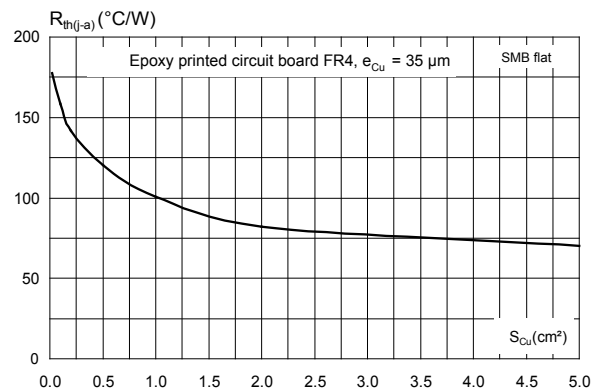
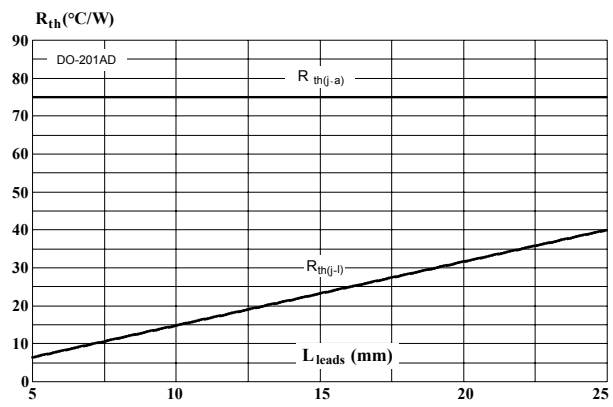

Figure 13. Thermal resistance versus lead length



2 Package information

In order to meet environmental requirements, ST offers these devices in different grades of **ECOPACK** packages, depending on their level of environmental compliance. ECOPACK specifications, grade definitions and product status are available at: www.st.com. ECOPACK is an ST trademark.

2.1 SMA Flat Notch package information

- Epoxy meets UL94, V0
- Cooling method: by conduction (C)
- Band indicates cathode

Figure 14. SMA Flat Notch package outline

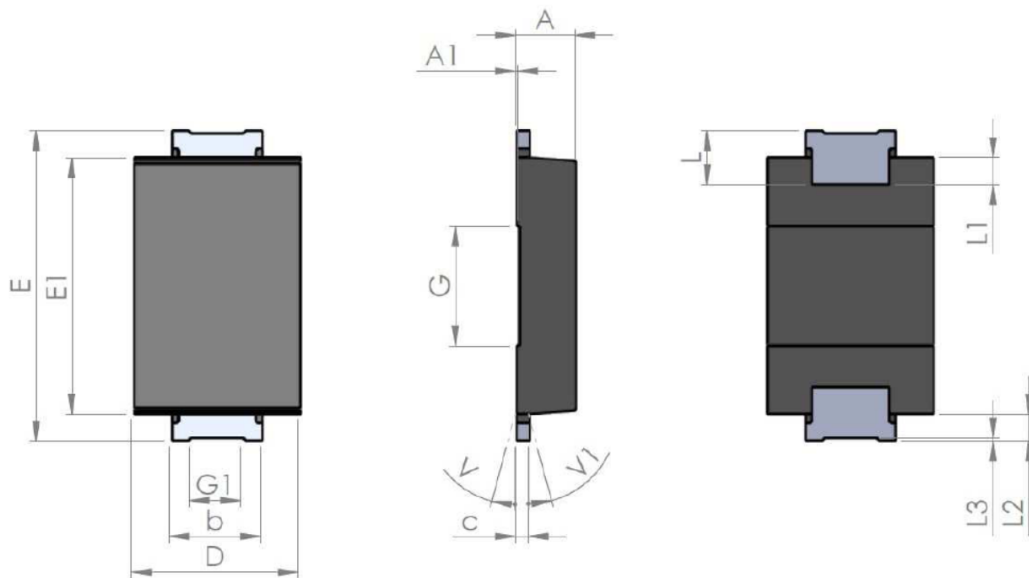
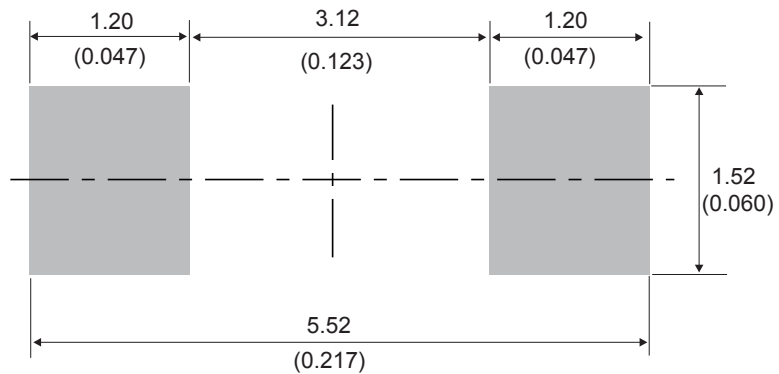

Table 4. SMA Flat Notch package mechanical data

Ref.	Dimensions					
	Millimeters			Inches (for reference only)		
	Min.	Typ.	Max.	Min.	Typ.	Max.
A1	0.90		1.10	0.035		0.044
A1		0.05			0.002	
b	1.25		1.65	0.049		0.065
C	0.15		0.40	0.005		0.016
D	2.25		2.90	0.088		0.115
E	5.00		5.35	0.196		0.211
E1	3.95		4.60	0.155		0.182
G		2.00			0.079	
G1		0.85			0.033	
L	0.75		1.20	0.029		
L1		0.45			0.018	
L2		0.45			0.018	
L3		0.05			0.002	
V			8°			8°
V1			8°			8°

Figure 15. SMA Flat Notch recommended footprint in mm (inches)



2.2 SMB package information

- Epoxy meets UL94, V0
- Lead-free package

Figure 16. SMB package outline

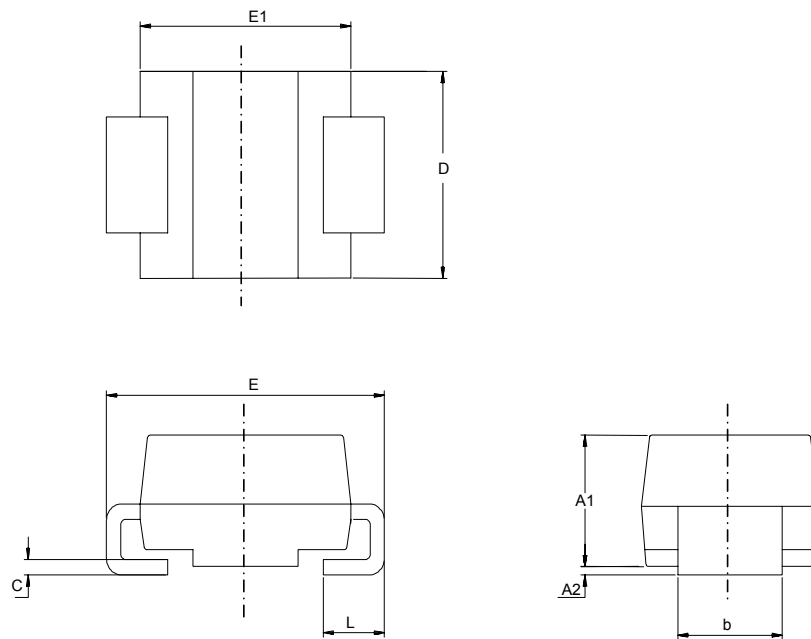
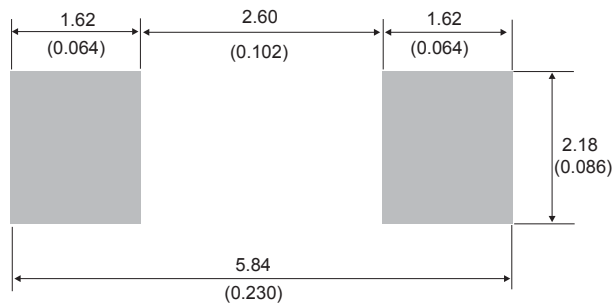

Table 5. SMB package mechanical data

Ref.	Dimensions			
	Millimeters		Inches (for reference only)	
	Min.	Max.	Min.	Max.
A1	1.90	2.45	0.074	0.097
A2	0.05	0.20	0.001	0.008
b	1.95	2.20	0.076	0.087
c	0.15	0.40	0.005	0.016
D	3.30	3.95	0.129	0.156
E	5.10	5.60	0.200	0.221
E1	4.05	4.60	0.159	0.182
L	0.75	1.50	0.029	0.060

Figure 17. SMB recommended footprint



2.3 SMB Flat package information

- Epoxy meets UL94, V0
- Lead-free package

Figure 18. SMB Flat package outline

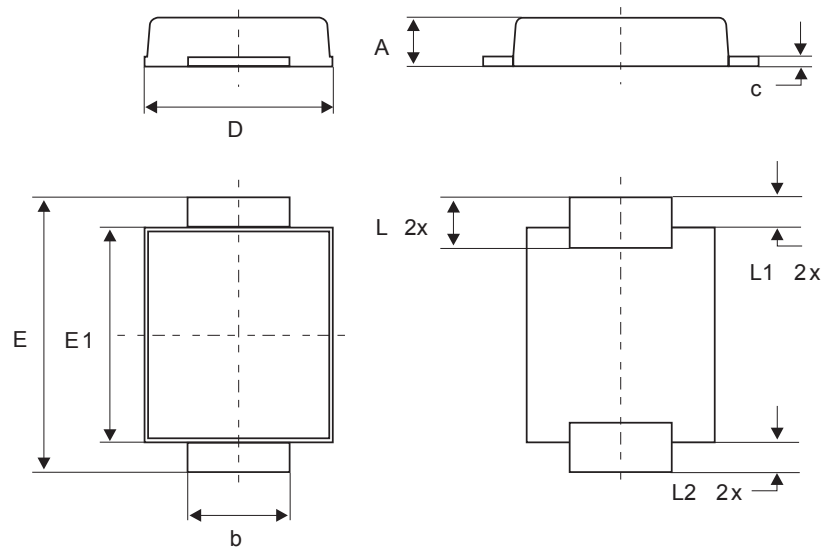
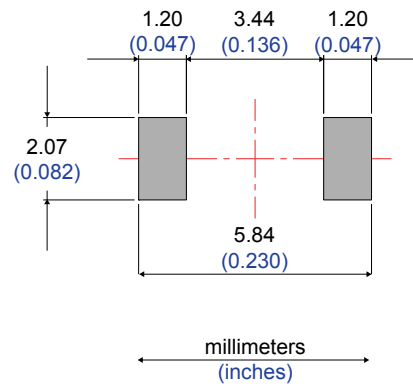

Table 6. SMB Flat mechanical data

Ref.	Dimensions					
	Millimeters			Inches		
	Min.	Typ.	Max.	Min.	Typ.	Max.
A	0.90		1.10	0.035		0.044
b	1.95		2.20	0.076		0.087
c	0.15		0.40	0.005		0.016
D	3.30		3.95	0.129		0.156
E	5.10		5.60	0.200		0.221
E1	4.05		4.60	0.159		0.182
L	0.75		1.50	0.029		0.060
L1		0.40			0.016	
L2		0.60			0.024	

Figure 19. Footprint recommendations, dimensions in mm (inches)



2.4 DO-201AD package information

- Epoxy meets UL 94, V0

Figure 20. DO-201AD package outline

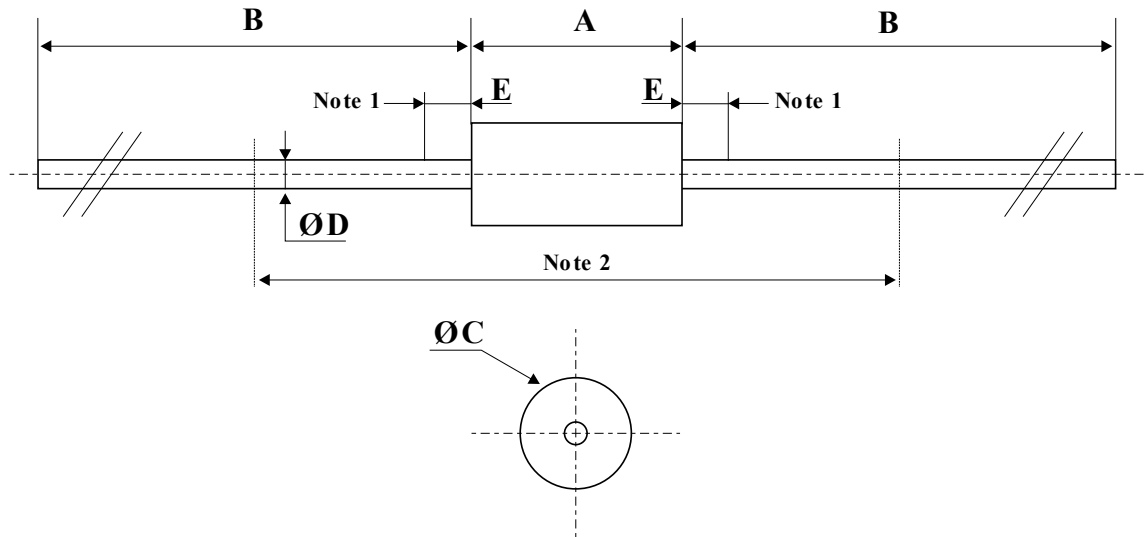

Table 7. DO-201AD package mechanical data

Ref.	Dimensions					
	Millimeters			Inches (for reference only)		
	Min.	Typ.	Max.	Min.	Typ.	Max.
A		-	9.50		-	0.374
B	25.40	-		1.000	-	
C		-	5.30		-	0.209
D ⁽¹⁾		-	1.30		-	0.051
E		-	1.25		-	0.049
Note 2 ⁽²⁾	15.00			0.590		

- The lead diameter D is not controlled over zone E
- The minimum length, which must stay straight between the right angles after bending, is 15 mm (0.59")

3 Ordering information

Table 8. Ordering information

Order code	Marking	Package	Weight	Base qty.	Delivery mode
STPS3150U	G315	SMB	0.107 g	2500	Tape and reel
STPS3150UF	FG315	SMB Flat	0.050 g	5000	Tape and reel
STPS3150	STPS3150	DO-201AD	1.120 g	600	Ammopack
STPS3150RL	STPS3150	DO-201AD	1.120 g	1900	Tape and reel
STPS3150AFN	A3150	SMA Flat Notch	0.039 g	10 000	Tape and reel

Revision history

Table 9. Document revision history

Date	Version	Changes
May-2003	2A	Last update.
31-May-2006	3	Reformatted to current standard. Added ECOPACK statement. Updated SMB footprint in Figure 12. Changed nF to pF in Figure 8.
8-Feb-2007	4	Added SMB flat and SMB flat e package.
20-Jul-2011	5	Updated Table 2.
11-Aug-2016	6	Updated Table 2 and all curves.
08-Oct-2019	7	Added Section 2.1 SMA Flat Notch package information .

IMPORTANT NOTICE – PLEASE READ CAREFULLY

STMicroelectronics NV and its subsidiaries (“ST”) reserve the right to make changes, corrections, enhancements, modifications, and improvements to ST products and/or to this document at any time without notice. Purchasers should obtain the latest relevant information on ST products before placing orders. ST products are sold pursuant to ST’s terms and conditions of sale in place at the time of order acknowledgement.

Purchasers are solely responsible for the choice, selection, and use of ST products and ST assumes no liability for application assistance or the design of Purchasers’ products.

No license, express or implied, to any intellectual property right is granted by ST herein.

Resale of ST products with provisions different from the information set forth herein shall void any warranty granted by ST for such product.

ST and the ST logo are trademarks of ST. For additional information about ST trademarks, please refer to www.st.com/trademarks. All other product or service names are the property of their respective owners.

Information in this document supersedes and replaces information previously supplied in any prior versions of this document.

© 2019 STMicroelectronics – All rights reserved