

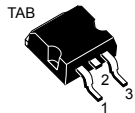
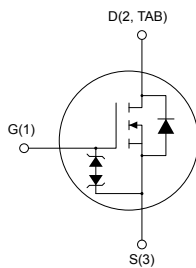

## Automotive-grade N-channel 650 V, 0.15 $\Omega$ typ., 20 A MDmesh M2 Power MOSFET in a D<sup>2</sup>PAK package

 D<sup>2</sup>PAK

AM01479V1

### Features

Order code	V <sub>DS</sub>	R <sub>DS(on)</sub> max.	I <sub>D</sub>
STB30N65M2AG	650 V	0.18 $\Omega$	20 A

- AEC-Q101 qualified 
- Extremely low gate charge
- Excellent output capacitance (C<sub>OSS</sub>) profile
- 100% avalanche tested
- Zener-protected

### Applications

- Switching applications

### Description

This device is an N-channel Power MOSFET developed using MDmesh M2 technology. Thanks to its strip layout and an improved vertical structure, the device exhibits low on-resistance and optimized switching characteristics, rendering it suitable for the most demanding high efficiency converters.



#### Product status link

[STB30N65M2AG](#)

#### Product summary

<b>Order code</b>	STB30N65M2AG
<b>Marking</b>	30N65M2
<b>Package</b>	D <sup>2</sup> PAK
<b>Packing</b>	Tape and reel

# 1 Electrical ratings

**Table 1. Absolute maximum ratings**

Symbol	Parameter	Value	Unit
$V_{GS}$	Gate-source voltage	$\pm 25$	V
$I_D$	Drain current (continuous) at $T_C = 25\text{ }^\circ\text{C}$	20	A
$I_D$	Drain current (continuous) at $T_C = 100\text{ }^\circ\text{C}$	13	A
$I_{DM}^{(1)}$	Drain current (pulsed)	55	A
$P_{TOT}$	Total power dissipation at $T_C = 25\text{ }^\circ\text{C}$	190	W
$I_{AR}$	Avalanche current, repetitive or not-repetitive (pulse width limited by $T_J$ max)	2.4	A
$E_{AS}$	Single pulse avalanche energy (starting $T_J = 25\text{ }^\circ\text{C}$ , $I_D = I_{AR}$ , $V_{DD} = 50\text{ V}$ )	760	mJ
$dv/dt^{(2)}$	Peak diode recovery voltage slope	15	V/ns
$dv/dt^{(3)}$	MOSFET $dv/dt$ ruggedness	50	V
$T_{stg}$	Storage temperature range	-55 to 150	$^\circ\text{C}$
$T_J$	Operating junction temperature range		$^\circ\text{C}$

1. Pulse width limited by safe operating area.
2.  $I_{SD} \leq 20\text{ A}$ ,  $di/dt \leq 400\text{ A}/\mu\text{s}$ ;  $V_{DS}$  peak  $< V_{(BR)DSS}$ ,  $V_{DD} = 520\text{ V}$ .
3.  $V_{DS} \leq 520\text{ V}$ .

**Table 2. Thermal data**

Symbol	Parameter	Value	Unit
$R_{thj-case}$	Thermal resistance junction-case	0.66	$^\circ\text{C}/\text{W}$
$R_{thj-pcb}^{(1)}$	Thermal resistance junction-pcb	30	$^\circ\text{C}/\text{W}$

1. When mounted on 1inch<sup>2</sup> FR-4 board, 2 oz Cu.

## 2 Electrical characteristics

( $T_C = 25\text{ °C}$  unless otherwise specified)

**Table 3. On /off states**

Symbol	Parameter	Test conditions	Min.	Typ.	Max.	Unit
$V_{(BR)DSS}$	Drain-source breakdown voltage	$V_{GS} = 0\text{ V}$ , $I_D = 1\text{ mA}$	650			V
$I_{DSS}$	Zero gate voltage drain current	$V_{GS} = 0\text{ V}$ , $V_{DS} = 650\text{ V}$			1	$\mu\text{A}$
		$V_{GS} = 0\text{ V}$ , $V_{DS} = 650\text{ V}$ , $T_C = 125\text{ °C}$ <sup>(1)</sup>			100	$\mu\text{A}$
$I_{GSS}$	Gate-body leakage current	$V_{GS} = \pm 25\text{ V}$ , $V_{DS} = 0\text{ V}$			$\pm 10$	$\mu\text{A}$
$V_{GS(th)}$	Gate threshold voltage	$V_{DS} = V_{GS}$ , $I_D = 250\text{ }\mu\text{A}$	2	3	4	V
$R_{DS(on)}$	Static drain-source on-resistance	$V_{GS} = 10\text{ V}$ , $I_D = 10\text{ A}$		0.15	0.18	$\Omega$

1. Defined by design, not subject to production test.

**Table 4. Dynamic**

Symbol	Parameter	Test conditions	Min.	Typ.	Max.	Unit
$C_{iss}$	Input capacitance	$V_{DS} = 100\text{ V}$ , $f = 1\text{ MHz}$ , $V_{GS} = 0\text{ V}$	-	1440	-	pF
$C_{oss}$	Output capacitance		-	60	-	pF
$C_{rss}$	Reverse transfer capacitance		-	0.5	-	pF
$C_{oss\ eq}$ <sup>(1)</sup>	Equivalent capacitance time related	$V_{DS} = 0\text{ to }520\text{ V}$ , $V_{GS} = 0\text{ V}$	-	307	-	pF
$R_G$	Intrinsic gate resistance	$f = 1\text{ MHz}$ open drain	-	4.9	-	$\Omega$
$Q_g$	Total gate charge	$V_{DD} = 520\text{ V}$ , $I_D = 20\text{ A}$ , $V_{GS} = 0\text{ to }10\text{ V}$ (see Figure 14. Test circuit for gate charge behavior)	-	30.8	-	nC
$Q_{gs}$	Gate-source charge		-	6.8	-	nC
$Q_{gd}$	Gate-drain charge		-	10.2	-	nC

1.  $C_{oss\ eq}$  is defined as a constant equivalent capacitance giving the same charging time as  $C_{oss}$  when  $V_{DS}$  increases from 0 to 80%  $V_{DSS}$

**Table 5. Switching times**

Symbol	Parameter	Test conditions	Min.	Typ.	Max.	Unit
$t_{d(on)}$	Turn-on delay time	$V_{DD} = 325\text{ V}$ , $I_D = 10\text{ A}$ , $R_G = 4.7\text{ }\Omega$ , $V_{GS} = 10\text{ V}$ (see Figure 13. Test circuit for resistive load switching times and Figure 18. Switching time waveform)	-	15	-	ns
$t_r$	Rise time		-	8	-	ns
$t_{d(off)}$	Turn-off delay time		-	58	-	ns
$t_f$	Fall time		-	10	-	ns

**Table 6. Source drain diode**

Symbol	Parameter	Test conditions	Min.	Typ.	Max.	Unit
$I_{SD}$	Source-drain current		-		20	A
$I_{SDM}^{(1)}$	Source-drain current (pulsed)		-		55	A
$V_{SD}^{(2)}$	Forward on voltage	$I_{SD} = 20\text{ A}, V_{GS} = 0\text{ V}$	-		1.6	V
$t_{rr}$	Reverse recovery time	$I_{SD} = 20\text{ A}, di/dt = 100\text{ A}/\mu\text{s}, V_{DD} = 60\text{ V}$ (see Figure 15. Test circuit for inductive load switching and diode recovery times)	-	250		ns
$Q_{rr}$	Reverse recovery charge		-	2.0		$\mu\text{C}$
$I_{RRM}$	Reverse recovery current		-	16		A
$t_{rr}$	Reverse recovery time	$I_{SD} = 20\text{ A}, di/dt = 100\text{ A}/\mu\text{s},$ $V_{DD} = 60\text{ V}, T_J = 150\text{ }^\circ\text{C}$ (see Figure 15. Test circuit for inductive load switching and diode recovery times)	-	380		ns
$Q_{rr}$	Reverse recovery charge		-	3.3		$\mu\text{C}$
$I_{RRM}$	Reverse recovery current		-	18		A

1. Pulse width limited by safe operating area.

2. Pulsed: pulse duration = 300  $\mu\text{s}$ , duty cycle 1.5 %.

## 2.1 Electrical characteristics (curves)

**Figure 1. Safe operating area**

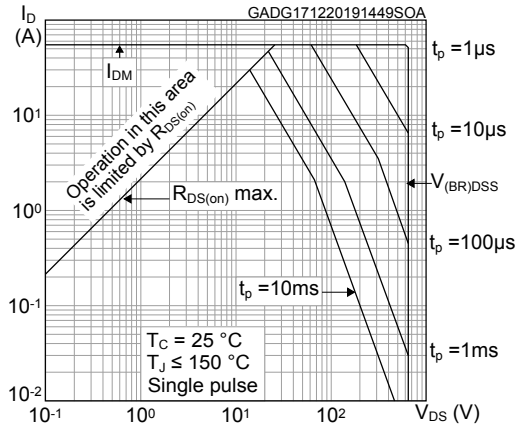

**Figure 2. Maximum transient thermal impedance**

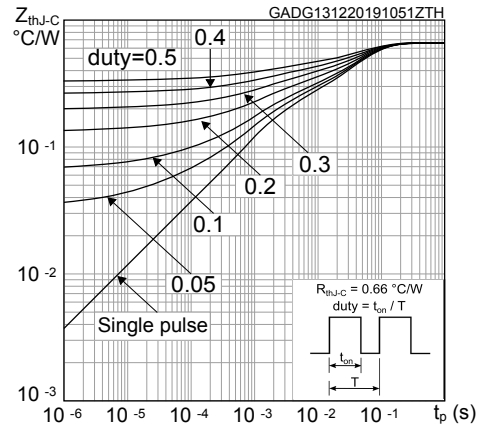

**Figure 3. Typical output characteristics**

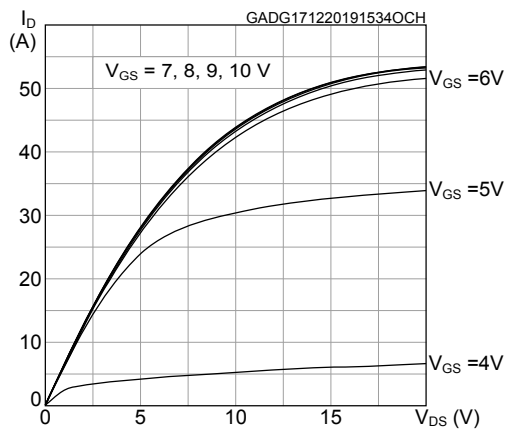

**Figure 4. Typical output characteristics**

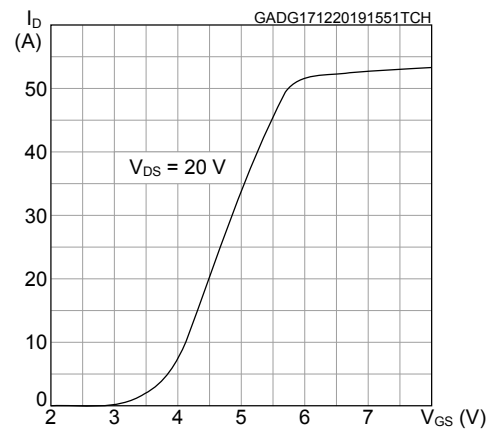

**Figure 5. Typical gate charge characteristics**

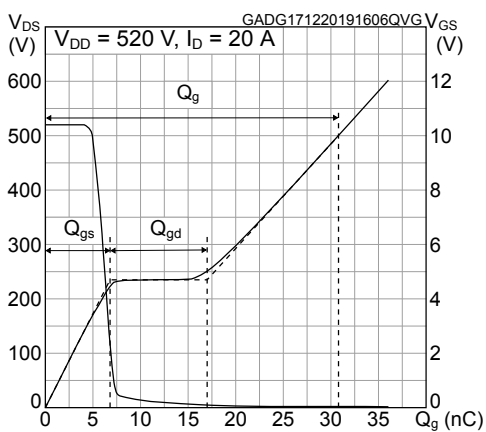

**Figure 6. Typical drain-source on-resistance**

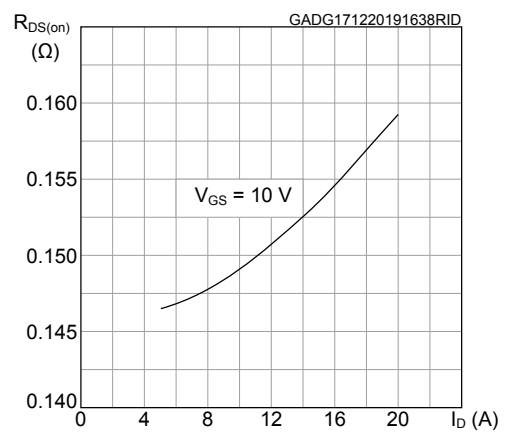

**Figure 7. Typical capacitance characteristics**

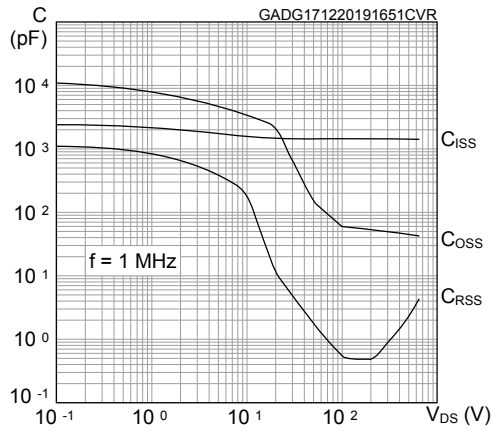

**Figure 8. Typical output capacitance stored energy**

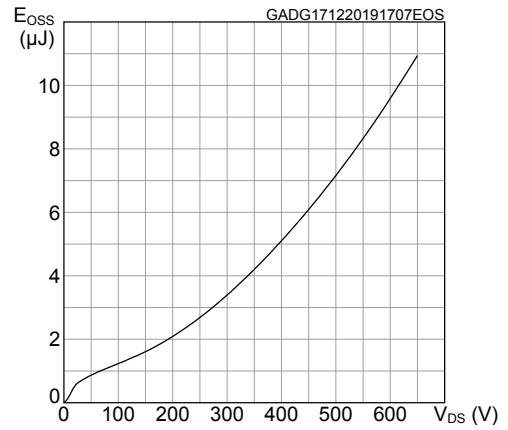

**Figure 9. Normalized gate threshold vs temperature**

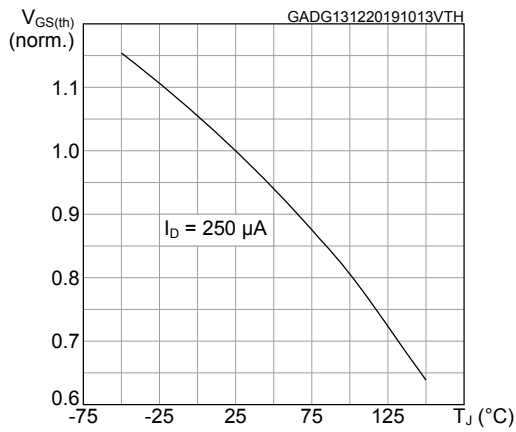

**Figure 10. Normalized on-resistance vs temperature**

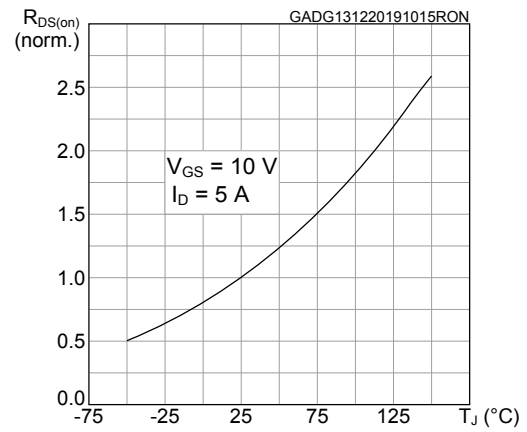

**Figure 11. Normalized breakdown voltage vs temperature**

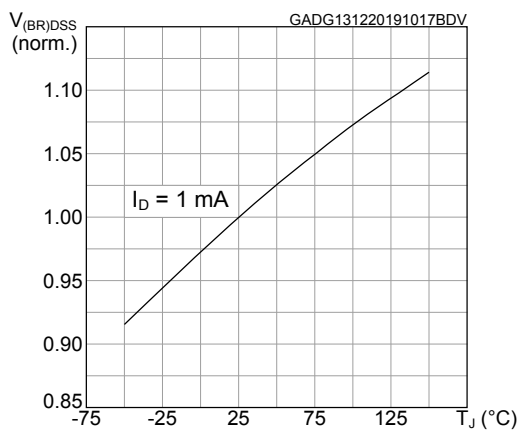

**Figure 12. Typical reverse diode forward characteristics**

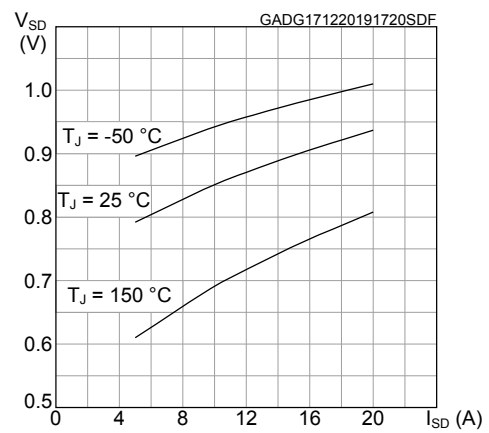

### 3 Test circuits

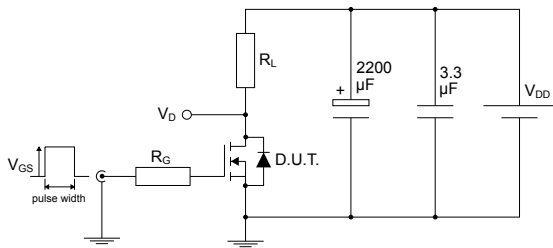
**Figure 13. Test circuit for resistive load switching times**

AM01468v1

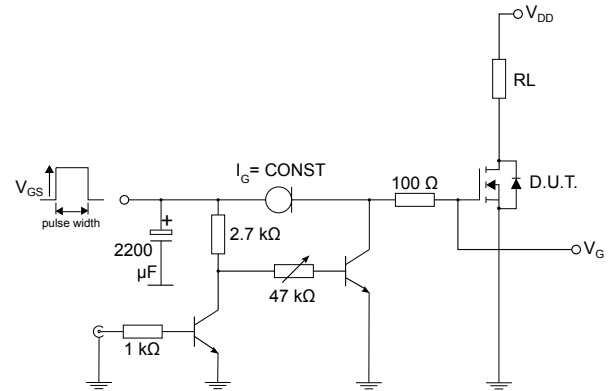
**Figure 14. Test circuit for gate charge behavior**

AM01469v10

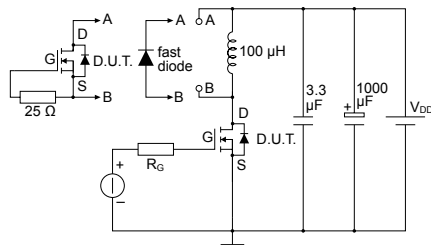
**Figure 15. Test circuit for inductive load switching and diode recovery times**

AM01470v1

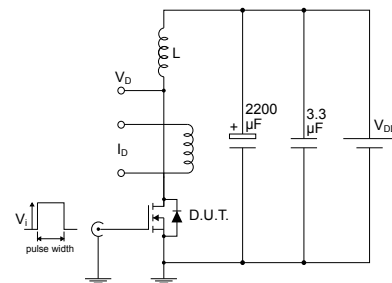
**Figure 16. Unclamped inductive load test circuit**

AM01471v1

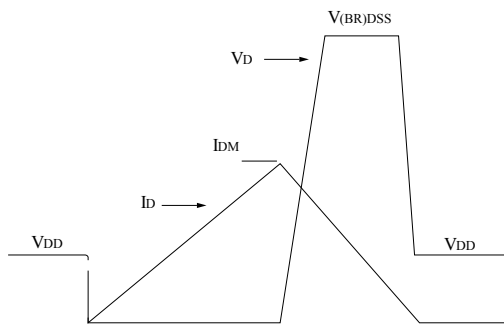
**Figure 17. Unclamped inductive waveform**

AM01472v1

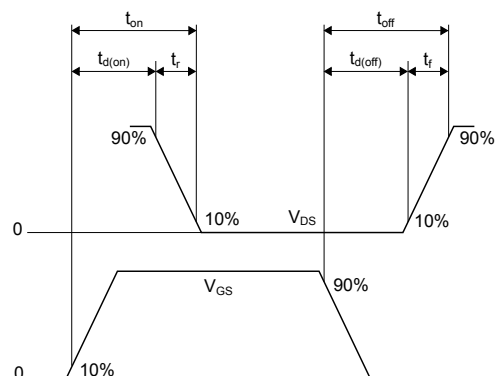
**Figure 18. Switching time waveform**

AM01473v1

## 4 Package information

In order to meet environmental requirements, ST offers these devices in different grades of **ECOPACK** packages, depending on their level of environmental compliance. ECOPACK specifications, grade definitions and product status are available at: [www.st.com](http://www.st.com). ECOPACK is an ST trademark.

### 4.1 D<sup>2</sup>PAK (TO-263) type A package information

Figure 19. D<sup>2</sup>PAK (TO-263) type A package outline

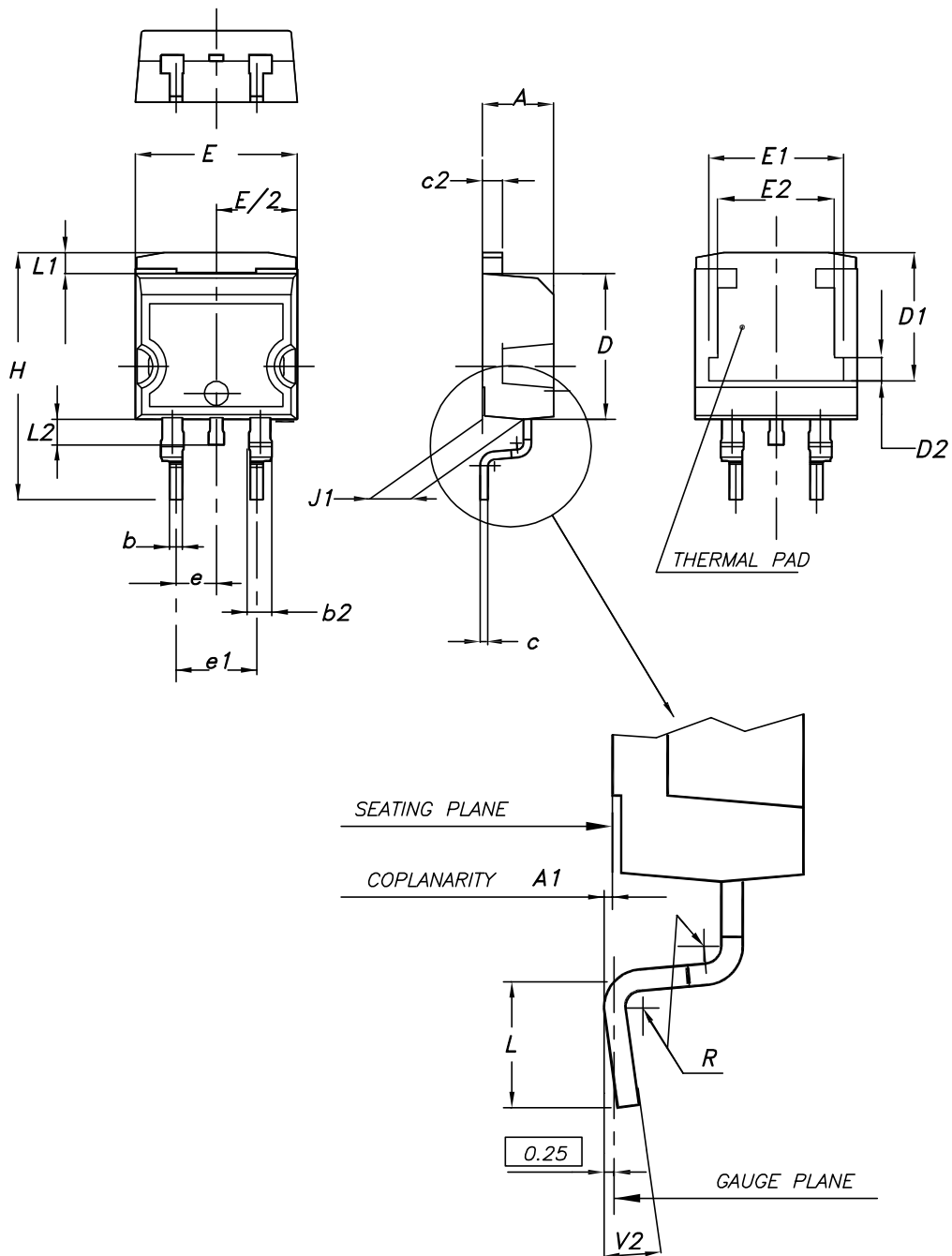

0079457\_26



**Table 7. D<sup>2</sup>PAK (TO-263) type A package mechanical data**

Dim.	mm		
	Min.	Typ.	Max.
A	4.40		4.60
A1	0.03		0.23
b	0.70		0.93
b2	1.14		1.70
c	0.45		0.60
c2	1.23		1.36
D	8.95		9.35
D1	7.50	7.75	8.00
D2	1.10	1.30	1.50
E	10.00		10.40
E1	8.30	8.50	8.70
E2	6.85	7.05	7.25
e		2.54	
e1	4.88		5.28
H	15.00		15.85
J1	2.49		2.69
L	2.29		2.79
L1	1.27		1.40
L2	1.30		1.75
R		0.40	
V2	0°		8°

Figure 20. D<sup>2</sup>PAK (TO-263) recommended footprint (dimensions are in mm)

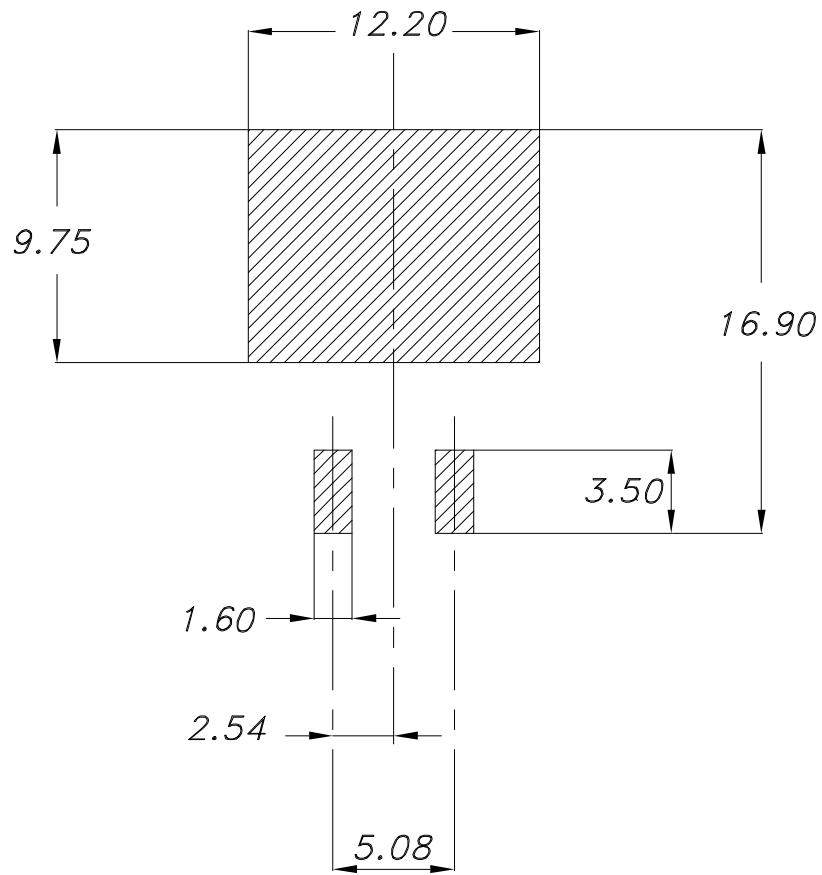

Footprint\_26

## 4.2 D<sup>2</sup>PAK packing information

**Figure 21. D<sup>2</sup>PAK tape outline**

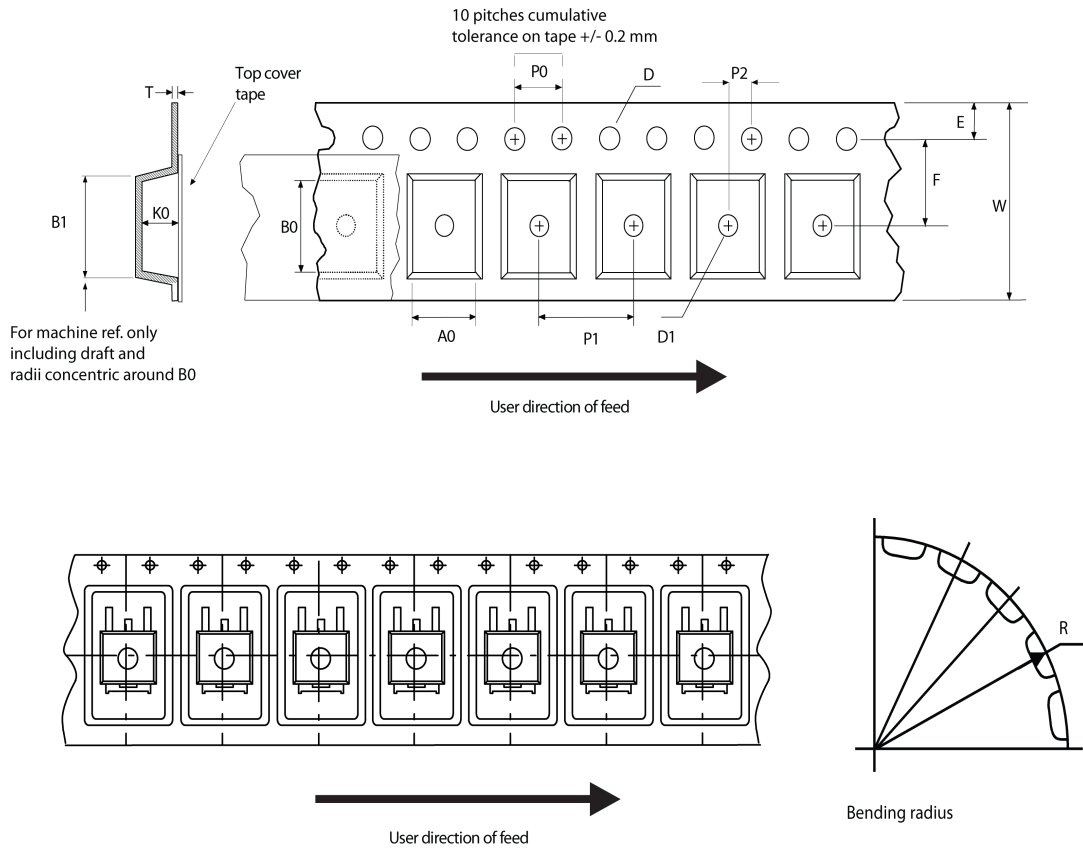

AM08852v1

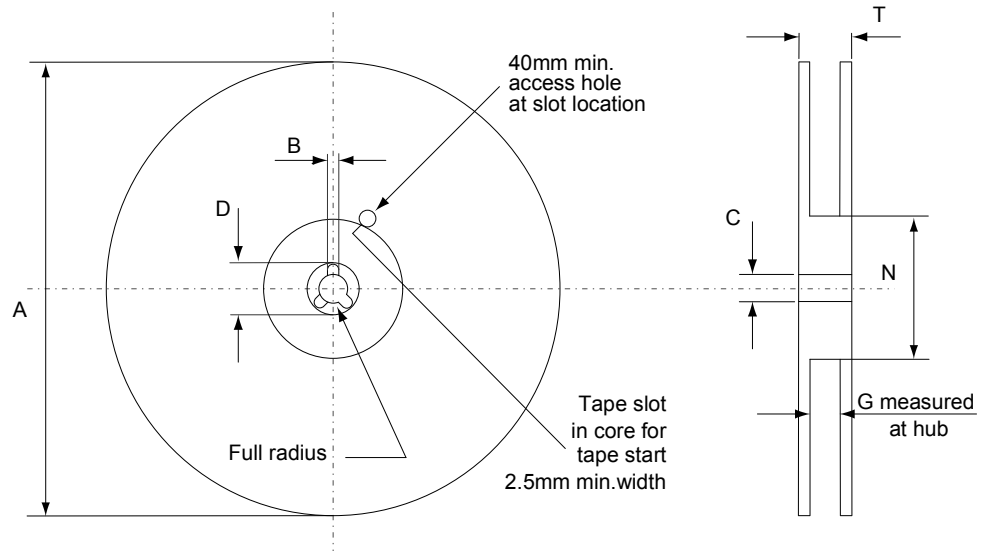
**Figure 22. D<sup>2</sup>PAK reel outline**

AM06038v1

**Table 8. D<sup>2</sup>PAK tape and reel mechanical data**

Tape			Reel		
Dim.	mm		Dim.	mm	
	Min.	Max.		Min.	Max.
A0	10.5	10.7	A		330
B0	15.7	15.9	B	1.5	
D	1.5	1.6	C	12.8	13.2
D1	1.59	1.61	D	20.2	
E	1.65	1.85	G	24.4	26.4
F	11.4	11.6	N	100	
K0	4.8	5.0	T		30.4
P0	3.9	4.1			
P1	11.9	12.1	Base quantity		1000
P2	1.9	2.1	Bulk quantity		1000
R	50				
T	0.25	0.35			
W	23.7	24.3			

## Revision history

**Table 9. Document revision history**

Date	Revision	Changes
05-Sep-2017	1	First release
18-Dec-2019	2	Updated <a href="#">Section 1</a> Electrical ratings. Updated <a href="#">Section 2</a> Electrical characteristics. Updated <a href="#">Section 2.1</a> Electrical characteristics (curves). Minor text changes.

## Contents

<b>1</b>	<b>Electrical ratings</b> .....	<b>2</b>
<b>2</b>	<b>Electrical characteristics</b> .....	<b>3</b>
<b>2.1</b>	Electrical characteristics (curves) .....	<b>5</b>
<b>3</b>	<b>Test circuits</b> .....	<b>7</b>
<b>4</b>	<b>Package information</b> .....	<b>8</b>
<b>4.1</b>	D <sup>2</sup> PAK (TO-263) type A package information .....	<b>8</b>
<b>4.2</b>	D <sup>2</sup> PAK type A packing information .....	<b>10</b>
	<b>Revision history</b> .....	<b>13</b>

**IMPORTANT NOTICE – PLEASE READ CAREFULLY**

STMicroelectronics NV and its subsidiaries (“ST”) reserve the right to make changes, corrections, enhancements, modifications, and improvements to ST products and/or to this document at any time without notice. Purchasers should obtain the latest relevant information on ST products before placing orders. ST products are sold pursuant to ST’s terms and conditions of sale in place at the time of order acknowledgement.

Purchasers are solely responsible for the choice, selection, and use of ST products and ST assumes no liability for application assistance or the design of Purchasers’ products.

No license, express or implied, to any intellectual property right is granted by ST herein.

Resale of ST products with provisions different from the information set forth herein shall void any warranty granted by ST for such product.

ST and the ST logo are trademarks of ST. For additional information about ST trademarks, please refer to [www.st.com/trademarks](http://www.st.com/trademarks). All other product or service names are the property of their respective owners.

Information in this document supersedes and replaces information previously supplied in any prior versions of this document.

© 2019 STMicroelectronics – All rights reserved