

## 13.56 MHz short-range contactless memory chip with 512-bit EEPROM and anticollision functions

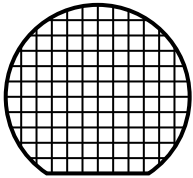

-Unsawn wafer  
-Bumped and sawn wafer

### Product status link

[ST25TB512-AT](#)

### Features

- ISO 14443-2 Type B air interface compliant
- ISO 14443-3 Type B frame format compliant
- 13.56 MHz carrier frequency
- 847 kHz subcarrier frequency
- 106 Kbit/second data transfer
- 8 bit Chip\_ID based anticollision system
- 2 count-down binary counters with automated anti-tearing protection
- 64-bit Unique Identifier
- 512-bit EEPROM with write protect feature
- Read\_block and Write\_block (32 bits)
- Internal tuning capacitor: 68 pF
- 1 million erase/write cycles
- 40-year data retention
- Self-timed programming cycle
- 5 ms typical programming time

### Application

- Transport

# 1 Description

The **ST25TB512-AT** is a contactless memory, powered by an externally transmitted radio wave. It contains a 512-bit user EEPROM. The memory is organized as 128 blocks of 32 bits. The **ST25TB512-AT** is accessed via the 13.56 MHz carrier. Incoming data are demodulated and decoded from the received amplitude shift keying (ASK) modulation signal and outgoing data are generated by load variation using bit phase shift keying (BPSK) coding of a 847 kHz sub-carrier. The received ASK wave is 10% modulated. The data transfer rate between the **ST25TB512-AT** and the reader is 106 kbit/s in both reception and emission modes.

The **ST25TB512-AT** follows the ISO 14443 - 2 Type B recommendation for the radio-frequency power and signal interface.

**Figure 1. Logic diagram**

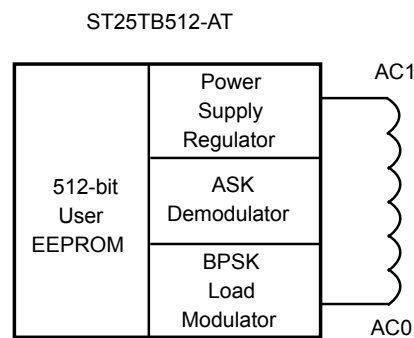

The **ST25TB512-AT** is specifically designed for short range applications that need re-usable products. The **ST25TB512-AT** includes an anticollision mechanism that allows it to detect and select tags present at the same time within range of the reader. The anticollision is based on a probabilistic scanning method using slot markers.

**Table 1. Signal names**

Signal names	Description
AC1	Antenna coil
AC0	Antenna coil

The **ST25TB512-AT** contact-less EEPROM can be randomly read and written in block mode (each block containing 32 bits). The instruction set includes the following nine commands:

- Read\_block
- Write\_block
- Initiate
- Pcall16
- Slot\_marker
- Select
- Completion
- Reset\_to\_inventory
- Get\_UID

The **ST25TB512-AT** memory is organized in three areas, as described in Table 1. The first area is a resettable OTP (one time programmable) area in which bits can only be switched from 1 to 0. Using a special command, it is possible to erase all bits of this area to 1. The second area provides two 32-bit binary counters which can only be decremented. The last area is the EEPROM memory. It is accessible by block of 32 bits and includes an auto-erase cycle during each Write\_block command.

Die floor plan and physical options related to the die assembly are described in Figure 2.

Figure 2. Die floor plan and assembly options

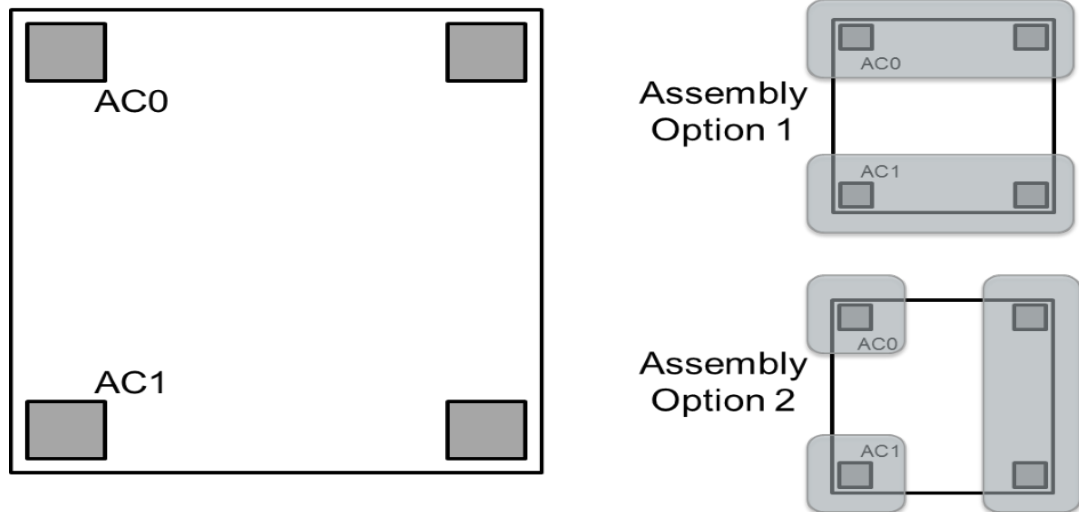

For the option 1 of the die assembly, the CTUN (referenced in Table 2) can increase from 0.5pF to 1pF. The option 2 of the die assembly is showing a tripod which can be used for physical stability, having no impact on CTUN parameter.

## **2**      **Signal description**

---

### **2.1**      **AC1, AC0**

The pads for the Antenna Coil. AC1 and AC0 must be directly bonded to the antenna.

### 3 Data transfer

#### 3.1 Input data transfer from reader to ST25TB512-AT (request frame)

The reader must generate a 13.56 MHz sinusoidal carrier frequency at its antenna, with enough energy to “remote-power” the memory. The energy received at the ST25TB512-AT’s antenna is transformed into a supply voltage by a regulator, and into data bits by the ASK demodulator. For the ST25TB512-AT to decode correctly the information it receives, the reader must 10% amplitude-modulate the 13.56 MHz wave before sending it to the ST25TB512-AT. This is represented in Figure 3. The data transfer rate is 106 Kbits/s.

In some figures of this datasheet the ST25TBxxx refers to ST25TB512-AT.

**Figure 3. ST25TB512-AT 10% ASK modulation of the received wave**

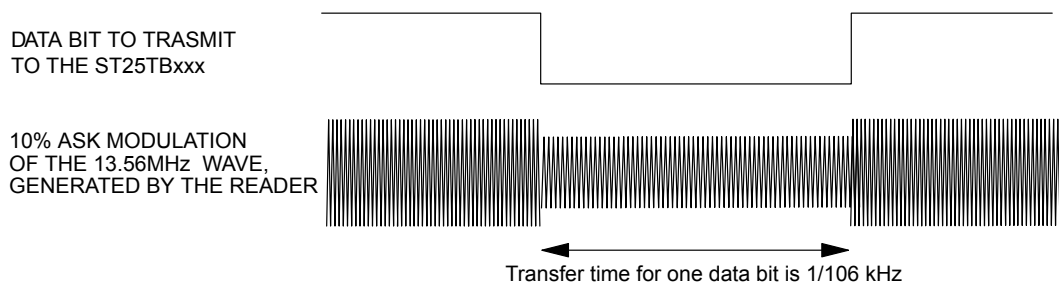

##### 3.1.1 Character transmission format for request frame

The ST25TB512-AT transmits and receives data bytes as 10-bit characters, with the least significant bit ( $b_0$ ) transmitted first, as shown in Figure 4. Each bit duration, an ETU (elementary time unit), is equal to 9.44  $\mu$ s (1/106 kHz).

These characters, framed by a start of frame (SOF) and an end of frame (EOF), are put together to form a command frame as shown in Figure 10. A frame includes an SOF, commands, addresses, data, a CRC and an EOF as defined in the ISO 14443-3 Type B Standard. If an error is detected during data transfer, the ST25TB512-AT does not execute the command, but it does not generate an error frame.

**Figure 4. ST25TB512-AT request frame character format**

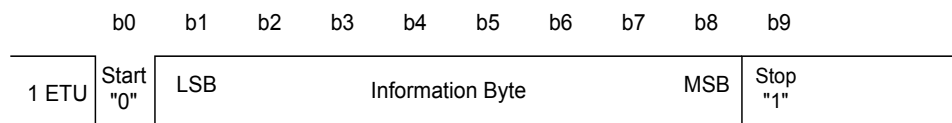

**Table 2. Bit description**

Bit	Description	Value
$b_0$	Start bit used to synchronize the transmission	$b_0 = 0$
$b_1$ to $b_8$	Information byte (command, address or data)	The information byte is sent with the least significant bit first
$b_9$	Stop bit used to indicate the end of a character	$b_9 = 1$

##### 3.1.2 Request start of frame

The SOF described in Figure 5 is composed of:

- one falling edge,

- followed by 10 ETUs at logic-0,
- followed by a single rising edge,
- followed by at least 2 ETUs (and at most 3) at logic-1.

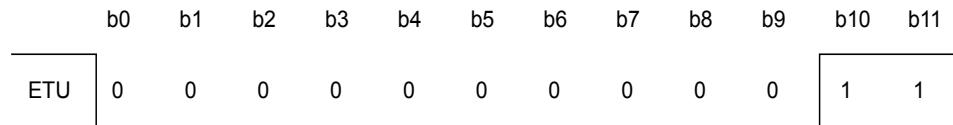
**Figure 5. Request start of frame**

### 3.1.3 Request end of frame

The EOF shown in Figure 6 is composed of:

- one falling edge,
- followed by 10 ETUs at logic-0,
- followed by a single rising edge.

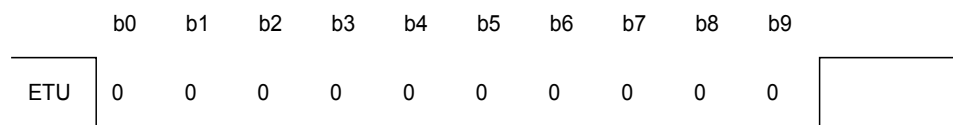
**Figure 6. Request end of frame**

### 3.2 Output data transfer from to reader ST25TB512-AT (answer frame)

The data bits issued by the ST25TB512-AT use back-scattering. Back-scattering is obtained by modifying the ST25TB512-AT current consumption at the antenna (load modulation). The load modulation causes a variation at the reader antenna by inductive coupling. With appropriate detector circuitry, the reader is able to pick up information from the ST25TB512-AT. To improve load-modulation detection, data is transmitted using a BPSK encoded, 847 kHz subcarrier frequency  $f_s$  as shown in Figure 7, and as specified in the ISO 14443-2 Type B standard.

**Figure 7. Wave transmitted using BPSK subcarrier modulation**

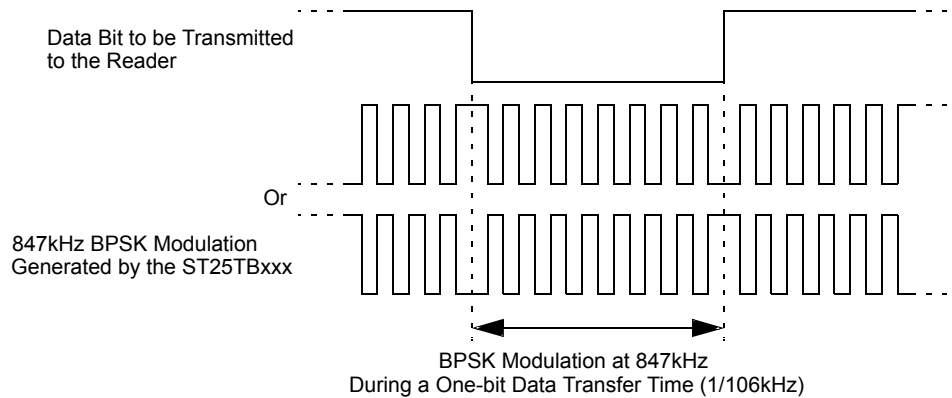

#### 3.2.1 Character transmission format for answer frame

The character format is the same as for input data transfer (Figure 4). The transmitted frames are made up of an SOF, data, a CRC and an EOF (Figure 10). As with an input data transfer, if an error occurs, the reader does not issue an error code to the ST25TB512-AT, but it should be able to detect it and manage the situation. The data transfer rate is 106 Kbits/second.

#### 3.2.2 Answer start of frame

The SOF described in Figure 8. Answer start of frame is composed of:

- followed by 10 ETUs at logic-0
- followed by 2 ETUs at logic-1

**Figure 8. Answer start of frame**

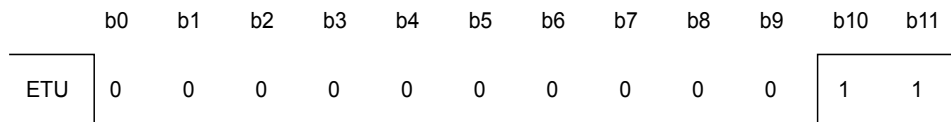

### 3.2.3 Answer end of frame

The EOF shown in Figure 9. Answer end of frame is composed of:

- followed by 10 ETUs at logic-0,
- followed by 2 ETUs at logic-1.

Figure 9. Answer end of frame

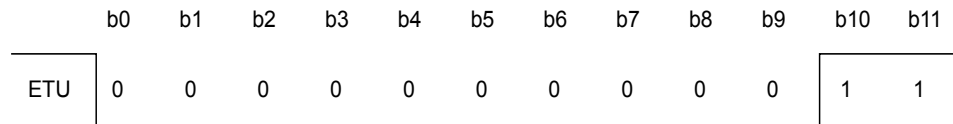

### 3.3 Transmission frame

Between the request data transfer and the answer data transfer, all ASK and BPSK modulations are suspended for a minimum time of  $t_0 = 128/f_S$ . This delay allows the reader to switch from Transmission to Reception mode. It is repeated after each frame. After  $t_0$ , the 13.56 MHz carrier frequency is modulated by the ST25TB512-AT at 847 kHz for a period of  $t_1 = 128/f_S$  to allow the reader to synchronize. After  $t_1$ , the first phase transition generated by the ST25TB512-AT forms the start bit ('0') of the answer SOF. After the falling edge of the answer EOF, the reader waits a minimum time,  $t_2$ , before sending a new request frame to the ST25TB512-AT.

Figure 10. Example of a complete transmission frame

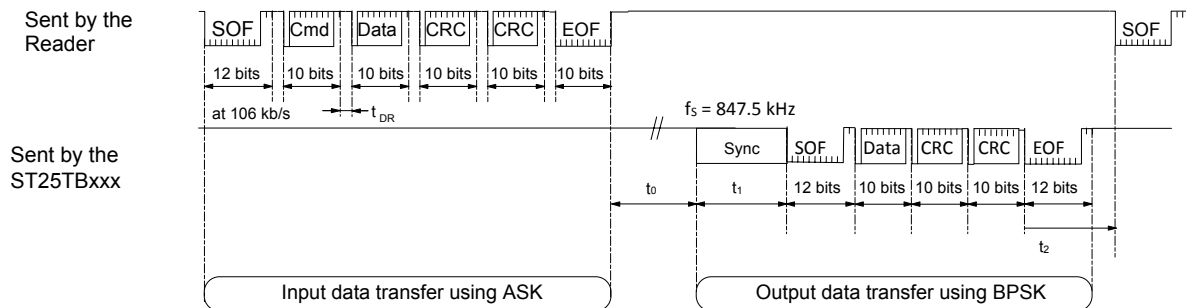



### 3.4 CRC

The 16-bit CRC used by the ST25TB512-AT is generated in compliance with the ISO14443 Type B recommendation. For further information, please see Appendix A ISO-14443 Type B CRC calculation. The initial register contents are all 1s: FFFFh.

The two-byte CRC is present in every request and in every answer frame, before the EOF. The CRC is calculated on all the bytes between SOF (not included) and the CRC field.

Upon reception of a request from a reader, the ST25TB512-AT verifies that the CRC value is valid. If it is invalid, the ST25TB512-AT discards the frame and does not answer the reader.

Upon reception of an answer from the ST25TB512-AT, the reader should verify the validity of the CRC. In case of error, the actions to be taken are the reader designer's responsibility.

The CRC is transmitted with the least significant byte first and each byte is transmitted with the least significant bit first.

Figure 11. CRC transmission rules

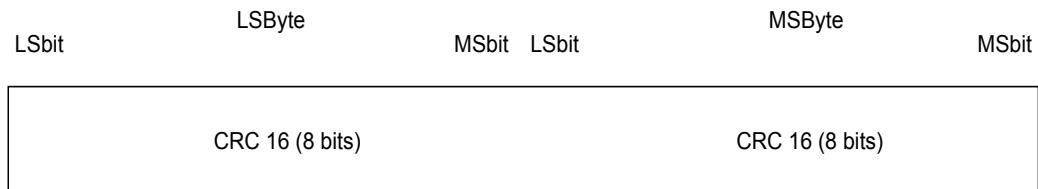

## 4 Memory mapping

The ST25TB512-AT is organized as 16 blocks of 32 bits as shown in Table 3. All blocks are accessible by the Read\_block command. Depending on the write access, they can be updated by the Write\_block command. A Write\_block updates all the 32 bits of the block.

**Table 3. ST25TB512-AT memory mapping**

Block Address	MSB	32-bit block			LSB	Description	
	b31	b24 b23	b16	b15	b8 b7		b0
0	User area					Lockable EEPROM	
1	User area						
2	User area						
3	User area						
4	User area						
5	32 bits binary counter					Count down counter	
6	32 bits binary counter						
7	User area					Lockable EEPROM	
8	User area						
9	User area						
10	User area						
11	User area						
12	User area						
13	User area						
14	User area						
15	User area						
255	OTP_Lock_Reg			1	ST Reserved		System OTP bits
UID0	64 bits UID area					ROM	
UID1							

## 4.1 EEPROM area

### 4.1.1 Block 0-4

Blocks 0 to 4 define a User area. They behave as standard EEPROM blocks, like blocks 7 to 15 as described in Table 4. Each block can be individually write-protected using the OTP\_Lock\_Reg bits of the system area. Once a block has been protected, it can no longer be unprotected.

**Table 4. Lockable EEPROM area (addresses 0 to 4)**

Block Address	MSB		32-bit block		LSB	Description
	b31	b24 b23	b16 b15	b8 b7	b0	
0						Lockable EEPROM
1						
2						
3						
4						

### 4.1.2 block 7-15

The 9 blocks between addresses 7 and 15 are EEPROM blocks of 32 bits each (36 bytes in total). (See not found for a map of the area.) These blocks can be accessed using the Read\_block and Write\_block commands. The Write\_block command for the EEPROM area always includes an auto-erase cycle prior to the write cycle.

Blocks 7 to 15 can be write-protected. Write access is controlled by the 9 bits of the OTP\_Lock\_Reg located at block address 255 (see OTP\_Lock\_Reg for details). Once protected, these blocks (7 to 15) cannot be unprotected.

**Table 5. EEPROM area (addresses 7 to 15)**

Block Address	MSB		32-bit block		LSB	Description
	b31	b24 b23	b16 b15	b8 b7	b0	
7						Lockable EEPROM
8						
9						
10						
11						
12						
13						
14						
15						

## 4.2 32-bit binary counters

The two 32-bit binary counters are located at block addresses 5 and 6. The ST25TB512-AT uses dedicated logic that only allows the update of a counter if the new value is lower than the previous one. This feature allows the application to count down by steps of 1 or more. The initial value in Counter 5 is FFFF FFFEh and is FFFF FFFFh in Counter 6. When the reached value is 0000 0000h, the counter is empty and cannot be reloaded. For each counter 5 and 6, the update is done by issuing the Write\_block command. The Write\_block command writes the new 32-bit value to the counter block address. Table 6 shows examples of how the counters operate.

The counter programming cycles are protected by automated antitearing logic. This function allows the counter value to be protected in case of power down within the programming cycle. In case of power down, the counter value is not updated and the previous value continues to be stored.

Blocks 5 and 6 can be write-protected using the OTP\_Lock\_Reg bits (block 255). Once a block has been protected, its contents cannot be modified. A protected counter block behaves like a ROM block.

Table 6. Binary counter (addresses 5 to 6)

Block Address	MSB	32-bit block				LSB	Description
	b31	b24 b23	b16 b15	b8 b7	b0		
5	32-bit Boolean area					Count down counter	
6	32-bit Boolean area						

Figure 12. Countdown example (binary format)

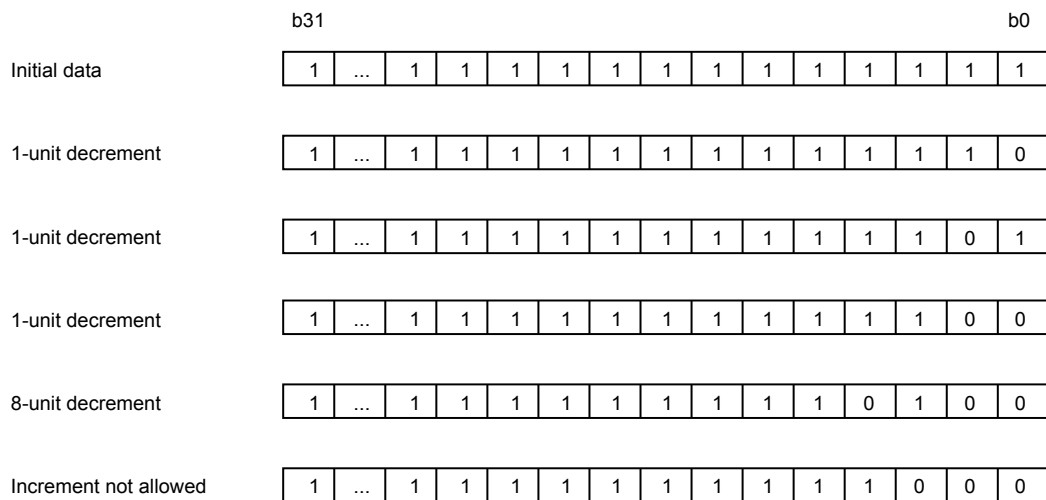

### 4.3 System area

This area is used to modify the settings of the ST25TB512-AT. It contains 2 registers: OTP\_Lock\_Reg and ST Reserved. See Table 7 for a map of this area.

A Write\_block command in this area will not erase the previous contents. Selected bits can thus be set from 1 to 0. All bits previously at 0 remain unchanged. Once all the 32 bits of a block are at 0, the block is empty and cannot be updated any more.

**Table 7. System area**

Block Address	MSB	32-bit block						LSB	Description
	b31	b24	b23	b16	b15	b14	b7	b0	
255	OTP_Lock_Reg			1	ST reserved			OTP	

#### 4.3.1 OTP\_Lock\_Reg

The 16 bits, b<sub>31</sub> to b<sub>16</sub>, of the System area (block address 255) are used as OTP\_Lock\_Reg bits in the ST25TB512-AT. They control the write access to the 16 EEPROM blocks with addresses 0 to 15 as follows:

- When b<sub>16</sub> is at 0, blocks 0 is write-protected
- When b<sub>17</sub> is at 0, block 1 is write-protected
- When b<sub>18</sub> is at 0, block 2 is write-protected
- When b<sub>19</sub> is at 0, block 3 is write-protected
- When b<sub>20</sub> is at 0, block 4 is write-protected
- When b<sub>21</sub> is at 0, block 5 is write-protected
- When b<sub>22</sub> is at 0, block 6 is write-protected
- When b<sub>23</sub> is at 0, block 7 is write-protected.
- When b<sub>24</sub> is at 0, blocks 8 is write-protected
- When b<sub>25</sub> is at 0, block 9 is write-protected
- When b<sub>26</sub> is at 0, block 10 is write-protected
- When b<sub>27</sub> is at 0, block 11 is write-protected
- When b<sub>29</sub> is at 0, block 12 is write-protected
- When b<sub>29</sub> is at 0, block 13 is write-protected
- When b<sub>30</sub> is at 0, block 14 is write-protected
- When b<sub>31</sub> is at 0, block 15 is write-protected.

The OTP\_Lock\_Reg bits cannot be erased. Once write-protected, EEPROM blocks behave like ROM blocks and cannot be unprotected.

After any modification of the OTP\_Lock\_Reg bits, it is necessary to send a Select command with a valid Chip\_ID to the ST25TB512-AT in order to load the block write protection into the logic.

---

## 5 ST25TB512-AT operation

---

All commands, data and CRC are transmitted to the **ST25TB512-AT** as 10-bit characters using ASK modulation. The start bit of the 10 bits,  $b_0$ , is sent first. The command frame received by the **ST25TB512-AT** at the antenna is demodulated by the 10% ASK demodulator, and decoded by the internal logic. Prior to any operation, the **ST25TB512-AT** must have been selected by a Select command. Each frame transmitted to the **ST25TB512-AT** must start with a start of frame, followed by one or more data characters, two CRC bytes and the final end of frame. When an invalid frame is decoded by the **ST25TB512-AT** (wrong command or CRC error), the memory does not return any error code.

When a valid frame is received, the **ST25TB512-AT** may have to return data to the reader. In this case, data is returned using BPSK encoding, in the form of 10-bit characters framed by an SOF and an EOF. The transfer is ended by the **ST25TB512-AT** sending the 2 CRC bytes and the EOF.

## 6 ST25TB512-AT states

The ST25TB512-AT can be switched into different states. Depending on the current state of the ST25TB512-AT, its logic will only answer to specific commands. These states are mainly used during the anticollision sequence, to identify and to access the ST25TB512-AT in a very short time. The ST25TB512-AT provides 6 different states, as described in the following paragraphs and in Figure 13.

### 6.1 Power-off state

The ST25TB512-AT is in Power-off state when the electromagnetic field around the tag is not strong enough. In this state, the ST25TB512-AT does not respond to any command.

### 6.2 Ready state

When the electromagnetic field is strong enough, the ST25TB512-AT enters the Ready state. After Power-up, the Chip\_ID is initialized with a random value. The whole logic is reset and remains in this state until an Initiate() command is issued. Any other command will be ignored by the ST25TB512-AT.

### 6.3 Inventory state

The ST25TB512-AT switches from the Ready to the Inventory state after an Initiate() command has been issued. In Inventory state, the ST25TB512-AT will respond to any anticollision commands: Initiate(), Pcall16() and Slot\_marker(), and then remain in the Inventory state. It will switch to the Selected state after a Select(Chip\_ID) command is issued, if the Chip\_ID in the command matches its own. If not, it will remain in Inventory state.

### 6.4 Selected state

In Selected state, the ST25TB512-AT is active and responds to all Read\_block(), Write\_block() and Get\_UID() commands. When an ST25TB512-AT has entered the Selected state, it no longer responds to anticollision commands. So that the reader can access another tag, the ST25TB512-AT can be switched to the Deselected state by sending a Select(Chip\_ID) with a Chip\_ID that does not match its own, or it can be placed in Deactivated state by issuing a Completion() command. Only one ST25TB512-AT can be in Selected state at a time.

### 6.5 Deselected state

Once the ST25TB512-AT is in Deselected state, only a Select(Chip\_ID) command with a Chip\_ID matching its own can switch it back to Selected state. All other commands are ignored.

## 6.6 Deactivated state

When in this state, the ST25TB512-AT can only be turned off. All commands are ignored.

Figure 13. State transition diagram

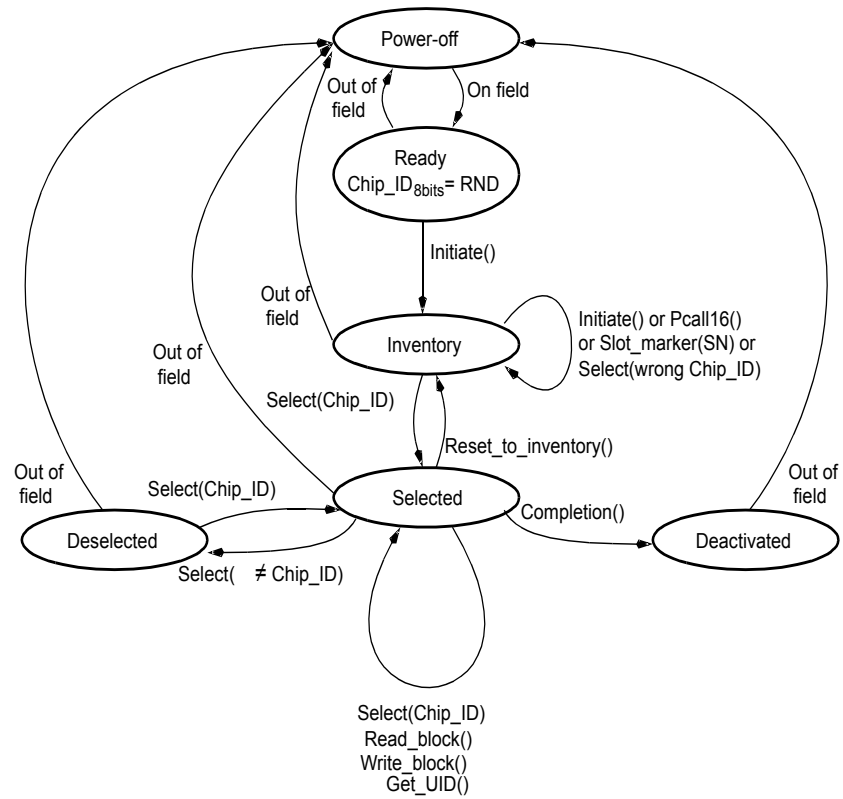



## 7 Anticollision

The **ST25TB512-AT** provides an anticollision mechanism that searches for the **Chip\_ID** of each device that is present in the reader field range. When known, the **Chip\_ID** is used to select an **ST25TB512-AT** individually, and access its memory. The anticollision sequence is managed by the reader through a set of commands described in [Section 8 ST25TB512-AT commands](#):

- **Initiate()**
- **Pcall16()**
- **Slot\_marker()**.

The reader is the master of the communication with one or more **ST25TB512-AT** device(s). It initiates the tag communication activity by issuing an **Initiate()**, **Pcall16()** or **Slot\_marker()** command to prompt the **ST25TB512-AT** to answer. During the anticollision sequence, it might happen that two or more **ST25TB512-AT** devices respond simultaneously, so causing a collision. The command set allows the reader to handle the sequence, to separate **ST25TB512-AT** transmissions into different time slots. Once the anticollision sequence has completed, **ST25TB512-AT** communication is fully under the control of the reader, allowing only one **ST25TB512-AT** to transmit at a time.

The Anticollision scheme is based on the definition of time slots during which the **ST25TB512-AT** devices are invited to answer with minimum identification data: the **Chip\_ID**. The number of slots is fixed at 16 for the **Pcall16()** command. For the **Initiate()** command, there is no slot and the **ST25TB512-AT** answers after the command is issued. **ST25TB512-AT** devices are allowed to answer only once during the anticollision sequence. Consequently, even if there are several **ST25TB512-AT** devices present in the reader field, there will probably be a slot in which only one **ST25TB512-AT** answers, allowing the reader to capture its **Chip\_ID**. Using the **Chip\_ID**, the reader can then establish a communication channel with the identified **ST25TB512-AT**. The purpose of the anticollision sequence is to allow the reader to select one **ST25TB512-AT** at a time.

The **ST25TB512-AT** is given an 8-bit **Chip\_ID** value used by the reader to select only one among up to 256 tags present within its field range. The **Chip\_ID** is initialized with a random value during the Ready state, or after an **Initiate()** command in the Inventory state.

The four least significant bits (**b<sub>0</sub>** to **b<sub>3</sub>**) of the **Chip\_ID** are also known as the **Chip\_slot\_number**. This 4-bit value is used by the **Pcall16()** and **Slot\_marker()** commands during the anticollision sequence in the Inventory state.

**Figure 14. ST25TB512-AT Chip\_ID description**

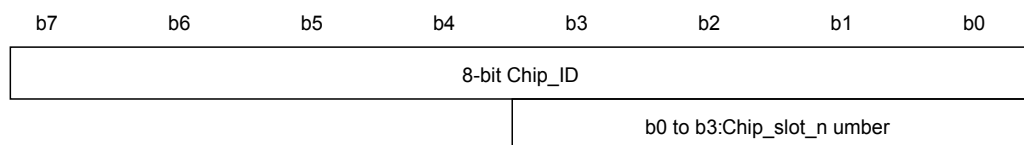

Each time the **ST25TB512-AT** receives a **Pcall16()** command, the **Chip\_slot\_number** is given a new 4-bit random value. If the new value is 0000<sub>b</sub>, the **ST25TB512-AT** returns its whole 8-bit **Chip\_ID** in its answer to the **Pcall16()** command. The **Pcall16()** command is also used to define the slot number 0 of the anticollision sequence. When the **ST25TB512-AT** receives the **Slot\_marker(SN)** command, it compares its **Chip\_slot\_number** with the **Slot\_number** parameter (**SN**). If they match, the **ST25TB512-AT** returns its **Chip\_ID** as a response to the command. If they do not, the **ST25TB512-AT** does not answer. The **Slot\_marker(SN)** command is used to define all the anticollision slot numbers from 1 to 15.

**Figure 15. Description of a possible anticollision sequence**

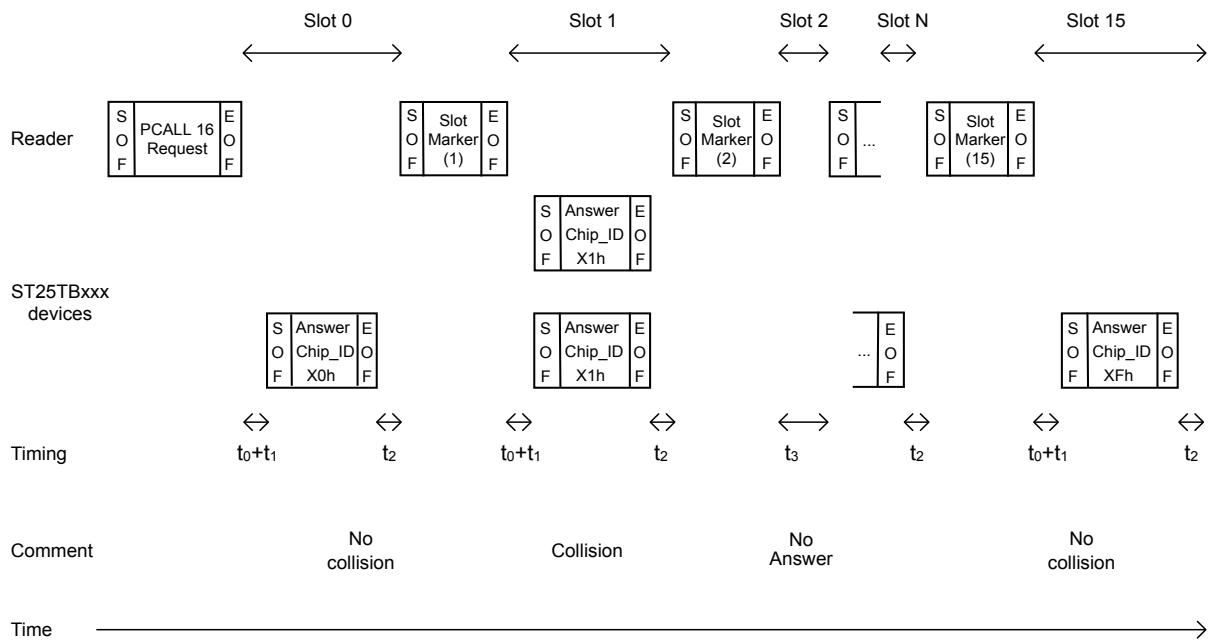

1. The value X in the answer Chip\_ID means a random hexadecimal character from 0 to F.

## 7.1 Description of an anticollision sequence

The anticollision sequence is initiated by the Initiate() command which triggers all the ST25TB512-AT devices that are present in the reader field range, and that are in Inventory state. Only ST25TB512-AT devices in Inventory state will respond to the Pcall16() and Slot\_marker(SN) anticollision commands.

A new ST25TB512-AT introduced in the field range during the anticollision sequence will not be taken into account as it will not respond to the Pcall16() or Slot\_marker(SN) command (Ready state). To be considered during the anticollision sequence, it must have received the Initiate() command and entered the Inventory state.

Table 8 shows the elements of a standard anticollision sequence. (See Table 9 for an example.)

**Table 8. Standard anticollision sequence**

Step 1	Init:	Send Initiate(). <ul style="list-style-type: none"> <li>If no answer is detected, go to step1.</li> <li>If only 1 answer is detected, select and access the <b>ST25TB512-AT</b>. After accessing the <b>ST25TB512-AT</b>, deselect the tag and go to step1.</li> <li>If a collision (many answers) is detected, go to step2.</li> </ul>
Step 2	Slot 0	Send Pcall16(). <ul style="list-style-type: none"> <li>If no answer or collision is detected, go to step3.</li> <li>If 1 answer is detected, store the Chip_ID, Send Select() and go to step3.</li> </ul>
Step 3	Slot 1	Send Slot_marker(1). <ul style="list-style-type: none"> <li>If no answer or collision is detected, go to step4.</li> <li>If 1 answer is detected, store the Chip_ID, Send Select() and go to step4.</li> </ul>
Step 4	Slot 2	Send Slot_marker(2). <ul style="list-style-type: none"> <li>If no answer or collision is detected, go to step5.</li> <li>If 1 answer is detected, store the Chip_ID, Send Select() and go to step5.</li> </ul>
Step N	Slop N	Send Slot_marker(3 up to 14) ... <ul style="list-style-type: none"> <li>If no answer or collision is detected, go to stepN+1.</li> <li>If 1 answer is detected, store the Chip_ID, Send Select() and go to stepN+1.</li> </ul>
Step 17	Slot 15	Send Slot_marker(15). <ul style="list-style-type: none"> <li>If no answer or collision is detected, go to step18.</li> <li>If 1 answer is detected, store the Chip_ID, Send Select() and go to step18.</li> </ul>
Step 18	-	All the slots have been generated and the Chip_ID values should be stored into the reader memory. Issue the Select(Chip_ID) command and access each identified <b>ST25TB512-AT</b> one by one. After accessing each <b>ST25TB512-AT</b> , switch them into Deselected or Deactivated state, depending on the application needs. <ul style="list-style-type: none"> <li>If collisions were detected between Step2 and Step17, go to Step2.</li> <li>If no collision was detected between Step2 and Step17, go to Step1.</li> </ul>

After each Slot\_marker() command, there may be no answer, one or several answers from the **ST25TB512-AT** devices. The reader must handle all the cases and store all the Chip\_IDs, correctly decoded. At the end of the anticollision sequence, after Slot\_marker(15), the reader can start working with one **ST25TB512-AT** by issuing a Select() command containing the desired Chip\_ID. If a collision is detected, the reader has to generate a new sequence in order to identify all unidentified **ST25TB512-AT** devices in the field. The anticollision sequence can stop when all **ST25TB512-AT** devices have been identified.

**Table 9** gives an example of anticollision sequence, the cells containing (\*) highlight the fact that the related tags are not yet identified. When the tag is identified, in the table the (\*) changes to bold character.

**Table 9. Example of an anticollision sequence**

Command	Tag1	Tag2	Tag3	Tag4	Tag5	Tag6	Tag7	Tag8	Comment
	Chip_ID	Chip_ID	Chip_ID	Chip_ID	Chip_ID	Chip_ID	Chip_ID	Chip_ID	
READY state	28h(*)	75h(*)	40h(*)	01h(*)	02h(*)	FEh(*)	A9h(*)	7Ch(*)	Each tag gets a random Chip_ID
INITIATE()	40h(*)	13h(*)	3Fh(*)	4Ah(*)	50h(*)	48h(*)	52h(*)	7Ch(*)	Each tag get a new random Chip_ID. All tags answer: collisions
PCALL16()	45h(*)	12h(*)	30h(*)	43h(*)	55h(*)	43h(*)	53h(*)	73h(*)	All CHIP_SLOT_NUMBERS get a new random value
SELECT(30h)	(*)	(*)	(*)30h	(*)	(*)	(*)	(*)	(*)	Slot0: only one answer
SLOT_MARKER(1)	(*)	(*)	<b>30h</b>	(*)	(*)	(*)-	(*)-	(*)	Slot1: no answer
SLOT_MARKER(2)	(*)	12h(*)	-	(*)	(*)	(*)	(*)	(*)	Slot2: only one answer
SELECT(12h)	(*)	<b>12h</b>	-	(*)	(*)	(*)	(*)	(*)	Tag2 is identified
SLOT_MARKER(3)	(*)	-	-	43h(*)	(*)	43h(*)	53h(*)	73h(*)	Slot3: collision
SLOT_MARKER(4)	(*)	-	-	(*)	(*)	(*)	(*)	(*)	Slot4: no answer

Command	Tag1	Tag2	Tag3	Tag4	Tag5	Tag6	Tag7	Tag8	Comment
	Chip_ID	Chip_ID	Chip_ID	Chip_ID	Chip_ID	Chip_ID	Chip_ID	Chip_ID	
SLOT_MARKER(5)	45h(*)	-	-	(*)	55h(*)	(*)	(*)	(*)	Slot5: collision
SLOT_MARKER(6)	(*)	-	-	(*)	(*)	(*)	(*)	(*)	Slot6: no answer
SLOT_MARKER(N)	(*)	-	-	(*)	(*)	(*)	(*)	(*)	SlotN: no answer
SLOT_MARKER(F)	(*)	-	-	(*)	(*)	(*)	(*)	(*)	SlotF: no answer
PCALL16()	40h(*)	-	-	41h(*)	53h(*)	42h(*)	50h(*)	74h(*)	All CHIP_SLOT_ NUMBERS get a new random value
	40h(*)	-	-	(*)	(*)	(*)	50h(*)	(*)	Slot0: collision
SLOT_MARKER(1)	(*)	-	-	41h(*)	(*)	(*)	(*)	(*)	Slot1: only one answer
SELECT(41h)	(*)	-	-	<b>41h</b>	(*)	(*)	(*)	(*)	Tag4 is identified
SLOT_MARKER(2)	(*)	-	-	-	(*)	42h(*)	(*)	(*)	Slot2: only one answer
SELECT(42h)	(*)	-	-	-	(*)	<b>42h</b>	(*)	(*)	Tag6 is identified
SLOT_MARKER(3)	(*)	-	-	-	53h(*)	-	(*)	(*)	Slot3: only one answer
SELECT(53h)	(*)	-	-	-	<b>53h</b>	-	(*)	(*)	Tag5 is identified
SLOT_MARKER(4)	(*)	-	-	-	-	-	(*)	74h(*)	Slot4: only one answer
SELECT(74h)	(*)	-	-	-	-	-	(*)	<b>74h</b>	Tag8 is identified
SLOT_MARKER(N)	(*)	-	-	-	-	-	(*)	-	SlotN: no answer
PCALL16()	41h(*)	-	-	-	-	-	50h(*)	-	All CHIP_SLOT_ NUMBERS get a new random value
	(*)	-	-	-	-	-	50h(*)	-	Slot0: only one answer
SELECT(50h)	(*)	-	-	-	-	-	<b>50h</b>	-	Tag7 is identified
SLOT_MARKER(1)	41h(*)	-	-	-	-	-	-	-	Slot1: only one answer but already found for tag4
SLOT_MARKER(N)	(*)	-	-	-	-	-	-	-	SlotN: only one answer
PCALL16()	43h(*)	-	-	-	-	-	-	-	All CHIP_SLOT_ NUMBERS get a new random value
	(*)	-	-	-	-	-	-	-	Slot0: only one answer
SLOT_MARKER(3)	43h(*)	-	-	-	-	-	-	-	Slot3: only one answer
SELECT(43h)	<b>43h</b>	-	-	-	-	-	-	-	Tag1 is identified
-	(*)	-	-	-	-	-	-	-	All tags are identified

## 8 ST25TB512-AT commands

See the paragraphs below for a detailed description of the commands available on the ST25TB512-AT. The commands and their hexadecimal codes are summarized in [Table 10](#). A brief is given in [Appendix B ST25TB512-AT command brief](#).

**Table 10. Command code**

Hexadecimal code	Command
06h-00h	Initiate()
06h-04h	Pcall16()
x6h	Slot_marker (SN)
08h	Read_block(Addr)
09h	Write_block(Addr, Data)
0Bh	Get_UID()
0Ch	Reset_to_inventory
0Eh	Select(Chip_ID)
0Fh	Completion()

## 8.1 Initiate() command

Command code = 06h - 00h

Initiate() is used to initiate the anticollision sequence of the ST25TB512-AT. On receiving the Initiate() command, all ST25TB512-AT devices in Ready state switch to Inventory state, set a new 8-bit Chip\_ID random value, and return their Chip\_ID value. This command is useful when only one ST25TB512-AT in Ready state is present in the reader field range. It speeds up the Chip\_ID search process. The Chip\_slot\_number is not used during Initiate() command access.

**Figure 16. Initiate request format**

SOF	Initiate		CRC <sub>L</sub>	CRC <sub>H</sub>	EOF
	06h	00h	8 bits	8 bits	

Request parameter:

- No parameter

**Figure 17. Initiate response format**

SOF	Chip_ID	CRC <sub>L</sub>	CRC <sub>H</sub>	EOF
	8 bits	8 bits	8 bits	

Response parameter:

- Chip\_ID of the ST25TB512-AT

**Figure 18. Initiate frame exchange between reader and ST25TB512-AT**



## 8.2 Pcall16() command

Command code = 06h - 04h

The **ST25TB512-AT** must be in Inventory state to interpret the Pcall16() command.

On receiving the Pcall16() command, the **ST25TB512-AT** first generates a new random Chip\_slot\_number value (in the 4 least significant bits of the Chip\_ID). Chip\_slot\_number can take on a value between 0 and 15 (1111<sub>b</sub>). The value is retained until a new Pcall16() or Initiate() command is issued, or until the **ST25TB512-AT** is powered off. The new Chip\_slot\_number value is then compared with the value 0000<sub>b</sub>. If they match, the **ST25TB512-AT** returns its Chip\_ID value. If not, the **ST25TB512-AT** does not send any response.

The Pcall16() command, used together with the Slot\_marker() command, allows the reader to search for all the Chip\_IDs when there are more than one **ST25TB512-AT** device in Inventory state present in the reader field range.

**Figure 19. Pcall16 request format**

SOF	PCALL16		CRC <sub>L</sub>	CRC <sub>H</sub>	EOF
	06h	04h	8 bits	8 bits	

Request parameter:

- No parameter

**Figure 20. Pcall16 response format**

SOF	Chip_ID	CRC <sub>L</sub>	CRC <sub>H</sub>	EOF
	8 bits	8 bits	8 bits	

Response parameter:

- Chip\_ID of the **ST25TB512-AT**

**Figure 21. Pcall16 frame exchange between reader and ST25TB512-AT**

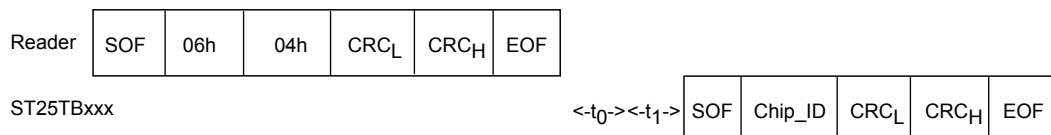

### 8.3 Slot\_marker(SN) command

Command code = x6h

The **ST25TB512-AT** must be in Inventory state to interpret the Slot\_marker(SN) command.

The Slot\_marker byte code is divided into two parts:

- b<sub>3</sub> to b<sub>0</sub>: 4-bit command code with fixed value 6.
- b<sub>7</sub> to b<sub>4</sub>: 4 bits known as the Slot\_number (SN). They assume a value between 1 and 15. The value 0 is reserved by the Pcall16() command.

On receiving the Slot\_marker() command, the **ST25TB512-AT** compares its Chip\_slot\_number value with the Slot\_number value given in the command code. If they match, the **ST25TB512-AT** returns its Chip\_ID value. If not, the **ST25TB512-AT** does not send any response.

The Slot\_marker() command, used together with the Pcall16() command, allows the reader to search for all the Chip\_IDs when there are more than one **ST25TB512-AT** device in Inventory state present in the reader field range.

**Figure 22. Slot\_marker request format**

SOF	Slot_marker	CRC <sub>L</sub>	CRC <sub>H</sub>	EOF
	X6h	8 bits	8 bits	

Request parameter:

- x: Slot number

**Figure 23. Slot\_marker response format**

SOF	Chip_ID	CRC <sub>L</sub>	CRC <sub>H</sub>	EOF
	8 bits	8 bits	8 bits	

Response parameters:

- Chip\_ID of the **ST25TB512-AT**

**Figure 24. Slot\_marker frame exchange between reader and ST25TB512-AT**

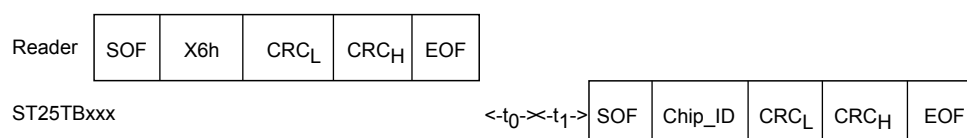

### 8.4 Select(Chip\_ID) command

Command code = 0Eh



The Select() command allows the ST25TB512-AT to enter the Selected state. Until this command is issued, the ST25TB512-AT will not accept any other command, except for Initiate(), Pcall16() and Slot\_marker(). The Select() command returns the 8 bits of the Chip\_ID value. An ST25TB512-AT in Selected state, that receives a Select() command with a Chip\_ID that does not match its own is automatically switched to Deselected state.

**Figure 25. Select request format**

SOF	Select	Chip_ID	CRC <sub>L</sub>	CRC <sub>H</sub>	EOF
	0Eh	8 bits	8 bits	8 bits	

Request parameter:

- 8-bit Chip\_ID stored during the anticollision sequence

**Figure 26. Select response format**

SOF	Chip_ID	CRC <sub>L</sub>	CRC <sub>H</sub>	EOF
	8 bits	8 bits	8 bits	

Response parameters:

- Chip\_ID of the selected tag. Must be equal to the transmitted Chip\_ID

**Figure 27. Select frame exchange between reader and ST25TB512-AT**

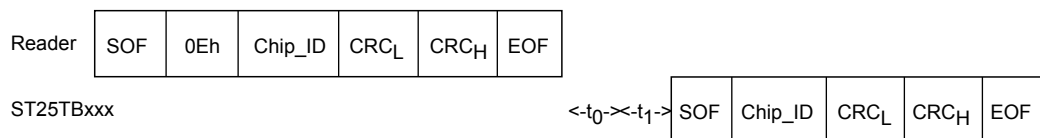

## 8.5 Completion() command

Command code = 0Fh

On receiving the Completion() command, an ST25TB512-AT in Selected state switches to Deactivated state and stops decoding any new commands. The ST25TB512-AT is then locked in this state until a complete reset (tag out of the field range). A new ST25TB512-AT can thus be accessed through a Select() command without having to remove the previous one from the field. The Completion() command does not generate a response.

All ST25TB512-AT devices not in Selected state ignore the Completion() command.

**Figure 28. Completion request format**

SOF	Completion	CRC <sub>L</sub>	CRC <sub>H</sub>	EOF
	0Fh	8 bits	8 bits	

Request parameters:

- No parameter

**Figure 29. Completion response format**

No Response

**Figure 30. Completion frame exchange between reader and ST25TB512-AT**

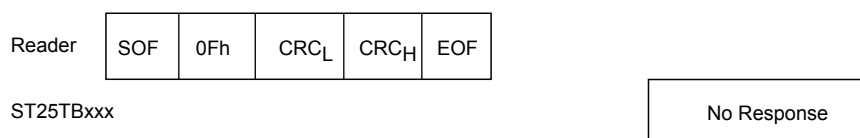

## 8.6 Reset\_to\_inventory() command

Command code = 0Ch

On receiving the Reset\_to\_inventory() command, all ST25TB512-AT devices in Selected state revert to Inventory state. The concerned ST25TB512-AT devices are thus resubmitted to the anticollision sequence. This command is useful when two ST25TB512-AT devices with the same 8-bit Chip\_ID happen to be in Selected state at the same time. Forcing them to go through the anticollision sequence again allows the reader to generate new Pcall16() commands and so, to set new random Chip\_IDs.

The Reset\_to\_inventory() command does not generate a response.

All ST25TB512-AT devices that are not in Selected state ignore the Reset\_to\_inventory() command.

**Figure 31. Reset\_to\_inventory request format**

SOF	RESET_TO_INVENTORY	CRC <sub>L</sub>	CRC <sub>H</sub>	EOF
	0Ch	8 bits	8 bits	

Request parameter:

- No parameter

**Figure 32. Reset\_to\_inventory response format**

No Response

**Figure 33. Reset\_to\_inventory frame exchange between reader and ST25TB512-AT**

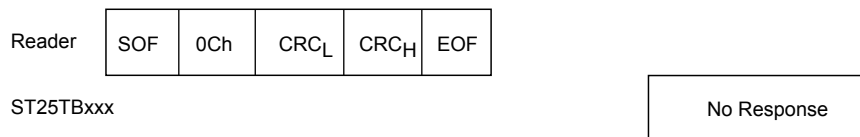

## 8.7 Read\_block(Addr) command

Command code = 08h

On receiving the Read\_block command, the ST25TB512-AT reads the desired block and returns the 4 data bytes contained in the block. Data bytes are transmitted with the least significant byte first and each byte is transmitted with the least significant bit first.

The address byte gives access to the 16 blocks of the ST25TB512-AT (addresses 0 to 15). Read\_block commands issued with a block address above 15 doesn't be interpreted and the ST25TB512-AT doesn't return any response, except for the System area located at address 255.

The ST25TB512-AT must have received a Select() command and be switched to Selected state before any Read\_block() command can be accepted. All Read\_block() commands sent to the ST25TB512-AT before a Select() command is issued are ignored.

**Figure 34. Read\_block request format**

SOF	Read_block	Address	CRC <sub>L</sub>	CRC <sub>H</sub>	EOF
	08h	8 bits	8 bits	8 bits	

Request parameter:

- Address: block addresses from 0 to 15, or 255

**Figure 35. Read\_block response format**

SOF	Data 1	Data 2	Data 3	Data 4	CRC <sub>L</sub>	CRC <sub>H</sub>	EOF
	8 bits	8 bits	8 bits	8 bits	8 bits	8 bits	

Response parameters:

- Data 1: Less significant data byte
- Data 2: Data byte
- Data 3: Data byte
- Data 4: Most significant data byte

**Figure 36. Read\_block frame exchange between reader and ST25TB512-AT**

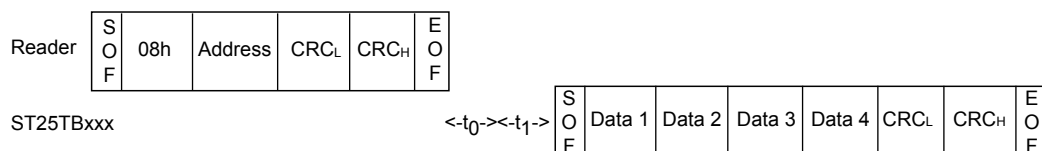

## 8.8 Write\_block (Addr, Data) command

Command code = 09h

On receiving the Write\_block command, the ST25TB512-AT writes the 4 bytes contained in the command to the addressed block, provided that the block is available and not write-protected. Data bytes are transmitted with the least significant byte first, and each byte is transmitted with the least significant bit first.

The address byte gives access to the 16 blocks of the ST25TB512-AT (addresses 0 to 15). Write\_block commands issued with a block address above 15 doesn't be interpreted and the ST25TB512-AT doesn't return any response, except for the System area located at address 255.

The result of the Write\_block command is submitted to the addressed block. See the following tables for a complete description of the Write\_block command:

- [Table 4. Lockable EEPROM area \(addresses 0 to 4\)](#)
- [Table 6. Binary counter \(addresses 5 to 6\).](#)
- [Table 5. EEPROM area \(addresses 7 to 15\)](#)

The Write\_block command does not give rise to a response from the ST25TB512-AT. The reader must check after the programming time,  $t_w$ , that the data was correctly programmed. The ST25TB512-AT must have received a Select() command and be switched to Selected state before any Write\_block command can be accepted. All Write\_block commands sent to the ST25TB512-AT before a Select() command is issued, are ignored.

**Figure 37. Write\_block request format**

SOF	Write_block	Address	Data 1	Data 2	Data 3	Data 4	CRC <sub>L</sub>	CRC <sub>H</sub>	EOF
	09h	8 bits	8 bits	8 bits	8 bits	8 bits	8 bits	8 bits	

- Request parameters:
- Address: block addresses from 0 to 15, or 255
- Data 1: Less significant data byte
- Data 2: Data byte
- Data 3: Data byte
- Data 4: Most significant data byte.

**Figure 38. Write\_block response format**

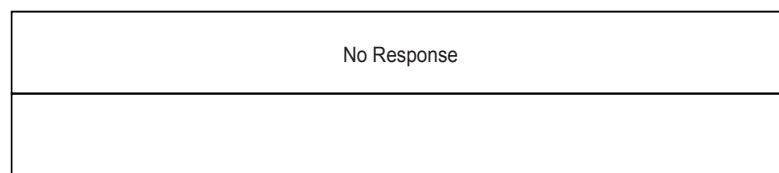

**Figure 39. Write\_block frame exchange between reader and ST25TB512-AT**

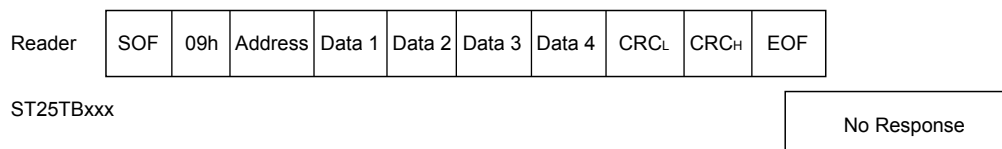

## 8.9 Get\_UID() command

Command code = 0Bh

On receiving the Get\_UID command, the ST25TB512-AT returns its 8 UID bytes. UID bytes are transmitted with the least significant byte first, and each byte is transmitted with the least significant bit first.

The ST25TB512-AT must have received a Select() command and be switched to Selected state before any Get\_UID() command can be accepted. All Get\_UID() commands sent to the ST25TB512-AT before a Select() command is issued, are ignored.

**Figure 40. Get\_UID request format**

SOF	Get_IUD	CRC <sub>L</sub>	CRC <sub>H</sub>	EOF
	0Bh	8 bits	8 bits	

Request parameter:

- No parameter

**Figure 41. Get\_UID response format**

SOF	UID 0	UID 1	UID 2	UID 3	UID 4	UID 5	UID 6	UID 7	CRC <sub>L</sub>	CRC <sub>H</sub>	EOF
	8 bits	8 bits	8 bits	8 bits	8 bits	8 bits	8 bits	8 bits	8 bits	8 bits	

Response parameters:

- UID 0: Less significant UID byte
- UID 1 to UID 6: UID bytes
- UID 7: Most significant UID byte.

### Unique identifier (UID)

Members of the ST25TB512-AT family are uniquely identified by a 64-bit unique identifier (UID). This is used for addressing each ST25TB512-AT device uniquely after the anticollision loop. The UID complies with ISO/IEC 15963 and ISO/IEC 7816-6. It is a read-only code, and comprises (as summarized in Figure 42. 64-bit unique identifier of the ST25TB512-AT):

- an 8-bit prefix, with the most significant bits set to D0h
- an 8-bit IC manufacturer code (ISO/IEC 7816-6/AM1) set to 02h (for STMicroelectronics)
- a 8-bit product ref code set to 33h for ST25TB512-AT
- a 40-bit unique serial number

Figure 42. 64-bit unique identifier of the ST25TB512-AT

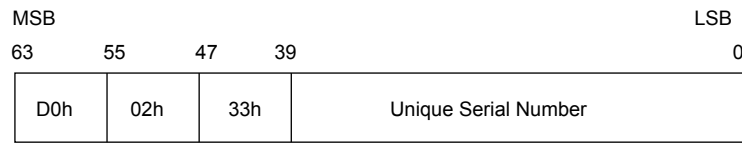
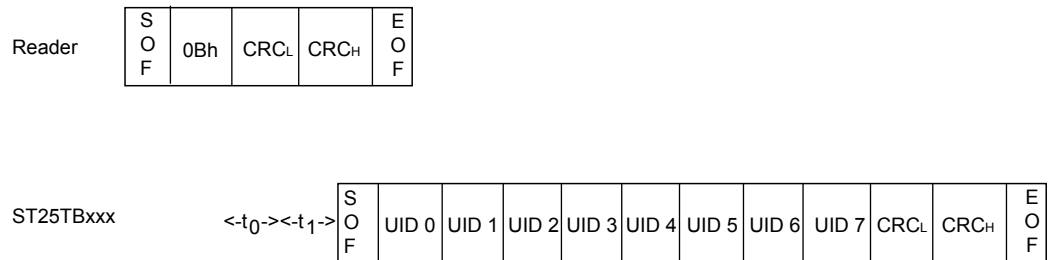

Figure 43. Get\_UID frame exchange between reader and ST25TB512-AT



## 8.10 Power-on state

After power-on, the ST25TB512-AT is in the following state:

- It is in the low-power state.
- It is in Ready state.
- It shows highest impedance with respect to the reader antenna field.
- It will not respond to any command except Initiate().

## 9 Maximum ratings

Stressing the device above the ratings listed in the absolute maximum ratings table may cause permanent damage to the device. These are stress ratings only and operation of the device at these or any other conditions above those indicated in the operating sections of this specification is not implied. Exposure to absolute maximum ratings conditions for extended periods may affect device reliability. Refer also to the STMicroelectronics SURE Program and other relevant quality documents.

**Table 11. Absolute maximum ratings**

Symbol	Parameter	Min.	Max.	Unit	
T <sub>STG</sub> , t <sub>STG</sub>	Storage conditions	Sawn wafer	15	25	°C
		(kept in its original packing form)	-	9 <sup>(1)</sup>	months
		Unsawn wafer	19	25	°C
		(kept in its antistatic bag)	-	23	months
I <sub>CC</sub>	Supply current on AC0 / AC1	-	40	mA	
V <sub>MAX</sub> <sup>(2)</sup>	RF input voltage amplitude between AC0 and AC1, GND pad left floating	-	10	V	
V <sub>ESD</sub>	Electrostatic discharge voltage	-	2000	V	
				Human Body Model <sup>(3)</sup>	

1. Counted from ST shipment date.

2. Based on characterization, not tested in production.

3. Positive and negative pulses applied on different combinations of pin connections, according to AEC-Q100-002 (compliant with ANSI/ESDA/JEDEC JS-001-2012, C1=100 pF, R1=1500 Ω, R2=500 Ω).



## 10 RF electrical parameters

**Table 12. Operating conditions**

Symbol	Parameter	Min.	Max.	Unit
T <sub>A</sub>	Ambient operating temperature	-40	85	°C

**Table 13. Electrical characteristics**

Symbol	Parameter	Condition	Min	Typ	Max	Unit
H_ISO	Operating field according to ISO	T <sub>A</sub> = 0 °C to 50 °C	1500	-	7500	mA/m
H_extended	Operating field in extended temperature range	T <sub>A</sub> = -40 °C to 85 °C	1500	-	7500	
V <sub>RET</sub>	Back-scattering induced voltage	ISO 10373-6	20	-	-	mV
C <sub>TUN</sub>	Internal tuning capacitor	13.56 MHz <sup>(1)</sup>	62	68	74	pF

1. The tuning capacitance value is evaluated by characterization with equipment at chip power on reset and ambient temperature. This value is to be used as reference for antenna design. Min and max value are deduced from correlation at ambient temperature with industrial tester limits

**Note:** For inlay implementation, the antenna design applied for SRT512 can be re-used as-is for ST25TB512-AT: typical 68pF value for the ST25TB512-AT is equivalent to what was specified in the SRT512 data-sheet as 64pF. This change is related to a different measurement methodology between SRT512 and ST25TB512-AT.

**Table 14. RF characteristics**

Symbol	Parameter	Condition	Min	Typ	Max	Unit
f <sub>CC</sub>	RFcarrier frequency	-	13.553	-	13.567	MHz
MI <sub>CARRIER</sub>	Carrier modulation index	MI=(A-B)/(A+B)	8	11	14	%
t <sub>RFR</sub> , t <sub>RFF</sub>	10% Rise and Fall times	-	0.1	-	1.25	µs
t <sub>RFSBL</sub>	Minimum pulse width for Start bit	ETU = 128/f <sub>CC</sub>	-	9.44	-	µs
t <sub>JIT</sub>	ASK modulation data jitter	Coupler to ST25TB512-AT	-2	-	+2	µs
t <sub>MIN CD</sub>	Minimum timefrom carrier generation to first data	-	5	-	-	ms
f <sub>S</sub>	Subcarrier frequency	f <sub>CC</sub> /16	-	847.5	-	kHz
t <sub>0</sub>	Antenna reversal delay	-	-	159	-	µs
t <sub>1</sub>	Synchronization delay	-	-	151	-	µs
t <sub>2</sub>	Answer to new request delay	14 ETU	132	-	-	µs
t <sub>DR</sub>	Time between request characters	Coupler to ST25TB512-AT	0	-	57	µs
t <sub>DA</sub>	Time between answer characters	ST25TB512-AT to coupler	-	0	-	µs
t <sub>W</sub>	Programming time for write	With no auto-erase cycle (OTP)	-	-	3	ms
		With auto-erase cycle (EEPROM)	-	-	5	ms
		Binarycounter decrement with tearing condition	-	-	7	ms

1. All timing measurements were performed on a reference antenna with the following characteristics:
  - External size: 76 mm x 46 mm
  - Number of turns: 4
  - Width of conductor: 0.9 mm
  - Space between 2 conductors: 0.9 mm
  - Tuning Frequency: 13.58 MHz

**Figure 44. ST25TB512-AT synchronous timing, transmit and receive**

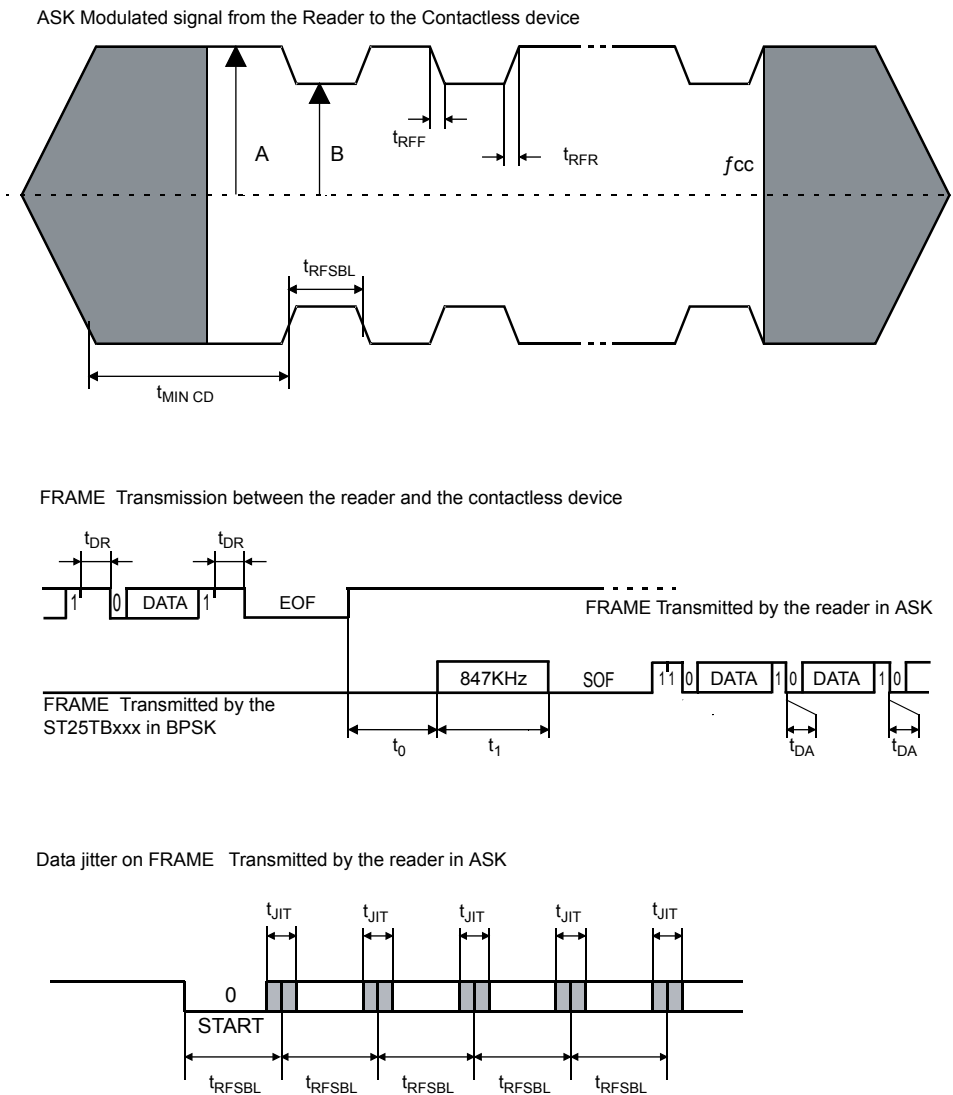

## 11 Ordering information

**Table 15. Ordering information scheme**

Example:	ST25	T	B	512	-A	T	6	G	6
<b>Device type</b>									
ST25 = RF memory									
<b>Product type</b>									
T = Tags + RFID									
<b>Protocol</b>									
B = ISO14443-B									
<b>Memory density</b>									
512 (binary)									
<b>Interface</b>									
A = None									
<b>Features</b>									
T = Transport (+ counter option)									
<b>Device grade</b>									
6 = - 40 to 85 °C									
<b>Package/Packaging</b>									
G = Bumped 120 µm									
U = Unsawn 725 µm									
<b>Capacitor value</b>									
6 = 68 pF									

**Note:** *Devices are shipped from the factory with the memory content bits erased to 1.*  
For a list of available options (speed, package, etc.) or for further information on any aspect of this device, please contact your nearest ST sales office.

## Appendix A ISO-14443 Type B CRC calculation

```

#include <stdio.h>
#include <stdlib.h>
#include <string.h>
#include <ctype.h>
#define BYTE unsigned char
#define USHORT unsigned short
unsigned short UpdateCrc(BYTE ch, USHORT *lpwCrc)
{
  ch = (ch^(BYTE)((*lpwCrc) & 0x00FF));
  ch = (ch^(ch<<4));
  *lpwCrc = (*lpwCrc >> 8)^((USHORT)ch <<
  8)^((USHORT)ch<<3)^((USHORT)ch>>4);
  return(*lpwCrc);
}
void ComputeCrc(char *Data, int Length, BYTE *TransmitFirst, BYTE
*TransmitSecond)
{
  BYTE chBlock; USHORTt wCrc;
  wCrc = 0xFFFF; // ISO 3309
  do
  {
    chBlock = *Data++;
    UpdateCrc(chBlock, &wCrc);
  } while (--Length);
  wCrc = ~wCrc; // ISO 3309
  *TransmitFirst = (BYTE) (wCrc & 0xFF);
  *TransmitSecond = (BYTE) ((wCrc >> 8) & 0xFF);
  return;
}
int main(void)
{
  BYTE BuffCRC_B[10] = {0x0A, 0x12, 0x34, 0x56}, First, Second, i;
  printf("Crc-16 G(x) = x^16 + x^12 + x^5 + 1");
  printf("CRC_B of [ ");
  for(i=0; i<4; i++)
  printf("%02X ",BuffCRC_B[i]);
  ComputeCrc(BuffCRC_B, 4, &First, &Second);
  printf("] Transmitted: %02X then %02X.", First, Second);
  return(0);
}

```

## Appendix B ST25TB512-AT command brief

**Figure 45. Initiate frame exchange between reader and ST25TB512-AT**

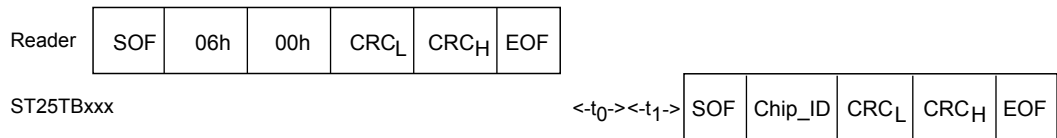

**Figure 46. Pcall16 frame exchange between reader and ST25TB512-AT**

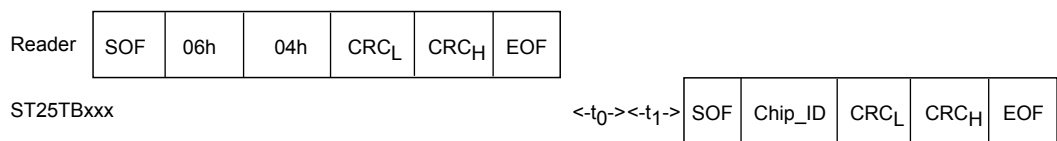

**Figure 47. Slot\_marker frame exchange between reader and ST25TB512-AT**

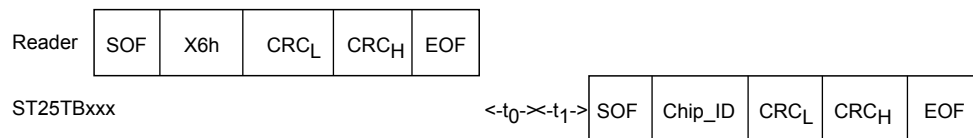

**Figure 48. Select frame exchange between reader and ST25TB512-AT**

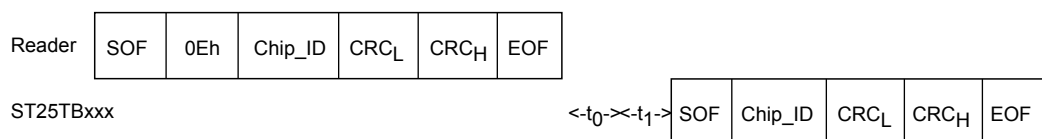

**Figure 49. Completion frame exchange between reader and ST25TB512-AT**

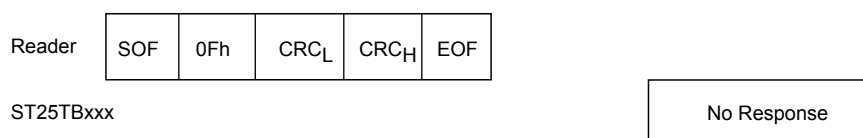

Figure 50. Reset\_to\_inventory frame exchange between reader and ST25TB512-AT



Figure 51. Read\_block frame exchange between reader and ST25TB512-AT

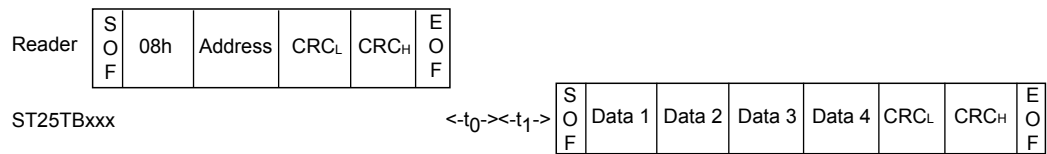

Figure 52. Write\_block frame exchange between reader and ST25TB512-AT

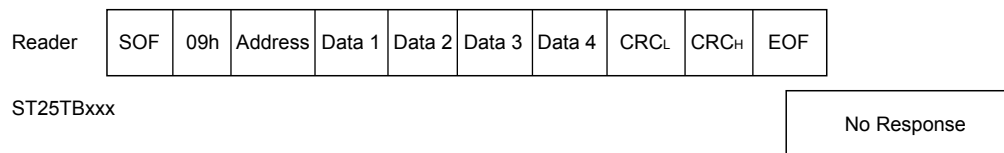
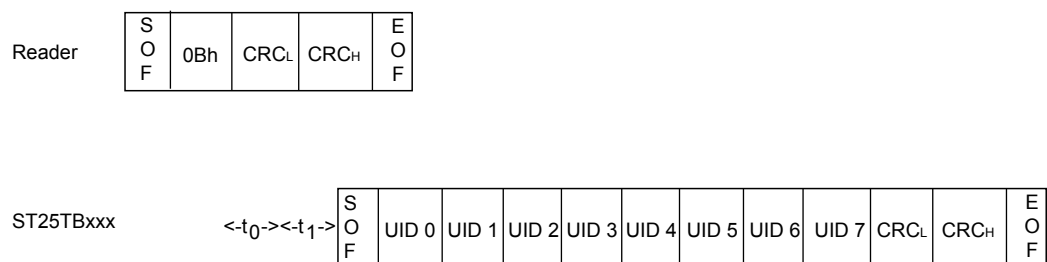

Figure 53. Get\_UID frame exchange between reader and ST25TB512-AT



## Revision history

**Table 16. Document revision history**

Date	Version	Changes
8-Jun-2016	1	Initial release
09-Feb-2016	2	Updated Section 1 Description
03-Mar-2016	3	Updated Figure 26. Select response format, Figure 39. Write_block frame exchange between reader and ST25TB512-AT
19-Apr-2016	4	Changed confidentiality level from ST restricted to public
16-Sep-2016	5	Updated: <ul style="list-style-type: none"> <li>• Figure 42. 64-bit unique identifier of the ST25TB512-AT,</li> <li>Figure 44. ST25TB512-AT synchronous timing, transmit and receive</li> <li>• Section 8.9 Get_UID() command</li> <li>• Table 11. Absolute maximum ratings, Table 15. Ordering information scheme</li> </ul>
11-Nov-2016	6	Updated Features in cover page
20-Sep-2018	7	Updated Section 4.1 EEPROM area, added Section 4.1.1 Block 0 - 4 and Section 4.1.2 Block 7 - 15
07-Feb-2023	8	Updated note 1 in <a href="#">Table 13. Electrical characteristics</a>

## Contents

<b>1</b>	<b>Description</b> .....	<b>2</b>
<b>2</b>	<b>Signal description</b> .....	<b>4</b>
2.1	AC1, AC0 .....	4
<b>3</b>	<b>Data transfer</b> .....	<b>5</b>
3.1	Input data transfer from reader to ST25TB512-AT (request frame) .....	5
3.1.1	Character transmission format for request frame .....	5
3.1.2	Request start of frame .....	5
3.1.3	Request end of frame .....	6
3.2	Output data transfer from to reader ST25TB512-AT (answer frame) .....	7
3.2.1	Character transmission format for answer frame .....	7
3.2.2	Answer start of frame .....	7
3.2.3	Answer end of frame .....	8
3.3	Trasmission frame .....	8
3.4	CRC .....	9
<b>4</b>	<b>Memory mapping</b> .....	<b>10</b>
4.1	EEPROM area .....	11
4.1.1	Block 0-4 .....	11
4.1.2	block 7-15 .....	11
4.2	32-bit binary counters .....	12
4.3	System area .....	13
4.3.1	OTP_Lock_Reg .....	13
<b>5</b>	<b>ST25TB512-AT operation</b> .....	<b>14</b>
<b>6</b>	<b>ST25TB512-AT states</b> .....	<b>15</b>
6.1	Power-off state .....	15
6.2	Ready state .....	15
6.3	Inventory state .....	15
6.4	Selected state .....	15
6.5	Deselected state .....	15
6.6	Deactivated state .....	16
<b>7</b>	<b>Anticollision</b> .....	<b>17</b>
7.1	Description of an anticollision sequence .....	18
<b>8</b>	<b>ST25TB512-AT commands</b> .....	<b>21</b>
8.1	Initiate() command .....	22
8.2	Pcall16() command .....	23



---

8.3	Slot_marker(SN) command .....	24
8.4	Select(Chip_ID) command .....	24
8.5	Completion() command .....	26
8.6	Reset_to_inventory() command .....	27
8.7	Read_block(Addr) command .....	28
8.8	Write_block (Addr, Data) command .....	28
8.9	Get_UID() command .....	30
8.10	Power-on state .....	31
<b>9</b>	<b>Maximum ratings .....</b>	<b>32</b>
<b>10</b>	<b>RF electrical parameters .....</b>	<b>33</b>
<b>11</b>	<b>Ordering information .....</b>	<b>35</b>
<b>Appendix A</b>	<b>ISO-14443 Type B CRC calculation .....</b>	<b>36</b>
<b>Appendix B</b>	<b>ST25TB512-AT command brief .....</b>	<b>37</b>
	<b>Revision history .....</b>	<b>39</b>

## List of tables

<b>Table 1.</b>	Signal names . . . . .	2
<b>Table 2.</b>	Bit description . . . . .	5
<b>Table 3.</b>	ST25TB512-AT memory mapping . . . . .	10
<b>Table 4.</b>	Lockable EEPROM area (addresses 0 to 4) . . . . .	11
<b>Table 5.</b>	EEPROM area (addresses 7 to 15) . . . . .	11
<b>Table 6.</b>	Binary counter (addresses 5 to 6). . . . .	12
<b>Table 7.</b>	System area . . . . .	13
<b>Table 8.</b>	Standard anticollision sequence. . . . .	19
<b>Table 9.</b>	Example of an anticollision sequence . . . . .	19
<b>Table 10.</b>	Command code . . . . .	21
<b>Table 11.</b>	Absolute maximum ratings . . . . .	32
<b>Table 12.</b>	Operating conditions . . . . .	33
<b>Table 13.</b>	Electrical characteristics . . . . .	33
<b>Table 14.</b>	RF characteristics . . . . .	33
<b>Table 15.</b>	Ordering information scheme. . . . .	35
<b>Table 16.</b>	Document revision history . . . . .	39

## List of figures

<b>Figure 1.</b>	Logic diagram. . . . .	2
<b>Figure 2.</b>	Die floor plan and assembly options . . . . .	3
<b>Figure 3.</b>	ST25TB512-AT 10% ASK modulation of the received wave . . . . .	5
<b>Figure 4.</b>	ST25TB512-AT request frame character format . . . . .	5
<b>Figure 5.</b>	Request start of frame . . . . .	6
<b>Figure 6.</b>	Request end of frame . . . . .	6
<b>Figure 7.</b>	Wave transmitted using BPSK subcarrier modulation. . . . .	7
<b>Figure 8.</b>	Answer start of frame . . . . .	7
<b>Figure 9.</b>	Answer end of frame . . . . .	8
<b>Figure 10.</b>	Example of a complete transmission frame. . . . .	8
<b>Figure 11.</b>	CRC transmission rules . . . . .	9
<b>Figure 12.</b>	Countdown example (binary format) . . . . .	12
<b>Figure 13.</b>	State transition diagram . . . . .	16
<b>Figure 14.</b>	ST25TB512-AT Chip_ID description . . . . .	17
<b>Figure 15.</b>	Description of a possible anticollision sequence . . . . .	18
<b>Figure 16.</b>	Initiate request format . . . . .	22
<b>Figure 17.</b>	Initiate response format . . . . .	22
<b>Figure 18.</b>	Initiate frame exchange between reader and ST25TB512-AT . . . . .	22
<b>Figure 19.</b>	Pcall16 request format. . . . .	23
<b>Figure 20.</b>	Pcall16 response format . . . . .	23
<b>Figure 21.</b>	Pcall16 frame exchange between reader and ST25TB512-AT. . . . .	23
<b>Figure 22.</b>	Slot_marker request format . . . . .	24
<b>Figure 23.</b>	Slot_marker response format . . . . .	24
<b>Figure 24.</b>	Slot_marker frame exchange between reader and ST25TB512-AT . . . . .	24
<b>Figure 25.</b>	Select request format . . . . .	25
<b>Figure 26.</b>	Select response format . . . . .	25
<b>Figure 27.</b>	Select frame exchange between reader and ST25TB512-AT . . . . .	25
<b>Figure 28.</b>	Completion request format . . . . .	26
<b>Figure 29.</b>	Completion response format. . . . .	26
<b>Figure 30.</b>	Completion frame exchange between reader and ST25TB512-AT . . . . .	26
<b>Figure 31.</b>	Reset_to_inventory request format . . . . .	27
<b>Figure 32.</b>	Reset_to_inventory response format . . . . .	27
<b>Figure 33.</b>	Reset_to_inventory frame exchange between reader and ST25TB512-AT . . . . .	27
<b>Figure 34.</b>	Read_block request format . . . . .	28
<b>Figure 35.</b>	Read_block response format . . . . .	28
<b>Figure 36.</b>	Read_block frame exchange between reader and ST25TB512-AT . . . . .	28
<b>Figure 37.</b>	Write_block request format. . . . .	29
<b>Figure 38.</b>	Write_block response format . . . . .	29
<b>Figure 39.</b>	Write_block frame exchange between reader and ST25TB512-AT . . . . .	29
<b>Figure 40.</b>	Get_UID request format. . . . .	30
<b>Figure 41.</b>	Get_UID response format . . . . .	30
<b>Figure 42.</b>	64-bit unique identifier of the ST25TB512-AT . . . . .	31
<b>Figure 43.</b>	Get_UID frame exchange between reader and ST25TB512-AT. . . . .	31
<b>Figure 44.</b>	ST25TB512-AT synchronous timing, transmit and receive . . . . .	34
<b>Figure 45.</b>	Initiate frame exchange between reader and ST25TB512-AT . . . . .	37
<b>Figure 46.</b>	Pcall16 frame exchange between reader and ST25TB512-AT. . . . .	37
<b>Figure 47.</b>	Slot_marker frame exchange between reader and ST25TB512-AT . . . . .	37
<b>Figure 48.</b>	Select frame exchange between reader and ST25TB512-AT . . . . .	37
<b>Figure 49.</b>	Completion frame exchange between reader and ST25TB512-AT . . . . .	37
<b>Figure 50.</b>	Reset_to_inventory frame exchange between reader and ST25TB512-AT . . . . .	38
<b>Figure 51.</b>	Read_block frame exchange between reader and ST25TB512-AT . . . . .	38
<b>Figure 52.</b>	Write_block frame exchange between reader and ST25TB512-AT . . . . .	38
<b>Figure 53.</b>	Get_UID frame exchange between reader and ST25TB512-AT. . . . .	38

**IMPORTANT NOTICE – READ CAREFULLY**

STMicroelectronics NV and its subsidiaries (“ST”) reserve the right to make changes, corrections, enhancements, modifications, and improvements to ST products and/or to this document at any time without notice. Purchasers should obtain the latest relevant information on ST products before placing orders. ST products are sold pursuant to ST’s terms and conditions of sale in place at the time of order acknowledgment.

Purchasers are solely responsible for the choice, selection, and use of ST products and ST assumes no liability for application assistance or the design of purchasers’ products.

No license, express or implied, to any intellectual property right is granted by ST herein.

Resale of ST products with provisions different from the information set forth herein shall void any warranty granted by ST for such product.

ST and the ST logo are trademarks of ST. For additional information about ST trademarks, refer to [www.st.com/trademarks](http://www.st.com/trademarks). All other product or service names are the property of their respective owners.

Information in this document supersedes and replaces information previously supplied in any prior versions of this document.

© 2023 STMicroelectronics – All rights reserved