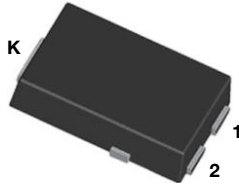
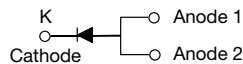

SMD Photovoltaic Solar Cell Protection Schottky Rectifier

eSMP® Series

SMPC (TO-277A)

FEATURES

- Very low profile - typical height of 1.1 mm
- Ideal for automated placement
- Guardring for overvoltage protection
- Low forward voltage drop, low power losses
- High efficiency
- Low thermal resistance
- Meets MSL level 1, per J-STD-020, LF maximum peak of 260 °C
- Material categorization: for definitions of compliance please see www.vishay.com/doc?99912

RoHS
 COMPLIANT
 HALOGEN
FREE
TYPICAL APPLICATIONS

For use in solar cell junction box as a bypass diode for protection, using DC forward current without reverse bias.

MECHANICAL DATA

Case: SMPC (TO-277A)

Molding compound meets UL 94 V-0 flammability rating Base P/N-M3 - halogen-free, RoHS-compliant, and commercial grade

Terminals: matte tin plated leads, solderable per J-STD-002 and JESD 22-B102

M3 suffix meets JESD 201 class 2 whisker test

LINKS TO ADDITIONAL RESOURCES

PRIMARY CHARACTERISTICS

$I_{F(AV)}$	12 A
V_{RRM}	40 V
I_{FSM}	280 A
E_{AS}	20 mJ
V_F at $I_F = 12$ A	0.43 V
T_J max.	150 °C
Package	SMPC (TO-277A)
Circuit configuration	Single

MAXIMUM RATINGS ($T_A = 25$ °C unless otherwise noted)

PARAMETER	SYMBOL	SS12P4S	UNIT
Device marking code		124S	
Maximum repetitive peak reverse voltage	V_{RRM}	40	V
Maximum DC forward current (fig. 1)	I_F	12 ⁽¹⁾ 4.4 ⁽²⁾	A
Peak forward surge current 10 ms single half sine-wave superimposed on rated load	I_{FSM}	280	A
Non-repetitive avalanche energy at $I_{AS} = 2.0$ A, $T_J = 25$ °C	E_{AS}	20	mJ
Operating junction and storage temperature range	T_{OP}, T_{STG}	-55 to +150	°C
Junction temperature in DC forward current without reverse bias, $t \leq 1$ h ⁽³⁾	T_J	≤ 200	°C

Notes

- (1) Mounted on 30 mm x 30 mm Al PCB with 50 mm x 25 mm x 100 mm fin heat sink
- (2) Free air, mounted on recommended copper pad area
- (3) Meets the requirements of IEC 61215 Ed. 2 bypass diode thermal test



ELECTRICAL CHARACTERISTICS ($T_A = 25\text{ }^\circ\text{C}$ unless otherwise noted)						
PARAMETER	TEST CONDITIONS	SYMBOL	TYP.	MAX.	UNIT	
Instantaneous forward voltage	$I_F = 6\text{ A}$	$T_A = 25\text{ }^\circ\text{C}$	$V_F^{(1)}$	0.43	-	V
	$I_F = 12\text{ A}$			0.50	0.60	
	$I_F = 6\text{ A}$	$T_A = 125\text{ }^\circ\text{C}$		0.33	-	
	$I_F = 12\text{ A}$			0.43	0.52	
Reverse current	$V_R = 40\text{ V}$	$T_A = 25\text{ }^\circ\text{C}$	$I_R^{(2)}$	100	800	μA
		$T_A = 125\text{ }^\circ\text{C}$		50	100	mA
Typical junction capacitance	4.0 V, 1 MHz	C_J	750	-	pF	

Notes(1) Pulse test: 300 μs pulse width, 1 % duty cycle(2) Pulse test: Pulse width $\leq 40\text{ ms}$

THERMAL CHARACTERISTICS ($T_A = 25\text{ }^\circ\text{C}$ unless otherwise noted)			
PARAMETER	SYMBOL	VALUE	UNIT
Typical thermal resistance	$R_{\theta JA}^{(1)}$	100	$^\circ\text{C/W}$
	$R_{\theta JM}^{(2)}$	3	

Notes(1) Free air, mounted on recommended copper pad area. Thermal resistance $R_{\theta JA}$ - junction to ambient.(2) Mounted on 30 mm x 30 mm Al PCB with 50 mm x 25 mm x 100 mm fin heat sink. Thermal resistance $R_{\theta JM}$ - junction to mount.

ORDERING INFORMATION (Example)				
PREFERRED P/N	UNIT WEIGHT (g)	PREFERRED PACKAGE CODE	BASE QUANTITY	DELIVERY MODE
SS12P4S-M3/86A	0.10	86A	1500	7" diameter plastic tape and reel
SS12P4S-M3/87A	0.10	87A	6500	13" diameter plastic tape and reel

RATINGS AND CHARACTERISTICS CURVES ($T_A = 25\text{ }^\circ\text{C}$ unless otherwise noted)

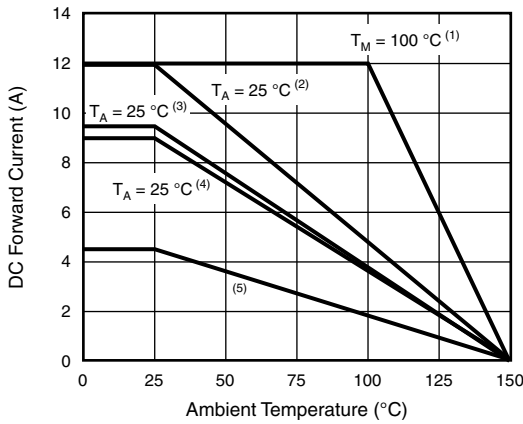

Fig. 1 - Maximum Current Derating Curve

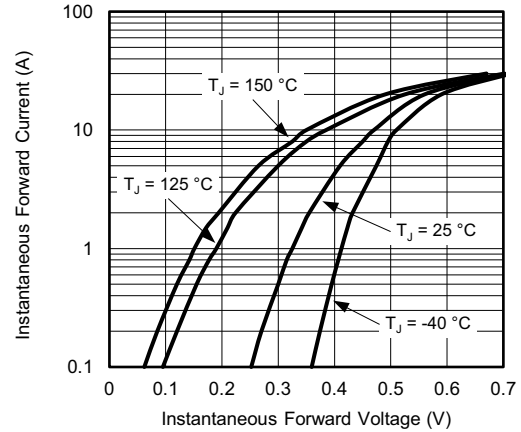

Fig. 3 - Typical Instantaneous Forward Characteristics

Notes

- (1) Mounted on 30 mm x 30 mm Al PCB with 50 mm x 25 mm x 100 mm fin heat sink, T_M measured at the terminal of cathode band
- (2) Mounted on 30 mm x 30 mm Al PCB ($R_{\theta JA} = 20\text{ }^\circ\text{C/W}$)
- (3) Mounted on 30 mm x 30 mm x 2 copper pad areas FR4 PCB ($R_{\theta JA} = 30\text{ }^\circ\text{C/W}$)
- (4) Mounted on 25 mm x 25 mm x 2 copper pad areas FR4 PCB ($R_{\theta JA} = 30\text{ }^\circ\text{C/W}$)
- (5) Free air, mounted on recommended copper pad area ($R_{\theta JA} = 100\text{ }^\circ\text{C/W}$)

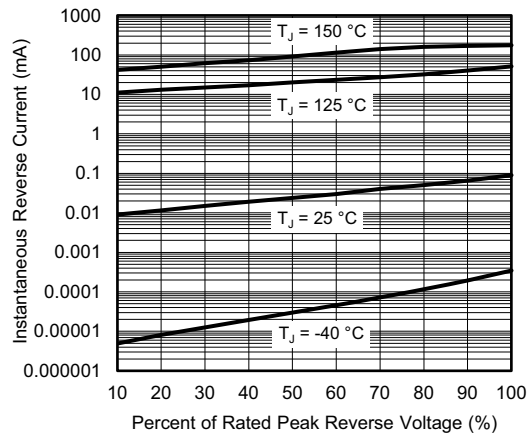

Fig. 4 - Typical Reverse Leakage Characteristics

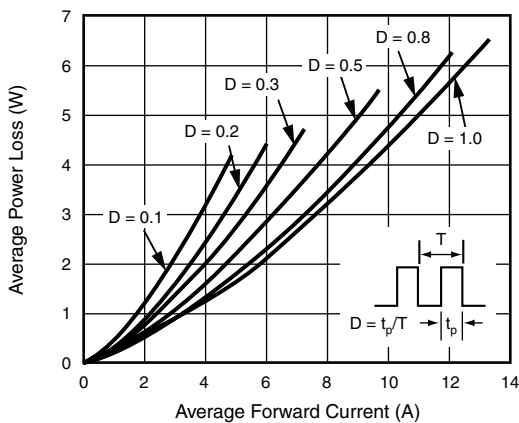

Fig. 2 - Forward Power Loss Characteristics

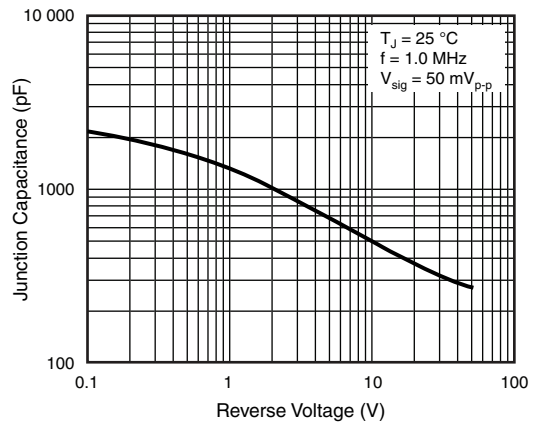
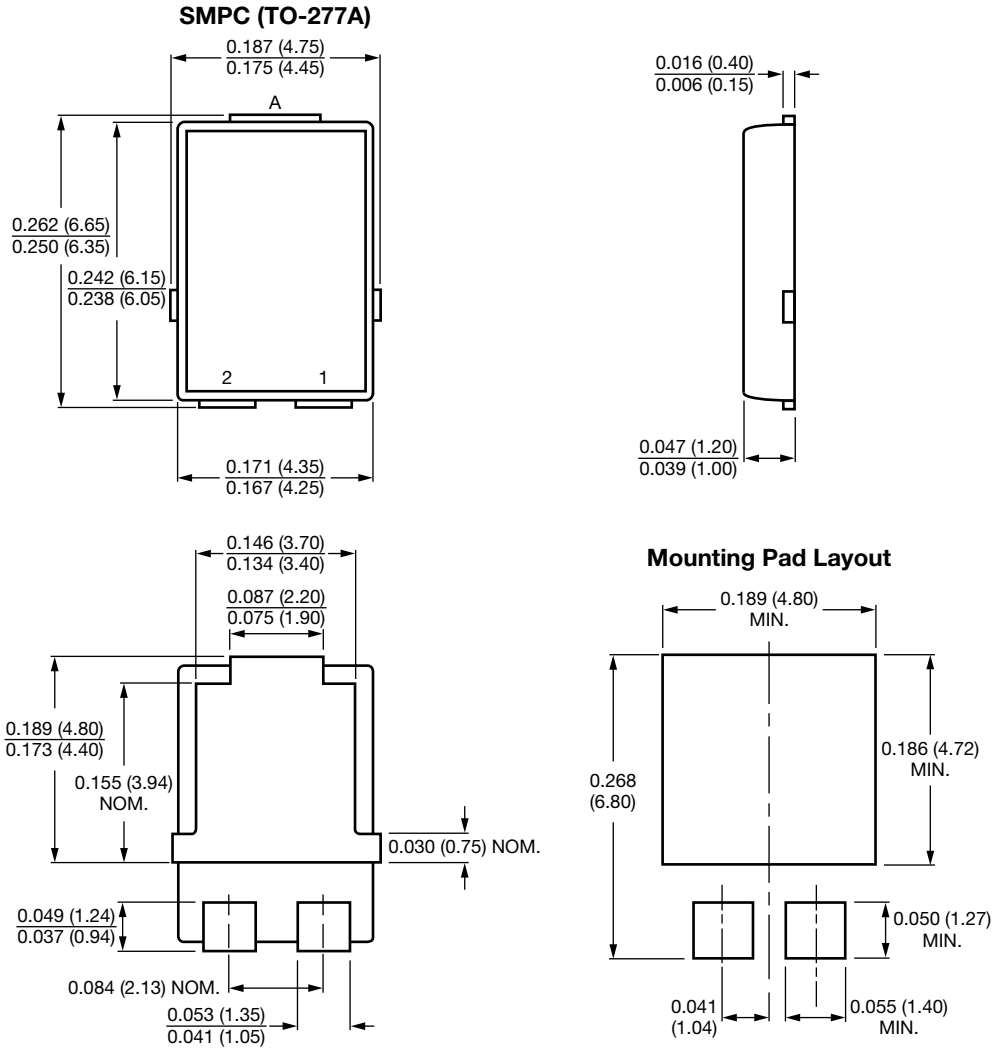

Fig. 5 - Typical Junction Capacitance



PACKAGE OUTLINE DIMENSIONS in inches (millimeters)



Conform to JEDEC® TO-277A



Disclaimer

ALL PRODUCT, PRODUCT SPECIFICATIONS AND DATA ARE SUBJECT TO CHANGE WITHOUT NOTICE TO IMPROVE RELIABILITY, FUNCTION OR DESIGN OR OTHERWISE.

Vishay Intertechnology, Inc., its affiliates, agents, and employees, and all persons acting on its or their behalf (collectively, "Vishay"), disclaim any and all liability for any errors, inaccuracies or incompleteness contained in any datasheet or in any other disclosure relating to any product.

Vishay makes no warranty, representation or guarantee regarding the suitability of the products for any particular purpose or the continuing production of any product. To the maximum extent permitted by applicable law, Vishay disclaims (i) any and all liability arising out of the application or use of any product, (ii) any and all liability, including without limitation special, consequential or incidental damages, and (iii) any and all implied warranties, including warranties of fitness for particular purpose, non-infringement and merchantability.

Statements regarding the suitability of products for certain types of applications are based on Vishay's knowledge of typical requirements that are often placed on Vishay products in generic applications. Such statements are not binding statements about the suitability of products for a particular application. It is the customer's responsibility to validate that a particular product with the properties described in the product specification is suitable for use in a particular application. Parameters provided in datasheets and / or specifications may vary in different applications and performance may vary over time. All operating parameters, including typical parameters, must be validated for each customer application by the customer's technical experts. Product specifications do not expand or otherwise modify Vishay's terms and conditions of purchase, including but not limited to the warranty expressed therein.

Hyperlinks included in this datasheet may direct users to third-party websites. These links are provided as a convenience and for informational purposes only. Inclusion of these hyperlinks does not constitute an endorsement or an approval by Vishay of any of the products, services or opinions of the corporation, organization or individual associated with the third-party website. Vishay disclaims any and all liability and bears no responsibility for the accuracy, legality or content of the third-party website or for that of subsequent links.

Except as expressly indicated in writing, Vishay products are not designed for use in medical, life-saving, or life-sustaining applications or for any other application in which the failure of the Vishay product could result in personal injury or death. Customers using or selling Vishay products not expressly indicated for use in such applications do so at their own risk. Please contact authorized Vishay personnel to obtain written terms and conditions regarding products designed for such applications.

No license, express or implied, by estoppel or otherwise, to any intellectual property rights is granted by this document or by any conduct of Vishay. Product names and markings noted herein may be trademarks of their respective owners.