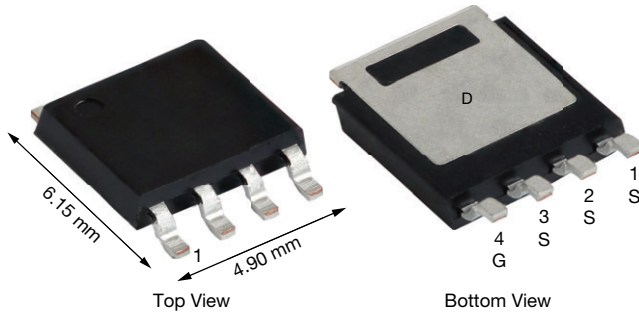
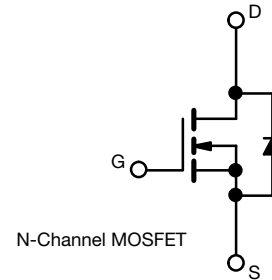

Automotive N-Channel 80 V (D-S) 175 °C MOSFET

PowerPAK® SO-8L

FEATURES

- TrenchFET® Gen IV power MOSFET
- AEC-Q101 qualified
- 100 % R_g and UIS tested
- Q_{gd}/Q_{gs} ratio < 1 optimizes switching characteristics
- Material categorization: for definitions of compliance please see www.vishay.com/doc?99912

AUTOMOTIVE GRADE

RoHS
 COMPLIANT
 HALOGEN
FREE

PRODUCT SUMMARY	
V _{DS} (V)	80
R _{DS(on)} (Ω) at V _{GS} = 10 V	0.0030
I _D (A)	248
Configuration	Single
Package	PowerPAK SO-8L

ABSOLUTE MAXIMUM RATINGS (T _C = 25 °C, unless otherwise noted)				
PARAMETER	SYMBOL	LIMIT	UNIT	
Drain-source voltage	V _{DS}	80	V	
Gate-source voltage	V _{GS}	± 20		
Continuous drain current	I _D	T _C = 25 °C	248	A
		T _C = 125 °C	143	
Continuous source current (diode conduction)	I _S	248		
Pulsed drain current	I _{DM}	420		
Single pulse avalanche current	I _{AS}	42		
Single pulse avalanche energy	E _{AS}	88	mJ	
Maximum power dissipation	P _D	T _C = 25 °C	500	W
		T _C = 125 °C	166	
Operating junction and storage temperature range	T _J , T _{stg}	-55 to +175	°C	
Soldering recommendations (peak temperature) ^b		260		

THERMAL RESISTANCE RATINGS				
PARAMETER	SYMBOL	LIMIT	UNIT	
Junction-to-ambient	R _{thJA}	42	°C/W	
Junction-to-case (drain)	R _{thJC}	0.3		

Notes

- When mounted on 1" square PCB (FR4 material)
- See solder profile (www.vishay.com/doc?73257). The end of the lead terminal is exposed copper (not plated) as a result of the singulation process in manufacturing. A solder fillet at the exposed copper tip cannot be guaranteed and is not required to ensure adequate bottom side solder interconnection



SPECIFICATIONS ($T_C = 25\text{ }^\circ\text{C}$, unless otherwise noted)						
PARAMETER	SYMBOL	TEST CONDITIONS	MIN.	TYP.	MAX.	UNIT
Static						
Drain-source breakdown voltage	V_{DS}	$V_{GS} = 0, I_D = 250\text{ }\mu\text{A}$	80	-	-	V
Gate-source threshold voltage	$V_{GS(th)}$	$V_{DS} = V_{GS}, I_D = 250\text{ }\mu\text{A}$	2.2	2.7	3.5	
Gate-source leakage	I_{GSS}	$V_{DS} = 0\text{ V}, V_{GS} = \pm 20\text{ V}$	-	-	± 100	nA
Zero gate voltage drain current	I_{DSS}	$V_{GS} = 0\text{ V}$ $V_{DS} = 80\text{ V}$	-	-	10	μA
		$V_{GS} = 0\text{ V}$ $V_{DS} = 80\text{ V}, T_J = 125\text{ }^\circ\text{C}$	-	-	50	
		$V_{GS} = 0\text{ V}$ $V_{DS} = 80\text{ V}, T_J = 175\text{ }^\circ\text{C}$	-	-	250	
On-state drain current ^a	$I_{D(on)}$	$V_{GS} = 10\text{ V}$ $V_{DS} \geq 5\text{ V}$	30	-	-	A
Drain-source on-state resistance ^a	$R_{DS(on)}$	$V_{GS} = 10\text{ V}$ $I_D = 15\text{ A}$	-	0.0025	0.0030	Ω
		$V_{GS} = 10\text{ V}$ $I_D = 15\text{ A}, T_J = 125\text{ }^\circ\text{C}$	-	-	0.0059	
		$V_{GS} = 10\text{ V}$ $I_D = 15\text{ A}, T_J = 175\text{ }^\circ\text{C}$	-	-	0.0075	
Forward transconductance ^b	g_{fs}	$V_{DS} = 15\text{ V}, I_D = 10\text{ A}$	-	82	-	S
Dynamic ^b						
Input capacitance	C_{iss}	$V_{GS} = 0\text{ V}$ $V_{DS} = 25\text{ V}, f = 1\text{ MHz}$	-	4746	6645	pF
Output capacitance	C_{oss}		-	814	1140	
Reverse transfer capacitance	C_{rss}		-	51	72	
Total gate charge ^c	Q_g	$V_{GS} = 10\text{ V}$ $V_{DS} = 40\text{ V}, I_D = 10\text{ A}$	-	78	117	nC
Gate-source charge ^c	Q_{gs}		-	18	-	
Gate-drain charge ^c	Q_{gd}		-	16	-	
Gate resistance	R_g	$f = 1\text{ MHz}$	0.5	1.0	1.50	Ω
Turn-on delay time ^c	$t_{d(on)}$	$V_{DD} = 40\text{ V}, R_L = 4\text{ }\Omega$ $I_D \cong 10\text{ A}, V_{GEN} = 10\text{ V}, R_g = 1\text{ }\Omega$	-	16	20	ns
Rise time ^c	t_r		-	10	15	
Turn-off delay time ^c	$t_{d(off)}$		-	39	50	
Fall time ^c	t_f		-	9	15	
Source-Drain Diode Ratings and Characteristics ^b						
Pulsed current ^a	I_{SM}		-	-	420	A
Forward voltage	V_{SD}	$I_F = 15\text{ A}, V_{GS} = 0\text{ V}$	-	-	1.1	V
Body diode reverse recovery time	t_{rr}	$I_F = 10\text{ A}, di/dt = 100\text{ A}/\mu\text{s}$	-	50	65	ns
Body diode reverse recovery charge	Q_{rr}		-	71	95	nC
Reverse recovery fall time	t_a		-	28	44	ns
Reverse recovery rise time	t_b		-	22	38	
Body diode peak reverse recovery current	$I_{RM(REC)}$			-	2.4	3.6

Notes

- a. Pulse test; pulse width $\leq 300\text{ }\mu\text{s}$, duty cycle $\leq 2\%$
- b. Guaranteed by design, not subject to production testing
- c. Independent of operating temperature

Stresses beyond those listed under "Absolute Maximum Ratings" may cause permanent damage to the device. These are stress ratings only, and functional operation of the device at these or any other conditions beyond those indicated in the operational sections of the specifications is not implied. Exposure to absolute maximum rating conditions for extended periods may affect device reliability.

TYPICAL CHARACTERISTICS ($T_A = 25\text{ }^\circ\text{C}$, unless otherwise noted)

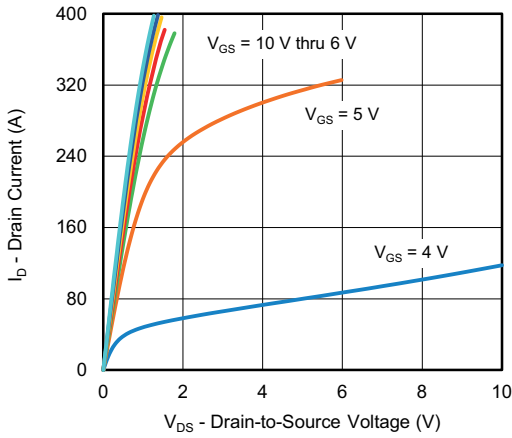

Output Characteristics

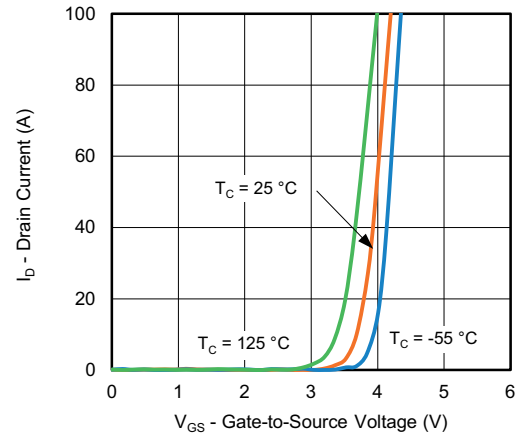

Transfer Characteristics

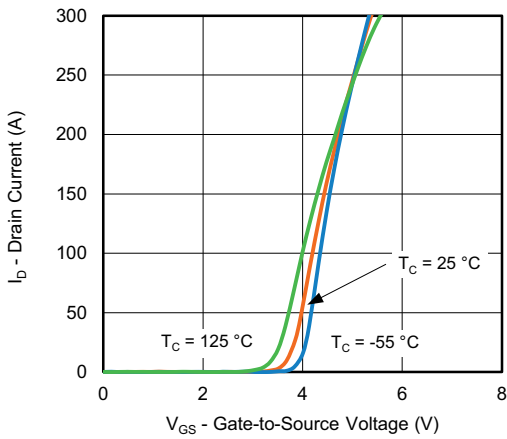

Transfer Characteristics

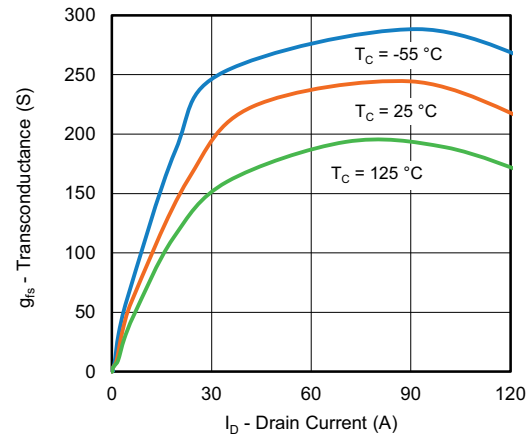

Transconductance

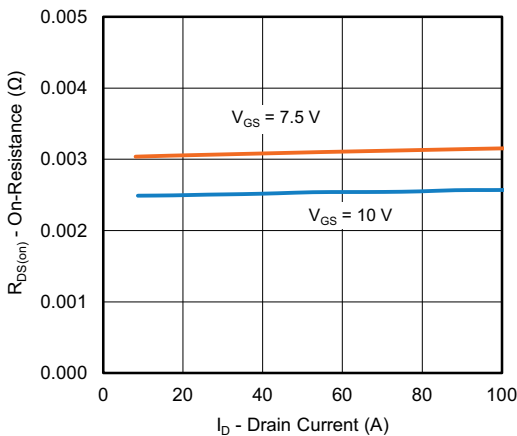

On-Resistance vs. Drain Current

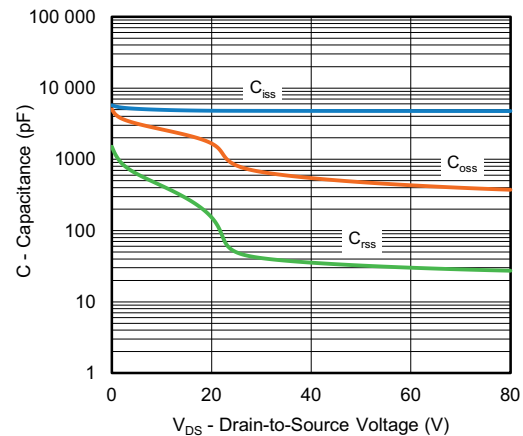

Capacitance



TYPICAL CHARACTERISTICS (T_A = 25 °C, unless otherwise noted)

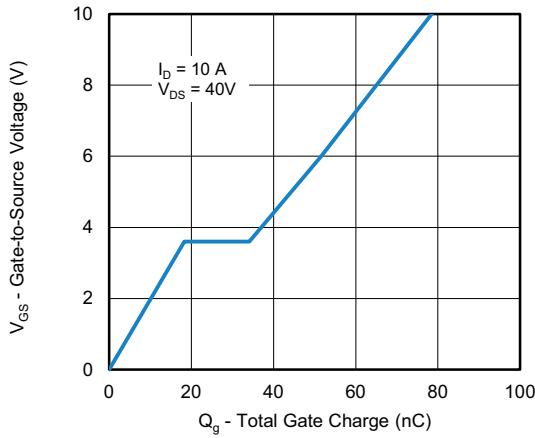

Gate Charge

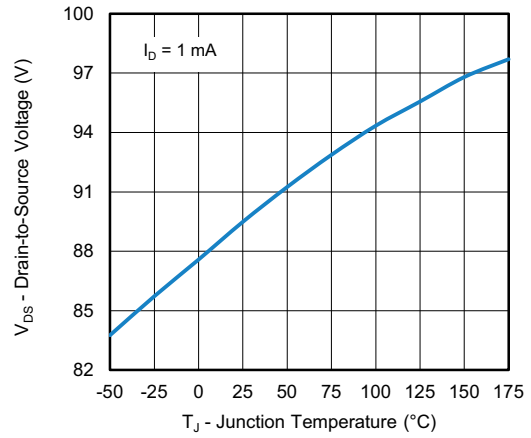

Drain Source Breakdown vs. Junction Temperature

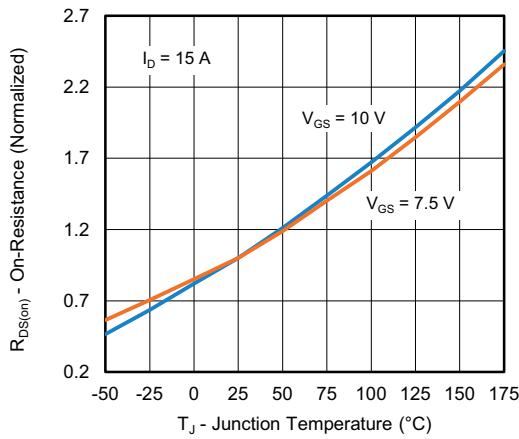

On-Resistance vs. Junction Temperature

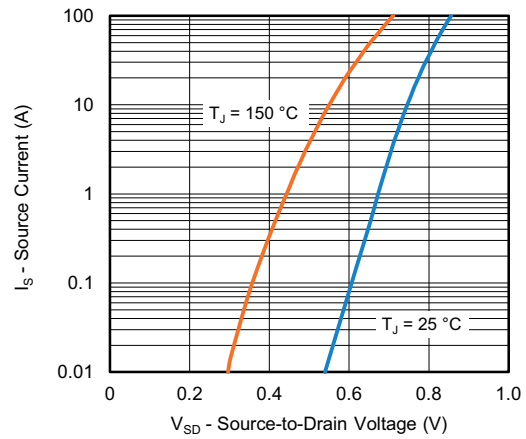

Source Drain Diode Forward Voltage

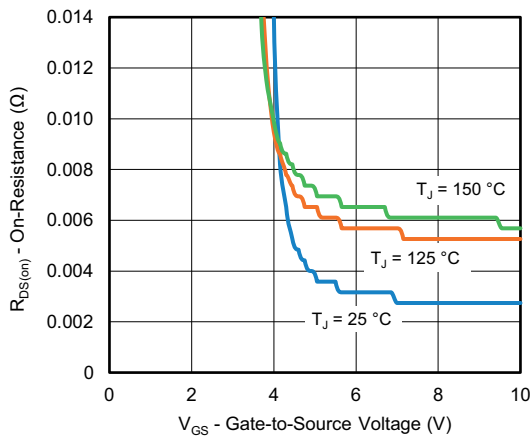

On-Resistance vs. Gate to Source Voltage



TYPICAL CHARACTERISTICS ($T_A = 25\text{ }^\circ\text{C}$, unless otherwise noted)

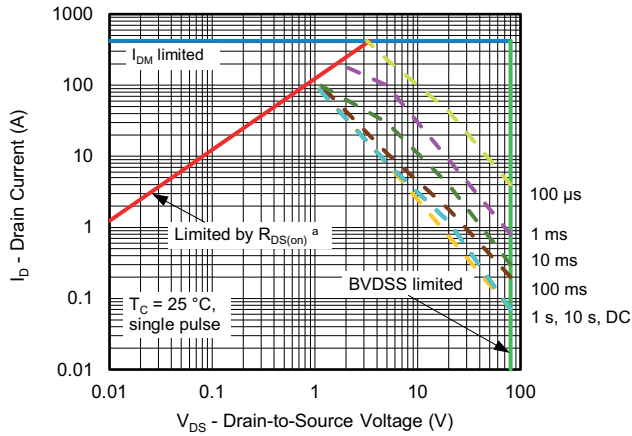

Safe Operating Area

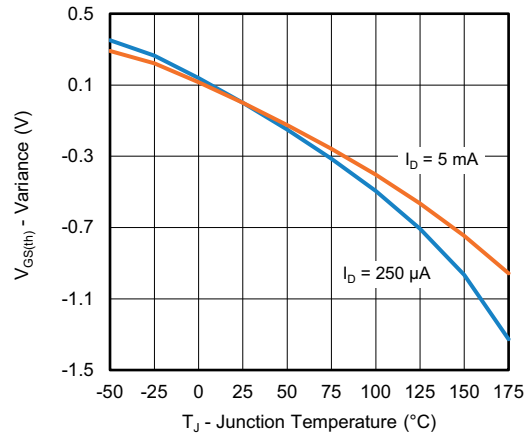

Threshold Voltage

Note

a. $V_{GS} >$ minimum V_{GS} at which $R_{DS(on)}$ is specified

TYPICAL CHARACTERISTICS ($T_A = 25\text{ }^\circ\text{C}$, unless otherwise noted)

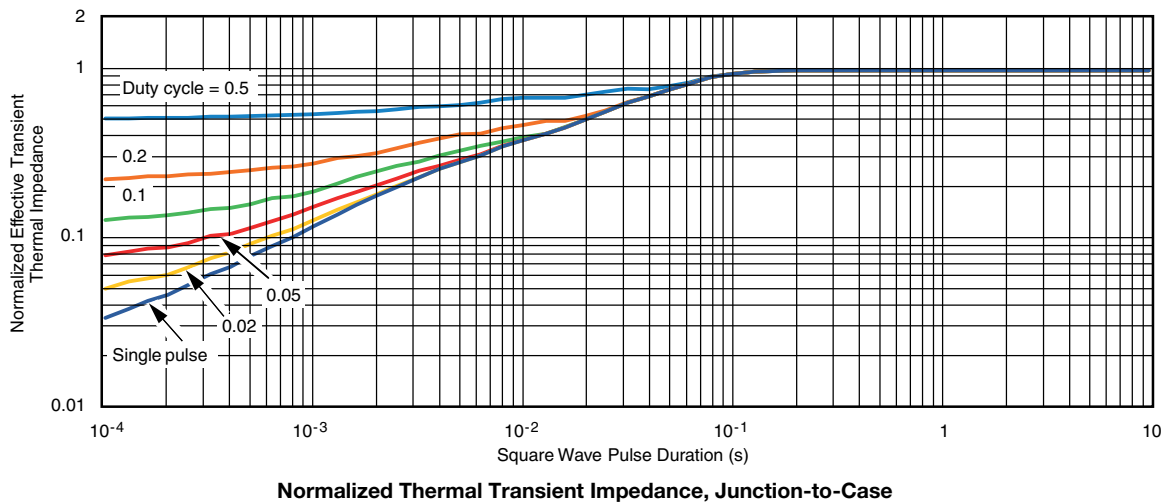
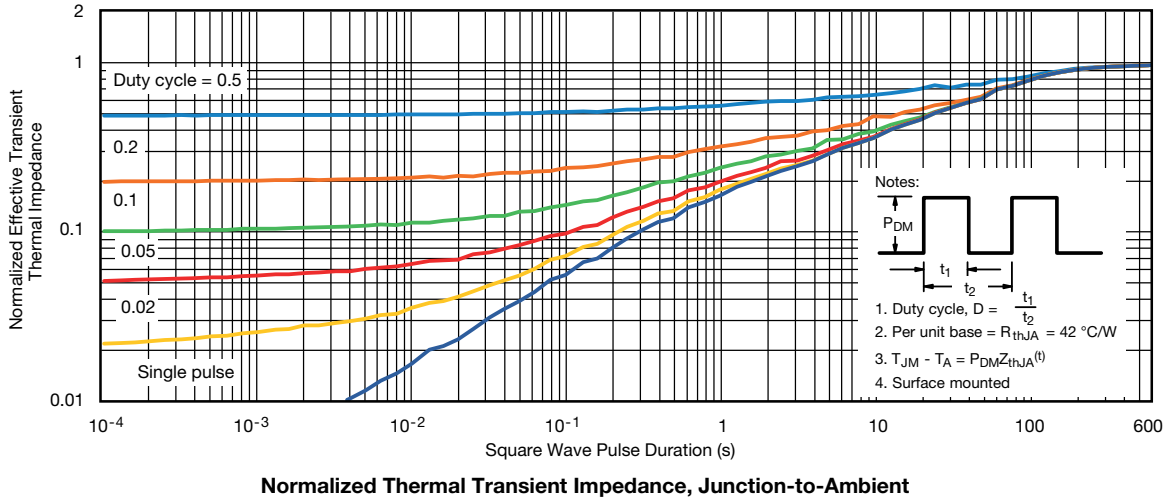

Note

- The characteristics shown in the two graphs
 - Normalized Transient Thermal Impedance Junction-to-Ambient ($25\text{ }^\circ\text{C}$)
 - Normalized Transient Thermal Impedance Junction-to-Case ($25\text{ }^\circ\text{C}$)
 are given for general guidelines only to enable the user to get a “ball park” indication of part capabilities. The data are extracted from single pulse transient thermal impedance characteristics which are developed from empirical measurements. The latter is valid for the part mounted on printed circuit board - FR4, size 1" x 1" x 0.062", double sided with 2 oz. copper, 100 % on both sides. The part capabilities can widely vary depending on actual application parameters and operating conditions

Vishay Siliconix maintains worldwide manufacturing capability. Products may be manufactured at one of several qualified locations. Reliability data for Silicon Technology and Package Reliability represent a composite of all qualified locations. For related documents such as package / tape drawings, part marking, and reliability data, see www.vishay.com/ppg?77297.



PowerPAK® SO-8L (PPKS08LWLA) Case Outline 3

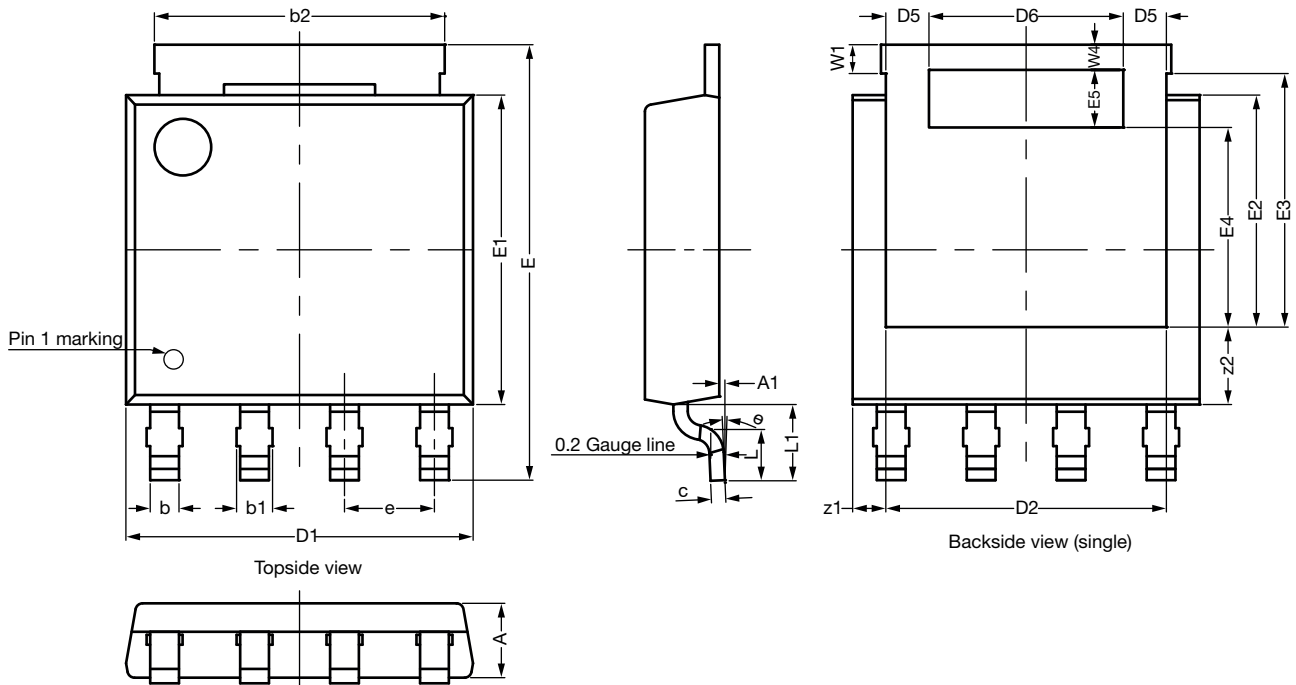

DIM.	MILLIMETERS			INCHES		
	MIN.	NOM.	MAX.	MIN.	NOM.	MAX.
A	1.00	1.05	1.10	0.039	0.041	0.043
A1	0.00	---	0.127	0.000	---	0.005
b	0.33	0.41	0.49	0.013	0.016	0.019
b1	0.43	0.51	0.59	0.017	0.020	0.023
b2	4.00	4.10	4.20	0.157	0.161	0.165
c	0.15	0.20	0.25	0.006	0.008	0.010
D1	4.80	4.90	5.00	0.189	0.193	0.197
D2	3.86	3.96	4.06	0.152	0.156	0.160
D5	0.51	0.61	0.71	0.020	0.024	0.028
D6	2.64	2.74	2.84	0.104	0.108	0.112
e	1.27 BSC			0.050 BSC		
E	6.05	6.15	6.25	0.238	0.242	0.246
E1	4.27	4.37	4.47	0.168	0.172	0.176
E2	3.18	3.28	3.38	0.125	0.129	0.133
E3	3.48	3.58	3.68	0.137	0.141	0.145
E4	2.72	2.82	2.92	0.107	0.111	0.115
E5	0.71	0.81	0.91	0.028	0.032	0.036
L	0.62	0.72	0.82	0.024	0.028	0.032
L1	0.92	1.07	1.22	0.036	0.042	0.048
W1	0.31	0.41	0.51	0.012	0.016	0.020
W4	0.31	0.36	0.41	0.012	0.014	0.016
z1	0.37	0.47	0.57	0.015	0.019	0.022
z2	0.99	1.09	1.19	0.039	0.043	0.047
θ	0°	---	5°	0°	---	5°

ECN: C23-1016-Rev. D, 18-Sep-2023
 DWG: 6067

Note

- Millimeter will govern



Recommended Land Pattern PowerPAK® SO-8L Single Short Ear

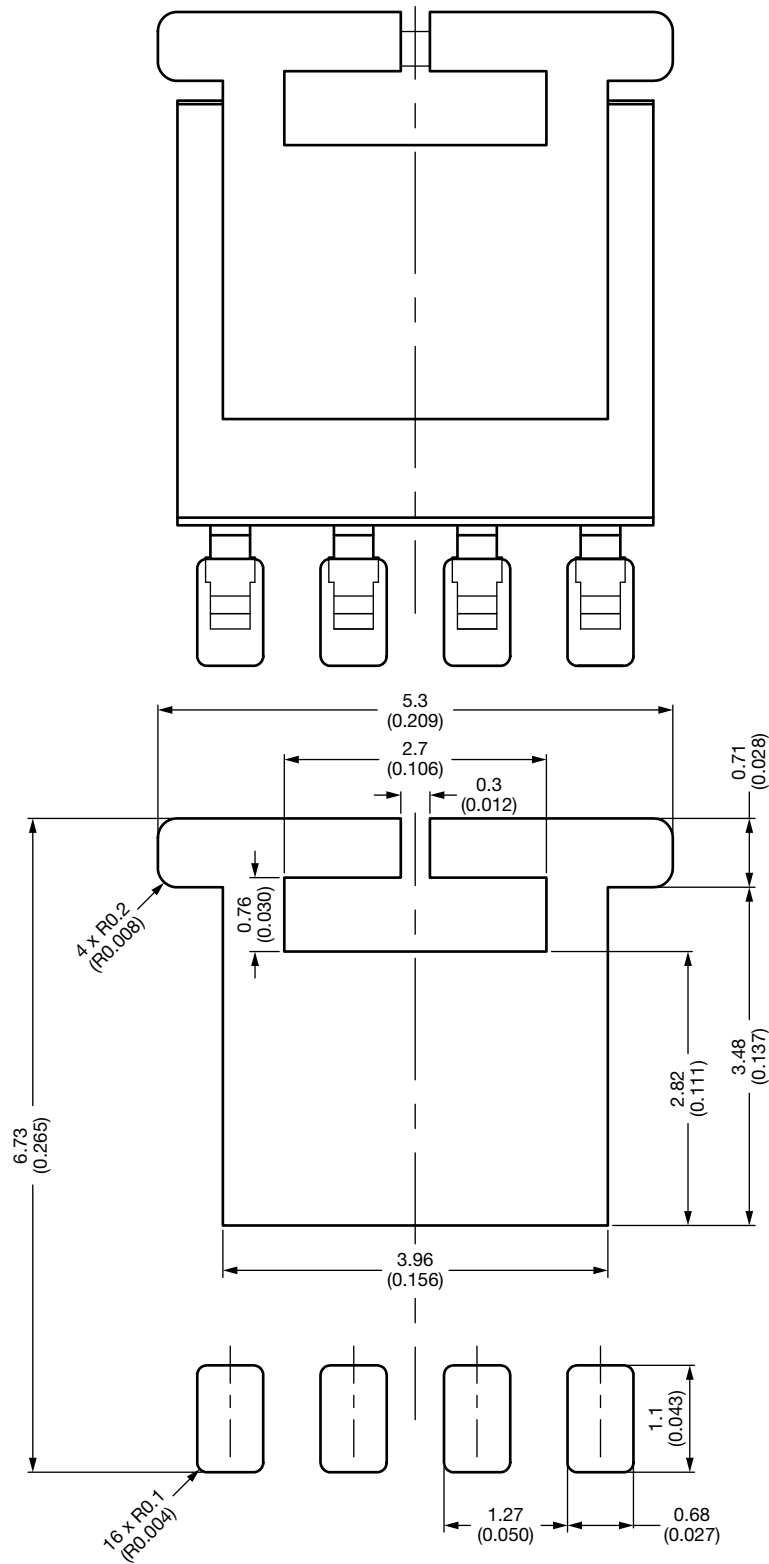

Dimensions in Millimeters (Inches)



Disclaimer

ALL PRODUCT, PRODUCT SPECIFICATIONS AND DATA ARE SUBJECT TO CHANGE WITHOUT NOTICE TO IMPROVE RELIABILITY, FUNCTION OR DESIGN OR OTHERWISE.

Vishay Intertechnology, Inc., its affiliates, agents, and employees, and all persons acting on its or their behalf (collectively, "Vishay"), disclaim any and all liability for any errors, inaccuracies or incompleteness contained in any datasheet or in any other disclosure relating to any product.

Vishay makes no warranty, representation or guarantee regarding the suitability of the products for any particular purpose or the continuing production of any product. To the maximum extent permitted by applicable law, Vishay disclaims (i) any and all liability arising out of the application or use of any product, (ii) any and all liability, including without limitation special, consequential or incidental damages, and (iii) any and all implied warranties, including warranties of fitness for particular purpose, non-infringement and merchantability.

Statements regarding the suitability of products for certain types of applications are based on Vishay's knowledge of typical requirements that are often placed on Vishay products in generic applications. Such statements are not binding statements about the suitability of products for a particular application. It is the customer's responsibility to validate that a particular product with the properties described in the product specification is suitable for use in a particular application. Parameters provided in datasheets and / or specifications may vary in different applications and performance may vary over time. All operating parameters, including typical parameters, must be validated for each customer application by the customer's technical experts. Product specifications do not expand or otherwise modify Vishay's terms and conditions of purchase, including but not limited to the warranty expressed therein.

Hyperlinks included in this datasheet may direct users to third-party websites. These links are provided as a convenience and for informational purposes only. Inclusion of these hyperlinks does not constitute an endorsement or an approval by Vishay of any of the products, services or opinions of the corporation, organization or individual associated with the third-party website. Vishay disclaims any and all liability and bears no responsibility for the accuracy, legality or content of the third-party website or for that of subsequent links.

Except as expressly indicated in writing, Vishay products are not designed for use in medical, life-saving, or life-sustaining applications or for any other application in which the failure of the Vishay product could result in personal injury or death. Customers using or selling Vishay products not expressly indicated for use in such applications do so at their own risk. Please contact authorized Vishay personnel to obtain written terms and conditions regarding products designed for such applications.

No license, express or implied, by estoppel or otherwise, to any intellectual property rights is granted by this document or by any conduct of Vishay. Product names and markings noted herein may be trademarks of their respective owners.