

SN74LVC2G53

SINGLE-POLE DOUBLE-THROW (SPDT) ANALOG SWITCH OR 2:1 ANALOG MULTIPLEXER/DEMULTIPLEXER

SCES324K – JULY 2001 – REVISED SEPTEMBER 2003

- Available in the Texas Instruments NanoStar™ and NanoFree™ Packages
- 1.65-V to 5.5-V V_{CC} Operation
- High On-Off Output Voltage Ratio
- High Degree of Linearity
- High Speed, Typically 0.5 ns ($V_{CC} = 3$ V, $C_L = 50$ pF)
- Low On-State Resistance, Typically $\approx 6.5 \Omega$ ($V_{CC} = 4.5$ V)
- Latch-Up Performance Exceeds 100 mA Per JESD 78, Class II
- ESD Protection Exceeds JESD 22
 - 2000-V Human-Body Model (A114-A)
 - 200-V Machine Model (A115-A)
 - 1000-V Charged-Device Model (C101)

DCT OR DCU PACKAGE
(TOP VIEW)

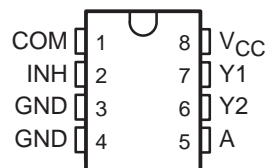

YEA, YEP, YZA, OR YZP PACKAGE
(BOTTOM VIEW)

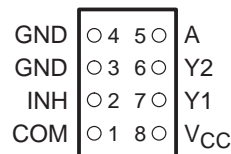

description/ordering information

This dual analog multiplexer/demultiplexer is designed for 1.65-V to 5.5-V V_{CC} operation.

The SN74LVC2G53 can handle both analog and digital signals. The device permits signals with amplitudes of up to 5.5 V (peak) to be transmitted in either direction.

NanoStar™ and NanoFree™ package technology is a major breakthrough in IC packaging concepts, using the die as the package.

Applications include signal gating, chopping, modulation or demodulation (modem), and signal multiplexing for analog-to-digital and digital-to-analog conversion systems.

ORDERING INFORMATION

T_A	PACKAGE†		ORDERABLE PART NUMBER	TOP-SIDE MARKING‡
–40°C to 85°C	NanoStar™ – WCSP (DSBGA) 0.17-mm Small Bump – YEA	Reel of 3000	SN74LVC2G53YEAR	_ _ _ C4 _
	NanoFree™ – WCSP (DSBGA) 0.17-mm Small Bump – YZA (Pb-free)		SN74LVC2G53YZAR	
	NanoStar™ – WCSP (DSBGA) 0.23-mm Large Bump – YEP		SN74LVC2G53YEPR	
	NanoFree™ – WCSP (DSBGA) 0.23-mm Large Bump – YZP (Pb-free)		SN74LVC2G53YZPR	
	SSOP – DCT	Reel of 3000	SN74LVC2G53DCTR	C53_ _ _
	VSSOP – DCU	Reel of 3000	SN74LVC2G53DCUR	C53_
	Reel of 250	SN74LVC2G53DCUT		

† Package drawings, standard packing quantities, thermal data, symbolization, and PCB design guidelines are available at www.ti.com/sc/package.

‡ DCT: The actual top-side marking has three additional characters that designate the year, month, and assembly/test site.

DCU: The actual top-side marking has one additional character that designates the assembly/test site.

YEA/YZA, YEP/YZP: The actual top-side marking has three preceding characters to denote year, month, and sequence code, and one following character to designate the assembly/test site. Pin 1 identifier indicates solder-bump composition (1 = SnPb, • = Pb-free).



Please be aware that an important notice concerning availability, standard warranty, and use in critical applications of Texas Instruments semiconductor products and disclaimers thereto appears at the end of this data sheet.

NanoStar and NanoFree are trademarks of Texas Instruments.

PRODUCTION DATA information is current as of publication date. Products conform to specifications per the terms of Texas Instruments standard warranty. Production processing does not necessarily include testing of all parameters.



POST OFFICE BOX 655303 • DALLAS, TEXAS 75265

Copyright © 2003, Texas Instruments Incorporated

SN74LVC2G53 SINGLE-POLE DOUBLE-THROW (SPDT) ANALOG SWITCH OR 2:1 ANALOG MULTIPLEXER/DEMULTIPLEXER

SCES324K – JULY 2001 – REVISED SEPTEMBER 2003

FUNCTION TABLE

CONTROL INPUTS		ON CHANNEL
INH	A	
L	L	Y1
L	H	Y2
H	X	None

logic diagram (positive logic)

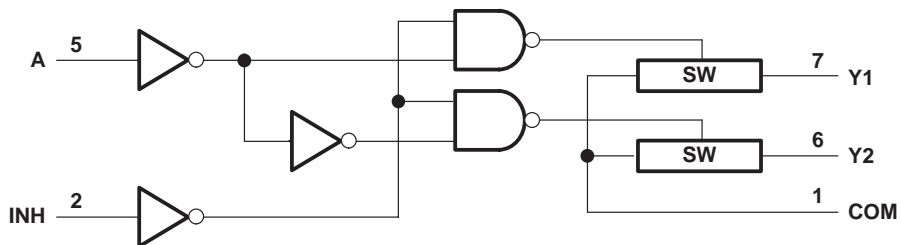

NOTE A: For simplicity, the test conditions shown in Figures 1 through 4 and 6 through 10 are for the demultiplexer configuration. Signals can be passed from COM to Y1 (Y2) or from Y1 (Y2) to COM.

simplified schematic, each switch (SW)

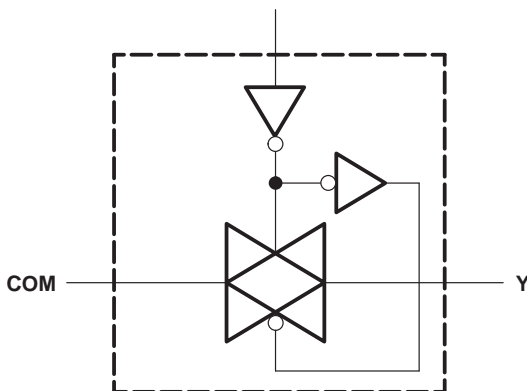

SN74LVC2G53

SINGLE-POLE DOUBLE-THROW (SPDT) ANALOG SWITCH OR 2:1 ANALOG MULTIPLEXER/DEMULTIPLEXER

SCES324K – JULY 2001 – REVISED SEPTEMBER 2003

absolute maximum ratings over operating free-air temperature range (unless otherwise noted)†

Supply voltage range, V_{CC} (see Note 1)	–0.5 V to 6.5 V
Input voltage range, V_I (see Notes 1 and 2)	–0.5 V to 6.5 V
Switch I/O voltage range, $V_{I/O}$ (see Notes 1, 2, and 3)	–0.5 V to $V_{CC} + 0.5$ V
Control input clamp current, I_{IK} ($V_I < 0$)	–50 mA
I/O port diode current, I_{IOK} ($V_{I/O} < 0$ or $V_{I/O} > V_{CC}$)	±50 mA
On-state switch current, I_T ($V_{I/O} = 0$ to V_{CC})	±50 mA
Continuous current through V_{CC} or GND	±100 mA
Package thermal impedance, θ_{JA} (see Note 4): DCT package	220°C/W
DCU package	227°C/W
YEA/YZA package	140°C/W
YEP/YZP package	102°C/W
Storage temperature range, T_{stg}	–65°C to 150°C

† Stresses beyond those listed under “absolute maximum ratings” may cause permanent damage to the device. These are stress ratings only, and functional operation of the device at these or any other conditions beyond those indicated under “recommended operating conditions” is not implied. Exposure to absolute-maximum-rated conditions for extended periods may affect device reliability.

- NOTES:
1. All voltages are with respect to ground unless otherwise specified.
 2. The input and output voltage ratings may be exceeded if the input and output clamp-current ratings are observed.
 3. This value is limited to 5.5 V maximum.
 4. The package thermal impedance is calculated in accordance with JESD 51-7.

recommended operating conditions (see Note 5)

		MIN	MAX	UNIT
V_{CC}	Supply voltage	1.65	5.5	V
$V_{I/O}$	I/O port voltage	0	V_{CC}	V
V_{IH}	High-level input voltage, control input	$V_{CC} = 1.65$ V to 1.95 V	$V_{CC} \times 0.65$	V
		$V_{CC} = 2.3$ V to 2.7 V	$V_{CC} \times 0.7$	
		$V_{CC} = 3$ V to 3.6 V	$V_{CC} \times 0.7$	
		$V_{CC} = 4.5$ V to 5.5 V	$V_{CC} \times 0.7$	
V_{IL}	Low-level input voltage, control input	$V_{CC} = 1.65$ V to 1.95 V	$V_{CC} \times 0.35$	V
		$V_{CC} = 2.3$ V to 2.7 V	$V_{CC} \times 0.3$	
		$V_{CC} = 3$ V to 3.6 V	$V_{CC} \times 0.3$	
		$V_{CC} = 4.5$ V to 5.5 V	$V_{CC} \times 0.3$	
V_I	Control input voltage	0	5.5	V
$\Delta t/\Delta v$	Input transition rise/fall time	$V_{CC} = 1.65$ V to 1.95 V	20	ns/V
		$V_{CC} = 2.3$ V to 2.7 V	20	
		$V_{CC} = 3$ V to 3.6 V	10	
		$V_{CC} = 4.5$ V to 5.5 V	10	
T_A	Operating free-air temperature	–40	85	°C

NOTE 5: All unused inputs of the device must be held at V_{CC} or GND to ensure proper device operation. Refer to the TI application report, *Implications of Slow or Floating CMOS Inputs*, literature number SCBA004.



SN74LVC2G53

SINGLE-POLE DOUBLE-THROW (SPDT) ANALOG SWITCH OR 2:1 ANALOG MULTIPLEXER/DEMULTIPLEXER

SCES324K – JULY 2001 – REVISED SEPTEMBER 2003

electrical characteristics over recommended operating free-air temperature range (unless otherwise noted)

PARAMETER		TEST CONDITIONS	V _{CC}	MIN	TYP†	MAX	UNIT
r _{on}	On-state switch resistance	V _I = V _{CC} or GND, V _{INH} = V _{IL} (see Figures 1 and 2)	I _S = 4 mA	1.65 V	13	30	Ω
			I _S = 8 mA	2.3 V	10	20	
			I _S = 24 mA	3 V	8.5	17	
			I _S = 32 mA	4.5 V	6.5	13	
r _{on(p)}	Peak on-state resistance	V _I = V _{CC} to GND, V _{INH} = V _{IL} (see Figures 1 and 2)	I _S = 4 mA	1.65 V	86.5	120	Ω
			I _S = 8 mA	2.3 V	23	30	
			I _S = 24 mA	3 V	13	20	
			I _S = 32 mA	4.5 V	8	15	
Δr _{on}	Difference of on-state resistance between switches	V _I = V _{CC} to GND, V _C = V _{IH} (see Figures 1 and 2)	I _S = 4 mA	1.65 V		7	Ω
			I _S = 8 mA	2.3 V		5	
			I _S = 24 mA	3 V		3	
			I _S = 32 mA	4.5 V		2	
I _{S(off)}	Off-state switch leakage current	V _I = V _{CC} and V _O = GND or V _I = GND and V _O = V _{CC} , V _{INH} = V _{IH} (see Figure 3)	5.5 V			±1 ±0.1†	μA
I _{S(on)}	On-state switch leakage current	V _I = V _{CC} or GND, V _{INH} = V _{IL} , V _O = Open (see Figure 4)	5.5 V			±1 ±0.1†	μA
I _I	Control input current	V _C = V _{CC} or GND	5.5 V			±1	μA
						±0.1†	μA
I _{CC}	Supply current	V _C = V _{CC} or GND	5.5 V			1	μA
ΔI _{CC}	Supply-current change	V _C = V _{CC} – 0.6 V	5.5 V			500	μA
C _{ic}	Control input capacitance		5 V			3.5	pF
C _{io(off)}	Switch input/output capacitance	Y	5 V			6.5	pF
		COM				10	
C _{io(on)}	Switch input/output capacitance		5 V			19.5	pF

† T_A = 25°C

switching characteristics over recommended operating free-air temperature range (unless otherwise noted) (see Figure 5)

PARAMETER	FROM (INPUT)	TO (OUTPUT)	V _{CC} = 1.8 V ± 0.15 V		V _{CC} = 2.5 V ± 0.2 V		V _{CC} = 3.3 V ± 0.3 V		V _{CC} = 5 V ± 0.5 V		UNIT
			MIN	MAX	MIN	MAX	MIN	MAX	MIN	MAX	
t _{pd} ‡	COM or Y	Y or COM		2		1.2		0.8		0.6	ns
t _{en} §	INH	COM or Y	3.3	9	2.5	6.1	2.2	5.4	1.8	4.5	ns
t _{dis} ¶			3.2	10.9	2.3	8.3	2.3	8.1	1.6	8	
t _{en} §	A	COM or Y	2.9	10.3	2.1	7.2	1.9	5.8	1.3	5.4	ns
t _{dis} ¶			2.1	9.4	1.4	7.9	1.1	7.2	1	5	

‡ t_{PLH} and t_{PHL} are the same as t_{pd}. The propagation delay is the calculated RC time constant of the typical on-state resistance of the switch and the specified load capacitance, when driven by an ideal voltage source (zero output impedance).

§ t_{PZL} and t_{PZH} are the same as t_{en}.

¶ t_{PLZ} and t_{PHZ} are the same as t_{dis}.



SN74LVC2G53

SINGLE-POLE DOUBLE-THROW (SPDT) ANALOG SWITCH OR 2:1 ANALOG MULTIPLEXER/DEMULTIPLEXER

SCES324K – JULY 2001 – REVISED SEPTEMBER 2003

analog switch characteristics, $T_A = 25^\circ\text{C}$

PARAMETER	FROM (INPUT)	TO (OUTPUT)	TEST CONDITIONS	V _{CC}	TYP	UNIT
Frequency response [†] (switch on)	COM or Y	Y or COM	$C_L = 50\text{ pF}$, $R_L = 600\ \Omega$, $f_{in} = \text{sine wave}$ (see Figure 6)	1.65 V	35	MHz
				2.3 V	120	
				3 V	190	
				4.5 V	215	
			$C_L = 5\text{ pF}$, $R_L = 50\ \Omega$, $f_{in} = \text{sine wave}$ (see Figure 6)	1.65 V	>300	
				2.3 V	>300	
				3 V	>300	
				4.5 V	>300	
Crosstalk [‡] (between switches)	COM or Y	Y or COM	$C_L = 50\text{ pF}$, $R_L = 600\ \Omega$, $f_{in} = 1\text{ MHz}$ (sine wave) (see Figure 7)	1.65 V	-58	dB
				2.3 V	-58	
				3 V	-58	
				4.5 V	-58	
			$C_L = 5\text{ pF}$, $R_L = 50\ \Omega$, $f_{in} = 1\text{ MHz}$ (sine wave) (see Figure 7)	1.65 V	-42	
				2.3 V	-42	
				3 V	-42	
				4.5 V	-42	
Crosstalk (control input to signal output)	INH	COM or Y	$C_L = 50\text{ pF}$, $R_L = 600\ \Omega$, $f_{in} = 1\text{ MHz}$ (square wave) (see Figure 8)	1.65 V	35	mV
				2.3 V	50	
				3 V	70	
				4.5 V	100	
Feed-through attenuation [‡] (switch off)	COM or Y	Y or COM	$C_L = 50\text{ pF}$, $R_L = 600\ \Omega$, $f_{in} = 1\text{ MHz}$ (sine wave) (see Figure 9)	1.65 V	-60	dB
				2.3 V	-60	
				3 V	-60	
				4.5 V	-60	
			$C_L = 5\text{ pF}$, $R_L = 50\ \Omega$, $f_{in} = 1\text{ MHz}$ (sine wave) (see Figure 9)	1.65 V	-50	
				2.3 V	-50	
				3 V	-50	
				4.5 V	-50	
Sine-wave distortion	COM or Y	Y or COM	$C_L = 50\text{ pF}$, $R_L = 10\text{ k}\Omega$, $f_{in} = 1\text{ kHz}$ (sine wave) (see Figure 10)	1.65 V	0.1	%
				2.3 V	0.025	
				3 V	0.015	
				4.5 V	0.01	
			$C_L = 50\text{ pF}$, $R_L = 10\text{ k}\Omega$, $f_{in} = 10\text{ kHz}$ (sine wave) (see Figure 10)	1.65 V	0.15	
				2.3 V	0.025	
				3 V	0.015	
				4.5 V	0.01	

[†] Adjust f_{in} voltage to obtain 0 dBm at output. Increase f_{in} frequency until dB meter reads -3 dB.

[‡] Adjust f_{in} voltage to obtain 0 dBm at input.

operating characteristics, $T_A = 25^\circ\text{C}$

PARAMETER	TEST CONDITIONS	V _{CC} = 1.8 V	V _{CC} = 2.5 V	V _{CC} = 3.3 V	V _{CC} = 5 V	UNIT
		TYP	TYP	TYP	TYP	
C _{pd} Power dissipation capacitance	$C_L = 50\text{ pF}$, $f = 10\text{ MHz}$	9	10	10	12	pF



SN74LVC2G53
SINGLE-POLE DOUBLE-THROW (SPDT) ANALOG SWITCH OR
2:1 ANALOG MULTIPLEXER/DEMULTIPLEXER

SCES324K – JULY 2001 – REVISED SEPTEMBER 2003

PARAMETER MEASUREMENT INFORMATION

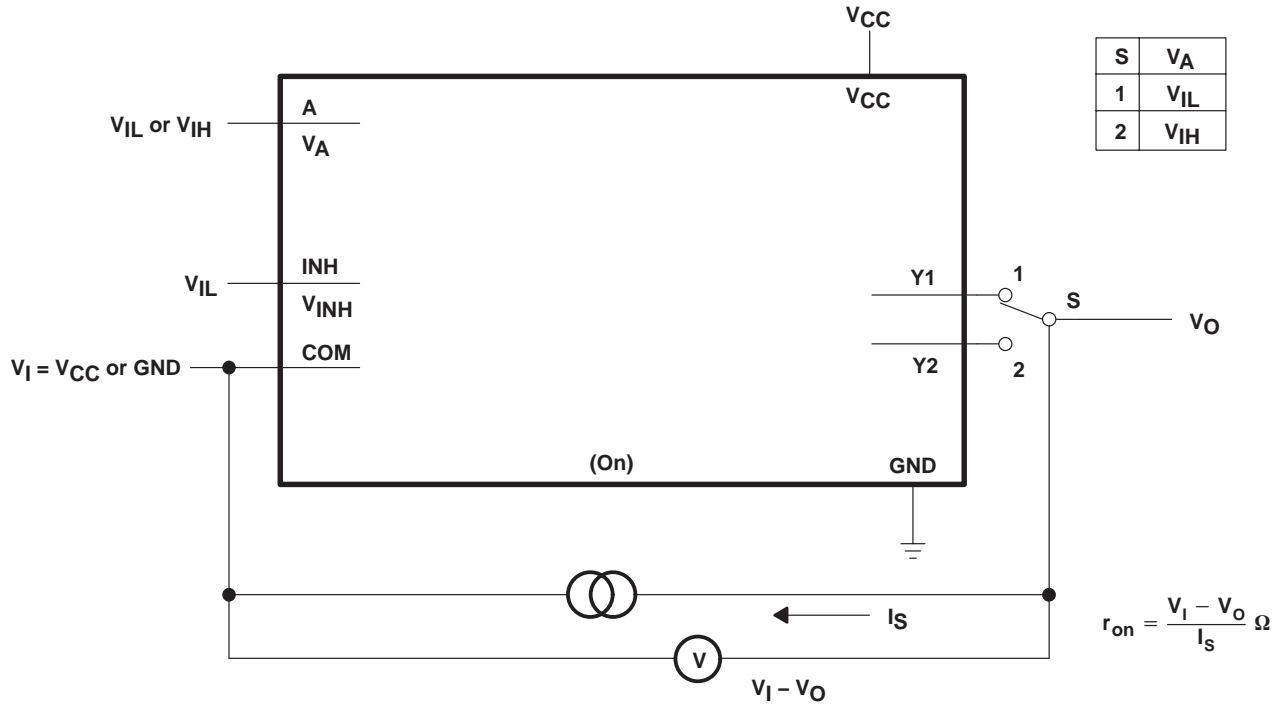

Figure 1. On-State Resistance Test Circuit

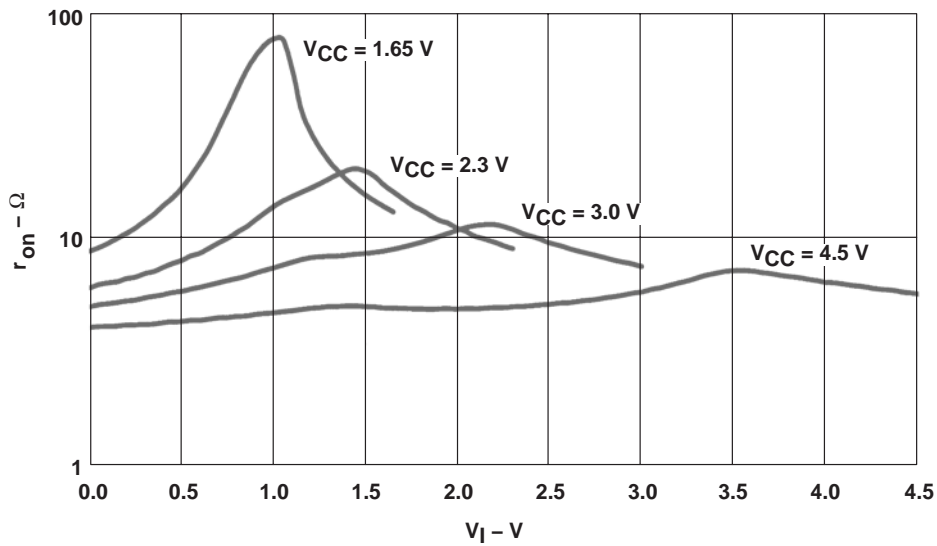

Figure 2. Typical r_{on} as a Function of Input Voltage (V_1) for $V_1 = 0$ to V_{CC}

SN74LVC2G53
SINGLE-POLE DOUBLE-THROW (SPDT) ANALOG SWITCH OR
2:1 ANALOG MULTIPLEXER/DEMULTIPLEXER

SCES324K – JULY 2001 – REVISED SEPTEMBER 2003

PARAMETER MEASUREMENT INFORMATION

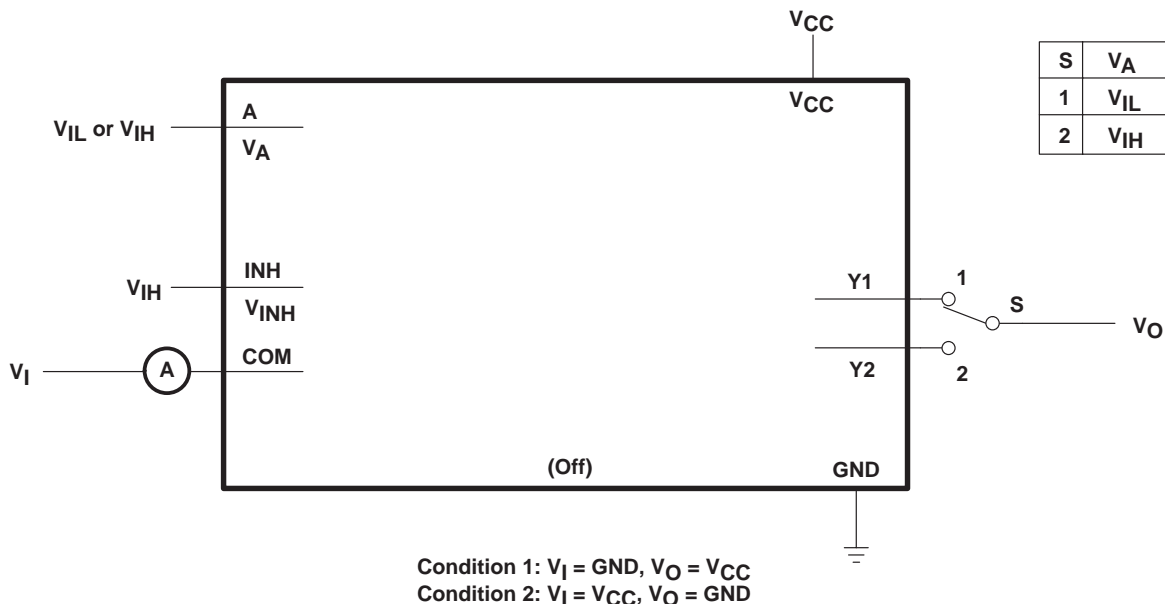

Figure 3. Off-State Switch Leakage-Current Test Circuit

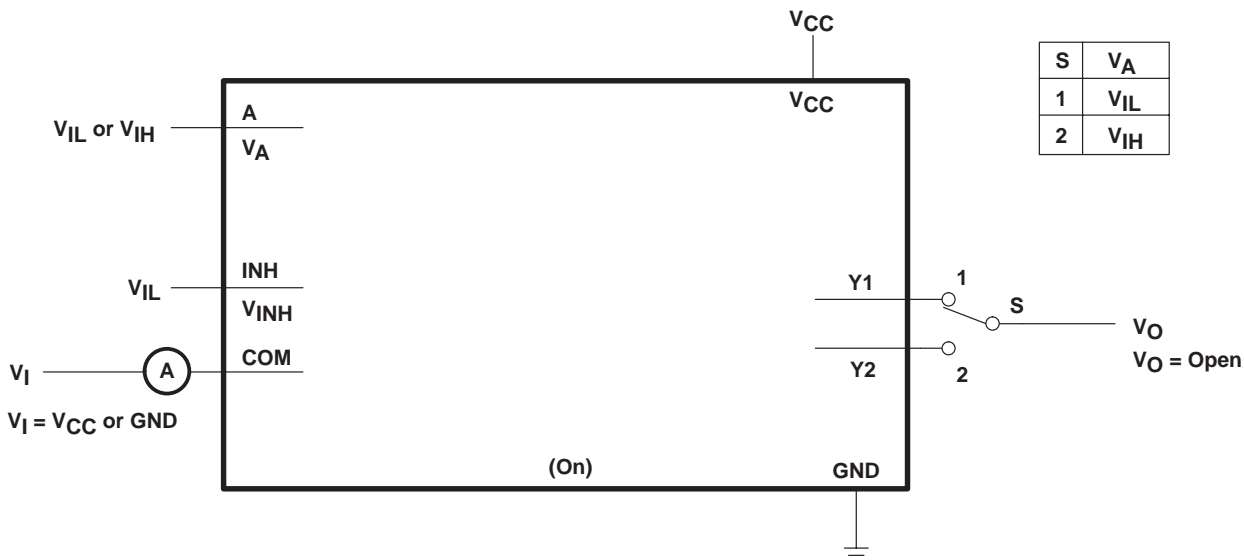
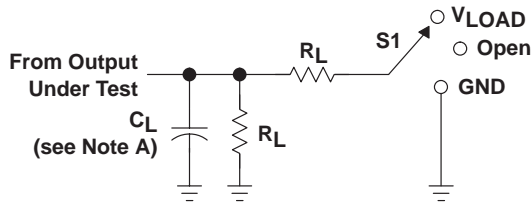

Figure 4. On-State Switch Leakage-Current Test Circuit

SN74LVC2G53 SINGLE-POLE DOUBLE-THROW (SPDT) ANALOG SWITCH OR 2:1 ANALOG MULTIPLEXER/DEMULTIPLEXER

SCES324K – JULY 2001 – REVISED SEPTEMBER 2003

PARAMETER MEASUREMENT INFORMATION



LOAD CIRCUIT

TEST	S1
t_{PLH}/t_{PHL}	Open
t_{PLZ}/t_{PZL}	V_{LOAD}
t_{PHZ}/t_{PZH}	GND

V_{CC}	INPUTS		V_M	V_{LOAD}	C_L	R_L	V_{Δ}
	V_I	t_r/t_f					
$1.8\text{ V} \pm 0.15\text{ V}$	V_{CC}	$\leq 2\text{ ns}$	$V_{CC}/2$	$2 \times V_{CC}$	30 pF	1 k Ω	0.15 V
$2.5\text{ V} \pm 0.2\text{ V}$	V_{CC}	$\leq 2\text{ ns}$	$V_{CC}/2$	$2 \times V_{CC}$	30 pF	500 Ω	0.15 V
$3.3\text{ V} \pm 0.3\text{ V}$	V_{CC}	$\leq 2.5\text{ ns}$	$V_{CC}/2$	$2 \times V_{CC}$	50 pF	500 Ω	0.3 V
$5\text{ V} \pm 0.5\text{ V}$	V_{CC}	$\leq 2.5\text{ ns}$	$V_{CC}/2$	$2 \times V_{CC}$	50 pF	500 Ω	0.3 V

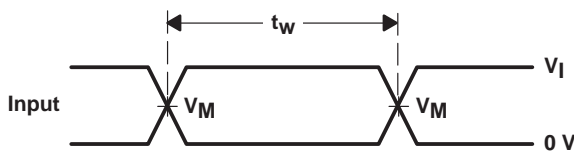

VOLTAGE WAVEFORMS
PULSE DURATION

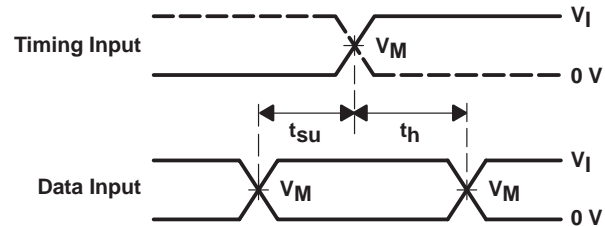

VOLTAGE WAVEFORMS
SETUP AND HOLD TIMES

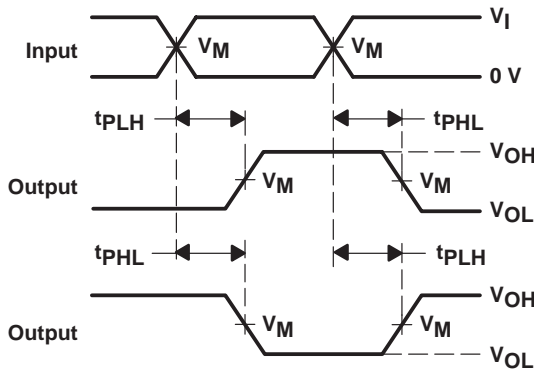

VOLTAGE WAVEFORMS
PROPAGATION DELAY TIMES
INVERTING AND NONINVERTING OUTPUTS

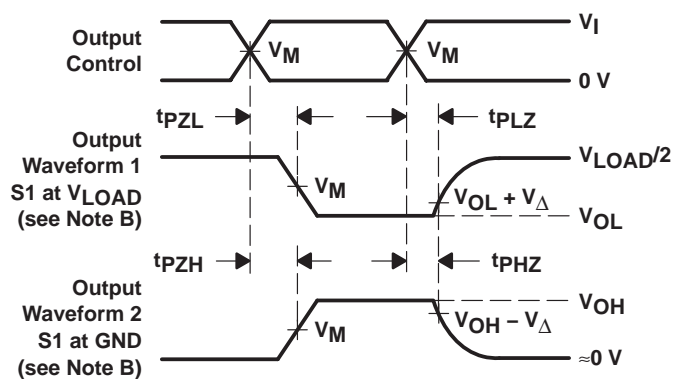

VOLTAGE WAVEFORMS
ENABLE AND DISABLE TIMES
LOW- AND HIGH-LEVEL ENABLING

- NOTES:
- C_L includes probe and jig capacitance.
 - Waveform 1 is for an output with internal conditions such that the output is low except when disabled by the output control. Waveform 2 is for an output with internal conditions such that the output is high except when disabled by the output control.
 - All input pulses are supplied by generators having the following characteristics: $PRR \leq 10\text{ MHz}$, $Z_O = 50\ \Omega$.
 - The outputs are measured one at a time with one transition per measurement.
 - t_{PLZ} and t_{PHZ} are the same as t_{dis} .
 - t_{PZL} and t_{PZH} are the same as t_{en} .
 - t_{PLH} and t_{PHL} are the same as t_{pd} .
 - All parameters and waveforms are not applicable to all devices.

Figure 5. Load Circuit and Voltage Waveforms

SN74LVC2G53 SINGLE-POLE DOUBLE-THROW (SPDT) ANALOG SWITCH OR 2:1 ANALOG MULTIPLEXER/DEMULTIPLEXER

SCES324K – JULY 2001 – REVISED SEPTEMBER 2003

PARAMETER MEASUREMENT INFORMATION

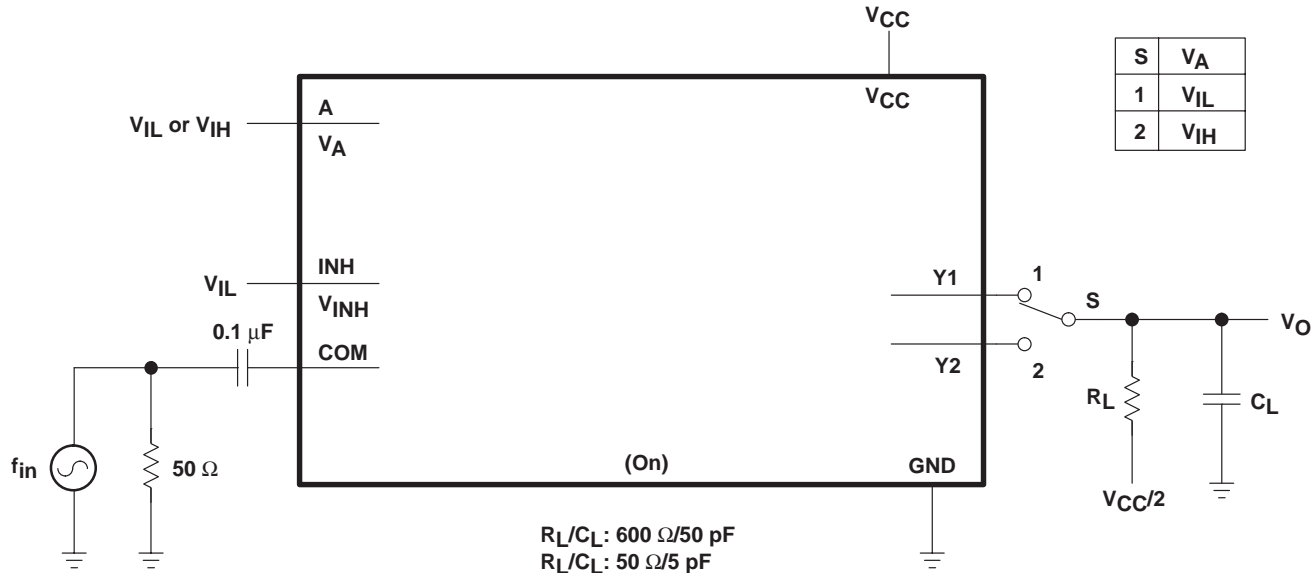

Figure 6. Frequency Response (Switch On)

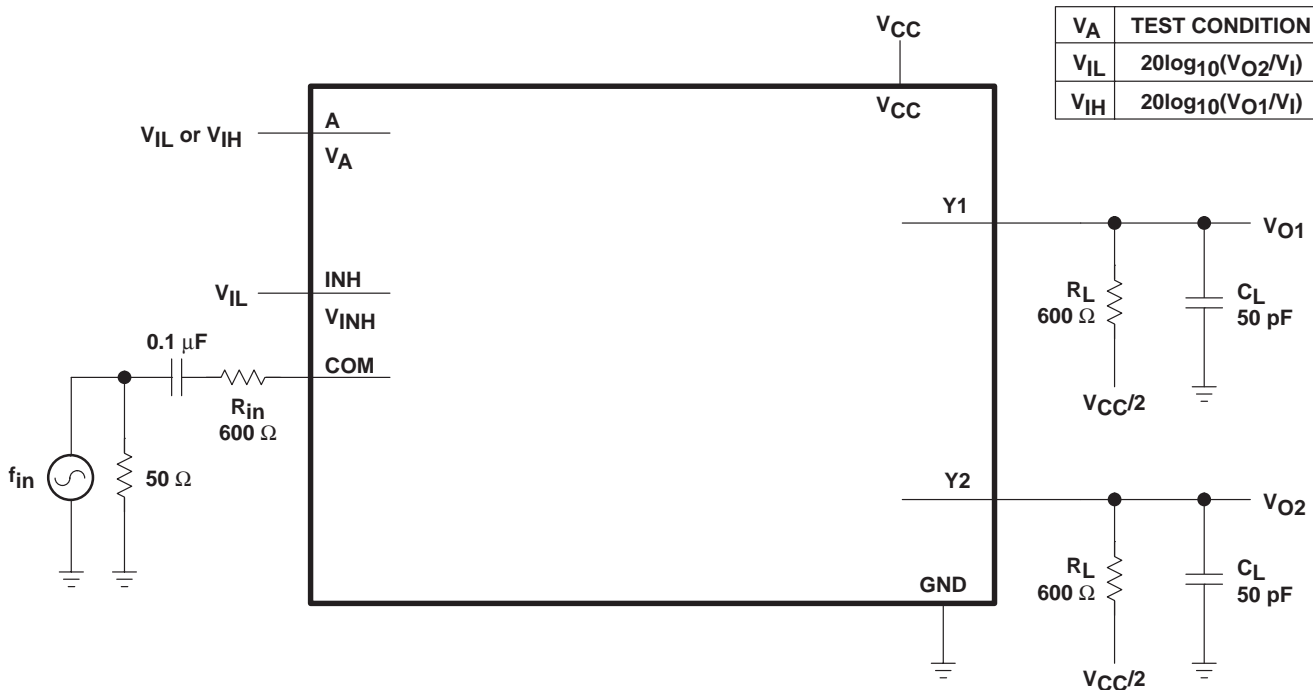

Figure 7. Crosstalk (Between Switches)

SN74LVC2G53
SINGLE-POLE DOUBLE-THROW (SPDT) ANALOG SWITCH OR
2:1 ANALOG MULTIPLEXER/DEMULTIPLEXER

SCES324K – JULY 2001 – REVISED SEPTEMBER 2003

PARAMETER MEASUREMENT INFORMATION

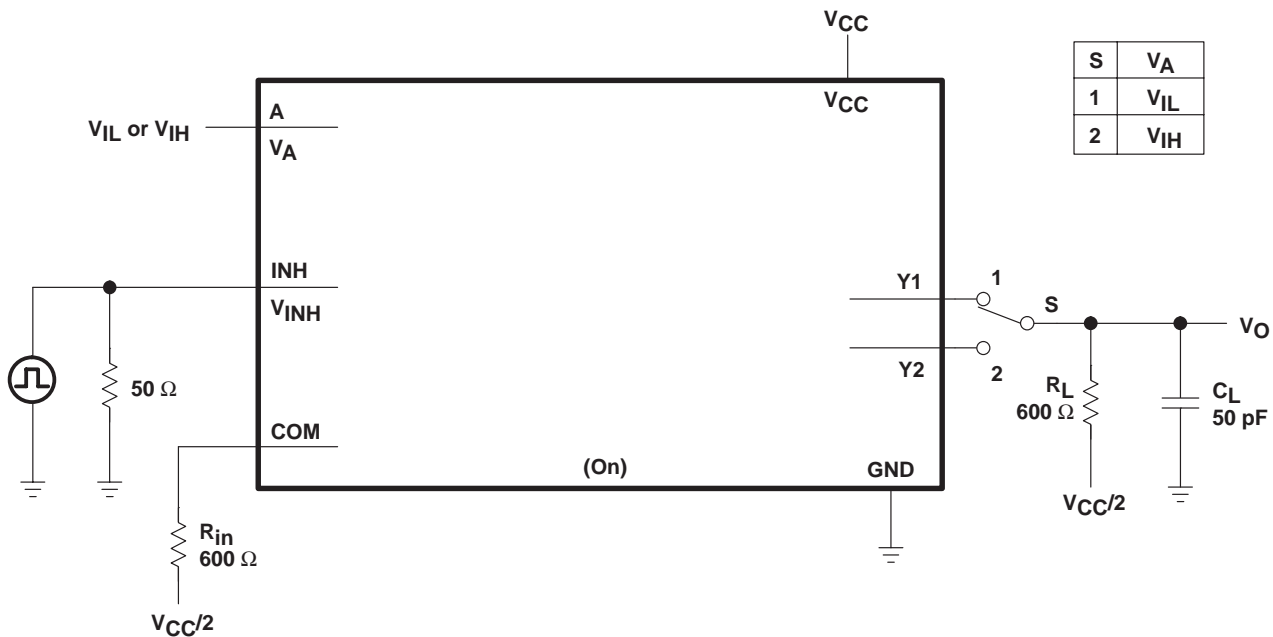

Figure 8. Crosstalk (Control Input, Switch Output)

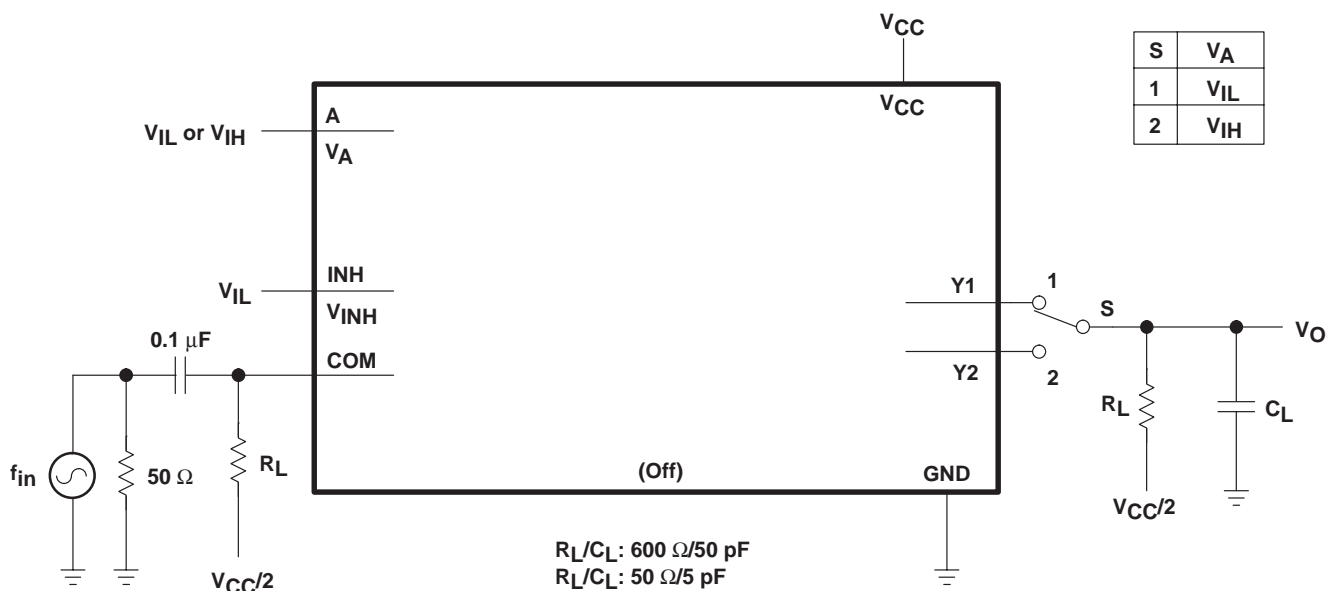

Figure 9. Feed Through (Switch Off)

SN74LVC2G53

SINGLE-POLE DOUBLE-THROW (SPDT) ANALOG SWITCH OR 2:1 ANALOG MULTIPLEXER/DEMULTIPLEXER

SCES324K – JULY 2001 – REVISED SEPTEMBER 2003

PARAMETER MEASUREMENT INFORMATION

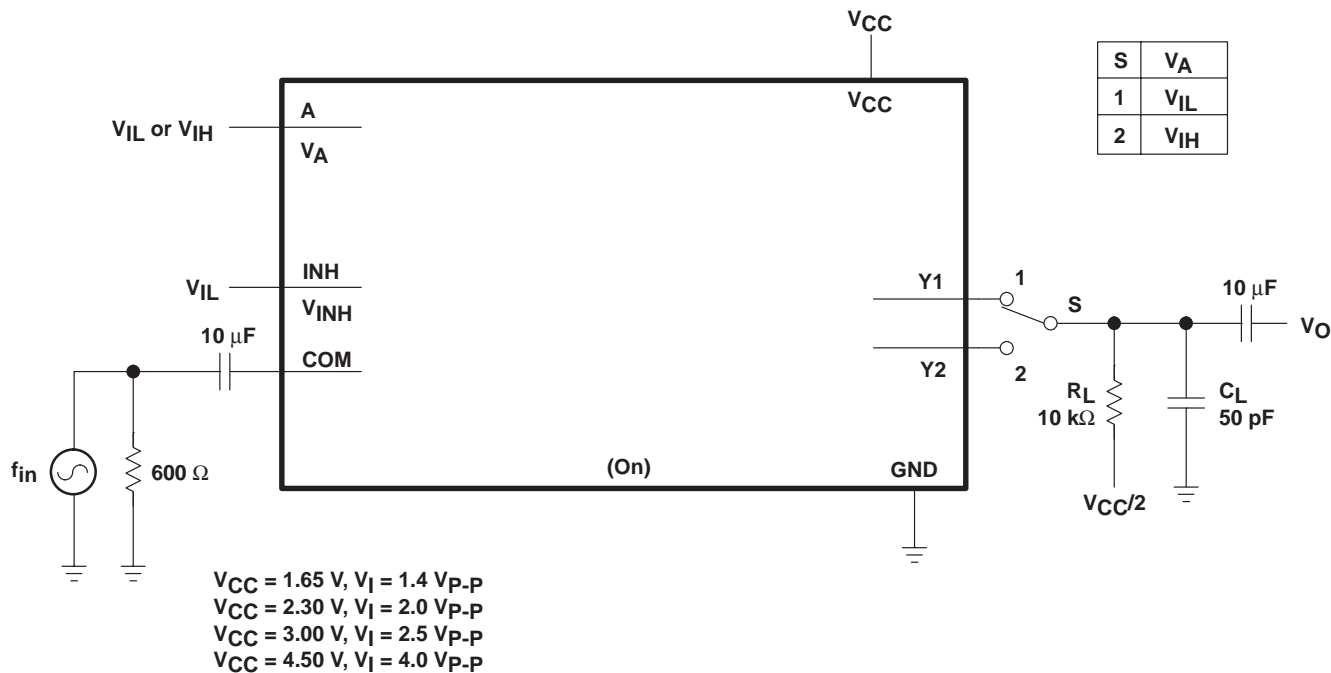

Figure 10. Sine-Wave Distortion

DCT (R-PDSO-G8)

PLASTIC SMALL-OUTLINE PACKAGE



- NOTES: A. All linear dimensions are in millimeters.
 B. This drawing is subject to change without notice.
 C. Body dimensions do not include mold flash or protrusion
 D. Falls within JEDEC MO-187 variation DA.

DCU (R-PDSO-G8)

PLASTIC SMALL-OUTLINE PACKAGE (DIE DOWN)

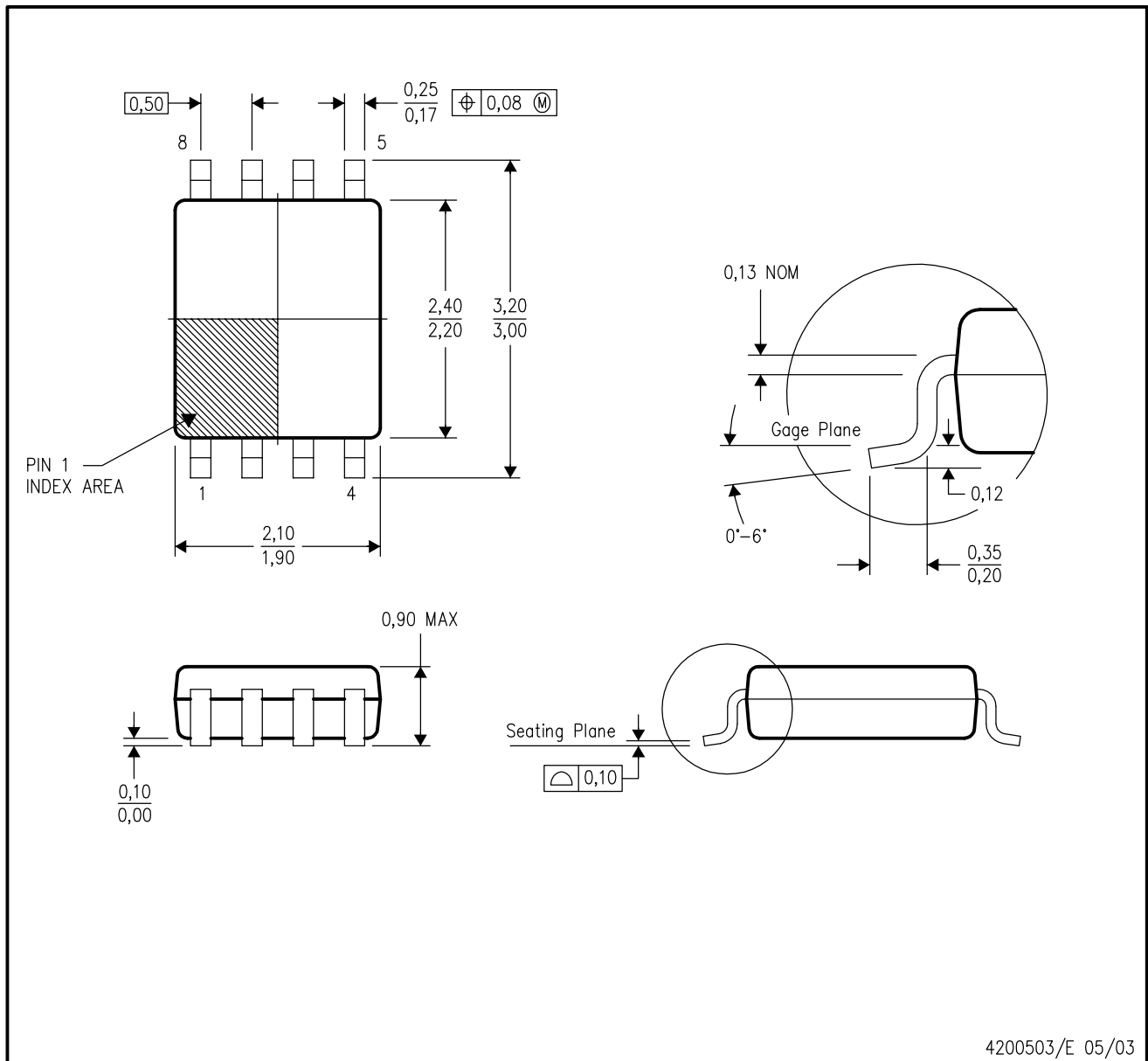

- NOTES:
- All linear dimensions are in millimeters.
 - This drawing is subject to change without notice.
 - Body dimensions do not include mold flash or protrusion.
 - Falls within JEDEC MO-187 variation CA.

YEA (R-XBGA-N8)

DIE-SIZE BALL GRID ARRAY

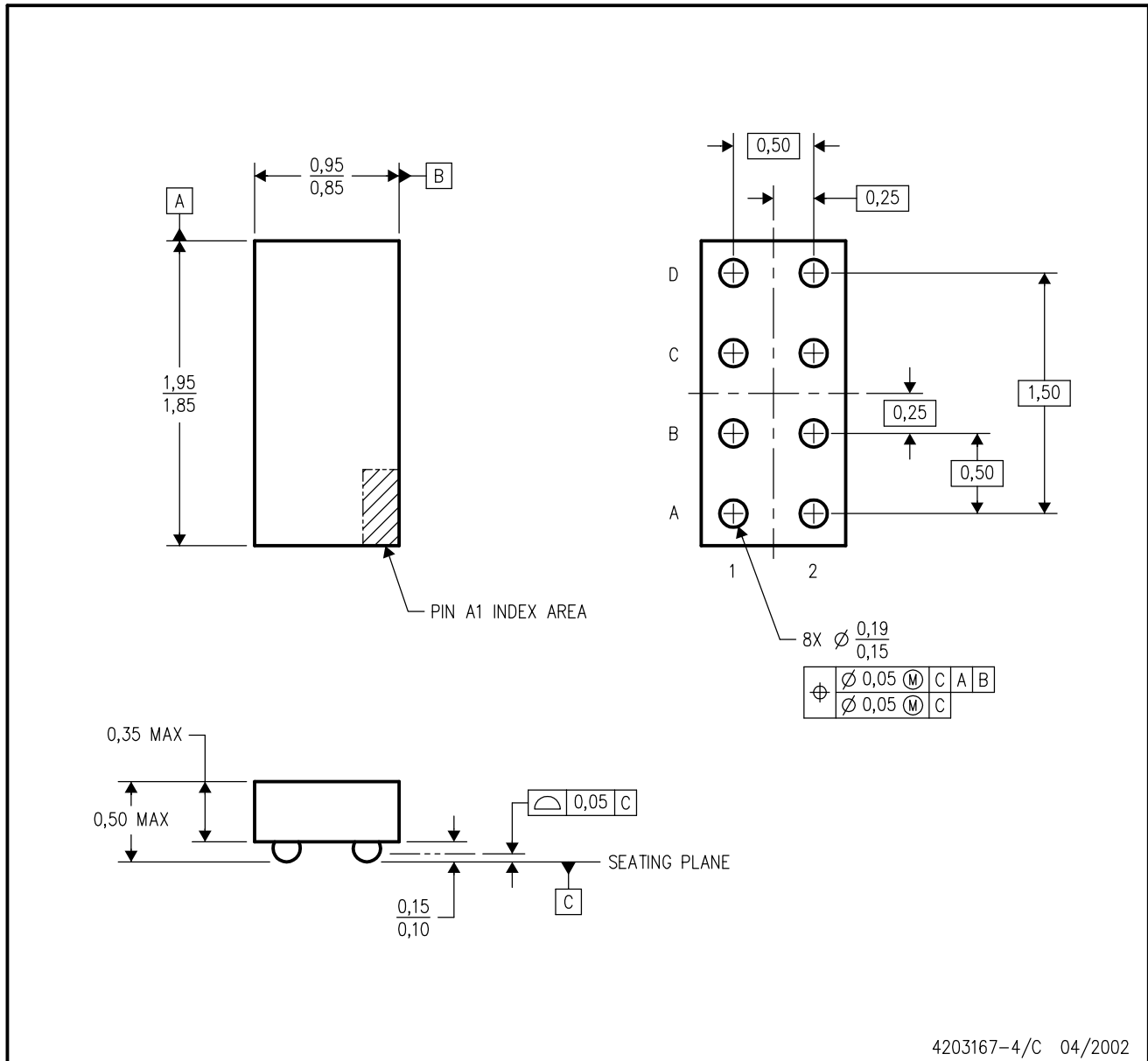

- NOTES:
- A. All linear dimensions are in millimeters.
 - B. This drawing is subject to change without notice.
 - C. NanoStar™ package configuration.
 - D. Package complies to JEDEC MO-211 variation EB.
 - E. This package is tin-lead (SnPb). Refer to the 8 YZA package (drawing 4204151) for lead-free.

NanoStar is a trademark of Texas Instruments.

YZA (R-XBGA-N8)

DIE-SIZE BALL GRID ARRAY

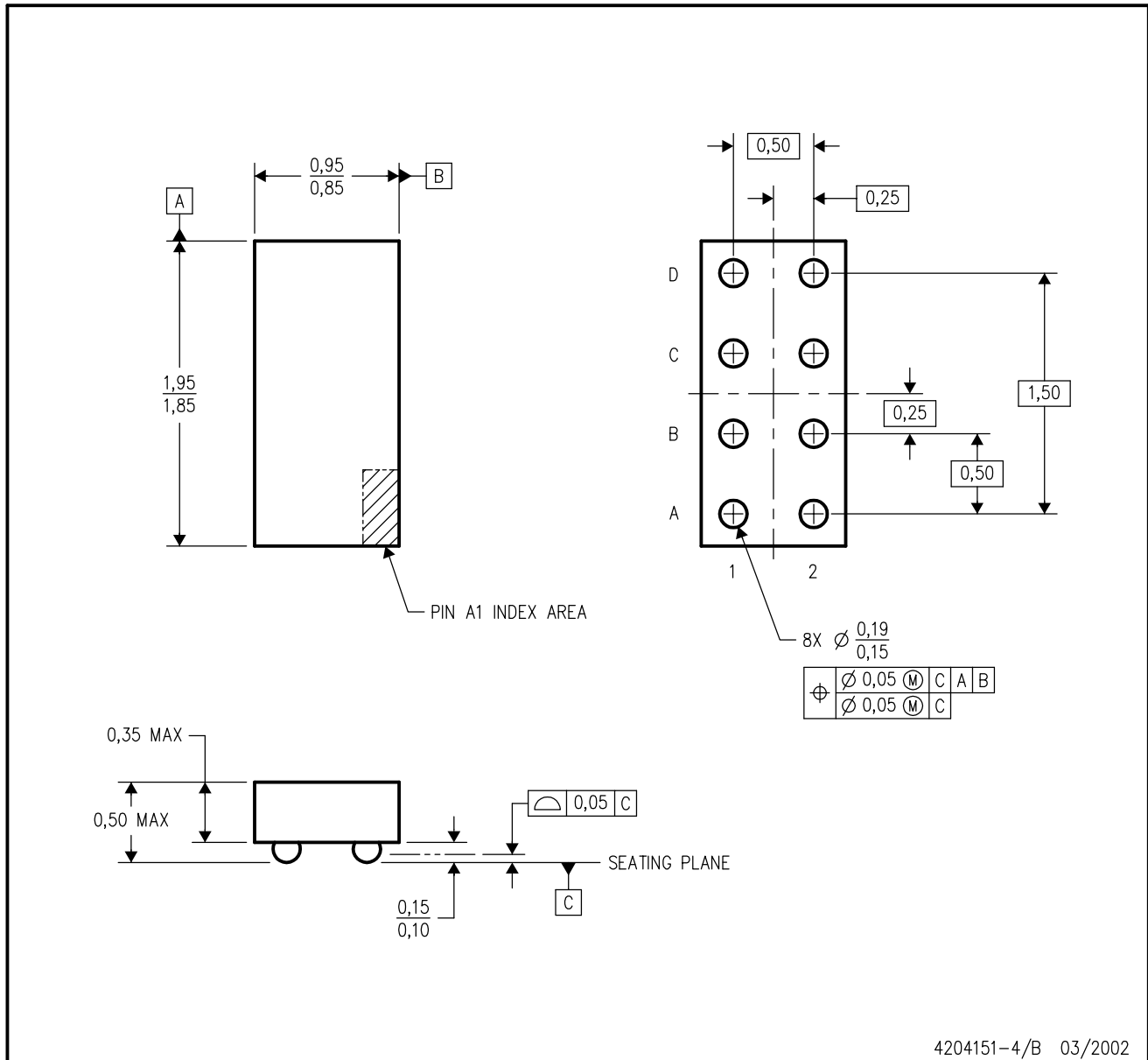

- NOTES:
- A. All linear dimensions are in millimeters.
 - B. This drawing is subject to change without notice.
 - C. NanoFree™ package configuration.
 - D. Package complies to JEDEC MO-211 variation EB.
 - E. This package is lead-free. Refer to the 8 YEA package (drawing 4203167) for tin-lead (SnPb).

NanoFree is a trademark of Texas Instruments.

YZP (R-XBGA-N8)

DIE-SIZE BALL GRID ARRAY

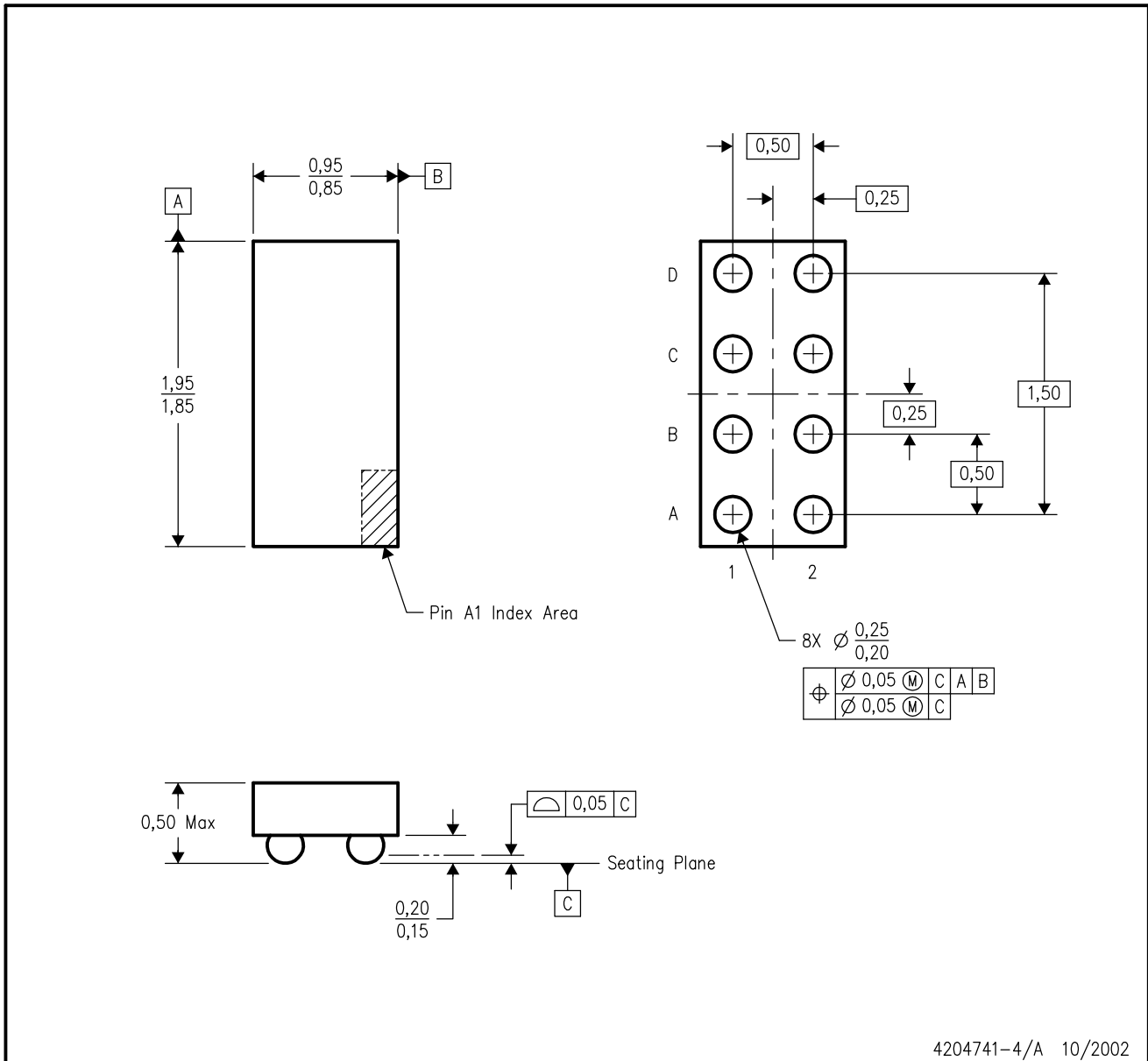

- NOTES:
- A. All linear dimensions are in millimeters.
 - B. This drawing is subject to change without notice.
 - C. NanoFree™ package configuration.
 - D. This package is lead-free. Refer to the 8 YEP package (drawing 4204725) for tin-lead (SnPb).

NanoFree is a trademark of Texas Instruments.

YEP (R-XBGA-N8)

DIE-SIZE BALL GRID ARRAY

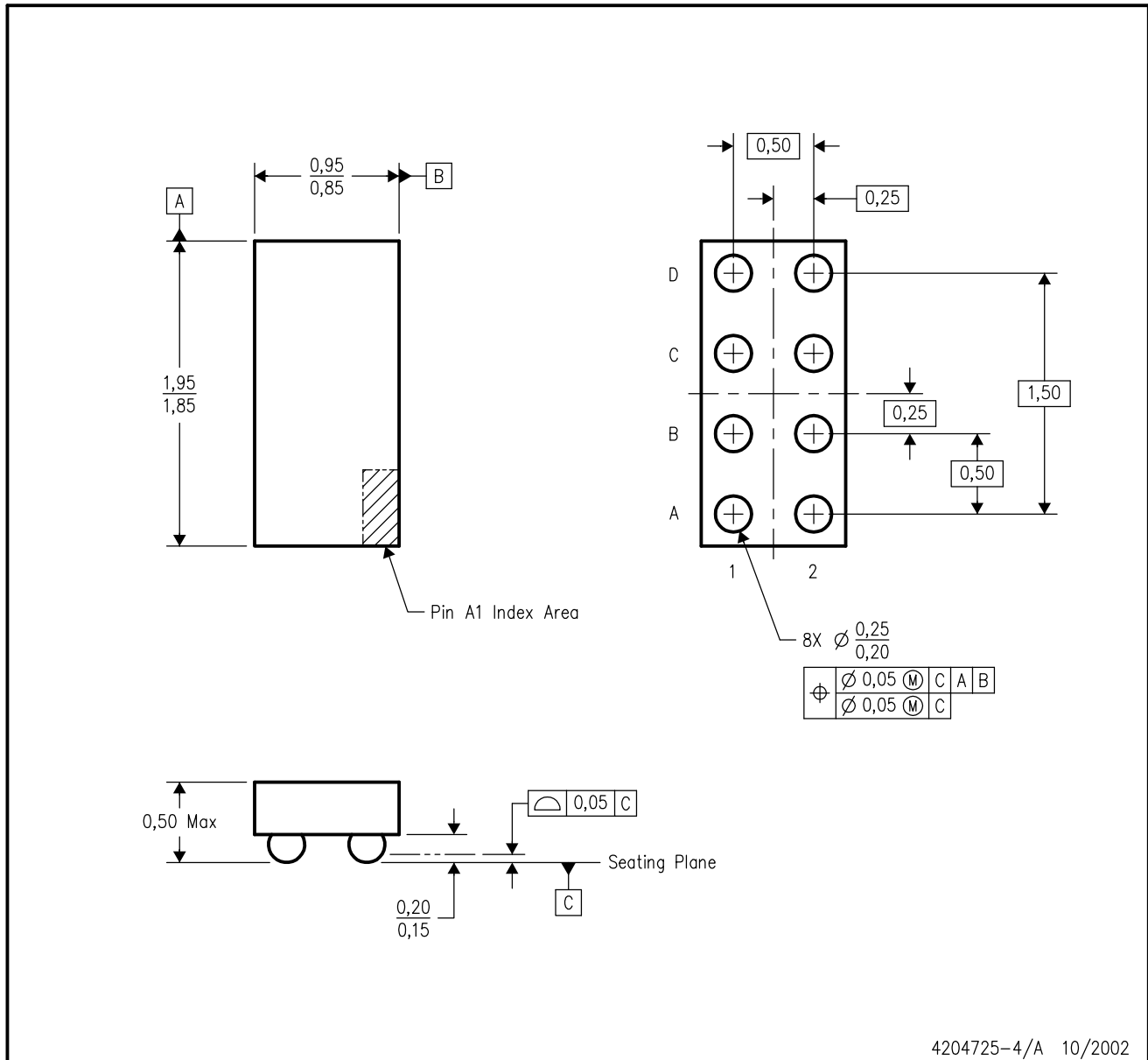

4204725-4/A 10/2002

- NOTES:
- A. All linear dimensions are in millimeters.
 - B. This drawing is subject to change without notice.
 - C. NanoStar™ package configuration.
 - D. This package is tin-lead (SnPb). Refer to the 8 YZP package (drawing 4204741) for lead-free.

NanoStar is a trademark of Texas Instruments.

IMPORTANT NOTICE

Texas Instruments Incorporated and its subsidiaries (TI) reserve the right to make corrections, modifications, enhancements, improvements, and other changes to its products and services at any time and to discontinue any product or service without notice. Customers should obtain the latest relevant information before placing orders and should verify that such information is current and complete. All products are sold subject to TI's terms and conditions of sale supplied at the time of order acknowledgment.

TI warrants performance of its hardware products to the specifications applicable at the time of sale in accordance with TI's standard warranty. Testing and other quality control techniques are used to the extent TI deems necessary to support this warranty. Except where mandated by government requirements, testing of all parameters of each product is not necessarily performed.

TI assumes no liability for applications assistance or customer product design. Customers are responsible for their products and applications using TI components. To minimize the risks associated with customer products and applications, customers should provide adequate design and operating safeguards.

TI does not warrant or represent that any license, either express or implied, is granted under any TI patent right, copyright, mask work right, or other TI intellectual property right relating to any combination, machine, or process in which TI products or services are used. Information published by TI regarding third-party products or services does not constitute a license from TI to use such products or services or a warranty or endorsement thereof. Use of such information may require a license from a third party under the patents or other intellectual property of the third party, or a license from TI under the patents or other intellectual property of TI.

Reproduction of information in TI data books or data sheets is permissible only if reproduction is without alteration and is accompanied by all associated warranties, conditions, limitations, and notices. Reproduction of this information with alteration is an unfair and deceptive business practice. TI is not responsible or liable for such altered documentation.

Resale of TI products or services with statements different from or beyond the parameters stated by TI for that product or service voids all express and any implied warranties for the associated TI product or service and is an unfair and deceptive business practice. TI is not responsible or liable for any such statements.

Following are URLs where you can obtain information on other Texas Instruments products and application solutions:

Products		Applications	
Amplifiers	amplifier.ti.com	Audio	www.ti.com/audio
Data Converters	dataconverter.ti.com	Automotive	www.ti.com/automotive
DSP	dsp.ti.com	Broadband	www.ti.com/broadband
Interface	interface.ti.com	Digital Control	www.ti.com/digitalcontrol
Logic	logic.ti.com	Military	www.ti.com/military
Power Mgmt	power.ti.com	Optical Networking	www.ti.com/opticalnetwork
Microcontrollers	microcontroller.ti.com	Security	www.ti.com/security
		Telephony	www.ti.com/telephony
		Video & Imaging	www.ti.com/video
		Wireless	www.ti.com/wireless

Mailing Address: Texas Instruments
Post Office Box 655303 Dallas, Texas 75265

Copyright © 2003, Texas Instruments Incorporated