

- **Single-Chip Parallel Multiple Instruction/Multiple Data (MIMD) Digital Signal Processor (DSP)**
- **More Than Two Billion RISC-Equivalent Operations per Second**
- **Master Processor (MP)**
 - 32-Bit Reduced Instruction Set Computing (RISC) Processor
 - IEEE-754 Floating-Point Capability
 - 4K-Byte Instruction Cache
 - 4K-Byte Data Cache
- **Four Parallel Processors (PP)**
 - 32-Bit Advanced DSPs
 - 64-Bit Opcode Provides Many Parallel Operations per Cycle
 - 2K-Byte Instruction Cache and 8K-Byte Data RAM per PP
- **Transfer Controller (TC)**
 - 64-Bit Data Transfers
 - Up to 400 Megabytes per Second (MBps) Transfer Rate
 - 32-Bit Addressing
 - Direct DRAM/VRAM Interface With Dynamic Bus Sizing
 - Intelligent Queuing and Cycle Prioritization
- **Video Controller (VC)**
 - Provides Video Timing and Video Random-Access Memory (VRAM) Control
 - Dual-Frame Timers for Two Simultaneous Image-Capture and/or Display Systems
- **Big- or Little-Endian Operation**
- **50K-Byte On-Chip RAM**
- **4G-Byte Address Space**
- **20-ns Cycle Time**
- **3.3-V Operation**
- **IEEE Standard 1149.1[†] Test Access Port (JTAG)**
- **Operating Temperature Range**
 - 55°C to 125°C - M-Temperature
 - 40°C to 85°C - A-Temperature

**GF PACKAGE
(BOTTOM VIEW)**

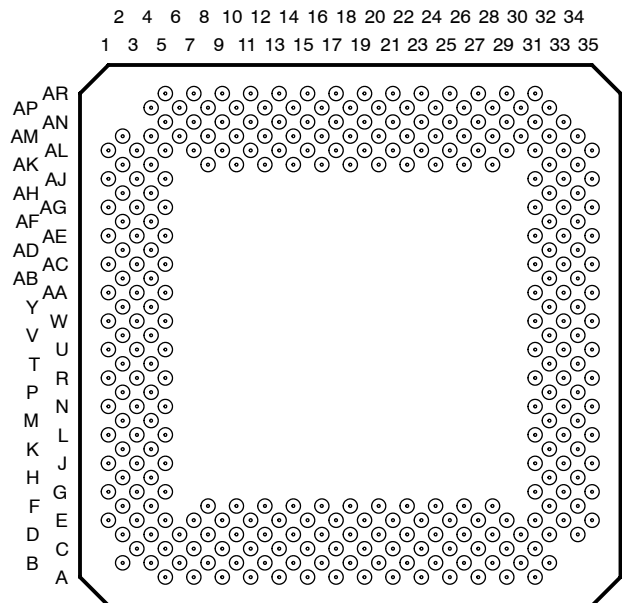

**HFH PACKAGE
(TOP VIEW)**

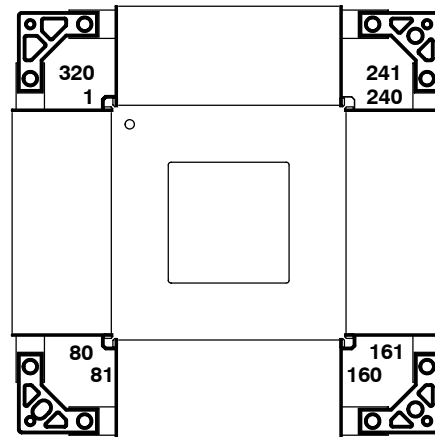

Please be aware that an important notice concerning availability, standard warranty, and use in critical applications of Texas Instruments semiconductor products and disclaimers thereto appears at the end of this data sheet.

[†] IEEE Standard 1149.1-1990, IEEE Standard Test Access Port and Boundary-Scan Architecture

PRODUCTION DATA information is current as of publication date. Products conform to specifications per the terms of Texas Instruments standard warranty. Production processing does not necessarily include testing of all parameters.



Copyright © 2002, Texas Instruments Incorporated
On products compliant to MIL-PRF-38535, all parameters are tested unless otherwise noted. On all other products, production processing does not necessarily include testing of all parameters.

SMJ320C80 DIGITAL SIGNAL PROCESSOR

SGUS025B - AUGUST 1998 - REVISED JUNE 2002

Table of Contents

description	2	host interface	128
GF Pin Assignments - Numerical Listing	3	device reset	128
GF Pin Assignments - Alphabetical Listing	5	absolute maximum ratings over specified temperature ranges	129
HFH Pin Assignments - Numerical Listing	7	recommended operating conditions	129
HFH Pin Assignments - Alphabetical Listing	9	electrical characteristics over recommended range of supply voltage and specified temperature	129
Terminal Functions	11	signal transition levels	130
architecture	14	timing parameter symbology	131
master processor (MP) architecture	17	general notes on timing parameters	132
MP control registers	21	CLKIN timing requirements	132
MP parameter RAM	28	local-bus switching characteristics over full operating range: CLKOUT	132
MP interrupt vectors	29	device reset timing requirements	133
PP architecture	35	local bus timing requirements: cycle configuration inputs	134
PP registers	38	local bus timing: cycle completion inputs	135
PP data-unit registers	39	general output signal characteristics over operating conditions	138
PP address-unit registers	39	data input timing	140
PP program flow control (PFC) unit registers	40	local bus timing: 2-cycle/column $\overline{\text{CAS}}$ timing	141
PP cache architecture	42	external interrupt timing	142
PP parameter RAM	43	XPT input timing	143
PP-interrupt vectors	43	host-interface timing	144
PP data-unit architecture	44	video interface timing: SCLK timing	145
PP multiplier	45	video interface timing: FCLK input and video outputs ..	146
PP program-flow-control unit architecture	46	video interface timing: external sync inputs	147
PP address-unit architecture	48	emulator interface connection	148
PP instruction set	49	MECHANICAL DATA	151
PP opcode formats	52	MECHANICAL DATA	152
EALU operations	61		
TC architecture	63		
local memory interface	67		
external memory timing examples	73		

description

The SMJ320C80 is a single-chip, MIMD parallel processor capable of performing over two billion operations per second. It consists of a 32-bit RISC master processor with a 100-MFLOPS (million floating-point operations per second) IEEE floating-point unit, four 32-bit parallel processing digital signal processors (DSPs), a transfer controller with up to 400-Mbps off-chip transfer rate, and a video controller. All the processors are coupled tightly through an on-chip crossbar that provides shared access to on-chip RAM. This performance and programmability make the 'C80 ideally suited for video, imaging, and high-speed telecommunications applications.



GF Pin Assignments - Numerical Listing

NUMBER	PIN NAME	NUMBER	PIN NAME	NUMBER	PIN NAME	NUMBER	PIN NAME
A5	CT1	C21	V _{DD}	E33	HSYNC ₀	L5	V _{SS}
A7	V _{DD}	C23	W	E35	TCK	L31	V _{SS}
A9	HACK	C25	DBEN	F2	V _{DD}	L33	TRST
A11	V _{SS}	C27	V _{SS}	F4	V _{SS}	L35	XPT ₁
A13	CAS/DQM7	C29	CAREA0	F8	V _{DD}	M2	V _{DD}
A15	CAS/DQM5	C31	CBLNK ₀ /VBLNK ₀	F10	V _{SS}	M4	V _{SS}
A17	V _{DD}	D2	RETRY	F12	V _{DD}	M32	V _{SS}
A19	V _{SS}	D4	V _{DD}	F14	PS0	M34	V _{DD}
A21	RAS	D6	V _{SS}	F16	V _{SS}	N1	V _{DD}
A23	DSF	D8	AS0	F18	CT2	N3	A8
A25	V _{SS}	D10	UTIME	F20	V _{DD}	N5	V _{SS}
A27	SCLK1	D12	V _{SS}	F22	V _{SS}	N31	V _{SS}
A29	V _{DD}	D14	RESET	F24	V _{DD}	N33	TMS
A31	EINT ₁	D16	REQ0	F26	V _{SS}	N35	V _{DD}
B2	NC	D18	V _{SS}	F28	V _{DD}	P2	A4
B4	BS1	D20	CAS/DQM0	F32	V _{SS}	P4	A9
B6	V _{DD}	D22	FCLK1	F34	V _{DD}	P32	TDO
B8	PS1	D24	V _{SS}	G1	V _{DD}	P34	XPT ₀
B10	REQ1	D26	CAREA1	G3	A2	R1	V _{SS}
B12	V _{DD}	D28	SCLK0	G5	A1	R3	V _{DD}
B14	CAS/DQM6	D30	V _{SS}	G31	EINT ₂	R5	V _{DD}
B16	CAS/DQM3	D32	V _{DD}	G33	CBLNK ₁ /VBLNK ₁	R31	V _{DD}
B18	V _{DD}	D34	VSYNC ₀	G35	V _{DD}	R33	V _{DD}
B20	CAS/DQM1	E1	AS1	H2	STATUS0	R35	V _{SS}
B22	TRG/CAS	E3	FAULT	H4	A3	T2	A5
B24	V _{DD}	E5	V _{SS}	H32	CSYNC ₁ /HBLNK ₁	T4	A13
B26	DDIN	E7	STATUS2	H34	TDI	T32	D62
B28	FCLK0	E9	READY	J1	STATUS1	T34	EMU0
B30	V _{DD}	E11	BS0	J3	V _{SS}	U1	V _{DD}
B32	CSYNC ₀ /HBLNK ₀	E13	V _{SS}	J5	V _{DD}	U3	A10
C3	V _{SS}	E15	HREQ	J31	V _{DD}	U5	PS3
C5	STATUS3	E17	CAS/DQM4	J33	V _{SS}	U31	NC
C7	AS2	E19	RL	J35	EMU1	U33	D61
C9	V _{SS}	E21	STATUS5	K2	STATUS4	U35	V _{DD}
C11	CT0	E23	V _{SS}	K4	A6	V2	V _{DD}
C13	PS2	E25	CLKOUT	K32	VSYNC ₁	V4	V _{SS}
C15	V _{DD}	E27	LINT ₄	K34	HSYNC ₁	V32	V _{SS}
C17	CLKIN	E29	EINT ₃	L1	A0	V34	V _{DD}
C19	CAS/DQM2	E31	V _{SS}	L3	A7	W1	A11

SMJ320C80 DIGITAL SIGNAL PROCESSOR

SGUS025B - AUGUST 1998 - REVISED JUNE 2002

GF Pin Assignments - Numerical Listing (Continued)

PIN		PIN		PIN		PIN	
NUMBER	NAME	NUMBER	NAME	NUMBER	NAME	NUMBER	NAME
W3	A18	AG1	A16	AL17	D20	AN29	D35
W5	V _{SS}	AG3	V _{SS}	AL19	D21	AN31	D45
W31	V _{SS}	AG5	V _{DD}	AL21	D24	AN33	V _{DD}
W33	D59	AG31	V _{DD}	AL23	V _{SS}	AP4	A27
W35	D63	AG33	V _{SS}	AL25	D29	AP6	V _{DD}
Y2	A12	AG35	D57	AL27	D32	AP8	D5
Y4	A19	AH2	A20	AL29	D38	AP10	D8
Y32	XPT ₂	AH4	A30	AL31	V _{SS}	AP12	V _{DD}
Y34	D56	AH32	D44	AL33	D48	AP14	D13
AA1	V _{SS}	AH34	D54	AL35	D53	AP16	D17
AA3	V _{DD}	AJ1	V _{DD}	AM2	A24	AP18	V _{DD}
AA5	V _{DD}	AJ3	A31	AM4	V _{DD}	AP20	D26
AA31	V _{DD}	AJ5	V _{SS}	AM6	V _{SS}	AP22	D34
AA33	V _{DD}	AJ31	V _{SS}	AM8	D2	AP24	V _{DD}
AA35	V _{SS}	AJ33	D42	AM10	D6	AP26	D39
AB2	A14	AJ35	V _{DD}	AM12	V _{SS}	AP28	D41
AB4	A21	AK2	V _{DD}	AM14	D14	AP30	V _{DD}
AB32	D55	AK4	V _{SS}	AM16	D19	AP32	D47
AB34	D60	AK8	V _{DD}	AM18	V _{SS}	AR5	D0
AC1	V _{DD}	AK10	V _{SS}	AM20	D23	AR7	V _{DD}
AC3	A22	AK12	V _{DD}	AM22	D25	AR9	D7
AC5	V _{SS}	AK14	V _{SS}	AM24	V _{SS}	AR11	V _{SS}
AC31	V _{SS}	AK16	V _{DD}	AM26	D31	AR13	D11
AC33	D52	AK18	NC	AM28	D33	AR15	D15
AC35	V _{DD}	AK20	V _{SS}	AM30	V _{SS}	AR17	V _{SS}
AD2	V _{DD}	AK22	D27	AM32	V _{DD}	AR19	V _{DD}
AD4	V _{SS}	AK24	V _{DD}	AM34	D50	AR21	D30
AD32	V _{SS}	AK26	V _{SS}	AN5	A29	AR23	D36
AD34	V _{DD}	AK28	V _{DD}	AN7	D1	AR25	V _{SS}
AE1	A15	AK32	V _{SS}	AN9	V _{SS}	AR27	D40
AE3	A26	AK34	V _{DD}	AN11	D9	AR29	V _{DD}
AE5	V _{SS}	AL1	A23	AN13	D12	AR31	D43
AE31	V _{SS}	AL3	A25	AN15	V _{DD}		
AE33	D51	AL5	V _{SS}	AN17	D18		
AE35	D58	AL7	D3	AN19	D22		
AF2	A17	AL9	D4	AN21	V _{DD}		
AF4	A28	AL11	D10	AN23	D28		
AF32	D46	AL13	V _{SS}	AN25	D37		
AF34	D49	AL15	D16	AN27	V _{SS}		



GF Pin Assignments - Alphabetical Listing

PIN		PIN		PIN		PIN	
NAME	NUMBER	NAME	NUMBER	NAME	NUMBER	NAME	NUMBER
A0	L1	$\overline{\text{CAS}}/\text{DQM1}$	B20	D24	AL21	$\overline{\text{DBEN}}$	C25
A1	G5	$\overline{\text{CAS}}/\text{DQM2}$	C19	D25	AM22	$\overline{\text{DDIN}}$	B26
A2	G3	$\overline{\text{CAS}}/\text{DQM3}$	B16	D26	AP20	DSF	A23
A3	H4	$\overline{\text{CAS}}/\text{DQM4}$	E17	D27	AK22	$\overline{\text{EINT1}}$	A31
A4	P2	$\overline{\text{CAS}}/\text{DQM5}$	A15	D28	AN23	$\overline{\text{EINT2}}$	G31
A5	T2	$\overline{\text{CAS}}/\text{DQM6}$	B14	D29	AL25	$\overline{\text{EINT3}}$	E29
A6	K4	$\overline{\text{CAS}}/\text{DQM7}$	A13	D30	AR21	EMU0	T34
A7	L3	$\overline{\text{CBLNK0}}/\overline{\text{VBLNK0}}$	C31	D31	AM26	EMU1	J35
A8	N3	$\overline{\text{CBLNK1}}/\overline{\text{VBLNK1}}$	G33	D32	AL27	FAULT	E3
A9	P4	CLKIN	C17	D33	AM28	FCLK0	B28
A10	U3	CLKOUT	E25	D34	AP22	FCLK1	D22
A11	W1	$\overline{\text{CSYNC0}}/\overline{\text{HBLNK0}}$	B32	D35	AN29	HACK	A9
A12	Y2	$\overline{\text{CSYNC1}}/\overline{\text{HBLNK1}}$	H32	D36	AR23	$\overline{\text{HREQ}}$	E15
A13	T4	CT0	C11	D37	AN25	$\overline{\text{HSYNC0}}$	E33
A14	AB2	CT1	A5	D38	AL29	$\overline{\text{HSYNC1}}$	K34
A15	AE1	CT2	F18	D39	AP26	$\overline{\text{LINT4}}$	E27
A16	AG1	D0	AR5	D40	AR27	NC	B2
A17	AF2	D1	AN7	D41	AP28	NC	U31
A18	W3	D2	AM8	D42	AJ33	NC	AK18
A19	Y4	D3	AL7	D43	AR31	PS0	F14
A20	AH2	D4	AL9	D44	AH32	PS1	B8
A21	AB4	D5	AP8	D45	AN31	PS2	C13
A22	AC3	D6	AM10	D46	AF32	PS3	U5
A23	AL1	D7	AR9	D47	AP32	$\overline{\text{RAS}}$	A21
A24	AM2	D8	AP10	D48	AL33	READY	E9
A25	AL3	D9	AN11	D49	AF34	REQ0	D16
A26	AE3	D10	AL11	D50	AM34	REQ1	B10
A27	AP4	D11	AR13	D51	AE33	$\overline{\text{RESET}}$	D14
A28	AF4	D12	AN13	D52	AC33	$\overline{\text{RETRY}}$	D2
A29	AN5	D13	AP14	D53	AL35	$\overline{\text{RL}}$	E19
A30	AH4	D14	AM14	D54	AH34	SCLK0	D28
A31	AJ3	D15	AR15	D55	AB32	SCLK1	A27
AS0	D8	D16	AL15	D56	Y34	STATUS0	H2
AS1	E1	D17	AP16	D57	AG35	STATUS1	J1
AS2	C7	D18	AN17	D58	AE35	STATUS2	E7
BS0	E11	D19	AM16	D59	W33	STATUS3	C5
BS1	B4	D20	AL17	D60	AB34	STATUS4	K2
CAREA0	C29	D21	AL19	D61	U33		
CAREA1	D26	D22	AN19	D62	T32		
$\overline{\text{CAS}}/\text{DQM0}$	D20	D23	AM20	D63	W35		

SMJ320C80 DIGITAL SIGNAL PROCESSOR

SGUS025B - AUGUST 1998 - REVISED JUNE 2002

GF Pin Assignments - Alphabetical Listing (Continued)

PIN		PIN		PIN		PIN	
NAME	NUMBER	NAME	NUMBER	NAME	NUMBER	NAME	NUMBER
STATUS5	E21	V _{DD}	R31	V _{DD}	AR29	V _{SS}	AA35
TCK	E35	V _{DD}	R33	V _{SS}	A11	V _{SS}	AC5
TDI	H34	V _{DD}	U1	V _{SS}	A19	V _{SS}	AC31
TDO	P32	V _{DD}	U35	V _{SS}	A25	V _{SS}	AD4
TMS	N33	V _{DD}	V2	V _{SS}	C3	V _{SS}	AD32
TRG/CAS	B22	V _{DD}	V34	V _{SS}	C9	V _{SS}	AE5
TRST	L33	V _{DD}	AA3	V _{SS}	C27	V _{SS}	AE31
UTIME	D10	V _{DD}	AA5	V _{SS}	D6	V _{SS}	AG3
V _{DD}	A7	V _{DD}	AA31	V _{SS}	D12	V _{SS}	AG33
V _{DD}	A17	V _{DD}	AA33	V _{SS}	D18	V _{SS}	AJ5
V _{DD}	A29	V _{DD}	AC1	V _{SS}	D24	V _{SS}	AJ31
V _{DD}	B6	V _{DD}	AC35	V _{SS}	D30	V _{SS}	AK4
V _{DD}	B12	V _{DD}	AD2	V _{SS}	E5	V _{SS}	AK10
V _{DD}	B18	V _{DD}	AD34	V _{SS}	E13	V _{SS}	AK14
V _{DD}	B24	V _{DD}	AG5	V _{SS}	E23	V _{SS}	AK20
V _{DD}	B30	V _{DD}	AG31	V _{SS}	E31	V _{SS}	AK26
V _{DD}	C15	V _{DD}	AJ1	V _{SS}	F4	V _{SS}	AK32
V _{DD}	C21	V _{DD}	AJ35	V _{SS}	F10	V _{SS}	AL5
V _{DD}	D4	V _{DD}	AK2	V _{SS}	F16	V _{SS}	AL13
V _{DD}	D32	V _{DD}	AK8	V _{SS}	F22	V _{SS}	AL23
V _{DD}	F2	V _{DD}	AK12	V _{SS}	F26	V _{SS}	AL31
V _{DD}	F8	V _{DD}	AK16	V _{SS}	F32	V _{SS}	AM6
V _{DD}	F12	V _{DD}	AK24	V _{SS}	J3	V _{SS}	AM12
V _{DD}	F20	V _{DD}	AK28	V _{SS}	J33	V _{SS}	AM18
V _{DD}	F24	V _{DD}	AK34	V _{SS}	L5	V _{SS}	AM24
V _{DD}	F28	V _{DD}	AM4	V _{SS}	L31	V _{SS}	AM30
V _{DD}	F34	V _{DD}	AM32	V _{SS}	M4	V _{SS}	AN9
V _{DD}	G1	V _{DD}	AN15	V _{SS}	M32	V _{SS}	AN27
V _{DD}	G35	V _{DD}	AN21	V _{SS}	N5	V _{SS}	AR11
V _{DD}	J5	V _{DD}	AN33	V _{SS}	N31	V _{SS}	AR17
V _{DD}	J31	V _{DD}	AP6	V _{SS}	R1	V _{SS}	AR25
V _{DD}	M2	V _{DD}	AP12	V _{SS}	R35	$\overline{VSYNC0}$	D34
V _{DD}	M34	V _{DD}	AP18	V _{SS}	V4	$\overline{VSYNC1}$	K32
V _{DD}	N1	V _{DD}	AP24	V _{SS}	V32	\overline{W}	C23
V _{DD}	N35	V _{DD}	AP30	V _{SS}	W5	$\overline{XPT0}$	P34
V _{DD}	R3	V _{DD}	AR7	V _{SS}	W31	$\overline{XPT1}$	L35
V _{DD}	R5	V _{DD}	AR19	V _{SS}	AA1	$\overline{XPT2}$	Y32



HFH Pin Assignments - Numerical Listing

NUMBER	PIN NAME	NUMBER	PIN NAME	NUMBER	PIN NAME	NUMBER	PIN NAME
1	STATUS3	41	$\overline{\text{CAS/DQM6}}$	81	$\overline{\text{LINT4}}$	121	V _{DD}
2	V _{SS}	42	V _{SS}	82	$\overline{\text{EINT3}}$	122	D59
3	STATUS2	43	$\overline{\text{CAS/DQM5}}$	83	$\overline{\text{EINT2}}$	123	V _{SS}
4	STATUS1	44	V _{DD}	84	$\overline{\text{EINT1}}$	124	D58
5	V _{DD}	45	$\overline{\text{CAS/DQM4}}$	85	$\overline{\text{CBLNK1/VBLNK1}}$	125	V _{DD}
6	STATUS0	46	$\overline{\text{CAS/DQM3}}$	86	$\overline{\text{CBLNK0/VBLNK0}}$	126	D57
7	AS2	47	CT2	87	V _{SS}	127	$\overline{\text{XPT2}}$
8	AS1	48	$\overline{\text{CAS/DQM2}}$	88	V _{SS}	128	V _{SS}
9	AS0	49	V _{SS}	89	$\overline{\text{CSYNC1/HBLNK1}}$	129	D56
10	$\overline{\text{FAULT}}$	50	$\overline{\text{CAS/DQM1}}$	90	V _{DD}	130	V _{DD}
11	READY	51	V _{DD}	91	V _{DD}	131	V _{DD}
12	RETRY	52	$\overline{\text{CAS/DQM0}}$	92	$\overline{\text{CSYNC0/HBLNK0}}$	132	D55
13	UTIME	53	$\overline{\text{RL}}$	93	V _{SS}	133	V _{SS}
14	BS1	54	$\overline{\text{RAS}}$	94	V _{SS}	134	D54
15	BS0	55	V _{SS}	95	V _{SS}	135	V _{DD}
16	CT1	56	V _{SS}	96	V _{SS}	136	D53
17	CT0	57	V _{SS}	97	$\overline{\text{HSYNC1}}$	137	V _{SS}
18	PS2	58	$\overline{\text{TRG/CAS}}$	98	V _{DD}	138	V _{SS}
19	PS1	59	V _{DD}	99	V _{DD}	139	D52
20	PS0	60	FCLK1	100	V _{DD}	140	V _{DD}
21	V _{DD}	61	V _{DD}	101	$\overline{\text{HSYNC0}}$	141	D51
22	$\overline{\text{RESET}}$	62	V _{DD}	102	$\overline{\text{TRST}}$	142	D50
23	V _{SS}	63	$\overline{\text{W}}$	103	TCK	143	D49
24	$\overline{\text{HREQ}}$	64	STATUS5	104	TMS	144	V _{SS}
25	$\overline{\text{HACK}}$	65	V _{DD}	105	TDI	145	V _{SS}
26	V _{SS}	66	DSF	106	TDO	146	D48
27	V _{SS}	67	V _{SS}	107	EMU1	147	V _{DD}
28	REQ1	68	$\overline{\text{DBEN}}$	108	$\overline{\text{XPT0}}$	148	V _{DD}
29	REQ0	69	V _{DD}	109	$\overline{\text{XPT1}}$	149	V _{DD}
30	V _{DD}	70	$\overline{\text{DDIN}}$	110	V _{SS}	150	D47
31	V _{DD}	71	CLKOUT	111	V _{SS}	151	D46
32	V _{SS}	72	CAREA1	112	EMU0	152	D45
33	V _{DD}	73	V _{SS}	113	V _{DD}	153	V _{SS}
34	V _{SS}	74	SCLK1	114	D63	154	V _{SS}
35	V _{SS}	75	V _{DD}	115	D62	155	D44
36	CLKIN	76	FCLK0	116	V _{SS}	156	V _{DD}
37	V _{SS}	77	V _{SS}	117	D61	157	V _{DD}
38	$\overline{\text{CAS/DQM7}}$	78	SCLK0	118	V _{SS}	158	V _{DD}
39	V _{DD}	79	V _{DD}	119	D60	159	D43
40	V _{DD}	80	CAREA0	120	V _{DD}	160	D42

SMJ320C80 DIGITAL SIGNAL PROCESSOR

SGUS025B - AUGUST 1998 - REVISED JUNE 2002

HFH Pin Assignments - Numerical Listing (Continued)

NUMBER	PIN NAME	NUMBER	NAME	NUMBER	PIN NAME	NUMBER	PIN NAME
161	D41	201	D20	241	D0	281	V _{DD}
162	V _{SS}	202	V _{DD}	242	V _{DD}	282	V _{DD}
163	V _{SS}	203	V _{DD}	243	V _{DD}	283	V _{DD}
164	D40	204	D19	244	A31	284	A15
165	V _{DD}	205	V _{DD}	245	V _{SS}	285	PS3
166	D39	206	D18	246	A30	286	A14
167	D38	207	V _{SS}	247	A29	287	V _{SS}
168	D37	208	D17	248	V _{SS}	288	V _{DD}
169	V _{SS}	209	V _{SS}	249	V _{SS}	289	A13
170	D36	210	V _{SS}	250	A28	290	V _{SS}
171	V _{SS}	211	D16	251	V _{DD}	291	V _{SS}
172	V _{DD}	212	V _{DD}	252	V _{DD}	292	A12
173	D35	213	D15	253	V _{DD}	293	V _{DD}
174	D34	214	D14	254	A27	294	A11
175	D33	215	D13	255	A26	295	V _{SS}
176	V _{SS}	216	V _{SS}	256	A25	296	A10
177	D32	217	V _{SS}	257	V _{SS}	297	V _{DD}
178	V _{DD}	218	D12	258	V _{SS}	298	A9
179	V _{DD}	219	V _{DD}	259	V _{SS}	299	V _{SS}
180	D31	220	V _{DD}	260	A24	300	A8
181	D30	221	V _{DD}	261	V _{DD}	301	V _{DD}
182	D29	222	D11	262	V _{DD}	302	A7
183	V _{SS}	223	D10	263	V _{DD}	303	A6
184	V _{SS}	224	D9	264	A23	304	V _{SS}
185	V _{SS}	225	V _{SS}	265	A22	305	V _{SS}
186	D28	226	D8	266	V _{DD}	306	A5
187	V _{DD}	227	V _{DD}	267	A21	307	V _{SS}
188	V _{DD}	228	V _{DD}	268	V _{SS}	308	A4
189	D27	229	D7	269	V _{SS}	309	V _{DD}
190	D26	230	D6	270	A20	310	V _{DD}
191	D25	231	D5	271	V _{DD}	311	V _{DD}
192	V _{SS}	232	V _{SS}	272	V _{DD}	312	A3
193	D24	233	V _{SS}	273	A19	313	V _{DD}
194	V _{DD}	234	D4	274	V _{SS}	314	A2
195	V _{DD}	235	V _{DD}	275	A18	315	V _{SS}
196	D23	236	D3	276	A17	316	A1
197	D22	237	D2	277	V _{SS}	317	A0
198	V _{SS}	238	V _{SS}	278	V _{SS}	318	V _{DD}
199	D21	239	D1	279	V _{SS}	319	STATUS4
200	V _{SS}	240	V _{SS}	280	A16	320	V _{SS}



HFH Pin Assignments - Alphabetical Listing

PIN		PIN		PIN		PIN	
NAME	NUMBER	NAME	NUMBER	NAME	NUMBER	NAME	NUMBER
A0	317	$\overline{\text{CAS}}/\text{DQM1}$	50	D30	181	$\overline{\text{DBEN}}$	68
A1	316	$\overline{\text{CAS}}/\text{DQM2}$	48	D31	180	$\overline{\text{DDIN}}$	70
A10	296	$\overline{\text{CAS}}/\text{DQM3}$	46	D32	177	DSF	66
A11	294	$\overline{\text{CAS}}/\text{DQM4}$	45	D33	175	EINT1	84
A12	292	$\overline{\text{CAS}}/\text{DQM5}$	43	D34	174	EINT2	83
A13	289	$\overline{\text{CAS}}/\text{DQM6}$	41	D35	173	EINT3	82
A14	286	$\overline{\text{CAS}}/\text{DQM7}$	38	D36	170	EMU0	112
A15	284	$\overline{\text{CBLNK0}}/\overline{\text{VBLNK0}}$	86	D37	168	EMU1	107
A16	280	$\overline{\text{CBLNK1}}/\overline{\text{VBLNK1}}$	85	D38	167	FAULT	10
A17	276	CLKIN	36	D39	166	FCLK0	76
A18	275	CLKOUT	71	D4	234	FCLK1	60
A19	273	$\overline{\text{CSYNC0}}/\overline{\text{HBLNK0}}$	92	D40	164	HACK	25
A2	314	$\overline{\text{CSYNC1}}/\overline{\text{HBLNK1}}$	89	D41	161	HREQ	24
A20	270	CT0	17	D42	160	$\overline{\text{HSYNC0}}$	101
A21	267	CT1	16	D43	159	$\overline{\text{HSYNC1}}$	97
A22	265	CT2	47	D44	155	$\overline{\text{LINT4}}$	81
A23	264	D0	241	D45	152	PS0	20
A24	260	D1	239	D46	151	PS1	19
A25	256	D10	223	D47	150	PS2	18
A26	255	D11	222	D48	146	PS3	285
A27	254	D12	218	D49	143	$\overline{\text{RAS}}$	54
A28	250	D13	215	D5	231	READY	11
A29	247	D14	214	D50	142	REQ0	29
A3	312	D15	213	D51	141	REQ1	28
A30	246	D16	211	D52	139	RESET	22
A31	244	D17	208	D53	136	RETRY	12
A4	308	D18	206	D54	134	$\overline{\text{RL}}$	53
A5	306	D19	204	D55	132	SCLK0	78
A6	303	D2	237	D56	129	SCLK1	74
A7	302	D20	201	D57	126	STATUS0	6
A8	300	D21	199	D58	124	STATUS1	4
A9	298	D22	197	D59	122	STATUS2	3
AS0	9	D23	196	D6	230	STATUS3	1
AS1	8	D24	193	D60	119	STATUS4	319
AS2	7	D25	191	D61	117	STATUS5	64
BS0	15	D26	190	D62	115	TCK	103
BS1	14	D27	189	D63	114	TDI	105
CAREA0	80	D28	186	D7	229		
CAREA1	72	D29	182	D8	226		
$\overline{\text{CAS}}/\text{DQM0}$	52	D3	236	D9	224		

SMJ320C80 DIGITAL SIGNAL PROCESSOR

SGUS025B - AUGUST 1998 - REVISED JUNE 2002

HFH Pin Assignments - Alphabetical Listing (Continued)

PIN		PIN		PIN		PIN	
NAME	NUMBER	NAME	NUMBER	NAME	NUMBER	NAME	NUMBER
TDO	106	V _{DD}	243	V _{SS}	110	V _{SS}	259
TMS	104	V _{DD}	251	V _{SS}	111	V _{SS}	26
TRG/CAS	58	V _{DD}	252	V _{SS}	116	V _{SS}	268
TRST	102	V _{DD}	253	V _{SS}	118	V _{SS}	269
UTIME	13	V _{DD}	261	V _{SS}	123	V _{SS}	27
V _{DD}	100	V _{DD}	262	V _{SS}	128	V _{SS}	274
V _{DD}	113	V _{DD}	263	V _{SS}	133	V _{SS}	277
V _{DD}	120	V _{DD}	266	V _{SS}	137	V _{SS}	278
V _{DD}	121	V _{DD}	271	V _{SS}	138	V _{SS}	279
V _{DD}	125	V _{DD}	272	V _{SS}	144	V _{SS}	287
V _{DD}	130	V _{DD}	281	V _{SS}	145	V _{SS}	290
V _{DD}	131	V _{DD}	282	V _{SS}	153	V _{SS}	291
V _{DD}	135	V _{DD}	283	V _{SS}	154	V _{SS}	295
V _{DD}	140	V _{DD}	288	V _{SS}	162	V _{SS}	299
V _{DD}	147	V _{DD}	293	V _{SS}	163	V _{SS}	304
V _{DD}	148	V _{DD}	297	V _{SS}	169	V _{SS}	305
V _{DD}	149	V _{DD}	30	V _{SS}	171	V _{SS}	307
V _{DD}	156	V _{DD}	301	V _{SS}	176	V _{SS}	315
V _{DD}	157	V _{DD}	309	V _{SS}	183	V _{SS}	320
V _{DD}	158	V _{DD}	310	V _{SS}	184	V _{SS}	34
V _{DD}	165	V _{DD}	311	V _{SS}	185	V _{SS}	35
V _{DD}	172	V _{DD}	313	V _{SS}	192	V _{SS}	37
V _{DD}	178	V _{DD}	318	V _{SS}	198	V _{SS}	42
V _{DD}	179	V _{DD}	39	V _{SS}	2	V _{SS}	49
V _{DD}	187	V _{DD}	40	V _{SS}	200	V _{SS}	55
V _{DD}	188	V _{DD}	33	V _{SS}	207	V _{SS}	56
V _{DD}	194	V _{DD}	44	V _{SS}	209	V _{SS}	57
V _{DD}	195	V _{DD}	5	V _{SS}	216	V _{SS}	67
V _{DD}	202	V _{DD}	51	V _{SS}	217	V _{SS}	73
V _{DD}	203	V _{DD}	59	V _{SS}	225	V _{SS}	77
V _{DD}	205	V _{DD}	61	V _{SS}	23	V _{SS}	87
V _{DD}	21	V _{DD}	62	V _{SS}	232	V _{SS}	88
V _{DD}	212	V _{DD}	65	V _{SS}	233	V _{SS}	95
V _{DD}	219	V _{DD}	69	V _{SS}	238	V _{SS}	96
V _{DD}	220	V _{DD}	75	V _{SS}	240	V _{SS}	94
V _{DD}	221	V _{DD}	79	V _{SS}	245	V _{SS}	93
V _{DD}	227	V _{DD}	90	V _{SS}	248	V _{SS}	63
V _{DD}	228	V _{DD}	91	V _{SS}	249	V _{SS}	108
V _{DD}	235	V _{DD}	98	V _{SS}	257	V _{SS}	109
V _{DD}	31	V _{DD}	99	V _{SS}	210	V _{SS}	127
V _{DD}	242	V _{SS}	32	V _{SS}	258		



Terminal Functions

TERMINAL NAME	TYPE†	DESCRIPTION
LOCAL MEMORY INTERFACE		
A31-A0	O	Address bus. A31-A0 output the 32-bit byte address of the external memory cycle. The address can be multiplexed for DRAM accesses.
AS2-AS0	I	Address-shift selection. AS2-AS0 determine how the column address appears on the address bus. Eight shift values are supported, including zero.
BS1-BS0	I	Bus size selection. BS1-BS0 indicate the bus size of the memory or other devices being accessed, allowing dynamic bus sizing for data buses less than 64 bits wide.
CT2-CT0	I	Cycle timing selection. CT2-CT0 signals determine the timing of the current memory access.
D63-D0	I/O	Data bus. D63-D0 transfer up to 64 bits of data per memory cycle into or out of the 'C80.
$\overline{\text{DBEN}}$	O	Data-buffer enable. $\overline{\text{DBEN}}$ drives the active-low output enables of bidirectional transceivers that can be used to buffer input and output data on D63-D0.
$\overline{\text{DDIN}}$	O	Data direction indicator. $\overline{\text{DDIN}}$ indicates the direction of the data that passes through the transceivers. When $\overline{\text{DDIN}}$ is low, the transfer is from external memory into the 'C80.
FAULT	I	Fault. FAULT is driven low by external circuitry to inform the 'C80 that a fault has occurred on the current memory row access.
PS3-PS0	I	Page size indication. PS3-PS0 indicate the page size of the memory device(s) being accessed by the current cycle. The 'C80 uses this information to determine when to begin a new row access.
READY	I	Ready. READY indicates that the external device is ready to complete the memory cycle. READY is driven low by external circuitry to insert wait states into a memory cycle.
RL	O	Row latch. The high-to-low transition of RL can be used to latch the valid 32-bit byte address that is present on A31-A0.
$\overline{\text{RETRY}}$	I	Retry. $\overline{\text{RETRY}}$ is driven low by external circuitry to indicate that the addressed memory is busy. The 'C80 memory cycle is rescheduled.
STATUS5-STATUS0	O	Status code. At row time, STATUS5-STATUS0 indicate the type of cycle being performed. At column time, they identify the processor and type of request that initiated the cycle.
UTIME	I	User-timing selection. UTIME causes the timing of $\overline{\text{RAS}}$ and $\overline{\text{CAS/DQM7-CAS/DQM0}}$ to be modified so that custom memory timings can be generated. During reset, UTIME selects the endian mode in which the 'C80 operates.
DRAM, VRAM, AND SDRAM CONTROL		
$\overline{\text{CAS/DQM7-CAS/DQM0}}$	O	Column-address strobes. $\overline{\text{CAS/DQM7-CAS/DQM0}}$ drive the $\overline{\text{CAS}}$ inputs of DRAMs and VRAMs, or the DQM input of synchronous dynamic random-access memories (SDRAMs). The eight strobes provide byte-write access to memory.
DSF	O	Special function. DSF selects special VRAM functions such as block-write, load color register, split-register transfer, and synchronous graphics random-access memory (SGRAM) block write.
$\overline{\text{RAS}}$	O	Row-address strobe. $\overline{\text{RAS}}$ drives the $\overline{\text{RAS}}$ inputs of DRAMs, VRAMs, and SDRAMs.
TRG/ $\overline{\text{CAS}}$	O	Transfer/output enable or column-address strobe. TRG/ $\overline{\text{CAS}}$ is used as an output enable for DRAMs and VRAMs, and also as a transfer enable for VRAMs. TRG/ $\overline{\text{CAS}}$ also drives the $\overline{\text{CAS}}$ inputs of SDRAMs.
$\overline{\text{W}}$	O	Write enable. $\overline{\text{W}}$ is driven low before $\overline{\text{CAS}}$ during write cycles. $\overline{\text{W}}$ controls the direction of the transfer during VRAM transfer cycles.

† I = input, O = output, Z = high-impedance

‡ This pin has an internal pullup and can be left unconnected during normal operation.

§ This pin has an internal pulldown and can be left unconnected during normal operation.

¶ For proper operation, all V_{DD} and V_{SS} pins must be connected externally.

SMJ320C80 DIGITAL SIGNAL PROCESSOR

SGUS025B - AUGUST 1998 - REVISED JUNE 2002

Terminal Functions (Continued)

TERMINAL NAME	TYPE†	DESCRIPTION
HOST INTERFACE		
HACK	O	Host acknowledge. The 'C80 drives $\overline{\text{HACK}}$ output low following an active HREQ to indicate that it has driven the local memory bus signals to the high-impedance state and is relinquishing the bus. $\overline{\text{HACK}}$ is driven high asynchronously following $\overline{\text{HREQ}}$ being detected inactive, and then the 'C80 resumes driving the bus.
HREQ	I	Host request. An external device drives $\overline{\text{HREQ}}$ low to request ownership of the local memory bus. When $\overline{\text{HREQ}}$ is high, the 'C80 owns and drives the bus. $\overline{\text{HREQ}}$ is synchronized internally to the 'C80's internal clock. Also, HREQ is used at reset to determine the power-up state of the MP. If HREQ is low at the rising edge of RESET, the MP comes up running. If HREQ is high, the MP remains halted until the first interrupt occurrence on EINT3.
REQ1, REQ0	O	Internal cycle request. REQ1 and REQ0 provide a two-bit code indicating the highest-priority memory cycle request that is being received by the TC. External logic can monitor REQ1 and REQ0 to determine if it is necessary to relinquish the local memory bus to the 'C80.
SYSTEM CONTROL		
CLKIN	I	Input clock. CLKIN generates the internal 'C80 clocks to which all processor functions (except the frame timers) are synchronous.
CLKOUT	O	Local output clock. CLKOUT provides a way to synchronize external circuitry to internal timings. All 'C80 output signals (except the VC signals) are synchronous to this clock.
EINT1, EINT2, EINT3	I	Edge-triggered interrupts. $\overline{\text{EINT1}}$, $\overline{\text{EINT2}}$ and $\overline{\text{EINT3}}$ allow external devices to interrupt the master processor (MP) on one of three interrupt levels ($\overline{\text{EINT1}}$ is the highest priority). The interrupts are rising-edge triggered. $\overline{\text{EINT3}}$ also serves as an unhalt signal. If the MP is powered-up halted, the first rising edge on $\overline{\text{EINT3}}$ causes the MP to unhalt and fetch its reset vector (the $\overline{\text{EINT3}}$ interrupt-pending bit is not set in this case).
$\overline{\text{LINT4}}$	I	Level-triggered interrupt. $\overline{\text{LINT4}}$ provides an active-low level-triggered interrupt to the MP. Its priority falls below that of the edge-triggered interrupts. Any interrupt request should remain low until it is recognized by the 'C80.
RESET	I	Reset. RESET is driven low to reset the 'C80 (all processors). During reset, all internal registers are set to their initial state and all outputs are driven to their inactive or high-impedance levels. During the rising edge of RESET, the MP reset mode and the 'C80's operating endian mode are determined by the levels of HREQ and UTIME pins, respectively.
$\overline{\text{XPT2}}-\overline{\text{XPT0}}$	I	External packet transfer. $\overline{\text{XPT2}}-\overline{\text{XPT0}}$ are used by external devices to request a high-priority XPT by the TC.
EMULATION CONTROL		
EMU0, EMU1‡	I/O	Emulation pins. EMU0 and EMU1 are used to support emulation host interrupts, special functions targeted at a single processor, and multiprocessor halt-event communications.
TCK‡	I	Test clock. TCK provides the clock for the 'C80 IEEE-1149.1 logic, allowing it to be compatible with other IEEE-1149.1 devices, controllers, and test equipment designed for different clock rates.
TDI‡	I	Test data input. TDI provides input data for all IEEE-1149.1 instructions and data scans of the 'C80.
TDO	O	Test data output. TDO provides output data for all IEEE-1149.1 instructions and data scans of the 'C80.
TMS‡	I	Test-mode select. TMS controls the IEEE-1149.1 state machine.
$\overline{\text{TRST}}§$	I	Test reset. $\overline{\text{TRST}}$ resets the 'C80 IEEE-1149.1 module. When low, all boundary-scan logic is disabled, allowing normal 'C80 operation.

† I = input, O = output, Z = high-impedance

‡ This pin has an internal pullup and can be left unconnected during normal operation.

§ This pin has an internal pulldown and can be left unconnected during normal operation.

¶ For proper operation, all V_{DD} and V_{SS} pins must be connected externally.



Terminal Functions (Continued)

TERMINAL NAME	TYPE†	DESCRIPTION
VIDEO INTERFACE		
CAREA0, CAREA1	O	Composite area. CAREA0 and CAREA1 define a special area such as an overscan boundary. This area represents the logical OR of the internal horizontal and vertical area signals.
$\overline{\text{CBLNK0}}/\overline{\text{VBLNK0}},$ $\overline{\text{CBLNK1}}/\overline{\text{VBLNK1}}$	O	Composite blanking/vertical blanking. Each of $\overline{\text{CBLNK0}}/\overline{\text{VBLNK0}}$ and $\overline{\text{CBLNK1}}/\overline{\text{VBLNK1}}$ provides one of two blanking functions, depending on the configuration of the CSYNC/HBLNK pin: Composite blanking disables pixel display/capture during both horizontal and vertical retrace periods and is enabled when $\overline{\text{CSYNC}}$ is selected for composite-sync video systems. Vertical blanking disables pixel display/capture during vertical retrace periods and is enabled when HBLNK is selected for separate-sync video systems. Following reset, $\overline{\text{CBLNK0}}/\overline{\text{VBLNK0}}$ and $\overline{\text{CBLNK1}}/\overline{\text{VBLNK1}}$ are configured as $\overline{\text{CBLNK0}}$ and $\overline{\text{CBLNK1}}$, respectively.
$\overline{\text{CSYNC0}}/\overline{\text{HBLNK0}},$ $\overline{\text{CSYNC1}}/\overline{\text{HBLNK1}}$	I/O/Z	Composite sync/horizontal blanking. $\overline{\text{CSYNC0}}/\overline{\text{HBLNK0}}$ and $\overline{\text{CSYNC1}}/\overline{\text{HBLNK1}}$ can be programmed for one of two functions: Composite sync is for use on composite-sync video systems and can be programmed as an input, output, or high-impedance signal. As an input, the 'C80 extracts horizontal and vertical sync information from externally generated active-low sync pulses. As an output, the active-low composite-sync pulses are generated from either external HSYNC and VSYNC signals or the 'C80's internal video timers. In the high-impedance state, the pin is neither driven nor allowed to drive circuitry. Horizontal blank disables pixel display/capture during horizontal retrace periods in separate-sync video systems and can be used as an output only. Immediately following reset, $\overline{\text{CSYNC0}}/\overline{\text{HBLNK0}}$ and $\overline{\text{CSYNC1}}/\overline{\text{HBLNK1}}$ are configured as high-impedance $\overline{\text{CSYNC0}}$ and $\overline{\text{CSYNC1}}$, respectively.
FCLK0, FCLK1	I	Frame clock. FCLK0 and FCLK1 are derived from the external video system's dotclock and are used to drive the 'C80 video logic for frame timer 0 and frame timer 1.
$\overline{\text{HSYNC0}},$ $\overline{\text{HSYNC1}}$	I/O/Z	Horizontal sync. $\overline{\text{HSYNC0}}$ and $\overline{\text{HSYNC1}}$ control the video system. They can be programmed as input, output, or high impedance signals. As an input, HSYNC synchronizes the video timer to externally generated horizontal sync pulses. As an output, HSYNC is an active-low horizontal sync pulse generated by the 'C80 on-chip frame timer. In the high-impedance state, the pin is not driven, and no internal synchronization is allowed to occur. Immediately following reset, $\overline{\text{HSYNC0}}$ and $\overline{\text{HSYNC1}}$ are in the high-impedance state.
SCLK0, SCLK1	I	Serial data clock. SCLK0 and SCLK1 are used by the 'C80 shift register transfer (SRT) controller to track the VRAM tap point when using midline reload. SCLK0 and SCLK1 should be the same signals that clock the serial register on the VRAMs controlled by frame timer 0 and frame timer 1, respectively.
$\overline{\text{VSYNC0}},$ $\overline{\text{VSYNC1}}$	I/O/Z	Vertical sync. $\overline{\text{VSYNC0}}$ and $\overline{\text{VSYNC1}}$ control the video system. They can be programmed as inputs, outputs, or high-impedance signals. As inputs, $\overline{\text{VSYNCx}}$ synchronize the frame timer to externally generated vertical-sync pulses. As outputs, $\overline{\text{VSYNCx}}$ are active-low vertical-sync pulses generated by the 'C80 on-chip frame timer. In the high-impedance state, the pin is not driven and no internal synchronization is allowed to occur. Immediately following reset, $\overline{\text{VSYNCx}}$ is in the high-impedance state.
POWER		
V_{SS}^{\ddagger}	I	Ground. Electrical ground inputs
V_{DD}^{\ddagger}	I	Power. Nominal 3.3-V power supply inputs
MISCELLANEOUS		
NC		No connect serves as an alignment key or is for factory use and must be left unconnected.

† I = input, O = output, Z = high-impedance

‡ This pin has an internal pullup and can be left unconnected during normal operation.

§ This pin has an internal pulldown and can be left unconnected during normal operation.

¶ For proper operation, all V_{DD} and V_{SS} pins must be connected externally.

SMJ320C80 DIGITAL SIGNAL PROCESSOR

SGUS025B - AUGUST 1998 - REVISED JUNE 2002

architecture

Figure 1 shows the major components of the 'C80: the master processor (MP), the parallel digital signal processors (PPs), the transfer controller (TC), and the IEEE-1149.1 emulation interface. Shared access to on-chip RAM is achieved through the crossbar. Crossbar connections are represented by \circ . Each PP can perform three accesses per cycle through its local (L), global (G), and instruction (I) ports. The MP can access two RAMs per cycle through its crossbar/data (C/D) and instruction (I) ports, and the TC can access one RAM through its crossbar interface. Up to nine simultaneous accesses are supported in each cycle. Addresses can be changed every cycle, allowing the crossbar matrix to be changed on a cycle-by-cycle basis. Contention between processors for the same RAM in the same cycle is resolved by a round-robin priority scheme. In addition to the crossbar, a 32-bit data path exists between the MP and the TC and VC. This allows the MP to access TC control registers that are memory-mapped into the MP memory space.

The 'C80 has a 4G-byte address space as shown in Figure 2. The lower 32M bytes are used to address internal RAM and memory-mapped registers.

architecture (continued)

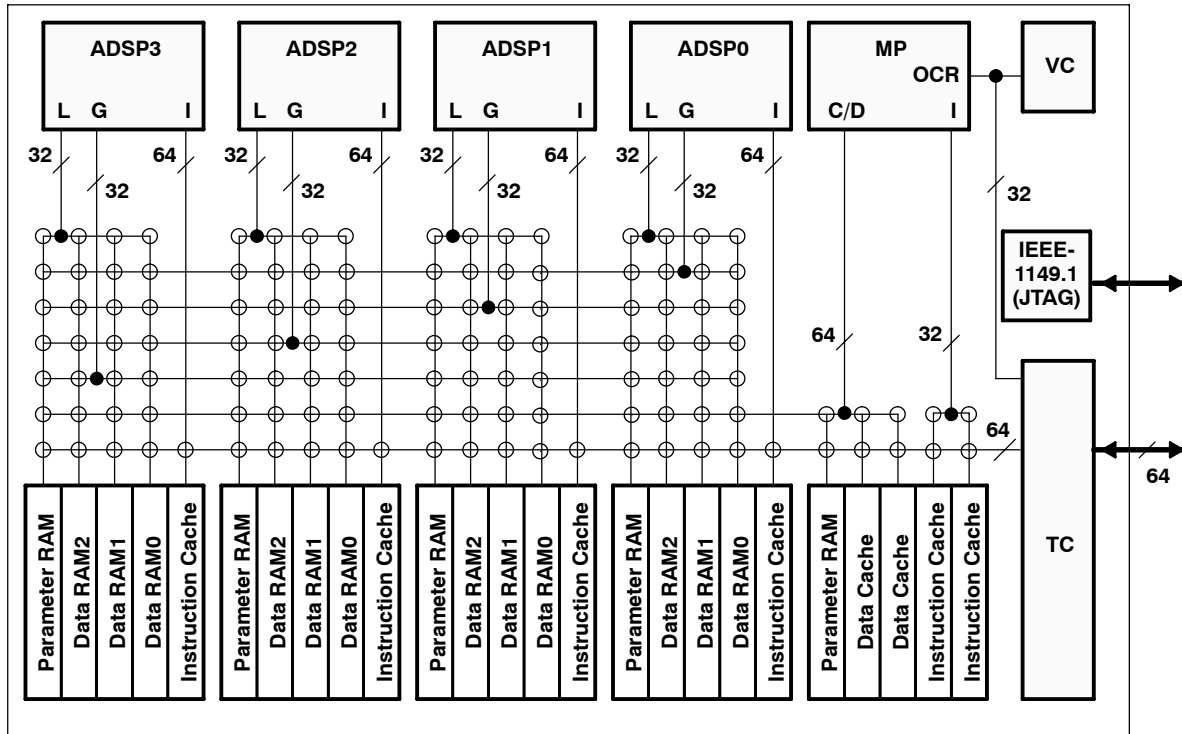

- L Local port
- G Global port
- I Instruction port
- C/D Crossbar/data port

Figure 1. Block Diagram Showing Data Paths

SMJ320C80 DIGITAL SIGNAL PROCESSOR

SGUS025B - AUGUST 1998 - REVISED JUNE 2002

architecture (continued)

External Memory (4064M bytes)	0xFFFFFFFF	ADSP3 Parameter RAM (2K bytes)	0x010037FF
		Reserved (2K bytes)	0x01003000 0x01002FFF
Reserved (8063K bytes)	0x02000000	ADSP2 Parameter RAM (2K bytes)	0x01002800 0x010027FF
	0x01FFFFFF	Reserved (2K bytes)	0x01002000 0x01001FFF
Memory-Mapped VC Registers (512 bytes)	0x01820400 0x018203FF	ADSP1 Parameter RAM (2K bytes)	0x01001800 0x010017FF
Memory-Mapped TC Registers (512 bytes)	0x01820200 0x018201FF	Reserved (2K bytes)	0x01001000 0x01000FFF
Reserved (28K bytes)	0x01820000 0x0181FFFF	ADSP0 Parameter RAM (2K bytes)	0x01000800 0x010007FF
MP Instruction Cache (4K bytes)	0x01819000 0x01818FFF	Reserved (16338K bytes)	0x01000000 0x00FFFFFF
Reserved (28K bytes)	0x01818000 0x01817FFF	ADSP3 Data RAM2 (2K bytes)	0x0000B800 0x0000B7FF
MP Data Cache (4K bytes)	0x01811000 0x01810FFF	Reserved (2K bytes)	0x0000B000 0x0000AFFF
Reserved (32K bytes)	0x01810000 0x0180FFFF	ADSP2 Data RAM2 (2K bytes)	0x0000A800 0x0000A7FF
ADSP3 Instruction Cache (2K bytes)	0x01808000 0x01807FFF	Reserved (2K bytes)	0x0000A000 0x00009FFF
Reserved (6K bytes)	0x01807800 0x018077FF	ADSP1 Data RAM2 (2K bytes)	0x00009800 0x000097FF
ADSP2 Instruction Cache (2K bytes)	0x01806000 0x01805FFF	Reserved (2K bytes)	0x00009000 0x00008FFF
Reserved (6K bytes)	0x01805800 0x018057FF	ADSP0 Data RAM2 (2K bytes)	0x00008800 0x000087FF
ADSP1 Instruction Cache (2K bytes)	0x01804000 0x01803FFF	Reserved (16K bytes)	0x00008000 0x00007FFF
Reserved (6K bytes)	0x01803800 0x018037FF	ADSP3 Data RAM1 (2K bytes)	0x00004000 0x00003FFF
ADSP0 Instruction Cache (2K bytes)	0x01802000 0x01801FFF	ADSP3 Data RAM0 (2K bytes)	0x00003800 0x000037FF
Registers (8132K bytes)	0x01801800 0x018017FF	ADSP2 Data RAM1 (2K bytes)	0x00003000 0x00002FFF
		ADSP2 Data RAM0 (2K bytes)	0x00002800 0x000027FF
MP Parameter RAM (2K bytes)	0x01010800 0x010107FF	ADSP1 Data RAM1 (2K bytes)	0x00002000 0x00001FFF
Registers (50K bytes)	0x01010000 0x0100FFFF	ADSP1 Data RAM0 (2K bytes)	0x00001800 0x000017FF
	0x01003800	ADSP0 Data RAM1 (2K bytes)	0x00001000 0x00000FFF
		ADSP0 Data RAM0 (2K bytes)	0x00000800 0x000007FF
			0x00000000

Figure 2. Memory Map



master processor (MP) architecture

The master processor (MP) is a 32-bit RISC processor with an integral IEEE-754 floating-point unit. The MP is designed for effective execution of C code and is capable of performing at well over 130000 dhrystones/s. Major tasks which the MP typically performs are:

- Task control and user interface
- Information processing and analysis
- IEEE-754 floating point (including graphics transforms)

MP functional block diagram

Figure 3 shows a block diagram of the master processor. Key features of the MP include:

- 32-bit RISC processor
 - Load/store architecture
 - Three operand arithmetic and logical instructions
- 4K-byte instruction cache and 4K-byte data cache
 - Four-way set associative
 - Least-recently-used (LRU) information replacement
 - Data writeback
- 4K-byte noncached parameter RAM
- Thirty-one 32-bit general-purpose registers
- Register and accumulator scoreboard
- 15-bit or 32-bit immediate constants
- 32-bit byte addressing
- Scalable timer
- Leftmost-one and rightmost-one logic
- IEEE-754 floating-point hardware
 - Four double-precision floating-point vector accumulators
 - Vector floating-point instructions
 - Floating-point operation and parallel load or store
 - Multiply and accumulate
- High performance
 - 50 million instructions per second (MIPS)
 - 100 million floating-point operations per second (MFLOPS)
 - Over 130000 dhrystones/s

SMJ320C80 DIGITAL SIGNAL PROCESSOR

SGUS025B - AUGUST 1998 - REVISED JUNE 2002

MP functional block diagram (continued)

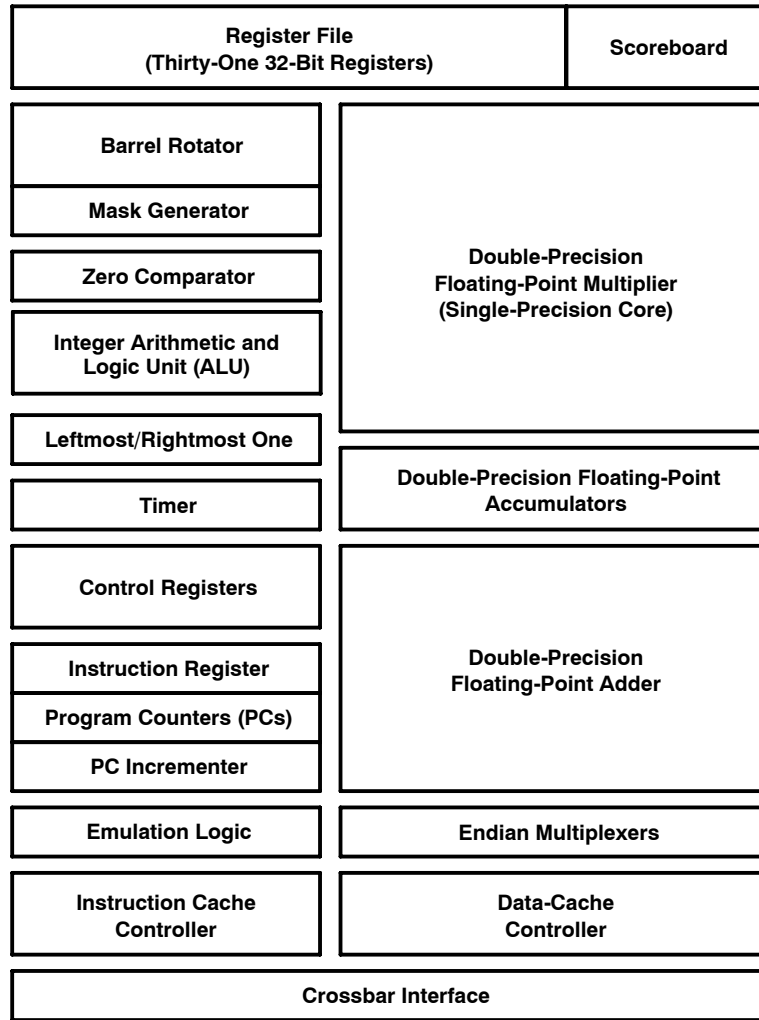

Figure 3. MP Block Diagram

MP general-purpose registers

The MP contains 31 32-bit general-purpose registers, R1–R31. Register R0 always reads as zero and writes to it are discarded. Double-precision values are always stored in an even-odd register pair with the higher-numbered register always holding the sign bit and exponent. The R0/R1 pair is not available for this use. A scoreboard keeps track of which registers are awaiting loads or the result of a previous instruction and stalls the instruction pipeline until the register contains valid data. As a recommended software convention, R1 is typically used as a stack pointer and R31 as a return-address link register.

Figure 4 shows the MP general-purpose registers.

MP double-precision floating-point accumulators

There are four double-precision floating-point registers (see Figure 8) to accumulate intermediate floating-point results.

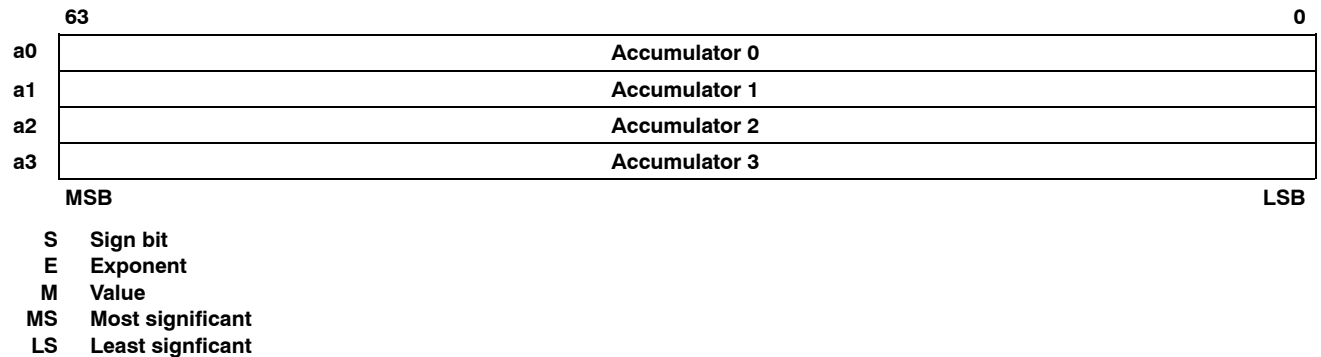

Figure 8. Double-Precision Floating-Point Accumulators

MP control registers

In addition to the general-purpose registers, there are a number of control registers that are used to represent the state of the processor. Table 1 shows the control register numbers of the accessible registers.

Table 1. Control Register Numbers

NUMBER	NAME	DESCRIPTION	NUMBER	NAME	DESCRIPTION
0x0000	EPC	Exception Program Counter	0x0015-0x001F	—	Reserved
0x0001	EIP	Exception Instruction Pointer	0x0020	SYSSTK	System Stack Pointer
0x0002	CONFIG	Configuration	0x0021	SYSTMP	System Temporary Register
0x0003	—	Reserved	0x0022-0x002F	—	Reserved
0x0004	INTPEN	Interrupt Pending Register	0x0030	MPC	Emulator Exception Program Counter
0x0005	—	Reserved	0x0031	MIP	Emulator Exception Instruction Pointer
0x0006	IE	Interrupt Enable Register	0x0032	—	Reserved
0x0007	—	Reserved	0x0033	ECOMCNTL	Emulator Communication Control
0x0008	FPST	Floating-Point Status	0x0034	ANASTAT	Emulation Analysis Status Register
0x0009	—	Reserved	0x0035-0x0038	—	Reserved
0x000A	PPERROR	PP Error Register	0x0039	BRK1	Emulation Breakpoint 1 Register
0x000B	—	Reserved	0x003A	BRK2	Emulation Breakpoint 2 Register
0x000C	—	Reserved	0x003B-0x01FF	—	Reserved
0x000D	PKTREQ	Packet-Transfer Request Register	0x0200 - 0x020F	iCACHET	Instruction Cache Tags 0 to 15
0x000E	TCOUNT	Current Counter Value	0x0300	iCACHEL	Instruction Cache LRU Register
0x000F	TSCALE	Counter Reload Value	0x0400-0x040F	dCACHET	Data Cache Tags 0 to 15
0x0010	FLTOP	Faulting Operation	0x0500	dCACHEL	Data Cache LRU Register
0x0011	FLTADR	Faulting Address	0x4000	IN0P	Vector Load Pointer 0
0x0012	FLT TAG	Faulting Tag	0x4001	IN1P	Vector Load Pointer 1
0x0013	FLTDTL	Faulting Data (low)	0x4002	OUTP	Vector Store Pointer
0x0014	FLTDTH	Faulting Data (high)			

SMJ320C80 DIGITAL SIGNAL PROCESSOR

SGUS025B - AUGUST 1998 - REVISED JUNE 2002

MP pipeline registers

The MP uses a three-stage fetch, execute, access (FEA) pipeline. The primary pipeline registers are manipulated implicitly by branch and trap instructions and are not accessible by the user. The exception and emulation pipeline registers are user-accessible as control registers. All pipeline registers are 32 bits.

	Program Execution Mode		
	Normal	Exception	Emulation
Program Counter	PC	EPC	MPC
Instruction Pointer	IP	EIP	MIP
Instruction Register	IR		

- Instruction register (IR) contains the instruction being executed.
- Instruction pointer (IP) points to the instruction being executed.
- Program counter (PC) points to the instruction being fetched.
- Exception/emulator instruction pointer (EIP/MIP) points to the instruction that would have been executed had the exception / emulation trap not occurred.
- Exception/emulator program counter (EPC/MPC) points to the instruction to be fetched on returning from the exception/emulation trap.

Figure 9. MP FEA Pipeline Registers

configuration (CONFIG) register (0x0002)

The CONFIG register controls or reflects the state of certain options as shown in Figure 10.

3	3	2	2	2	2	2	2	2	2	2	1	1	1	1	1	1	1	1	1	1	9	8	7	6	5	4	3	2	1	0
E	R	T	H	X	Reserved					Type	Reserved			Release	Reserved															

- E** Endian mode; 0 = big-endian, 1 = little-endian, read only
- R** PPData RAM round robin; 0 = fixed, 1 = variable, read/write
- T** TC packet transfer (PT) round robin; 0 = variable, 1 = fixed, read/write
- H** High priority MP events; 0 = disabled, 1 = enabled, read/write
- X** Externally initiated packet transfers; 0 = disabled, 1 = enabled, read/write
- Type** Number of PPs in device, read only
- Release** SMJ320C80 version number

Figure 10. CONFIG Register

interrupt-enable (IE) register (0x0006)

The IE register contains enable bits for each of the interrupts/traps as shown in Figure 11. The global-interrupt-enable (ie) bit and the appropriate individual interrupt-enable bit must be set in order for an interrupt to occur.

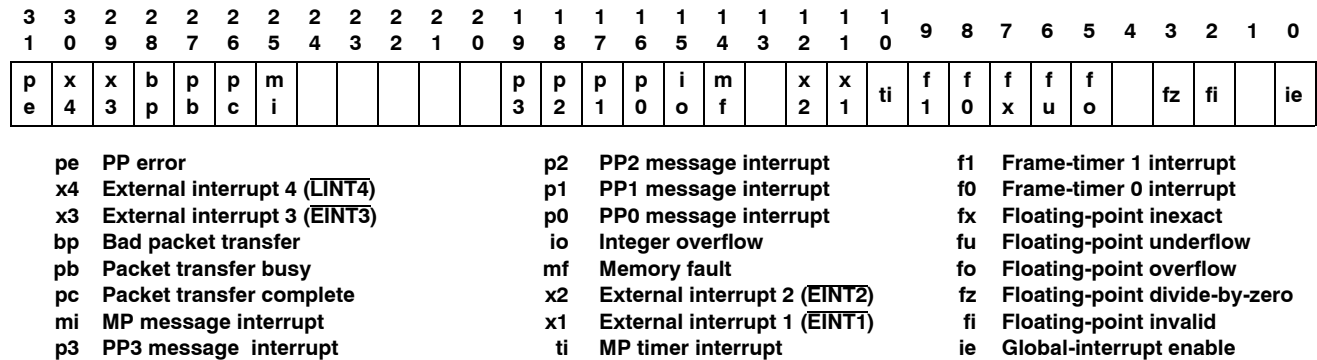

Figure 11. IE Register

interrupt-pending (INTPEN) register (0x0004)

The bits in INTPEN register show the current state of each interrupt/trap. Pending interrupts do not occur unless the ie bit and corresponding interrupt-enable bit are set. Software must write a 1 to the appropriate INTPEN bit to clear an interrupt. Figure 12 shows the INTPEN register locations.

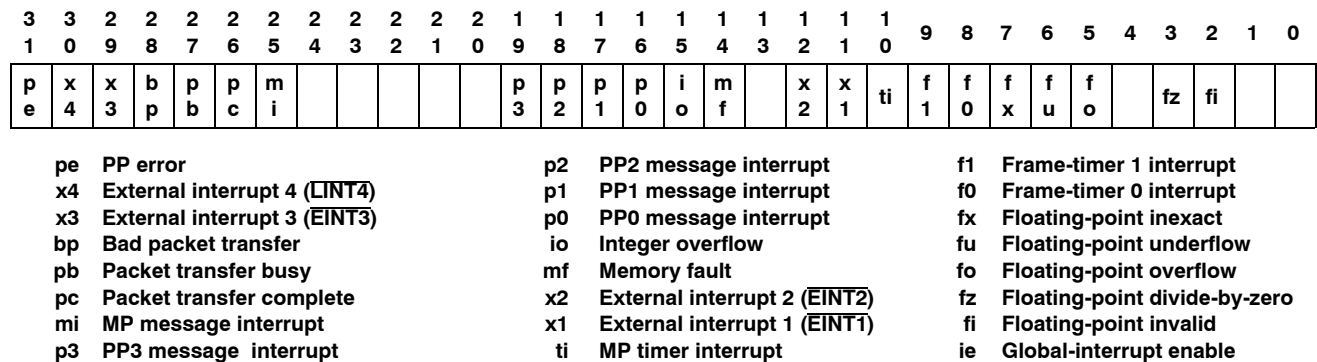

Figure 12. INTPEN Register

SMJ320C80 DIGITAL SIGNAL PROCESSOR

SGUS025B - AUGUST 1998 - REVISED JUNE 2002

floating-point status (FPST) register (0x0008)

FPST contains status and control information for the floating-point unit (FPU) as shown in Figure 13. Bits 17–21 are read/write FPU control bits. Bits 22–26 are read/write accumulated status bits. All other bits show the status of the last FPU instruction to complete and are read only.

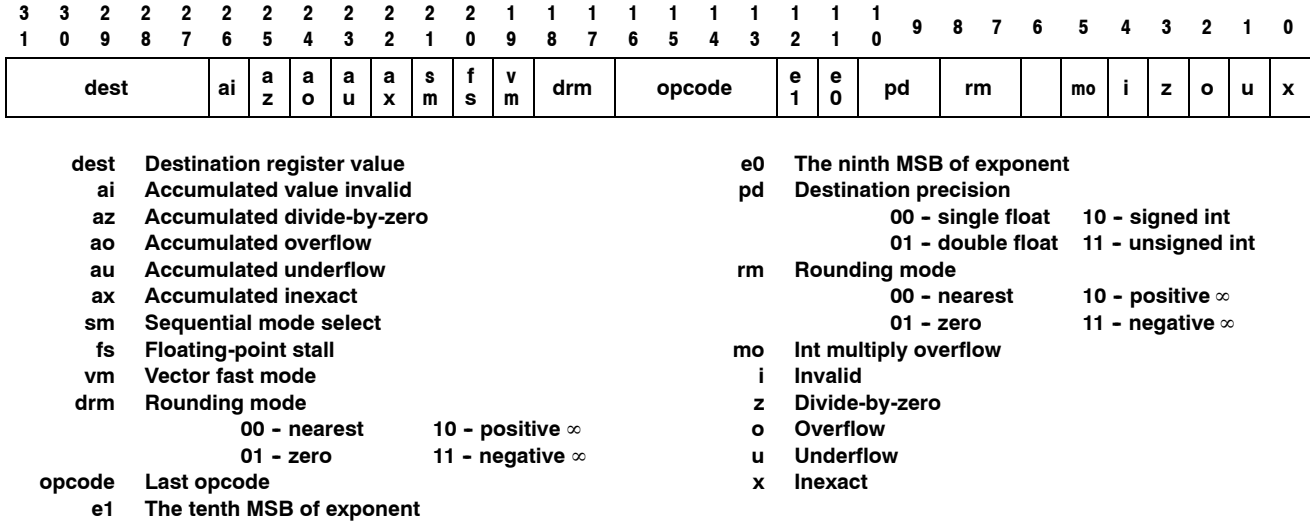

Figure 13. FPST Register

PP error (PPEROR) register (0x000A)

The bits in the PPEROR register reflect parallel processor errors (see Figure 14). The MP can use these when a PP error interrupt occurs to determine the cause of the error.

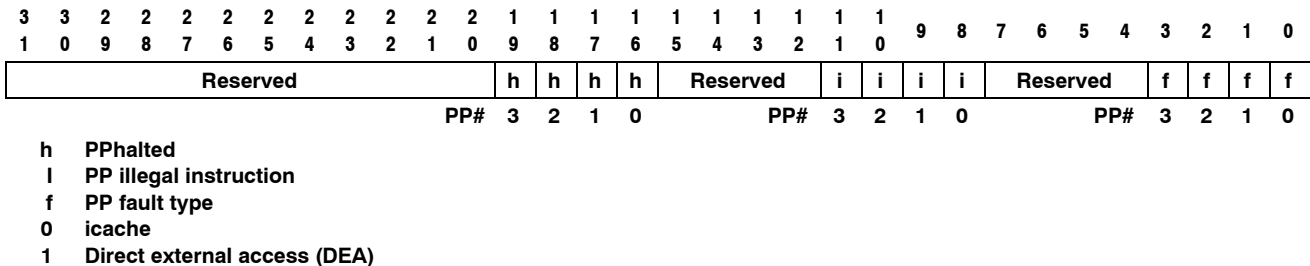
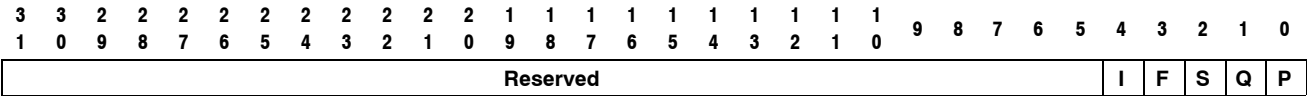

Figure 14. PPEROR Register

packet-transfer request (PKTREQ) register (0x000D)

PKTREQ controls the submission and priority of packet-transfer requests as shown in Figure 15. It also indicates that a packet transfer is currently active.



- I Immediate (urgent) priority selected
- F High (foreground) priority selected
- S Suspend packet transfer
- Q Packet transfer queued; read only
- P Submit packet-transfer request

Figure 15. PKTREQ Register

memory-fault registers

The five read-only memory-fault registers contain information about memory address exceptions, as shown in Figure 16.

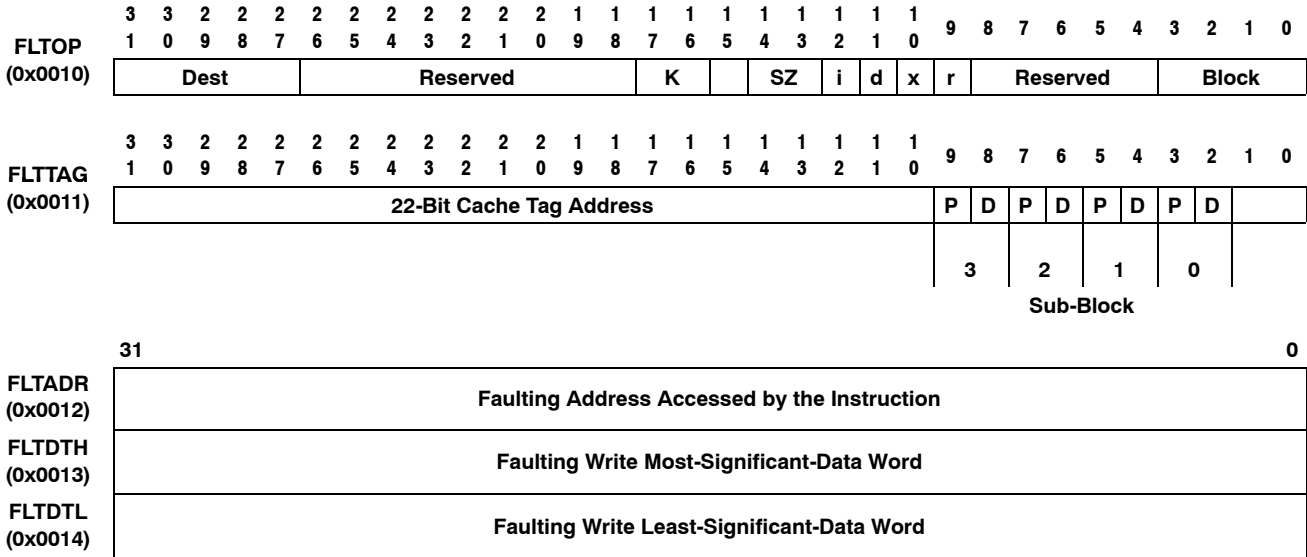

- | | |
|---|------------------------------------|
| Dest Destination Register Number | i MP icache fault |
| K Kind of Operation: | d MP dcache fault |
| 00 - load | x DEA Fault |
| 01 - unsigned load | r Modified return sequence |
| 10 - store | Block Faulting block number |
| 11 - cache flush/clean | P Sub-block is present. |
| SZ Size of Data: | D Dirty bit set |
| 00 - 8-bit | |
| 01 - 16-bit | |
| 10 - 32-bit | |
| 11 - 64-bit | |

Figure 16. Memory-Fault Registers



SMJ320C80 DIGITAL SIGNAL PROCESSOR

SGUS025B - AUGUST 1998 - REVISED JUNE 2002

MP cache registers

The ILRU and DLRU registers track least-recently-used (LRU) information for the sixteen instruction-cache and sixteen data-cache blocks. The ITAGxx registers contain block addresses and the present flags for each sub-block. DTAGxx registers are identical to ITAGxx registers but include dirty bits for each sub-block. Figure 17 shows the cache registers.

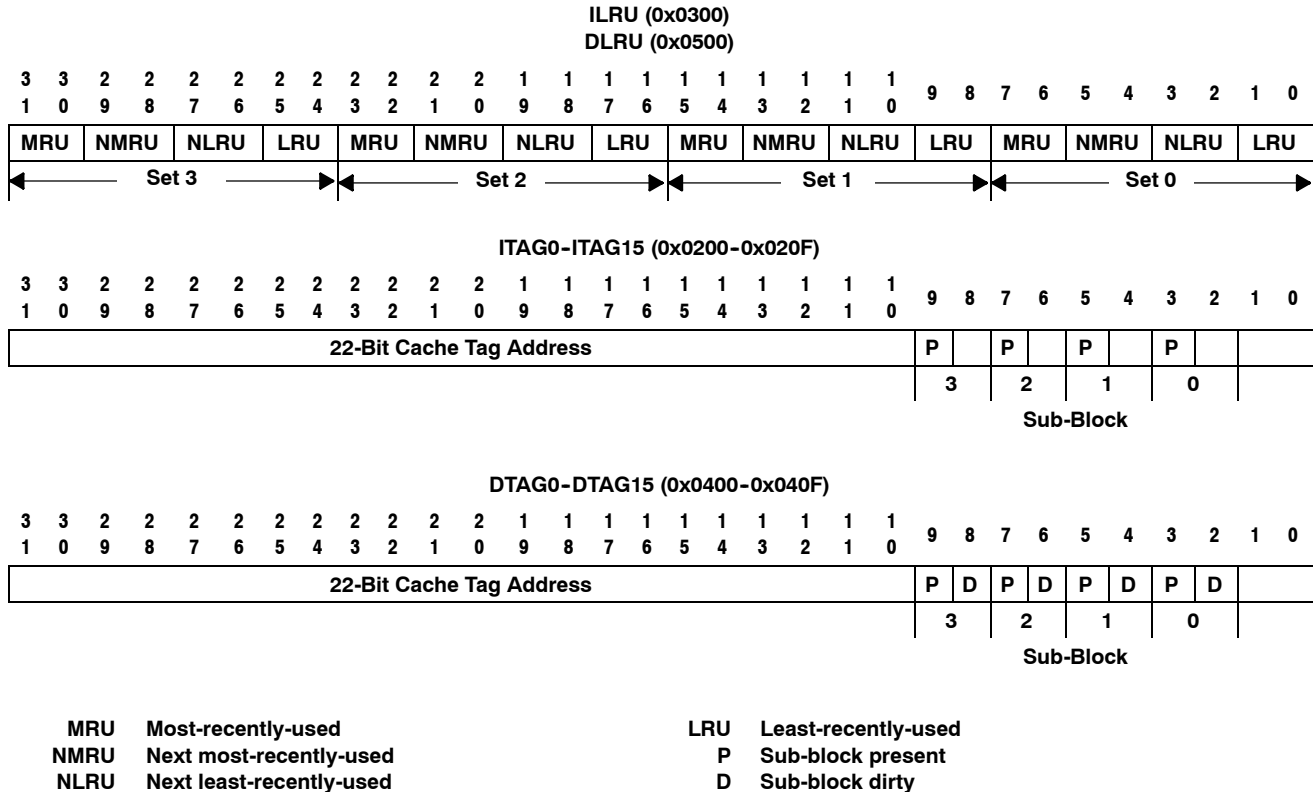

Figure 17. Cache Registers

MP cache architecture

The MP contains two four-way set-associative, 4K caches for instructions and data. Each cache is divided into four sets with four blocks in each set. Each block represents 256 bytes of contiguous instructions or data and is aligned to a 256-byte address boundary. Each block is partitioned into four sub-blocks that each contain sixteen 32-bit words and are aligned to 64-byte boundaries within the block. Cache misses cause one sub-block to be loaded into cache. Figure 18 shows the cache architecture for one of the four sets in each cache. Figure 19 shows how addresses map into the cache using the cache tags and address bits.

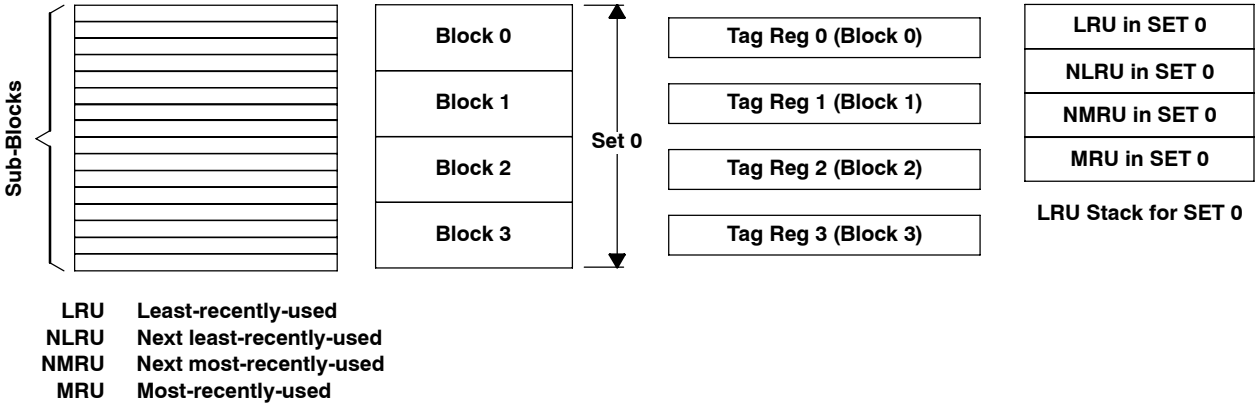

Figure 18. MP Cache Architecture (x4 Sets)

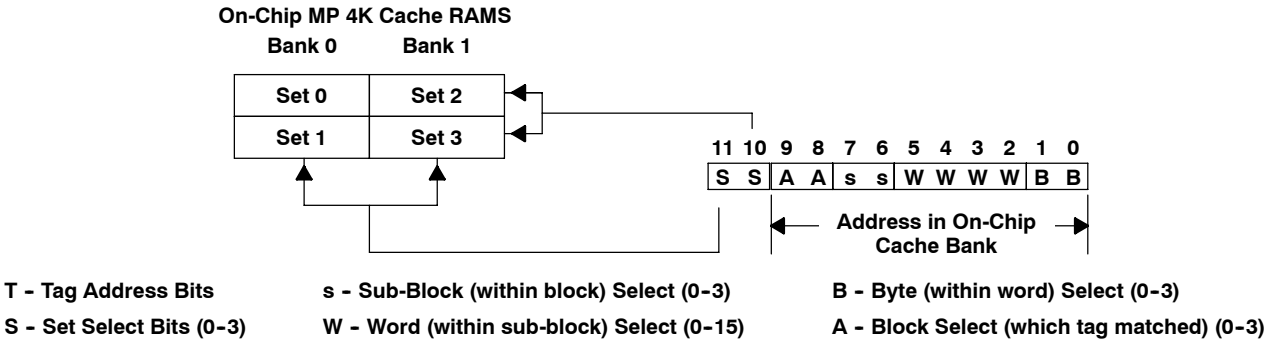
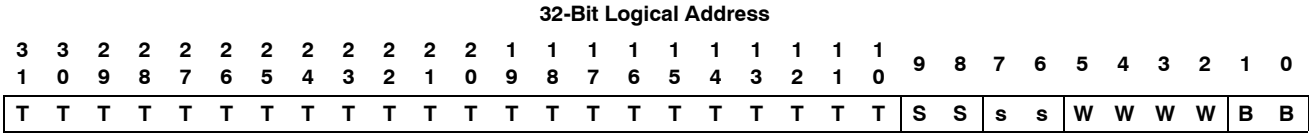

Figure 19. MP Cache Addressing

SMJ320C80 DIGITAL SIGNAL PROCESSOR

SGUS025B - AUGUST 1998 - REVISED JUNE 2002

MP parameter RAM

The parameter RAM is a noncachable, 2K-byte, on-chip RAM that contains MP interrupt vectors, MP-requested TC task buffers, and a general-purpose area. Figure 20 shows the parameter RAM address map.

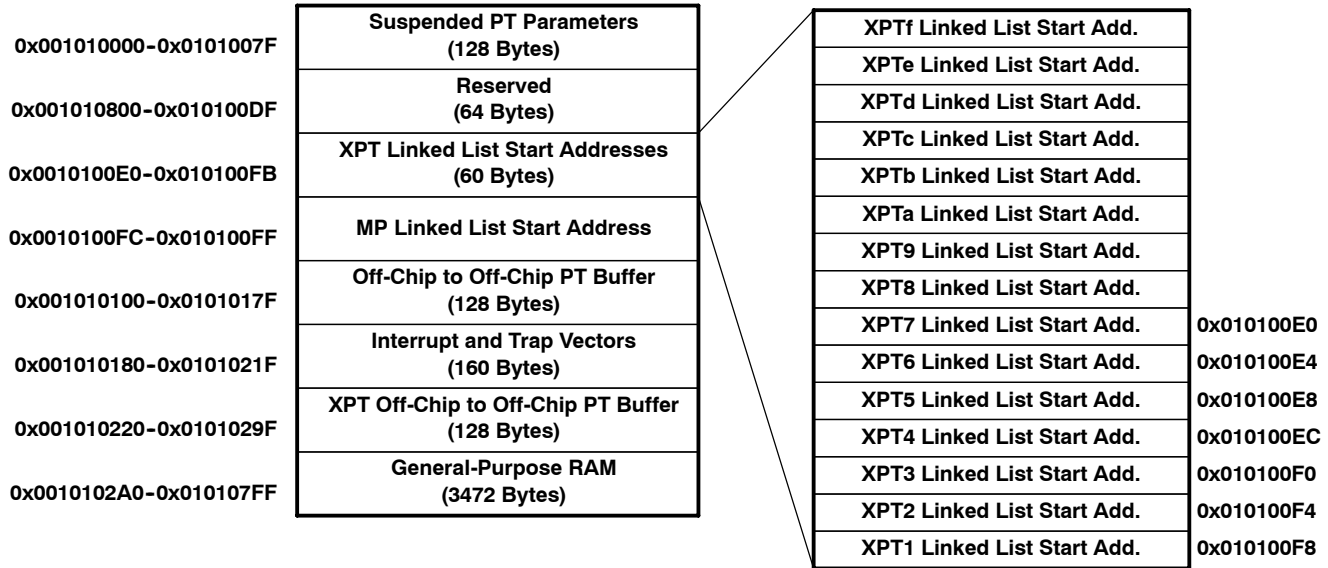

Figure 20. MP Parameter RAM

MP interrupt vectors

Table 2 and Table 3 show the MP interrupts and traps and their vector addresses.

Table 2. Maskable Interrupts

IE BIT (TRAP#)	NAME	VECTOR ADDRESS	MASKABLE INTERRUPT
0	ie	0x01010180	
2	fi	0x01010188	Floating-point invalid
3	fz	0x0101018C	Floating-point divide-by-zero
5	fo	0x01010194	Floating-point overflow
6	fu	0x01010198	Floating-point underflow
7	fx	0x0101019C	Floating-point inexact
8	f0	0x010101A0	Reserved
9	f1	0x010101A4	Reserved
10	ti	0x010101A8	MP timer interrupt
11	x1	0x010101AC	External interrupt 1 (EINT1)
12	x2	0x010101B0	External interrupt 2 (EINT2)
14	mf	0x010101B8	Memory fault
15	io	0x010101BC	Integer overflow
16	p0	0x010101C0	PP0 message interrupt
17	p1	0x010101C4	PP1 message interrupt
18	p2	0x010101C8	Reserved
19	p3	0x010101CC	Reserved
25	mi	0x010101E4	MP message interrupt
26	pc	0x010101E8	Packet-transfer complete
27	pb	0x010101EC	Packet-transfer busy
28	bp	0x010101F0	Bad packet transfer
29	x3	0x010101F4	External interrupt 3 (EINT3)
30	x4	0x010101F8	External interrupt 4 (LINT4)
31	pe	0x010101FC	PP error

Table 3. Nonmaskable Traps

TRAP NUMBER	NAME	VECTOR ADDRESS	NONMASKABLE TRAP
32	e1	0x01010200	Emulator trap1 (reserved)
33	e2	0x01010204	Emulator trap2 (reserved)
34	e3	0x01010208	Emulator trap3 (reserved)
35	e4	0x0101020C	Emulator trap4 (reserved)
36	fe	0x01010210	Floating-point error
37		0x01010214	Reserved
38	er	0x01010218	Illegal MP instruction
39		0x0101021C	Reserved
72 to 415		0x010102A0 to 0x010107FC	System- or user-defined

SMJ320C80 DIGITAL SIGNAL PROCESSOR

SGUS025B - AUGUST 1998 - REVISED JUNE 2002

MP opcode formats

The three basic classes of MP instruction opcodes are: short immediate, three register, and long immediate. Figure 21 shows the opcode structure for each class of instruction.

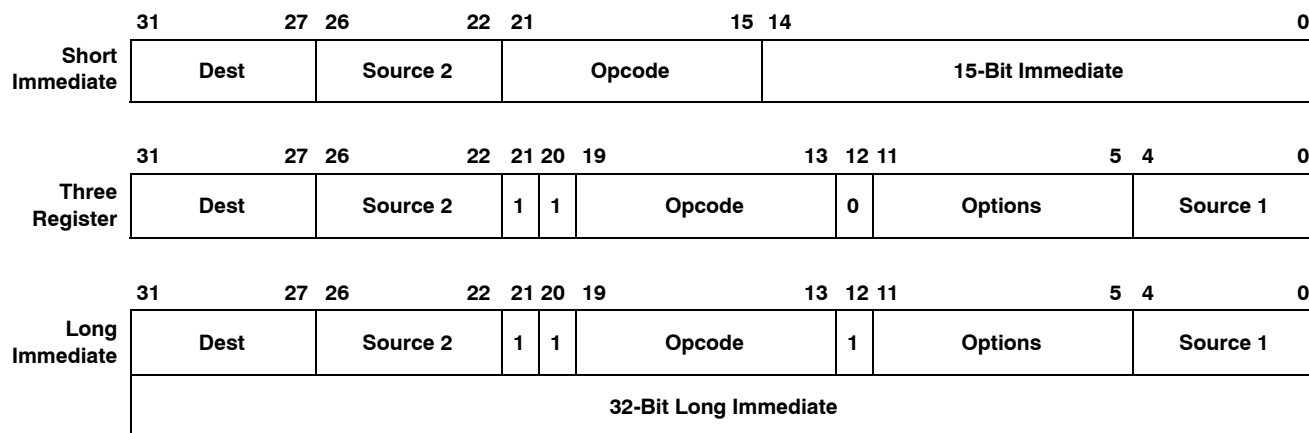

Figure 21. MP Opcode Formats

MP opcode summary

Table 4 through Table 6 show the opcode formats for the MP. Table 7 summarizes the master processor instruction set.



MP opcode summary (continued)

Table 4. Short-Immediate Opcodes

	3	3	2	2	2	2	2	2	2	2	2	1	1	1	1	1	1	1	1	0	0	0	0	0	0	0	0	0	0	0	0		
	1	0	9	8	7	6	5	4	3	2	1	0	9	8	7	6	5	4	3	2	1	0	9	8	7	6	5	4	3	2	1	0	
illop0	Dest		Source									0	0	0	0	0	0	Unsigned Immediate															
trap	-	-	-	-	E	-									0	0	0	0	0	0	0	1	Unsigned Trap Number										
cmnd	-					-					0	0	0	0	0	1	0	Unsigned Immediate															
rdcr	Dest		-									0	0	0	0	1	0	0	Unsigned Control Register Number														
swcr	Dest		Source									0	0	0	0	1	0	1	Unsigned Control Register Number														
brcr	-					-					0	0	0	0	1	1	0	Unsigned Control Register Number															
shift.dz	Dest		Source									0	0	0	1	0	0	0	-	-	-	i	n	Endmask			Rotate						
shift.dm	Dest		Source									0	0	0	1	0	0	1	-	-	-	i	n	Endmask			Rotate						
shift.ds	Dest		Source									0	0	0	1	0	1	0	-	-	-	i	n	Endmask			Rotate						
shift.ez	Dest		Source									0	0	0	1	0	1	1	-	-	-	i	n	Endmask			Rotate						
shift.em	Dest		Source									0	0	0	1	1	0	0	-	-	-	i	n	Endmask			Rotate						
shift.es	Dest		Source									0	0	0	1	1	0	1	-	-	-	i	n	Endmask			Rotate						
shift.iz	Dest		Source									0	0	0	1	1	1	0	-	-	-	i	n	Endmask			Rotate						
shift.im	Dest		Source									0	0	0	1	1	1	1	-	-	-	i	n	Endmask			Rotate						
and.tt	Dest		Source2									0	0	1	0	0	0	1	Unsigned Immediate														
and.tf	Dest		Source2									0	0	1	0	0	1	0	Unsigned Immediate														
and.ft	Dest		Source2									0	0	1	0	1	0	0	Unsigned Immediate														
xor	Dest		Source2									0	0	1	0	1	1	0	Unsigned Immediate														
or.tt	Dest		Source2									0	0	1	0	1	1	1	Unsigned Immediate														
and.ff	Dest		Source2									0	0	1	1	0	0	0	Unsigned Immediate														
xnor	Dest		Source2									0	0	1	1	0	0	1	Unsigned Immediate														
or.tf	Dest		Source2									0	0	1	1	0	1	1	Unsigned Immediate														
or.ft	Dest		Source2									0	0	1	1	1	0	1	Unsigned Immediate														
or.ff	Dest		Source2									0	0	1	1	1	1	0	Unsigned Immediate														
ld	Dest		Base		0	1	0	0	M	SZ	Signed Offset																						
ld.u	Dest		Base		0	1	0	1	M	SZ	Signed Offset																						
st	Source		Base		0	1	1	0	M	SZ	Signed Offset																						
dcache	-	-	-	-	F	Source2									0	1	1	1	M	0	0	Signed Offset											
bsr	Link		-									1	0	0	0	0	0	0	A	Signed Offset													
jsr	Link		Base									1	0	0	0	1	0	A	Signed Offset														
bbz	BITNUM		Source									1	0	0	1	0	0	A	Signed Offset														
bbo	BITNUM		Source									1	0	0	1	0	1	A	Signed Offset														
bcnd	Cond		Source									1	0	0	1	1	0	A	Signed Offset														
cmp	Dest		Source2									1	0	1	1	0	0	0	Signed Immediate														
add	Dest		Source2									1	0	1	1	0	0	U	Signed Immediate														
sub	Dest		Source2									1	0	1	1	0	1	U	Signed Immediate														

- Reserved bit (code as 0)
- A Annul delay slot instruction if branch taken
- E Emulation trap bit
- F Clear present flags
- i Invert endmask
- M Modify, write modified address back to register
- n Rotate sense for shifting
- SZ Size (0 = byte, 1 = halfword, 2 = word, 3 = doubleword)
- U Unsigned form

SMJ320C80 DIGITAL SIGNAL PROCESSOR

SGUS025B - AUGUST 1998 - REVISED JUNE 2002

MP opcode summary (continued)

Table 5. Long-Immediate and Three-Register Opcodes

	3	3	2	2	2	2	2	2	2	2	2	1	1	1	1	1	1	1	1	0	0	0	0	0	0	0	0	0	0	0			
	1	0	9	8	7	6	5	4	3	2	1	0	9	8	7	6	5	4	3	2	1	0	9	8	7	6	5	4	3	2	1	0	
trap	-	-	-	-	E	-	-	-	-	-	1	1	0	0	0	0	0	0	1		-	-	-	-	-	-	-	-	-	-	-	IND TR	
cmdnd	-	-	-	-	-	-	-	-	-	-	1	1	0	0	0	0	0	1	0		-	-	-	-	-	-	-	-	-	-	-	Source1	
rdcr						Dest	-	-	-	-	-	1	1	0	0	0	0	1	0	0		-	-	-	-	-	-	-	-	-	-	IND CR	
swcr						Dest	Source	-	-	-	-	-	1	1	0	0	0	0	1	0	1		-	-	-	-	-	-	-	-	-	-	IND CR
brcr	-	-	-	-	-	-	-	-	-	-	1	1	0	0	0	0	1	1	0		-	-	-	-	-	-	-	-	-	-	-	IND CR	
shift.dz						Dest	Source	-	-	-	-	-	1	1	0	0	0	1	0	0	0		i	n	Endmask	-	-	-	-	-	-	-	Rotate
shift.dm						Dest	Source	-	-	-	-	-	1	1	0	0	0	1	0	0	1		i	n	Endmask	-	-	-	-	-	-	-	Rotate
shift.ds						Dest	Source	-	-	-	-	-	1	1	0	0	0	1	0	1	0		i	n	Endmask	-	-	-	-	-	-	-	Rotate
shift.ez						Dest	Source	-	-	-	-	-	1	1	0	0	0	1	0	1	1		i	n	Endmask	-	-	-	-	-	-	-	Rotate
shift.em						Dest	Source	-	-	-	-	-	1	1	0	0	0	1	1	0	0		i	n	Endmask	-	-	-	-	-	-	-	Rotate
shift.es						Dest	Source	-	-	-	-	-	1	1	0	0	0	1	1	0	1		i	n	Endmask	-	-	-	-	-	-	-	Rotate
shift.iz						Dest	Source	-	-	-	-	-	1	1	0	0	0	1	1	1	0		i	n	Endmask	-	-	-	-	-	-	-	Rotate
shift.im						Dest	Source	-	-	-	-	-	1	1	0	0	0	1	1	1	1		i	n	Endmask	-	-	-	-	-	-	-	Rotate
and.tt						Dest	Source2	-	-	-	-	-	1	1	0	0	1	0	0	0	1		-	-	-	-	-	-	-	-	-	-	Source1
and.tf						Dest	Source2	-	-	-	-	-	1	1	0	0	1	0	0	1	0		-	-	-	-	-	-	-	-	-	-	Source1
and.ft						Dest	Source2	-	-	-	-	-	1	1	0	0	1	0	1	0	0		-	-	-	-	-	-	-	-	-	-	Source1
xor						Dest	Source2	-	-	-	-	-	1	1	0	0	1	0	1	1	0		-	-	-	-	-	-	-	-	-	-	Source1
or.tt						Dest	Source2	-	-	-	-	-	1	1	0	0	1	0	1	1	1		-	-	-	-	-	-	-	-	-	-	Source1
and.ff						Dest	Source2	-	-	-	-	-	1	1	0	0	1	1	0	0	0		-	-	-	-	-	-	-	-	-	-	Source1
xnor						Dest	Source2	-	-	-	-	-	1	1	0	0	1	1	0	0	1		-	-	-	-	-	-	-	-	-	-	Source1
or.tf						Dest	Source2	-	-	-	-	-	1	1	0	0	1	1	0	1	1		-	-	-	-	-	-	-	-	-	-	Source1
or.ft						Dest	Source2	-	-	-	-	-	1	1	0	0	1	1	1	0	1		-	-	-	-	-	-	-	-	-	-	Source1
or.ff						Dest	Source2	-	-	-	-	-	1	1	0	0	1	1	1	1	0		-	-	-	-	-	-	-	-	-	-	Source1
ld						Dest	Base	-	-	-	-	-	1	1	0	1	0	0	M	SZ		S	D	-	-	-	-	-	-	-	-	Offset	
ld.u						Dest	Base	-	-	-	-	-	1	1	0	1	0	1	M	SZ		S	D	-	-	-	-	-	-	-	-	Offset	
st						Source	Base	-	-	-	-	-	1	1	0	1	1	0	M	SZ		S	D	-	-	-	-	-	-	-	-	Offset	
dcache	-	-	-	-	F	-	-	-	-	-	Source2	-	-	-	-	-	-	-	-	-	M	0	0		0	0	-	-	-	-	-	-	Source
bsr						Link	-	-	-	-	-	1	1	1	0	0	0	0	0	0	A		-	-	-	-	-	-	-	-	-	Offset	
jsr						Link	Base	-	-	-	-	-	1	1	1	0	0	0	1	0	0	A		-	-	-	-	-	-	-	-	Offset	
bbz						BITNUM	Source	-	-	-	-	-	1	1	1	0	0	1	0	0	0	A		-	-	-	-	-	-	-	-	Target	
bbo						BITNUM	Source	-	-	-	-	-	1	1	1	0	0	1	0	1	0	A		-	-	-	-	-	-	-	-	Target	
bcnd						Cond	Source	-	-	-	-	-	1	1	1	0	0	1	1	0	0	A		-	-	-	-	-	-	-	-	Target	
cmp						Dest	Source2	-	-	-	-	-	1	1	1	0	1	0	0	0	0		-	-	-	-	-	-	-	-	-	Source1	
add						Dest	Source2	-	-	-	-	-	1	1	1	0	1	1	0	0	0	U		-	-	-	-	-	-	-	-	Source1	
sub						Dest	Source2	-	-	-	-	-	1	1	1	0	1	1	0	1	0	U		-	-	-	-	-	-	-	-	Source1	

- Reserved bit (code as 0)
 D Direct external access bit
 E Emulation trap bit
 F Clear present flags
 i Invert endmask

I Long immediate
 M Modify, write modified address back to register
 n Rotate sense for shifting
 S Scale offset by data size
 SZ Size (0 = byte, 1 = halfword, 2 = word, 3 = doubleword)



MP opcode summary (continued)

Table 6. Miscellaneous Instruction Opcodes

			3	3	2	2	2	2	2	2	2	2	1	1	1	1	1	1	1	1	1	1	1	0	0	0	0	0	0	0	0	0	0	0	0	0
			1	0	9	8	7	6	5	4	3	2	1	0	9	8	7	6	5	4	3	2	1	0	9	8	7	6	5	4	3	2	1	0		
vadd	Mem Src/Dst	Source2/Dst	1	1	1	1	0	-	0	0	0	0	l	-	m	P	-	d	m	s																Source1
vsub	Mem Src/Dst	Source2/Dst	1	1	1	1	0	-	0	0	1	l	-	m	P	-	d	m	s																	Source1
vmpy	Mem Src/Dst	Source2/Dst	1	1	1	1	0	-	0	1	0	l	-	m	P	-	d	m	s																	Source1
vmsub	Mem Src/Dst	Dest	1	1	1	1	0	a	0	1	1	l	a	m	P	Z	-	m	-																Source1	
vrnd(FP)	Mem Src/Dst	Dest	1	1	1	1	0	a	1	0	0	l	a	m	P		PD		m	s															Source1	
vrnd(Int)	Mem Src/Dst	Dest	1	1	1	1	0	-	1	0	1	l	-	m	P	-	d	m	s																	Source1
vmac	Mem Src/Dst	Source2	1	1	1	1	0	a	1	1	0	l	a	m	P	Z	-	m	-																	Source1
vmac	Mem Src/Dst	Source2	1	1	1	1	0	a	1	1	1	l	a	m	P	Z	-	m	-																	Source1
fadd	Dest	Source2	1	1	1	1	1	0	0	0	0	l	-		PD	P2		P1																		Source1
fsub	Dest	Source2	1	1	1	1	1	0	0	0	1	l	-		PD	P2		P1																		Source1
fmpy	Dest	Source2	1	1	1	1	1	0	0	1	0	l	-		PD	P2		P1																		Source1
fdiv	Dest	Source2	1	1	1	1	1	0	0	1	1	l	-		PD	P2		P1																		Source1
frndx	Dest	- - - - -	1	1	1	1	1	0	1	0	0	l	-		PD	RM		P1																		Source1
fcmp	Dest	Source2	1	1	1	1	1	0	1	0	1	l	-			P2		P1																		Source1
fsqrt	Dest	- - - - -	1	1	1	1	1	0	1	1	1	l	-		PD	- -		P1																		Source1
lmo	Dest	Source	1	1	1	1	1	1	0	0	0	-	-	-	-	-	-	-	-	-	-	-	-	-	-	-	-	-	-	-	-	-	-	-	-	-
rmo	Dest	Source	1	1	1	1	1	1	0	0	1	-	-	-	-	-	-	-	-	-	-	-	-	-	-	-	-	-	-	-	-	-	-	-	-	-
estop	- - - - -	- - - - -	1	1	1	1	1	1	1	1	0	-	-	-	-	-	-	-	-	-	-	-	-	-	-	-	-	-	-	-	-	-	-	-	-	-
illopF	- - - - -	- - - - -	1	1	1	1	1	1	1	1	1	C	-	-	-	-	-	-	-	-	-	-	-	-	-	-	-	-	-	-	-	-	-	-	-	-

- Reserved bit (code as 0)
- a Floating-point accumulator select
- C Constant operands rather than register
- d Destination precision for vector (0 = sp, 1 = dp)
- l Long immediate 32-bit data
- m Parallel memory operation specifier
- Mem Src/Dst Vector store or load source/dst register
- Dest Destination register
- P Destination precision for parallel load/store (0 = single, 1 = double)
- P1 Precision of source1 operand
- P2 Precision of source2 operand
- PD Precision of destination result
- RM Rounding Mode (0 = N, 1 = Z, 2 = P, 3 = M)
- S Scale offset by data size
- Z Use 0 rather than accumulator



SMJ320C80 DIGITAL SIGNAL PROCESSOR

SGUS025B - AUGUST 1998 - REVISED JUNE 2002

MP opcode summary (continued)

Table 7. Summary of MP Opcodes

INSTRUCTION	DESCRIPTION	INSTRUCTION	DESCRIPTION
add	Signed integer add	or.ff	Bitwise OR with 1s complement
and.tt	Bitwise AND	or.ft	Bitwise OR with 1s complement
and.ff	Bitwise AND with 1s complement	or.tf	Bitwise OR with 1s complement
and.ft	Bitwise AND with 1s complement	rdcr	Read control register
and.tf	Bitwise AND with 1s complement	rmo	Rightmost one
bbo	Branch bit one	shift.dz	Shift, disable mask, zero extend
bbz	Branch bit zero	shift.dm	Shift, disable mask, merge
bcnd	Branch conditional	shift.ds	Shift, disable mask, sign extend
br	Branch always	shift.ez	Shift, enable mask, zero extend
brcr	Branch control register	shift.em	Shift, enable mask, merge
bsr	Branch and save return	shift.es	Shift, enable mask, sign extend
cmnd	Send command	shift.iz	Shift, invert mask, zero extend
cmp	Integer compare	shift.im	Shift, invert mask, merge
dcache	Flush data cache sub-block	st	Store register into memory
estop	Emulation stop	sub	Signed integer subtract
fadd	Floating-point add	swcr	Swap control register
fcmp	Floating-point compare	trap	Trap
fdiv	Floating-point divide	vadd	Vector floating-point add
fmpy	Floating-point multiply	vmac	Vector floating-point multiply and add to accumulator
frndx	Floating-point convert/round	vmpy	Vector floating-point multiply
fsqrt	Floating-point square root	vmsc	Vector floating-point multiply and subtract from accumulator
fsub	Floating-point subtract	vmsub	Vector floating-point subtract accumulator from source
illop	Illegal operation	vrnd(FP)	Vector round with floating-point input
jsr	Jump and save return	vrnd(Int)	Vector round with integer input
ld	Load signed into register	vsub	Vector floating-point subtract
ld.u	Load unsigned into register	xnor	Bitwise exclusive NOR
lmo	Leftmost one	xor	Bitwise exclusive OR
or.tt	Bitwise OR		



PP architecture

The parallel processor (PP) is a 32-bit integer DSP optimized for imaging and graphics applications. Each PP can execute in parallel: a multiply, ALU operation, and two memory accesses within a single instruction. This internal parallelism allows a single PP to achieve over 500 million operations per second for certain algorithms. The PP has a three-input ALU that supports all 256 three input Boolean combinations and many combinations of arithmetic and Boolean functions. Data-merging and bit-to-byte, bit-to-word, and bit-to-halfword translations are supported by hardware in the input data path to the ALU. Typical tasks performed by a PP include:

- Pixel-intensive processing
 - Motion estimation
 - Convolution
 - PixBLTs
 - Warp
 - Histogram
 - Mean square error
- Domain transforms
 - Discrete Cosine Transform (DCT)
 - Fast Fourier Transform (FFT)
 - Hough
- Core graphics functions
 - Line
 - Circle
 - Shaded fills
 - Fonts
- Image analysis
 - Segmentation
 - Feature extraction
- Bit-stream encoding/decoding
 - Data merging
 - Table look-ups

SMJ320C80

DIGITAL SIGNAL PROCESSOR

SGUS025B - AUGUST 1998 - REVISED JUNE 2002

PP functional block diagram

Figure 22 shows a block diagram of a parallel processor. Key features of the PP include:

- 64-bit instruction word (supports multiple parallel operations)
- Three-stage pipeline for fast instruction cycle
- Numerous registers
 - 8 data, 10 address, 6 index registers
 - 20 other user-visible registers
- Data Unit
 - 16 x 16 integer multiplier (optional dual 8 x 8)
 - Splittable 3-input ALU
 - 32-bit barrel rotator
 - Mask generator
 - Multiple status flag expander for translations to/from 1 bit-per-pixel space.
 - Conditional assignment of data unit results
 - Conditional source selection
 - Special processing hardware
 - Leftmost one/rightmost one
 - Leftmost bit change/rightmost bit change
- Memory addressing
 - Two address units (global and local) provide up to two 32-bit accesses in parallel with data unit operation.
 - 12 addressing modes (immediate and indexed)
 - Byte, halfword, and word addressability
 - Scaled indexed addressing
 - Conditional assignment for loads
 - Conditional source selection for stores
- Program flow
 - Three hardware loop controllers
 - Zero overhead looping/branching
 - Nested loops
 - Multiple loop endpoints
 - Instruction cache management
 - PC mapped to register file
 - Interrupts for messages and context switching
- Algebraic assembly language



PP functional block diagram (continued)

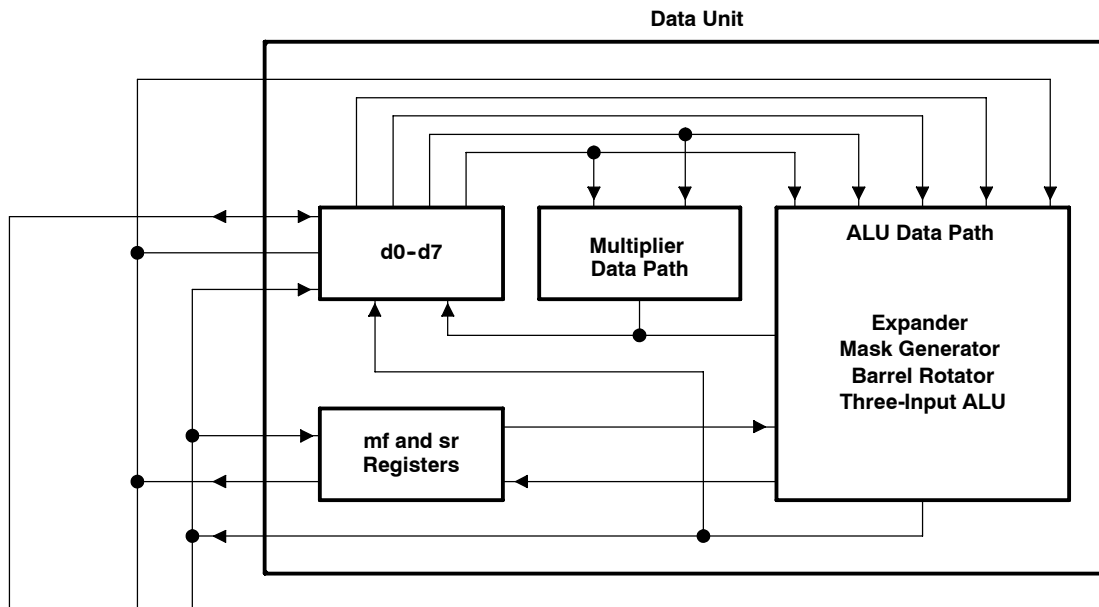

Figure 22. PP Block Diagram

SMJ320C80 DIGITAL SIGNAL PROCESSOR

SGUS025B - AUGUST 1998 - REVISED JUNE 2002

PP registers

The PP contains many general-purpose registers, status registers, and configuration registers. All PP registers are 32-bit registers. Figure 23 shows the accessible registers of the PP blocks.

Data-Unit Registers

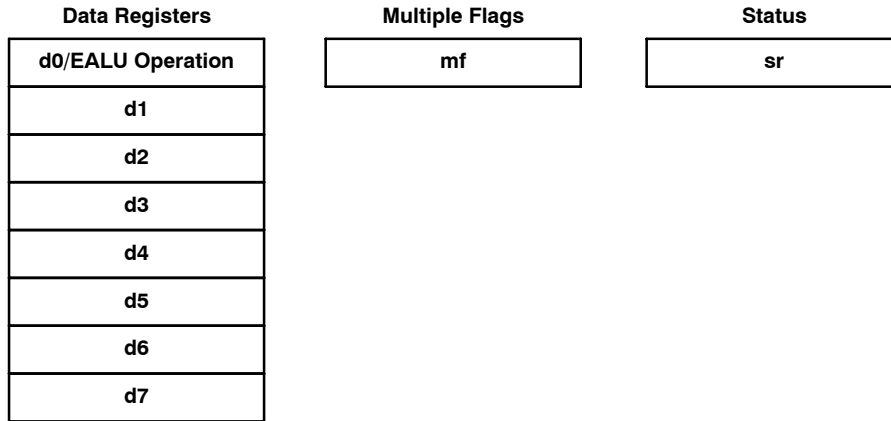

Address-Unit Registers

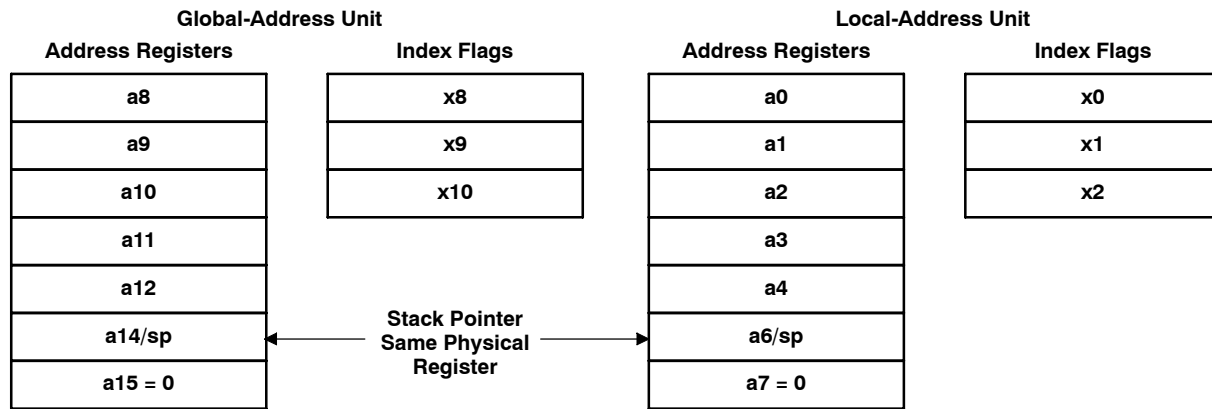

Program Flow Control (PFC) Unit Registers

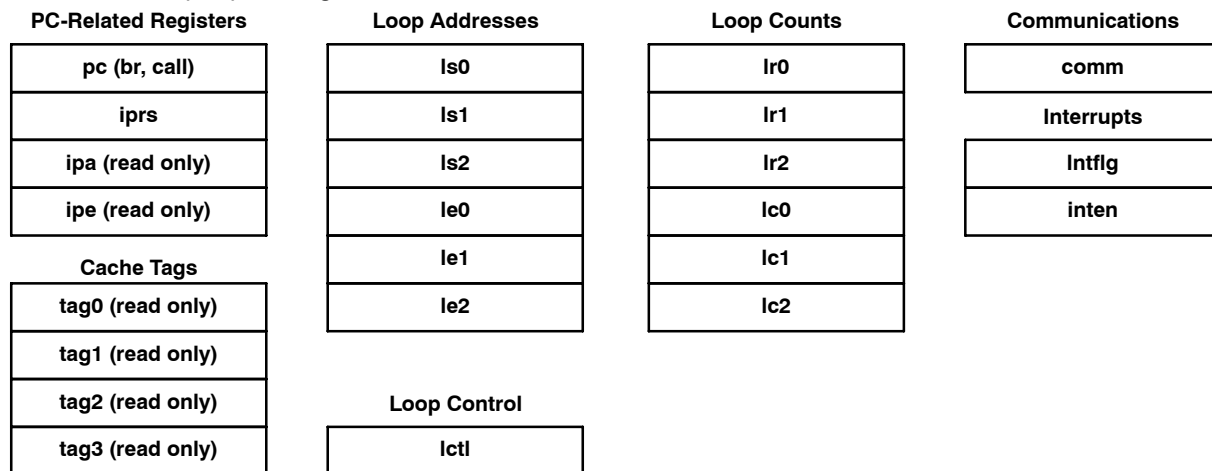

Figure 23. PP Registers

PP data-unit registers

The data unit contains eight 32-bit general-purpose data registers (d0-d7) referred to as the D registers. The d0 register also acts as the control register for extended ALU (EALU) operations.

d0 register

Figure 24 shows the format when d0 is used as the EALU control register.

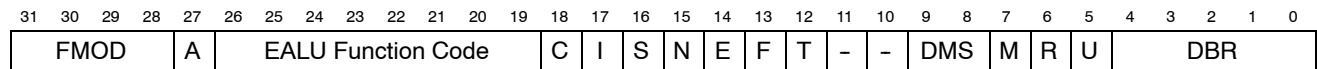

- | | |
|--|---|
| <p>FMOD Function modifiers</p> <p>A Arithmetic enable</p> <p>C EALU carry-in</p> <p>I Invert-carry-in</p> <p>S Sign extend</p> <p>N Nonmultiple mask</p> | <p>E Explicit multiple carry-in</p> <p>F Expanded multiple flags</p> <p>DMS Default multiply shift amount</p> <p>M Split multiply</p> <p>R Rounded multiply</p> <p>DBR Default barrel rotate amount</p> |
|--|---|

Figure 24. d0 Format for EALU Operations

multiple flags (mf) register

The mf register records status information from each split ALU segment for multiple arithmetic operations. The mf register can be expanded to generate a mask for the ALU. Figure 25 shows the mf register format.

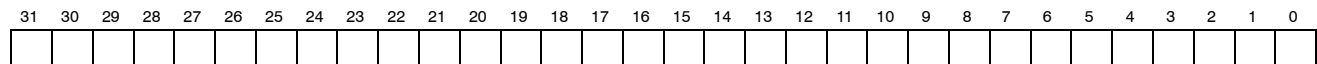
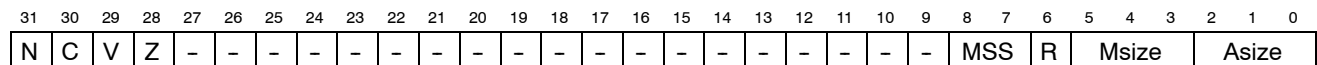

Figure 25. mf Register Format

status register (sr)

The sr contains status and control bits for the PP ALU. See Figure 26.



- | | |
|---|--|
| <p>N Negative status bit</p> <p>C Carry status bit</p> <p>V Overflow status bit</p> <p>Z Zero status bit</p> <p>R Rotation bit</p> | <p>MSS mf status selection</p> <p style="padding-left: 20px;">00 - set by zero 10 - set by extended result</p> <p style="padding-left: 20px;">01 - set by sign 11 - reserved</p> <p>Msize Expander data size</p> <p>Asize Split ALU data size</p> |
|---|--|

Figure 26. sr Format

PP address-unit registers

address registers

The address unit contains ten 32-bit address registers which contain the base address for address computations or which can be used for general-purpose data. The registers a0 - a4 are used for local-address computations and registers a8-a12 are used for global-address computations.

SMJ320C80 DIGITAL SIGNAL PROCESSOR

SGUS025B - AUGUST 1998 - REVISED JUNE 2002

index registers

The six 32-bit index registers contain index values for use with the address registers in address computations or they can be used for general-purpose data. Registers x0-x3 are used by the local-address unit and registers x8-x9 are used by the global-address unit.

stack pointer (sp)

The sp contains the address of the top of the PP's system stack. The stack pointer is addressed as a6 by the local-address unit and as a14 by the global-address unit. Figure 27 shows the sp register format.

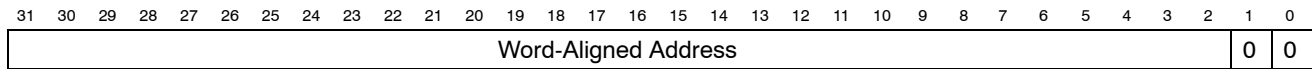

Figure 27. sp Register Format

zero registers

The zero registers are read-as-zero address registers for the local address unit (a7) and global-address unit (a15). Writes to the registers are ignored and can be specified when operational results are to be discarded.

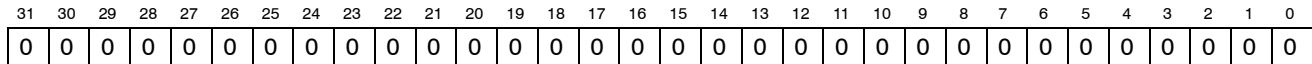

Figure 28. Zero Registers

PP program flow control (PFC) unit registers

loop registers

The loop registers control three levels of zero-overhead loops. The 32-bit loop-start registers (ls0 - ls2) and loop-end registers (le0 - le2) contain the starting and ending addresses for the loops. The loop-counter registers (lc0 - lc2) contain the number of repetitions remaining in their associated loops. The lr0 - lr2 registers are loop reload registers used to support nested loops. The format for the loop-control (lctl) register is shown in Figure 29. There are also six special write-only mappings of the loop-reload registers. The lrs0 - lrs2 codes are used for fast initialization of lsn, lrn, and lcn registers for multi-instruction loops while the lrse0 - lrse2 codes are used for single instruction-loop fast initialization.

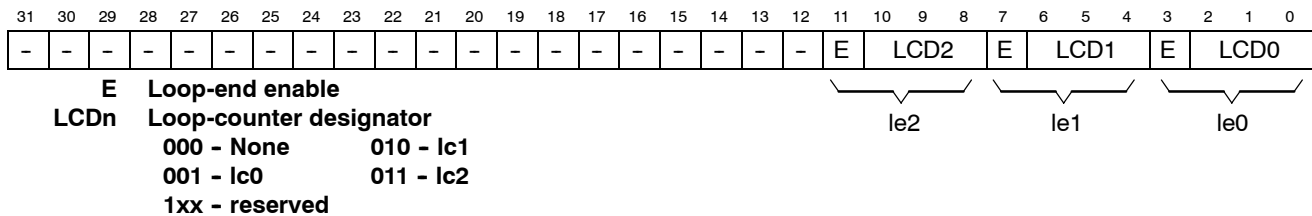

Figure 29. lctl Register

pipeline registers

The PFC unit contains a pointer to each stage of the PP pipeline. The pc contains the program counter which points to the instruction being fetched. The ipa points to the instruction in the address stage of the pipeline and the ipe points to the instruction in the execute stage of the pipeline. The instruction pointer return-from-subroutine (iprs) register contains the return address for a subroutine call.



pipeline registers (continued)

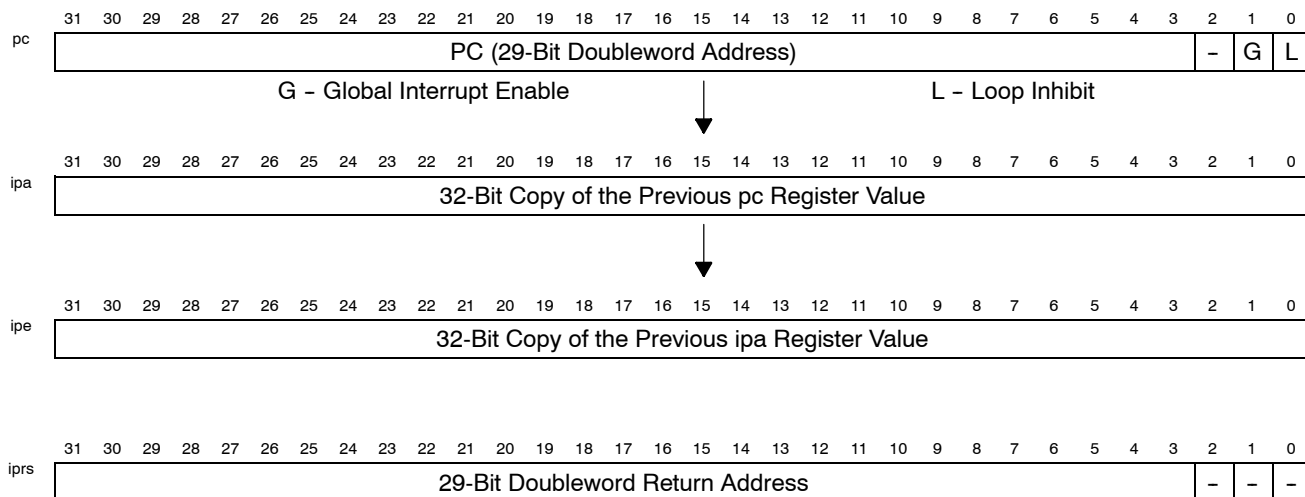
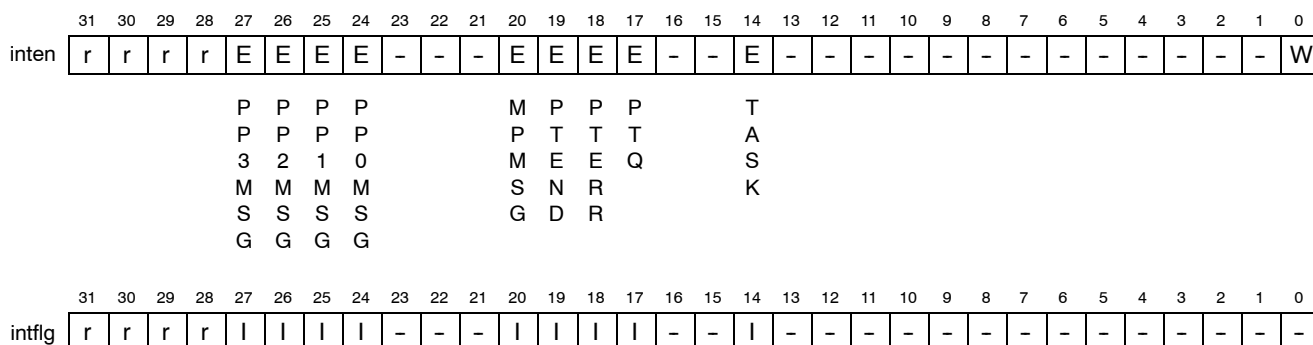

Figure 30. Pipeline Registers

interrupt registers

The interrupt-enable (**inten**) register allows individual interrupts to be enabled and configures the interrupt flag (**intflg**) register operation. The **intflg** register contains the interrupt flag bits. Interrupt priority increases moving from left to right on **intflg**.



- | | |
|-------------------------------------|---------------------------------------|
| r Reserved (write as 0) | MPMSG MP message interrupt |
| E Enable interrupt | PTEND Packet transfer complete |
| W Write mode | PTERR Packet-transfer error |
| 0 - writing 1 clears intflg | PTQ Packet transfer queued |
| 1 - writing 1 sets intflg | TASK MP task interrupt |
| PPnMSG PPn message interrupt | |

Figure 31. PP-Interrupt Registers

SMJ320C80 DIGITAL SIGNAL PROCESSOR

SGUS025B - AUGUST 1998 - REVISED JUNE 2002

communication (comm) register

The comm register contains the packet-transfer handshake bits and PP indicator bits.

31	30	29	28	27	26	25	24	23	22	21	20	19	18	17	16	15	14	13	12	11	10	9	8	7	6	5	4	3	2	1	0
H	S	Q	P	-	-	-	-	-	-	-	-	-	-	-	-	-	-	-	-	-	-	-	-	-	-	-	-	-	-	-	PP#

- | | | | |
|----------|--------------------------------|------------|------------------------|
| H | High-priority packet transfer | PP# | PP Number (read only) |
| S | Packet-transfer suspend | 000 | - PP0 010 - PP2 |
| Q | Packet transfer queued | 001 | - PP1 011 - PP3 |
| P | Submit packet transfer request | 1xx | - Not implemented |

Figure 32. comm Register

cache-tag registers

The tag0 - tag3 registers contain the tag address and sub-block present bits for each cache block.

31	30	29	28	27	26	25	24	23	22	21	20	19	18	17	16	15	14	13	12	11	10	9	8	7	6	5	4	3	2	1	0
23-Bit Tag Address																							P	P	P	P	-	-	-	LRU	

- | | | | |
|------------|--------------------------------------|--------------------|-------------------------------------|
| P | Present bit | Sub-Block # | 3 2 1 0 |
| LRU | Least-recently-used code | | |
| | 00 - Most-recently-used (MRU) | | |
| | 10 - next LRU | | |
| | 01 - next MRU (NMRU) | | |
| | 11 - LRU | | |

Figure 33. Cache-Tag Registers

PP cache architecture

Each PP has its own 2K-byte instruction cache. Each cache is divided into four blocks and each block is divided into four sub-blocks containing 16 64-bit instructions each. Cache misses cause one sub-block to be loaded into cache. Figure 34 shows the cache architecture for one of the four sets in each cache. Figure 35 shows how addresses map into the cache using the cache tags and address bits.

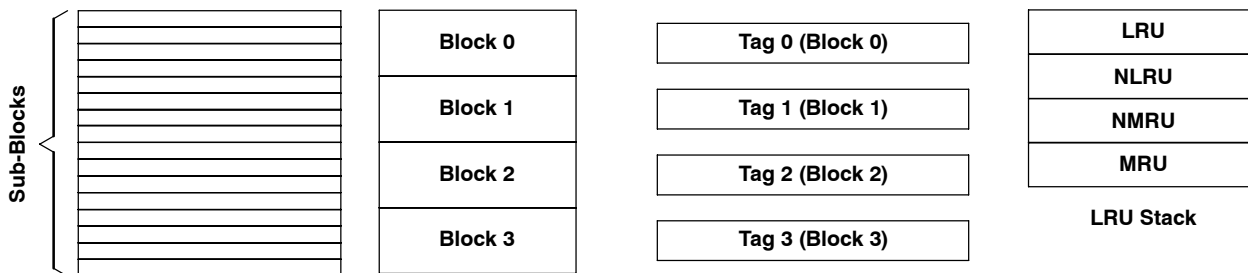

Figure 34. PP Cache Architecture

31	30	29	28	27	26	25	24	23	22	21	20	19	18	17	16	15	14	13	12	11	10	9	8	7	6	5	4	3	2	1	0
23-Bit Tag Value																							sub	instruction	ignored						

sub - sub-block

Figure 35. PP Register Cache-Address Mapping



PP parameter RAM

The parameter RAM is a 2K-byte, on-chip RAM which contains PP-interrupt vectors, PP-requested TC task buffers, and a general-purpose area. The parameter RAM does not use the cache memory. Figure 35 shows the parameter RAM address map.

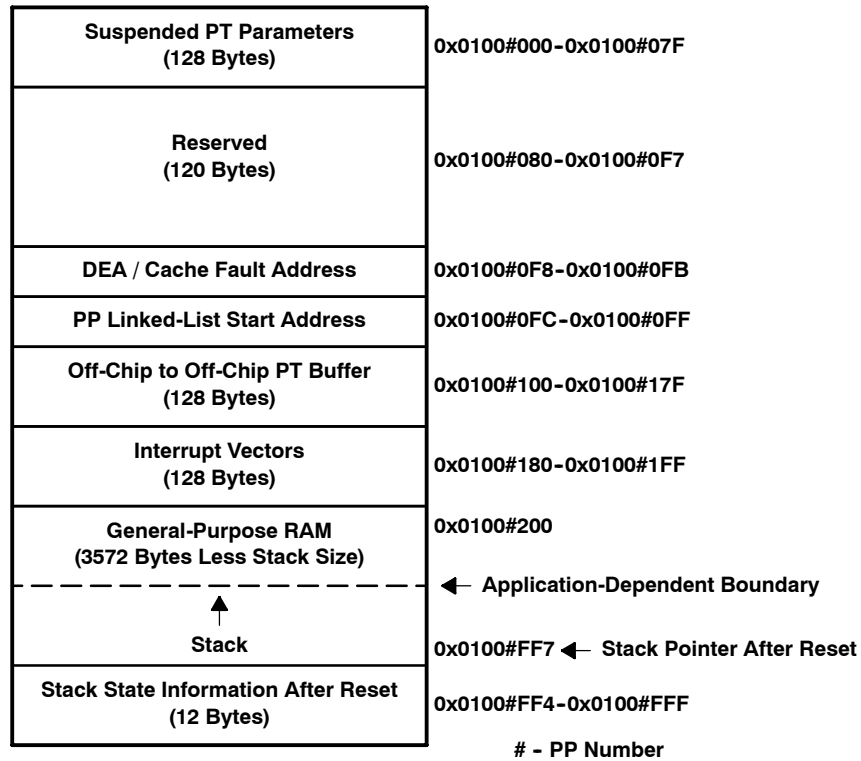

Figure 36. PP Parameter RAM Address Map

PP-interrupt vectors

The PP interrupts and their vector addresses are shown in Table 8.

Table 8. PP-Interrupt Vectors

NAME	VECTOR ADDRESS	INTERRUPT
TASK	0x0100#1B8	Task Interrupt
PTQ	0x0100#1C4	Packet Transfer Queued
PTERR	0x0100#1C8	Packet-Transfer Error
PTEND	0x0100#1CC	Packet Transfer End
MPMSG	0x0100#1D0	MP Message
PP0MSG	0x0100#1E0	PP0 Message
PP1MSG	0x0101#1E4	PP1 Message

SMJ320C80 DIGITAL SIGNAL PROCESSOR

SGUS025B - AUGUST 1998 - REVISED JUNE 2002

PP data-unit architecture

The data unit has independent data paths for the ALU and the multiplier, each with its own set of hardware functions. The multiplier data path includes a 16×16 multiplier, a halfword swapper, and rounding hardware. The ALU data path includes a 32-bit three-input ALU, a barrel rotator, mask generator, multiple flag (mf) expander, left/rightmost one and left/rightmost bit-change logic, and several multiplexers. Figure 37 shows the data-unit block diagram.

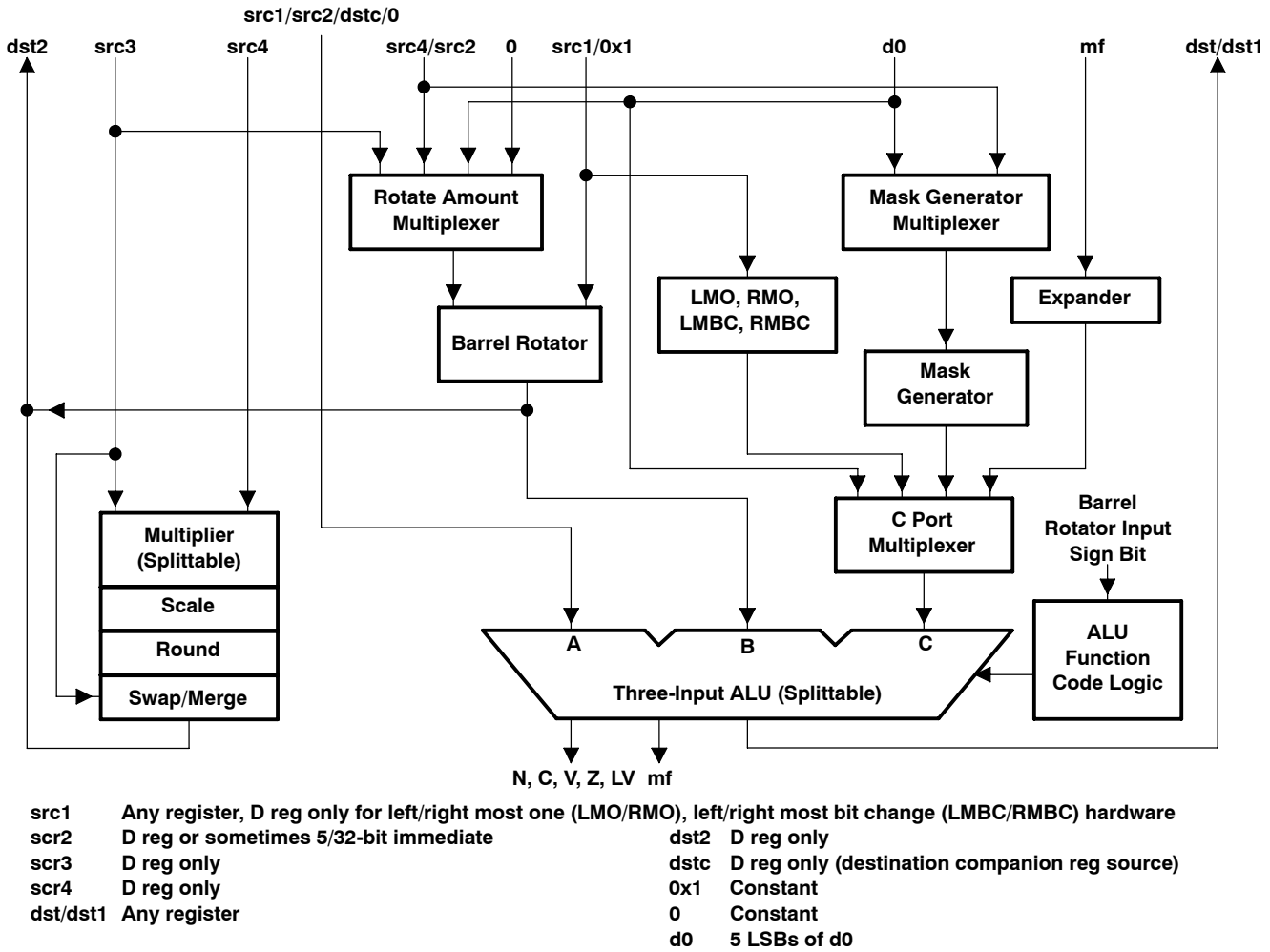

Figure 37. Data-Unit Block Diagram

PP data-unit architecture (continued)

The PP's ALU can be split into one 32-bit ALU, two 16-bit ALUs, or four 8-bit ALUs. Figure 38 shows the multiple arithmetic data flow for the case of a four 8-bit split of the ALU (called multiple-byte arithmetic). The ALU operates as independent parallel ALUs where each ALU receives the same function code.

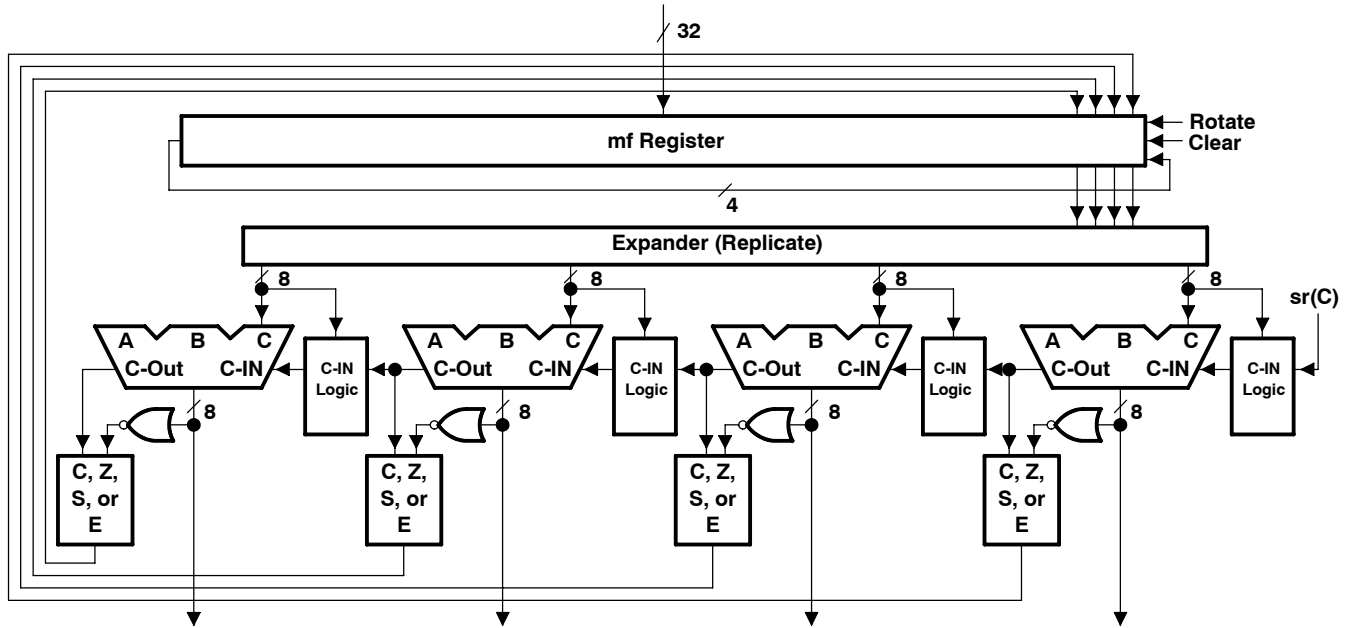

Figure 38. Multiple-Byte Arithmetic Data Flow

PP multiplier

The PP's hardware multiplier can perform one 16x16 multiply with a 32-bit result or two 8x8 multiplies with two 16-bit results in a single cycle. A 16x16 multiply can use signed or unsigned operands as shown in Figure 39.

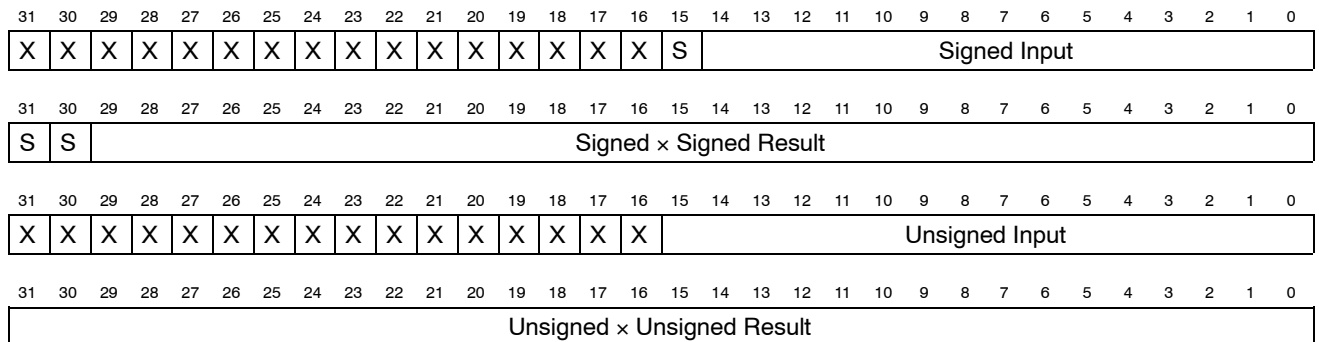

Figure 39. 16 x 16 Multiplier Data Formats

SMJ320C80 DIGITAL SIGNAL PROCESSOR

SGUS025B - AUGUST 1998 - REVISED JUNE 2002

PP multiplier (continued)

When performing two simultaneous 8x8 split multiplies, the first input word contains unsigned byte operands and the second input word contains signed or unsigned byte operands. These formats are shown in Figure 40 and Figure 41.

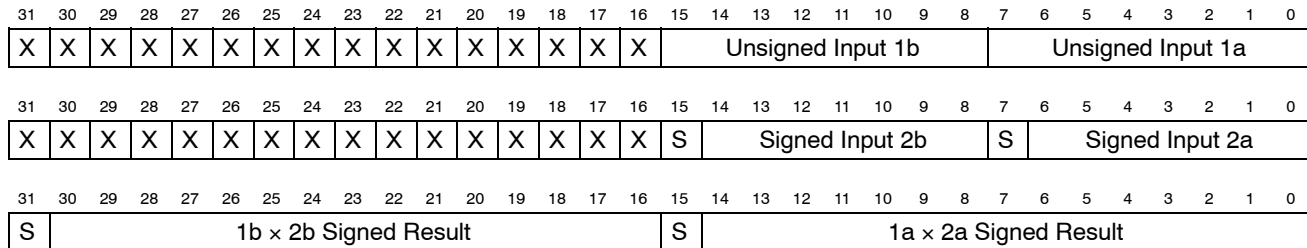

Figure 40. Signed Split Multiply Data Formats

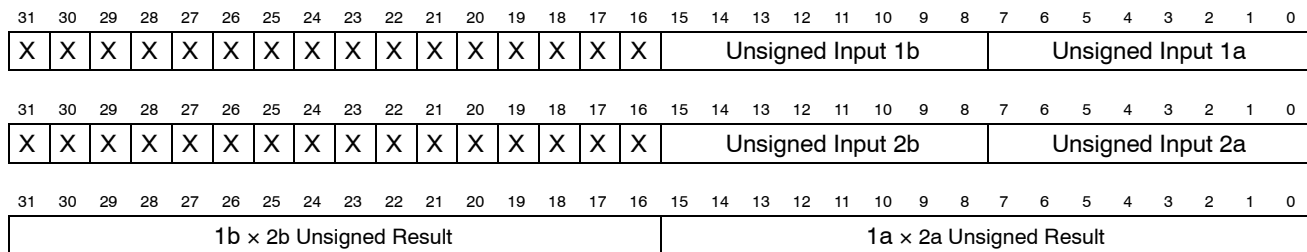

Figure 41. Unsigned Split Multiply Data Formats

PP program-flow-control unit architecture

The program-flow-control (pfc) unit performs instruction fetching and decoding, loop control, and handshaking with the transfer controller. The pfc unit architecture is shown in Figure 43.

The PP has a three-stage fetch, address, execute (FAE) pipeline as shown in Figure 42. The pc, ipa, and ipe registers point to the address of the instruction in each stage of the pipeline. On each cycle in which the pipeline advances, ipa is copied into ipe, pc is copied into ipa, and the pc is incremented by one instruction (8 bytes).

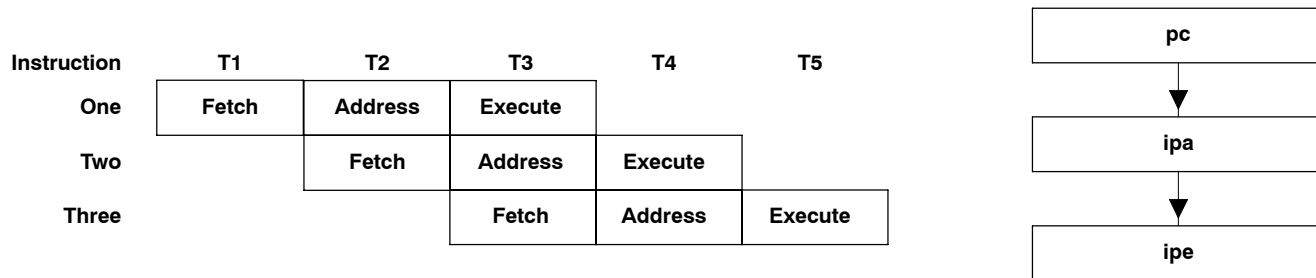

Figure 42. FAE-Instruction Pipeline

PP program-flow-control unit architecture (continued)

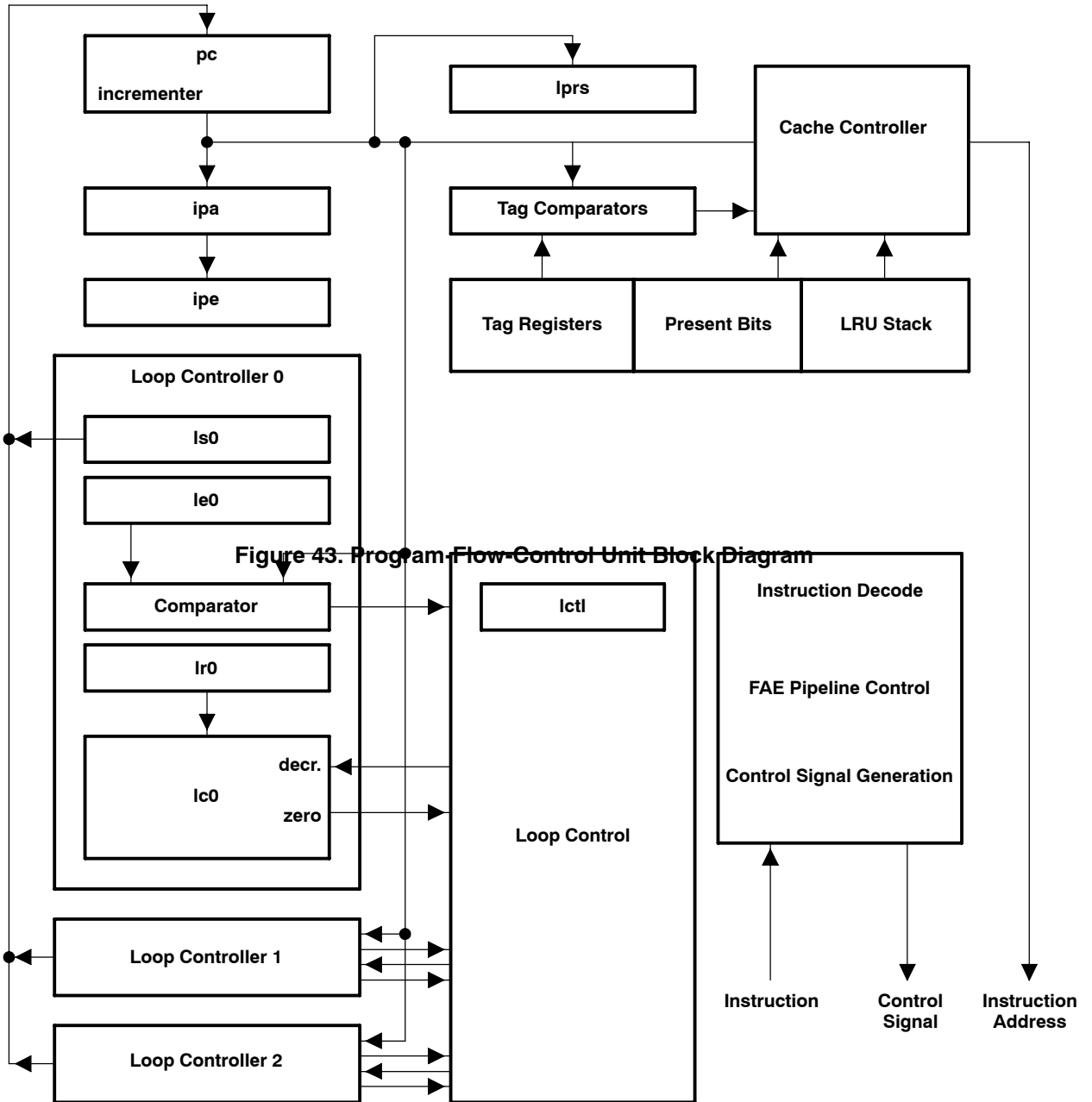

Figure 43. Program Flow-Control Unit Block Diagram

PP address-unit architecture

The PP has both a local- and global-address unit which operate independently of each other. The address units support twelve different addressing modes. In place of performing a memory access, either or both of the address units can perform an address computation that is written directly to a PP register instead of being used for a memory access. This address unit arithmetic provides additional arithmetic operation to supplement the data unit during compute-intensive algorithms.

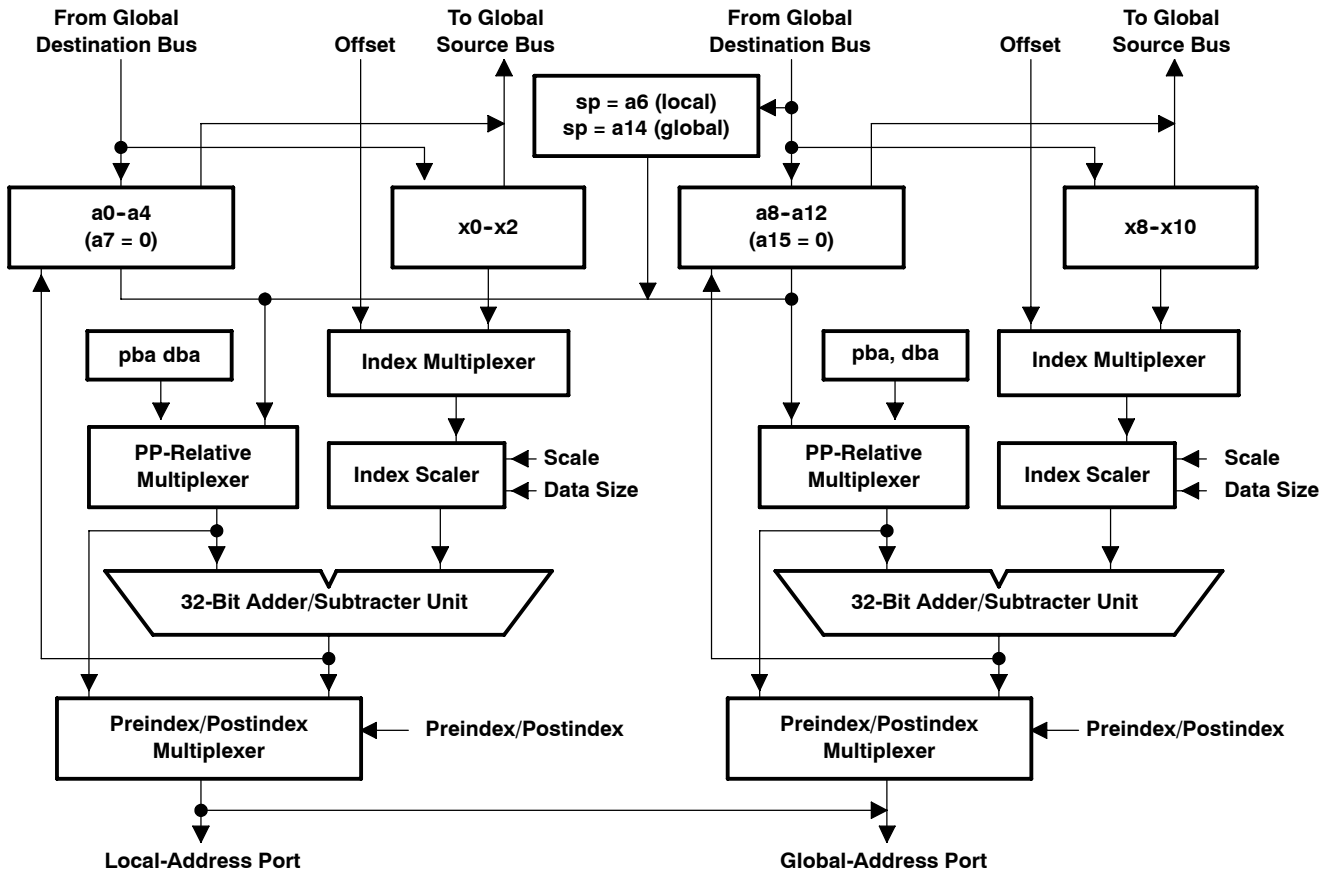

Figure 44. Address-Unit Architecture

PP instruction set

PP instructions are represented by algebraic expressions for the operations performed in parallel by the multiplier, ALU, global-address unit, and local-address unit. The expressions use the || symbol to indicate operations that are to be performed in parallel. The PP ALU operator syntax is shown in Table 9. The data unit operations (multiplier and ALU) are summarized in Table 10 and the parallel transfers (global and local) are summarized in Table 11.

Table 9. PP Operators by Precedence

OPERATOR	FUNCTION
src1 [n] src1-1	Select odd (n=true) or even (n=false) register of D register pair based on negative condition code
()	Subexpression delimiters
@mf	Expander operator
%	Mask generator
%%	Nonmultiple mask generator (EALU only)
%!	Modified mask generator (0xFFFFFFFF output for 0 input)
%%!	Nonmultiple shift right mask generator (EALU only)
\\	Rotate left
<<	Shift left (pseudo-op for rotate and mask)
>>u	Unsigned shift right
>> or >>s	Signed shift right
&	Bitwise AND
^	Bitwise XOR
	Bitwise OR
+	Addition
-	Subtraction
=[cond]	Conditional assignment
=[cond.pro]	Conditional assignment with status protection
=	Equate

PP instruction set (continued)

Table 10. Summary of Data-Unit Operations

Operation	Base set ALUs
Description	Perform an ALU operation specifying ALU function, 2 src and 1 dest operand, and operand routing. ALU function is one of 256 three-input Boolean operations or one of 16 arithmetic operations combined with one of 16 function modifiers.
Syntax	dst = [fmod] [[[cond [.pro]]]] ALU_EXPRESSION
Examples	d6 = (d6 ^ d4) & d2 d3 = [nn.nv] d1 -1
Operation	EALU ROTATE
Description	Perform an extended ALU (EALU) operation (specified in d0) with one of two data routings to the ALU and optionally write the barrel rotator output to a second dest register. ALU function is one of 256 Boolean or 256 arithmetic.
Syntax	dst1 = [[[cond [.pro]]]] ealu (src2, [dst2 =] [[[cond]] src1 [[[n]] src1-1] \\ src3, [%] src4) dst1 = [fmod] [[[cond [.pro]]]] ealu (label:EALU_EXPRESSION [dst2 = [[cond]] src1 [[[[n]] src1-1] \\ src3])
Examples	d7 = [nn] ealu(d2, d6 = [nn] d3\\d1, %d4) d3 = mzc ealu(mylabel: d4 + (d5\\d6 & %d7) d1 = d5\\d6)
Operation	MPY ADD
Description	Perform a 16x16 multiply with optional parallel add or subtract. Condition code applies to both multiply and add.
Syntax	dst2 = [sign] [[[cond]]] src3 * src4 [dst = [[[cond[.pro]]]] src2 + src1 [[[[n]] src1 -1]] dst2 = [sign] [[[cond]]] src3 * src4 [dst = [[[cond[.pro]]]] src2 - src1 [[[[n]] src1 -1]]
Example	d7 = u d6 * d5 d5 = d4 - d1
Operation	MPY SADD
Description	Perform a 16x16 multiply with a parallel right-shift and add or subtract. Condition code applies to multiply, shift, and add.
Syntax	dst2 = [sign] [[[cond]]] src3 * src4 dst = [[[cond [.pro]]]] src2 + src1 [[[[n]] src1 -1]] >> -d0 dst2 = [sign] [[[cond]]] src3 * src4 dst = [[[cond [.pro]]]] src2 - src1 [[[[n]] src1 -1]] >> -d0
Examples	d7 = u d6 * d5 d5 = d4 - d1 >> -d0
Operation	MPY EALU
Description	Perform a multiply and an optional parallel EALU. Multiply can use rounding, scaling, or splitting features.
Syntax	Generic Form: dst2 = [sign] [[[cond]]] src3 * src4 dst = [[[cond [.pro]]]] ealu[f] (src2, src1 [[[[n]] src1 -1]] \\ d0, %d0) dst2 = [sign] [[[cond]]] src3 * src4 ealu() Explicit Form: dst2 = [sign] [opt] [[[cond]]] src3 * src4 [<<dms] dst1 = [fmod] [[[cond [.pro]]]] ealu (label: EALU_EXPRESSION) dst2 = [sign] [opt] [[[cond]]] src3 * src4 [<<dms] ealu (label)
Examples	d7 = [p] d5 * d3 d2 = [p] ealu(d1, d6\\d0, %d0) ; generic form d2 = m d4 * d7 d3 = ealu (mylabel: d3 + d2 >> 9) ; explicit form
Operation	divi
Description	Perform one iteration of unsigned divide algorithm. Generates one quotient bit per execution using iterative subtraction.
Syntax	dst1 = [[[cond [.pro]]]] divi (src2, dst2 = [[cond]] src1 [[[[n]] src1 -1]])
Examples	d3 = divi (d1, d2 = d2) d3 = divi (d1, d2 = d3[n]d2)
Misc. Operations	dint; eint; nop
Description	Globally disable interrupts; globally enable interrupts; do nothing in the data unit
Syntax	dint eint nop

Legend:

[]	Optional parameter extension	cond	Condition code
[[]]	Square brackets ([]) must be used	fmod	Function modifier
pro	Protect status bits	dms	Default multiply shift amount
f	Use 1s complement of d0	sign	u = unsigned, s = signed

PP instruction set (continued)

Table 11. Summary of Parallel Transfers

Operation	Load
Description	Transfer from memory into PP register
Syntax	dst = [sign] [size] [[[cond]]] * addrxp dst = [sign] [size] [[[cond]]] * an.element
Examples	d3 = uh[n] * (a9++=[2]) d1 = * a2.sMY_ELEMENT
Operation	Store
Description	Transfer from PP register into memory
Syntax	* addrxp = [size] src [[[n]] src-1] * an.element = [size] src [[[n]] src-1]
Examples	*--a2 = d3 *a9.sMY_ELEMENT = a3
Operation	Address unit arithmetic
Description	Compute address and store in PP register
Syntax	dst = [size] [[[cond]]] & * addrxp dst = [size] [[[cond]]] & * an.element
Examples	d2 = &(a3 + x0) a1 = &*a9.sMY_ELEMENT
Operation	Move
Description	Transfer from PP register to PP register
Syntax	dst = [g] [[[cond]]] src
Examples	x2 = mf d1 = g d3
Operation	Field extract move
Description	Transfer from PP register to PP register extracting and right-aligning one byte or halfword
Syntax	dst = [sign] [size item]
Example	d3 = ub2 d1
Operation	Field replicate move
Description	Transfer from PP register to PP register replicating the least significant byte or least significant halfword to 32 bits
Syntax	dst = r [size] [[cond]] src
Example	d7 = rh d3

Legend:

[]	Optional parameter extension	cond	Condition code
[[]]	Square brackets ([]) must be used	sign	u = unsigned, s = signed
g	Use global unit	size	b = byte, h = halfword, w = word (default)
item	0 = byte0/halfword0, 1 = byte1/halfword1, 2 = byte2, 3 = byte3		

SMJ320C80 DIGITAL SIGNAL PROCESSOR

SGUS025B - AUGUST 1998 - REVISED JUNE 2002

PP opcode formats

A PP instruction uses a 64-bit opcode. The opcode is divided essentially into a data unit portion and a parallel transfer portion. There are five data unit opcode formats comprising bits 38–63 of the opcode. Bits 0–38 of the opcode specify one of 10 parallel transfer formats. An alphabetical list of the mnemonics used in Figure 45 for the data unit and parallel transfer portions of the opcode are shown in Table 12 and Table 13, respectively.

Data Unit Formats

6 6 6 6 5 5 5 5 5 5 5 5 5 4 4 4 4 4 4 4 4 4 4 3 3 3 3 3 3 3 3 3 2
3 2 1 0 9 8 7 6 5 4 3 2 1 0 9 8 7 6 5 4 3 2 1 0 9 8 7 6 5 4 3 2 1 0 9 3 2 1 0

0	1	1	oper	src3	dst2	dst1	src1	src4	src2	Parallel Transfers				}}					
1	class	A	ALU Operation			dst	src1	0	imm. src2	Parallel Transfers				}}					
1	class	A	ALU Operation			dst	src1	1 0	-	src2	Parallel Transfers				}}				
1	class	A	ALU Operation			dst	src1	1 1	dstbank	s1bnk	cond	32-Bit Immediate			}}				
1	0	0	0	1	-	0	-	0	-	0	-	-	-	0	Operation	Parallel Transfers			}}
0	0	Reserved													}}				
0	1	0	Reserved													}}			

- A. Six-Operand (MPYIIADD, etc.)
- B. Base Set ALU (5-Bit Immediate)
- C. Base Set ALU (Register src2)
- D. Base Set ALU (32-Bit Immediate)
- E. Miscellaneous

Transfer Formats

3 3 3 3 3 3 3 3 3 2 2 2 2 2 2 2 2 2 2 1 1 1 1 1 1 1 1 1 1 1 1 1 1 1 1
8 7 6 5 4 3 2 1 0 9 8 7 6 5 4 3 2 1 0 9 8 7 6 5 4 3 2 1 0 9 8 7 6 5 4 3 2 1 0

Lmode	d	e	size	s	La	Gim/X	L	0bank	L	Gmode	reg	e	size	s	Ga	Lim/X	1. Double Parallel										
Lmode	d	e	size	s	La	0	Lrm	dstbank	L	0	0	0	0	src	srcbank	dst	Lim/X	2. Move II Local									
Lmode	d	e	size	s	La	0	Lrm	dstbank	L	0	0	0	1	src	e	size	D	dst	Lim/X	3. Field Move II Local							
Lmode	reg	e	size	s	La	1	Lrm	bank	L	0	0	Local Long Offset / X					4. Local (Long Offset)										
0	0	Global Long Offset / X						bank	L	Gmode	reg	e	size	s	Ga	0	Grm	5. Global (Long Offset)									
Lmode	d	e	size	s	La	0	Lrm	Adstbank	L	0	0	1	-	-	-	As1bank	-	-	-	6. Non-D DU II Local							
0	0	-	cond	c	r	g	N	C	V	Z	0	-	-	dstbank	-	0	0	0	0	src	srcbank	dst	-	-	-	7. Conditional DU II Conditional Mode	
0	0	-	cond	c	r	g	N	C	V	Z	0	itm	dstbank	-	0	0	0	1	src	e	size	D	dst	-	-	-	8. Conditional DU II Conditional Field Move
0	0	-	cond	c	r	g	N	C	V	Z	Gim/X	bank	L	Gmode	reg	e	size	s	Ga	1	Grm	-	-	-	-	9. Conditional DU II Conditional Global	
0	0	-	cond	c	r	-	N	C	V	Z	0	-	-	Adstbank	-	0	0	1	-	-	-	As1bank	-	-	-	-	10. Conditional Non-D DU

Figure 45. PP Opcode Formats



PP opcode formats (continued)

Table 12. Data Unit Mnemonics

MNEMONIC	FUNCTION
A	A = 1 selects arithmetic operations, A = 0 selects Boolean operations
ALU Operation	For Boolean operation (A = 0), select the eight ALU function signals. For arithmetic operation (A = 1), odd bits specify the ALU function and even bits define the ALU function modifiers.
class	Operation class: determines routing of ALU operands
cond	condition code
dst	D register destination or lower 3 bits of non-D register code
dst1	ALU dest. for MPY ADD, MPY EALU, or EALU ROTATE operation. D register or lower 3 bits of non-D register code
dst2	Multiply dest. for MPY ADD or MPY EALU operation, or rotate dest. for EALU ROTATE operation. D register
dstbank	ALU register bank
imm.src2	5-bit immediate for src2 of ALU operation
32-Bit Immediate	32-bit immediate for src2 of ALU operation
oper	Six-operand data unit operation (MPY ADD, MPY SADD, MPY EALU, EALU ROTATE, divi)
Operation	Miscellaneous operation
src1	ALU source 1 register code (D register unless srcbank or s1bnk is used)
src2	D register used as ALU source 2
src3	D register for multiplier source (MPY ADD or MPY EALU) or rotate amount (EALU ROTATE)
src4	D reg. for ALU C port operand or EALU ROTATE mask generator input or multiplier source 2 for MPY ADD, MPY EALU
s1bnk	Bits 5-3 of src1 register code (bit 6 assumed to be 0)

PP opcode formats (continued)

Table 13. Parallel Transfer Mnemonics

MNEMONIC	FUNCTION
0bank	Bits 5-3 of global transfer source/destination register code (bit 6 assumed to be 0)
Adstbank	Bits 6-3 of ALU destination register code
As1bank	Bits 6-3 of ALU source 1 register code
bank	Bits 6-3 of global (or local) store source or load destination
c	Conditional choice of D register for src1 operand of the ALU
C	Protect status register's carry bit
cond	Condition code
d	D register or lower 3 bits of register code for local transfer source/destination
D	Duplicate least significant data during moves
dst	The three lowest bits of the register code for move or field-move destination
dstbank	Bits 6-3 of move destination register code
e	Sign-extend local (bit 31), sign-extend global (bit 9)
g	Conditional global transfer
Ga	Global address register for load, store, or address unit arithmetic
Gim / X	Global address unit immediate offset or index register
Gmode	Global unit addressing mode
Grm	Global PP-relative addressing mode
itm	Number of items selected for field-extract move
L	L = 1 selects load operation, L = 0 selects store/address unit arithmetic operation
La	Local address register for load, store, or address unit arithmetic
Lim / X	Local address unit immediate offset or index register
Lmode	Local unit addressing mode
Lrm	Local PP-relative addressing mode
N	Protect status register's negative bit
r	Conditional write of ALU result
reg	Register number used with bank or 0bank for global load, store, or address unit arithmetic
s	Enable index scaling. Additional index bit for byte accesses or arithmetic operations (bit 28, local; bit 6, global)
size	Size of data transfer (bits 30-29, local; bits 8-7, global)
src	Three lowest bits of register code for register-register move source or non-field moves. D register source for field move
srcbank	Bits 6-3 of register code for register-register move source
V	Protect status register's overflow bit
Z	Protect status register's zero bit
-	Unused bit (fill with 0)

PP opcode formats (continued)

Table 14 summarizes the supported parallel-transfer formats and indicates whether the transfers are local or global. It also lists the allowed ALU operations and states whether conditions and status protection are supported.

Table 14. Parallel-Transfer Format Summary

FORMAT	ALU OPERANDS		Cond	Status Protection	GLOBAL TRANSFER				LOCAL TRANSFER			
	dst1	src1			Move src → dst	Load/Store/AUA			Load/Store/AUA			
						s/d	Index	Rel	s/d	Index	Rel	Port
Double parallel	D	D	No	No	—	Lower	X/short	No	D	X/short	No	Local
Move Local	D	D	No	No	Any→Any	—	—	—	D	X/short	Yes	Local
Field move Local	D	D	No	No	D→Any	—	—	—	D	X/short	No	Local
Global (long offset)	D	D	No	No	—	Any	X/long	Yes	—	—	—	—
Local (long offset)	D	D	No	No	—	—	—	—	Any	X/long	Yes	Global
Non-D DU Local	Any	Any	No	No	—	—	—	—	D	X/short	Yes	Global
Conditional move	D	D	Yes	Yes	Any→Any	—	—	—	—	—	—	—
Conditional field move	D	D	Yes	Yes	D→Any	—	—	—	—	—	—	—
Conditional global	D	D	Yes	Yes	—	Any	X/short	Yes	—	—	—	—
Conditional non-D DU	Any	Any	Yes	Yes	—	—	—	—	—	—	—	—
32-bit imm. base ALU	Any	Lower	Yes	No	—							

Legend:

- DU Data unit
- AUA Address unit arithmetic
- s/d Source/destination register
- Rel Relative addressing support

SMJ320C80 DIGITAL SIGNAL PROCESSOR

SGUS025B - AUGUST 1998 - REVISED JUNE 2002

PP opcode formats (continued)

Table 15 shows the encoding used in the opcodes to specify particular PP registers. A 3-bit register field contains the three least significant bits (LSBs). The register codes are used for the src, src1, src2, src3, src4, dst, dst1, dst2, d, reg, Ga, La, Gim/X, and Lim/X opcode fields. The four most significant bits (MSBs) specify the register bank which is concatenated to the register field for the full 7-bit code. The register bank codes are used for the dstbank, s1bnk, srcbank, Obank, bank, Adstbank, and As1bank opcode fields. When no associated bank is specified for a register field in the opcode, the D register bank is assumed. When the MSB of the bank code is not specified in the opcode (as in Obank and s1bnk), it is assumed to be 0, indicating a lower register.

Table 15. PP Register Codes

LOWER REGISTERS (MSB OF BANK = 0)						UPPER REGISTERS (MSB OF BANK = 1)					
CODING		REGISTER	CODING		REGISTER	CODING		REGISTER	CODING		REGISTER
BANK	REG		BANK	REG		BANK	REG		BANK	REG	
0000	000	a0	0100	000	d0	1000	000	reserved	1100	000	lc0
0000	001	a1	0100	001	d1	1000	001	reserved	1100	001	lc1
0000	010	a2	0100	010	d2	1000	010	reserved	1100	010	lc2
0000	011	a3	0100	011	d3	1000	011	reserved	1100	011	reserved
0000	100	a4	0100	100	d4	1000	100	reserved	1100	100	lr0
0000	101	reserved	0100	101	d5	1000	101	reserved	1100	101	lr1
0000	110	a6 (sp)	0100	110	d6	1000	110	reserved	1100	110	lr2
0000	111	a7 (zero)	0100	111	d7	1000	111	reserved	1100	111	reserved
0001	000	a8	0101	000	reserved	1001	000	reserved	1101	000	lrse0
0001	001	a9	0101	001	sr	1001	001	reserved	1101	001	lrse1
0001	010	a10	0101	010	mf	1001	010	reserved	1101	010	lrse2
0001	011	a11	0101	011	reserved	1001	011	reserved	1101	011	reserved
0001	100	a12	0101	100	reserved	1001	100	reserved	1101	100	lrs0
0001	101	reserved	0101	101	reserved	1001	101	reserved	1101	101	lrs1
0001	110	a14 (sp)	0101	110	reserved	1001	110	reserved	1101	110	lrs2
0001	111	a15 (zero)	0101	111	reserved	1001	111	reserved	1101	111	reserved
0010	000	x0	0110	000	reserved	1010	000	reserved	1110	000	ls0
0010	001	x1	0110	001	reserved	1010	001	reserved	1110	001	ls1
0010	010	x2	0110	010	reserved	1010	010	reserved	1110	010	ls2
0010	011	reserved	0110	011	reserved	1010	011	reserved	1110	011	reserved
0010	100	reserved	0110	100	reserved	1010	100	reserved	1110	100	le0
0010	101	reserved	0110	101	reserved	1010	101	reserved	1110	101	le1
0010	110	reserved	0110	110	reserved	1010	110	reserved	1110	110	le2
0010	111	reserved	0110	111	reserved	1010	111	reserved	1110	111	reserved
0011	000	x8	0111	000	pc/call	1011	000	reserved	1111	000	reserved
0011	001	x9	0111	001	ipa/br	1011	001	reserved	1111	001	reserved
0011	010	x10	0111	010	ipe †	1011	010	reserved	1111	010	reserved
0011	011	reserved	0111	011	iprs	1011	011	reserved	1111	011	reserved
0011	100	reserved	0111	100	inten	1011	100	reserved	1111	100	tag0 †
0011	101	reserved	0111	101	intflg	1011	101	reserved	1111	101	tag1 †
0011	110	reserved	0111	110	comm	1011	110	reserved	1111	110	tag2 †
0011	111	reserved	0111	111	lctl	1011	111	reserved	1111	111	tag3 †

† Read only



data unit operation code

For data unit opcode format A, a 4-bit operation code specifies one of 16 six-operand operations and an associated data path. See Figure 45.

Table 16. Six-Operand Format Operation Codes

oper FIELD BIT				OPERATION TYPE
60	59	58	57	
0	u	0	s	MPY ADD
0	u	1	f	MPYU EALU
1	0	f	k	EALU ROTATE
1	0	1	0	divi
1	1	u	s	SPY SADD

Legend:

- u Unsigned
- f 1s complement EALU function code
- s Subtract
- k Use mask or mf expander

operation class code

The base set ALU opcodes (formats B, C, D) use an operation-class code to specify one of eight different routings to the A, B, and C ports of the ALU. See Figure 45.

Table 17. Base Set ALU Class Summary

CLASS	DESTINATION	A PORT	B PORT			C PORT
000	dst	src2	src1	\\		@mf
001	dst	dstc	src1		d0	src2
010	dst	dstc	src1	\\		%src2
011	dst	dstc	src1	\\	src2	%src2
100	dst	src2	src1	\\	d0	%d0
101	dst	src2	src1	\\	d0	@mf
110	dst	dstc	src1			src2
111	dst	src1	1	\\	src2	src2

Legend:

- \\ Rotate left
- @mf Expand function
- % Mask generation
- dstc Companion D register
- dst Destination D register or any register if dstbank or Adstbank is used with destination.
- src2 Source D register or immediate
- srd1 Source D register or any register if As1bank is used or any lower register if s1bnk is used

SMJ320C80 DIGITAL SIGNAL PROCESSOR

SGUS025B - AUGUST 1998 - REVISED JUNE 2002

ALU operation code

For base set ALU Boolean opcodes (A=0), the ALU function is formed by a sum of Boolean products selected by the ALU operation opcode bits as shown in Table 18. For base set arithmetic opcodes (A=1), the four odd ALU operation bits specify an arithmetic operation as described in Table 19 while the four even bits specify one of the ALU function modifiers as shown in Table 20. See Table 9 for a list of PP operators and Figure 45 for PP opcode formats.

Table 18. Base-Set ALU Boolean Function Codes

OPCODE BIT	PRODUCT TERM
58	A & B & C
57	~A & B & C
56	A & ~B & C
55	~A & ~B & C
54	A & B & ~C
53	~A & B & ~C
52	A & ~B & ~C
51	~A & ~B & ~C

Table 19. Base Set Arithmetics

OPCODE BITS				CARRY IN	ALGEBRAIC DESCRIPTION	NATURAL FUNCTION	MODIFIED FUNCTION (IF DIFFERENT FROM NATURAL FUNCTION)
57	55	53	51				
0	0	0	0	x			
0	0	0	1	1	A - (B C)	A - B <1<	
0	0	1	0	0	A + (B & ~C)	A + B <0<	
0	0	1	1	1	A - C	A - C	
0	1	0	0	1	A - (B ~C)	A - B >1>	(A - (B & C)) if sign=0
0	1	0	1	1	A - B	A - B	
0	1	1	0	C(n)	A - (B & @mf -B & ~@mf)	A + B / A - B	if class 0 or 5
				1/0	A + B	A + B / A - B	if class 1-4 or 6-7, A-B if sign=1
0	1	1	1	1	A - (B & C)	A - B >0>	
1	0	0	0	0	A + (B & C)	A + B >0>	
1	0	0	1	~C(n)	A + (B & @mf -B & ~@mf)	A - B / A + B	if class 0 or 5
				0/1	A - B	A - B / A + B	if class 1-4 or 6-7, A+B if sign=1
1	0	1	0	0	A + B	A + B	
1	0	1	1	0	A + (B ~C)	A + B >1>	(A + (B & C)) if sign=0
1	1	0	0	0	A + C	A + C	
1	1	0	1	1	A - (B & ~C)	A - B <0<	
1	1	1	0	0	A + (B C)	A + B <1<	
1	1	1	1	0	(A & C) + (B & C)	field A + B	

Legend:

- C(n) LSB of each part of C port register
- >0> Zero-extend shift right
- <0< Zero-extend shift left
- >1> One-extend shift right
- <1< One-extend shift left



ALU-operation code (continued)

Table 20. Function Modifier Codes

FUNCTION MODIFIER BITS				MODIFICATION PERFORMED
58	56	54	52	
0	0	0	0	Normal operation
0	0	0	1	cin
0	0	1	0	%! if maskgen instruction, lmo if not maskgen
0	0	1	1	%! and cin if maskgen instruction, rmo if not maskgen
0	1	0	0	A port = 0
0	1	0	1	A port = 0 and cin
0	1	1	0	A port = 0 and %! if maskgen, lmbc if not maskgen
0	1	1	1	A port = 0, %! and cin if maskgen, rmbc if not maskgen
1	0	0	0	mf bit(s) set by carry out(s). (mc)
1	0	0	1	mf bit(s) set based on status register MSS field. (me)
1	0	1	0	Rotate mf by Asize, mf bit(s) set by carry out(s). (mrc)
1	0	1	1	Rotate mf by Asize, mf bit(s) set based on status register MSS field. (mre)
1	1	0	0	Clear mf, mf bit(s) set by carry out(s). (mzc)
1	1	0	1	Clear mf, mf bit(s) set based on status register MSS field. (mze)
1	1	1	0	No setting of bits in mf register. (mx)
1	1	1	1	Reserved

Legend:

cin	Carry in from sr(C)	%!	Modified mask generator
lmbc	Leftmost-bit change	rmbc	Rightmost-bit change
lmo	Leftmost one	rmo	Rightmost one

miscellaneous operation code

For data-unit opcode format E, the operation field selects one of the miscellaneous operations.

Table 21. Miscellaneous Operation Codes

OPCODE BITS					MNEMONIC	OPERATION
43	42	41	40	39		
0	0	0	0	0	nop	No data-unit operation. Status not modified
0	0	0	0	1	reserved	
0	0	0	1	0	eint	Global-interrupt enable
0	0	0	1	1	dint	Global-interrupt disable
0	0	1	x	x	reserved	
0	1	x	x	x	reserved	
1	x	x	x	x	reserved	

SMJ320C80 DIGITAL SIGNAL PROCESSOR

SGUS025B - AUGUST 1998 - REVISED JUNE 2002

addressing mode codes

The Lmode (bits 35–38) and Gmode (bits 13–16) of the opcode specify the local and global transfer for various parallel transfer opcode formats (Lmode in formats 1, 2, 3, 4, and 6 and Gmode in formats 1, 5, and 9). See Figure 45 for PP opcode formats. Table 22 shows the coding for the addressing mode fields.

Table 22. Addressing Mode Codes

CODING	EXPRESSION	DESCRIPTION
00xx		Nop (nonaddressing mode operation)
0100	*(an ++= xm)	Postaddition of index register, with modify
0101	*(an --= xm)	Postsubtraction of index register, with modify
0110	*(an ++= imm)	Postaddition of immediate, with modify
0111	*(an --= imm)	Postsubtraction of immediate, with modify
1000	*(an + xm)	Preaddition of index register
1001	*(an - xm)	Presubtraction of index register
1010	*(an + imm)	Preaddition of immediate
1011	*(an - imm)	Presubtraction of immediate
1100	*(an += xm)	Preaddition of index register, with modify
1101	*(an -= xm)	Presubtraction of index register, with modify
1110	*(an += imm)	Preaddition of immediate, with modify
1111	*(an -= imm)	Presubtraction of immediate, with modify

Legend:

- an Address register in local/global (l/g) address unit
- imm Immediate offset
- xm Index register in same unit as an register

L, e codes

The L and e bits combine to specify the type of parallel transfer performed. For the local transfer, L and e are bits 21 and 31, respectively. For the global transfer, L and e are bits 17 and 9, respectively. See Figure 45 for PP opcode formats.

Table 23. Parallel Transfer Type

L	e	PARALLEL TRANSFER
0	0	Store
0	1	Address unit arithmetic
1	0	Zero-extend load
1	1	Sign-extend load

size codes

The size code specifies the data transfer size. For field moves (parallel transfer format 3), only byte and halfword data sizes are valid.

Table 24. Transfer Data Size

CODING	DATA SIZE
00	Byte (8 bits)
01	Halfword (16 bits)
10	Word (32 bits)
11	Reserved

relative-addressing mode codes

The Lrm and Grm opcode fields allow the local-address or global-address units, respectively, to select PP-relative addressing as shown in Table 25.

Table 25. Relative-Addressing Mode Codes

CODING	RELATIVE-ADDRESSING MODE
00	Normal (absolute addressing)
01	Reserved
10	PP-relative dba
11	PP-relative pba

Legend:

dba - Data RAM 0 base is base address

pba - Paramater RAM base is base address

condition codes

In the four conditional parallel transfer opcodes (formats 7–10), the condition code field specifies one of 16 condition codes to be applied to the data unit operation source, data unit result, or global transfer based on the settings of the c, r, and g bits, respectively. Table 26 shows the condition codes. For the 32-bit immediate data unit opcode (format D), the condition applies to the data unit result only. See Figure 45 for PP opcode formats.

Table 26. Condition Codes

CONDITION BITS				MNEMONIC	DESCRIPTION	STATUS BIT COMBINATION
35	34	33	32			
0	0	0	0	u	Unconditional (default)	None
0	0	0	1	p	Positive	$\sim N$ & $\sim Z$
0	0	1	0	ls	Lower than or same	$\sim C$ Z
0	0	1	1	hi	Higher than	C & $\sim Z$
0	1	0	0	lt	Less than	$(N \& \sim V) (\sim N \& V)$
0	1	0	1	le	Less than or equal	$(N \& \sim V) (\sim N \& V) Z$
0	1	1	0	ge	Greater than or equal	$(N \& V) (\sim N \& \sim V)$
0	1	1	1	gt	Greater than	$(N \& V \& \sim Z) (\sim N \& \sim V \& \sim Z)$
1	0	0	0	hs, c	Higher than or same, carry	C
1	0	0	1	lo, nc	Lower than, no carry	$\sim C$
1	0	1	0	eq, z	Equal, zero	Z
1	0	1	1	ne, nz	Not equal, not zero	$\sim Z$
1	1	0	0	v	Overflow	V
1	1	0	1	nv	No overflow	$\sim V$
1	1	1	0	n	Negative	N
1	1	1	1	nn	Nonnegative	$\sim N$

EALU operations

Extended ALU (EALU) operations allow the execution of more advanced ALU functions than those specified in the base set ALU opcodes. The opcode for EALU instructions contains the operands for the operation while the d0 register extends the opcode by specifying the EALU operation to be performed. The format of d0 for EALU operations is shown in Figure 24.

SMJ320C80 DIGITAL SIGNAL PROCESSOR

SGUS025B - AUGUST 1998 - REVISED JUNE 2002

EALU Boolean functions

EALU operations support all 256 Boolean ALU functions plus the flexibility to add 1 or a carry-in to Boolean sum. The Boolean function performed by the ALU is:

$$(F0 \& (\sim A \& \sim B \& \sim C)) \mid (F1 \& (A \& \sim B \& \sim C)) \mid (F2 \& (\sim A \& B \& \sim C)) \mid (F3 \& (A \& B \& \sim C)) \mid (F4 \& (\sim A \& \sim B \& C)) \mid (F5 \& (A \& \sim B \& C)) \mid (F6 \& (\sim A \& B \& C)) \mid (F7 \& (A \& B \& C)) [+1 \mid +cin]$$

Table 27. EALU Boolean Function Codes

d0 BIT	ALU FUNCTION SIGNAL	PRODUCT TERM
26	F7	A & B & C
25	F6	$\sim A \& B \& C$
24	F5	A & $\sim B \& C$
23	F4	$\sim A \& \sim B \& C$
22	F3	A & B & $\sim C$
21	F2	$\sim A \& B \& \sim C$
20	F1	A & $\sim B \& \sim C$
19	F0	$\sim A \& \sim B \& \sim C$

EALU arithmetic functions

EALU operations support all 256 arithmetic functions provided by the three-input ALU plus the flexibility to add 1 or a carry-in to the result. The arithmetic function performed by the ALU is:

$$f(A,B,C) = A \& f1(B,C) + f2(B,C) [+1 \mid cin]$$

f1(B,C) and f2(B,C) are independent Boolean combinations of the B and C ALU inputs. The ALU function is specified by selecting the desired f1 and f2 subfunction and then XORing the f1 and f2 code from Table 28 to create the ALU function code for bits 19–26 of d0. Additional operations such as absolute values and signed shifts can be performed using d0 bits which control the ALU function based on the sign of one of the inputs.

Table 28. ALU f1(B,C) and f2(B,C) Subfunctions

f1 CODE	f2 CODE	SUBFUNCTION	COMMON USAGE
00	00	0	Zero the term
AA	FF	-1	-1 (All 1s)
88	CC	B	B
22	33	$\sim B - 1$	Negate B
A0	F0	C	C
0A	0F	$\sim C - 1$	Negate C
80	C0	B & C	Force bits in B to 0 where bits in C are 0
2A	3F	$\sim(B \& C) - 1$	Force bits in B to 0 where bits in C are 0 and negate
A8	FC	B C	Force bits in B to 1 where bits in C are 1
02	03	$\sim(B C) - 1$	Force bits in B to 1 where bits in C are 1 and negate
08	0C	B & $\sim C$	Force bits in B to 0 where bits in C are 1
A2	F3	$\sim(B \& \sim C) - 1$	Force bits in B to 0 where bits in C are 1 and negate
8A	CF	B $\sim C$	Force bits in B to 1 where bits in C are 0
20	30	$\sim(B \sim C) - 1$	Force bits in B to 1 where bits in C are 0 and negate
28	3C	$(B \& \sim C) \mid ((\sim B - 1) \& C)$	Choose B if C = all 0s and $\sim B$ if C = all 1s
82	C3	$(B \& C) \mid ((\sim B - 1) \& \sim C)$	Choose B if C = all 1s and $\sim B$ if C = all 0s



TC architecture

The transfer controller (TC) is a combined memory controller and DMA (direct memory access) machine. It handles the movement of data within the 'C80 system as requested by the master processor, parallel processors, and external devices. The transfer controller performs the following data movement and memory control functions:

- MP and PP instruction cache fills
- MP data-cache fills and dirty block write-back
- MP and PP direct external accesses (DEAs)
- MP and PP packet transfers
- Externally initiated packet transfers (XPTs)
- Shift register transfer (SRT) packet transfers for updating VRAM-based frame buffers
- DRAM refresh
- Host bus request

TC functional block diagram

Figure 46 shows a functional block diagram of the transfer controller. Key features of the TC include:

- Crossbar interface
 - 64-bit data path
 - Single-cycle access
- External memory interface
 - 4G-Byte address range
 - Programmable:
 - bus size: 8-, 16-, 32-, or 64-bits
 - page size
 - bank size
 - address multiplexing
 - cycle timing
 - block-write mode
 - bank priority
 - Big- or little-endian operation
- Cache, VRAM, refresh controller
 - Programmable refresh rate
 - VRAM block-write support
- Independent Src and Dst addressing
 - Autonomous addressing based on packet-transfer parameters
 - Data read and write at different rates
 - Numerous data merging and alignment functions performed during transfer
- Intelligent request prioritization

TC functional block diagram (continued)

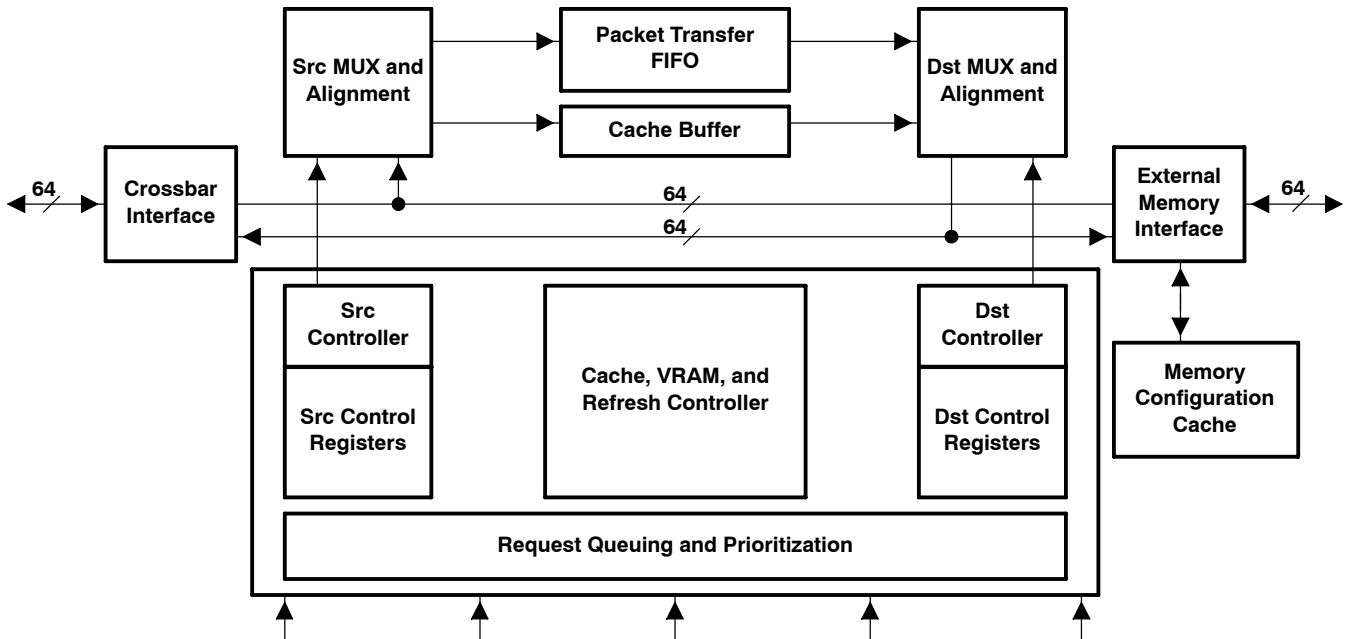

Figure 46. TC Block Diagram

TC registers

The TC contains four on-chip memory-mapped registers accessible by the MP.

refresh control (REFCNTL) register (0x01820000)

The REFCNTL register controls refresh cycles.

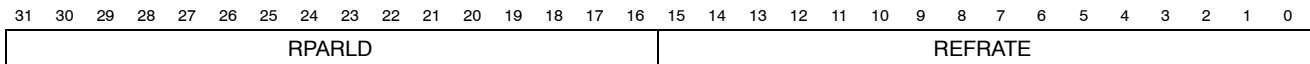

RPARLD Refresh Pseudo-Address Reload Value **REFRATE** Refresh Interval (in clock cycles)

Figure 47. REFCNTL Register

packet-transfer minimum (PTMIN) register (0x01820004)

The PTMIN register determines the minimum number of cycles that a packet transfer executes before being suspended by a higher priority packet transfer.

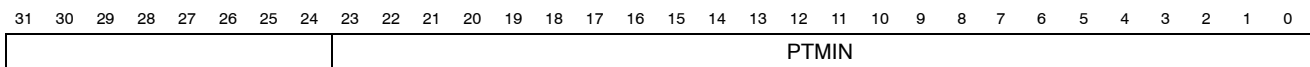

Figure 48. PTMIN Register

PT maximum (PTMAX) register (0x01820008)

The PTMAX register determines the maximum number of cycles after PTMIN has elapsed that a packet transfer executes before timing out.

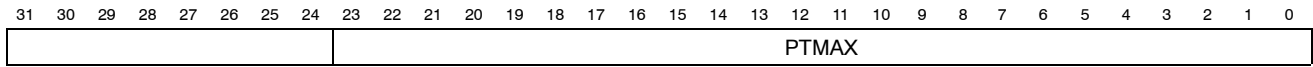
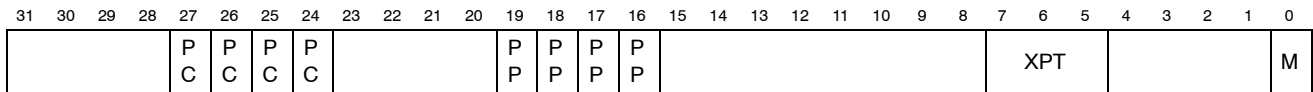

Figure 49. PTMAX Register

fault status (FLTSTS) register (0x0182000C)

The FLTSTS register indicates the cause of a memory access fault. Fault status bits are cleared by writing a 1 to the appropriate bit.



PP # 3 2 1 0	PP# 3 2 1 0		
PC PPx Cache / DEA Fault		XPT Faulting XPT	
PP PPx Packet-Transfer Fault		M MP Packet-Transfer Fault	

Figure 50. FLTSTS Register

packet-transfer parameters

The most efficient method for data movement in a SMJ320C80 system is through the use of packet transfers (PTs). Packet transfers allow the TC to move blocks of data autonomously between a specified src and dst memory region. Requests for the TC to execute a packet transfer may be made by the MP, PPs, or external devices. A packet-transfer parameter table describing the data packet and how it is to be transferred must be programmed in on-chip memory before the transfer is requested. The TC on the SMJ320C80 supports short- and long-form packet transfers. The PT parameter table format is shown in Figure 51.

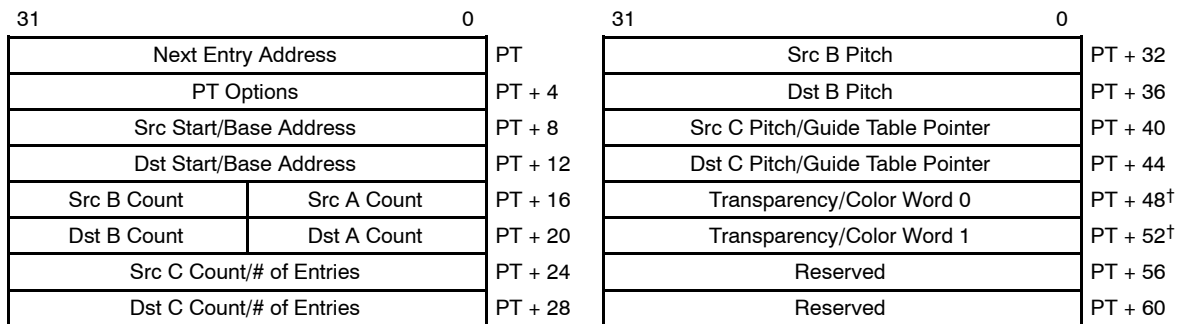

PT - 64-byte aligned on-chip starting address of parameter table

† Words are swapped in big-endian mode

Figure 51. Packet-Transfer Parameter Table

SMJ320C80 DIGITAL SIGNAL PROCESSOR

SGUS025B - AUGUST 1998 - REVISED JUNE 2002

PT-options field

The PT-options field of the parameter table controls the type of src and dst transfer that the TC performs. The format of the options field is shown in Figure 52.

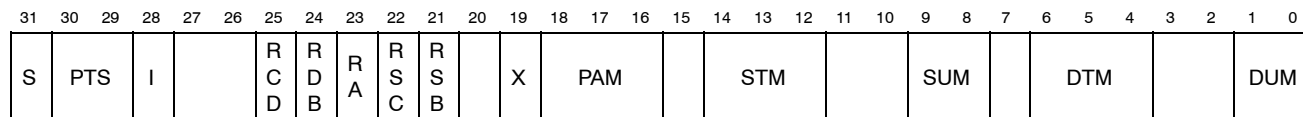

- | | | | |
|-----|---------------------------------|---------|---------------------------|
| S | Stop bit | PAM | PT Access Mode |
| PTS | PT status | | 000 - Normal |
| | 00 - Active | | 001 - PDT |
| | 01 - Suspended | | 010 - Block Write |
| I | Interrupt when complete | | 011 - SRT |
| RDC | Reverse dst C addressing | STM/DTM | src/dst Transfer Mode |
| RDB | Reverse dst B addressing | | 000 - Dimensioned |
| RA | Reverse A addressing | | 001 - Fill [†] |
| RSC | Reverse src C addressing | | 010 - Reserved |
| RSB | Reverse src B addressing | | 011 - LUT [†] |
| X | Exchange src and dst parameters | SUM/DUM | src/dst update mode |
| | | | 00 - None |
| | | | 01 - Add B Pitch |
| | | | 100 - Var Delta-Guided |
| | | | 101 - Var Offset-Guided |
| | | | 110 - Fixed Delta-Guided |
| | | | 111 - Fixed Offset-Guided |
| | | | 01 - Add C Pitch |
| | | | 11 - Add C Pitch/Reverse |

[†] Valid for src only.

Figure 52. PT-Options Field



local memory interface

status codes

Status codes are output on STATUS[5:0] to describe the cycle being performed. During row time, STATUS[5:0] pins indicate the type of cycle being performed. The cycle type can be latched using \overline{RL} or \overline{RAS} and used by external logic to perform memory bank decoding or to enable special hardware features. During column time, the STATUS[5:0] pins indicate the requesting processor or special column information.

Table 29. Row-Time Status Codes

STATUS[5:0]	CYCLE TYPE	STATUS[5:0]	CYCLE TYPE
0 0 0 0 0 0	Normal Read	1 0 0 0 0 0	Reserved
0 0 0 0 0 1	Normal Write	1 0 0 0 0 1	Reserved
0 0 0 0 1 0	Refresh	1 0 0 0 1 0	Reserved
0 0 0 0 1 1	SDRAM DCAB	1 0 0 0 1 1	Reserved
0 0 0 1 0 0	Peripheral Device PT Read	1 0 0 1 0 0	XPT1 Read
0 0 0 1 0 1	Peripheral Device PT Write	1 0 0 1 0 1	XPT1 Write
0 0 0 1 1 0	Reserved	1 0 0 1 1 0	XPT1 PDPT Read
0 0 0 1 1 1	Reserved	1 0 0 1 1 1	XPT1 PDPT Write
0 0 1 0 0 0	Reserved	1 0 1 0 0 0	XPT2 Read
0 0 1 0 0 1	Block-Write PT	1 0 1 0 0 1	XPT2 Write
0 0 1 0 1 0	Reserved	1 0 1 0 1 0	XPT2 PDPT Read
0 0 1 0 1 1	Reserved	1 0 1 0 1 1	XPT2 PDPT Write
0 0 1 1 0 0	SDRAM MRS	1 0 1 1 0 0	XPT3 Read
0 0 1 1 0 1	Load Color Register	1 0 1 1 0 1	XPT3 Write
0 0 1 1 1 0	Reserved	1 0 1 1 1 0	XPT3 PDPT Read
0 0 1 1 1 1	Reserved	1 0 1 1 1 1	XPT3 PDPT Write
0 1 0 0 0 0	Frame 0 Read Transfer	1 1 0 0 0 0	XPT4/SAM1 Read
0 1 0 0 0 1	Frame 0 Write Transfer	1 1 0 0 0 1	XPT4/SAM1 Write
0 1 0 0 1 0	Frame 0 Split-Read Transfer	1 1 0 0 1 0	XPT4/SAM1 PDPT Read
0 1 0 0 1 1	Frame 0 Split-Write Transfer	1 1 0 0 1 1	XPT4/SAM1 PDPT Write
0 1 0 1 0 0	Frame 1 Read Transfer	1 1 0 1 0 0	XPT5/SOF1 Read
0 1 0 1 0 1	Frame 1 Write Transfer	1 1 0 1 0 1	XPT5/SOF1 Write
0 1 0 1 1 0	Frame 1 Split-Read Transfer	1 1 0 1 1 0	XPT5/SOF1 PDPT Read
0 1 0 1 1 1	Frame 1 Split-Write Transfer	1 1 0 1 1 1	XPT5/SOF1 PDPT Write
0 1 1 0 0 0	Reserved	1 1 1 0 0 0	XPT6/SAM0 Read
0 1 1 0 0 1	Reserved	1 1 1 0 0 1	XPT6/SAM0 Write
0 1 1 0 1 0	Reserved	1 1 1 0 1 0	XPT6/SAM0 PDPT Read
0 1 1 0 1 1	Reserved	1 1 1 0 1 1	XPT6/SAM0 PDPT Write
0 1 1 1 0 0	PT Read Transfer	1 1 1 1 0 0	XPT7/SOF0 Read
0 1 1 1 0 1	PT Write Transfer	1 1 1 1 0 1	XPT7/SOF0 Write
0 1 1 1 1 0	Reserved	1 1 1 1 1 0	XPT7/SOF0 PDPT Read
0 1 1 1 1 1	Idle	1 1 1 1 1 1	XPT7/SOF0 PDPT Write

SMJ320C80 DIGITAL SIGNAL PROCESSOR

SGUS025B - AUGUST 1998 - REVISED JUNE 2002

local memory interface (continued)

Table 30. Column-Time Status Codes

STATUS[5:0]	CYCLE TYPE	STATUS[5:0]	CYCLE TYPE
0 0 0 0 0 0	PP0 Low-Priority Packet Transfer	1 0 0 0 0 0	Reserved
0 0 0 0 0 1	PP0 High-Priority Packet Transfer	1 0 0 0 0 1	Reserved
0 0 0 0 1 0	PP0 Instruction Cache	1 0 0 0 1 0	Reserved
0 0 0 0 1 1	PP0 DEA	1 0 0 0 1 1	Reserved
0 0 0 1 0 0	PP1 Low-Priority Packet Transfer	1 0 0 1 0 0	Reserved
0 0 0 1 0 1	PP1 High-Priority Packet Transfer	1 0 0 1 0 1	Reserved
0 0 0 1 1 0	PP1 Instruction Cache	1 0 0 1 1 0	Reserved
0 0 0 1 1 1	PP1 DEA	1 0 0 1 1 1	Reserved
0 0 1 0 0 0	PP2 Low-Priority Packet Transfer	1 0 1 0 0 0	Reserved
0 0 1 0 0 1	PP2 High-Priority Packet Transfer	1 0 1 0 0 1	Reserved
0 0 1 0 1 0	PP2 Instruction Cache	1 0 1 0 1 0	Reserved
0 0 1 0 1 1	PP2 DEA	1 0 1 0 1 1	Reserved
0 0 1 1 0 0	PP3 Low-Priority Packet Transfer	1 0 1 1 0 0	Reserved
0 0 1 1 0 1	PP3 High-Priority Packet Transfer	1 0 1 1 0 1	Reserved
0 0 1 1 1 0	PP3 Instruction Cache	1 0 1 1 1 0	Reserved
0 0 1 1 1 1	PP3 DEA	1 0 1 1 1 1	Reserved
0 1 0 0 0 0	MP Low-Priority Packet Transfer	1 1 0 0 0 0	Reserved
0 1 0 0 0 1	MP High-Priority Packet Transfer	1 1 0 0 0 1	Reserved
0 1 0 0 1 0	MP Urgent Packet Transfer (Low)	1 1 0 0 1 0	Reserved
0 1 0 0 1 1	MP Urgent Packet Transfer (High)	1 1 0 0 1 1	Reserved
0 1 0 1 0 0	XPT/VCPT in Progress	1 1 0 1 0 0	Reserved
0 1 0 1 0 1	XPT/VCPT Complete	1 1 0 1 0 1	Reserved
0 1 0 1 1 0	MP Instruction Cache (Low)	1 1 0 1 1 0	Reserved
0 1 0 1 1 1	MP Instruction Cache (High)	1 1 0 1 1 1	Reserved
0 1 1 0 0 0	MP DEA (Low)	1 1 1 0 0 0	Reserved
0 1 1 0 0 1	MP DEA (High)	1 1 1 0 0 1	Reserved
0 1 1 0 1 0	MP Data Cache (Low)	1 1 1 0 1 0	Reserved
0 1 1 0 1 1	MP Data Cache (High)	1 1 1 0 1 1	Reserved
0 1 1 1 0 0	Frame 0	1 1 1 1 0 0	Reserved
0 1 1 1 0 1	Frame 1	1 1 1 1 0 1	Reserved
0 1 1 1 1 0	Refresh	1 1 1 1 1 0	Reserved
0 1 1 1 1 1	Idle	1 1 1 1 1 1	Write Drain / SDRAM DCAB

Low - MP operating in low-(normal) priority mode

High - MP operating in high-priority mode



address multiplexing

To support various RAM devices, the SMJ320C80 can provide multiplexed row and column addresses on its address bus. A full 32-bit address is always output at row time. The alignment of column addresses is configured by the value input on the AS[2:0] pins at row time.

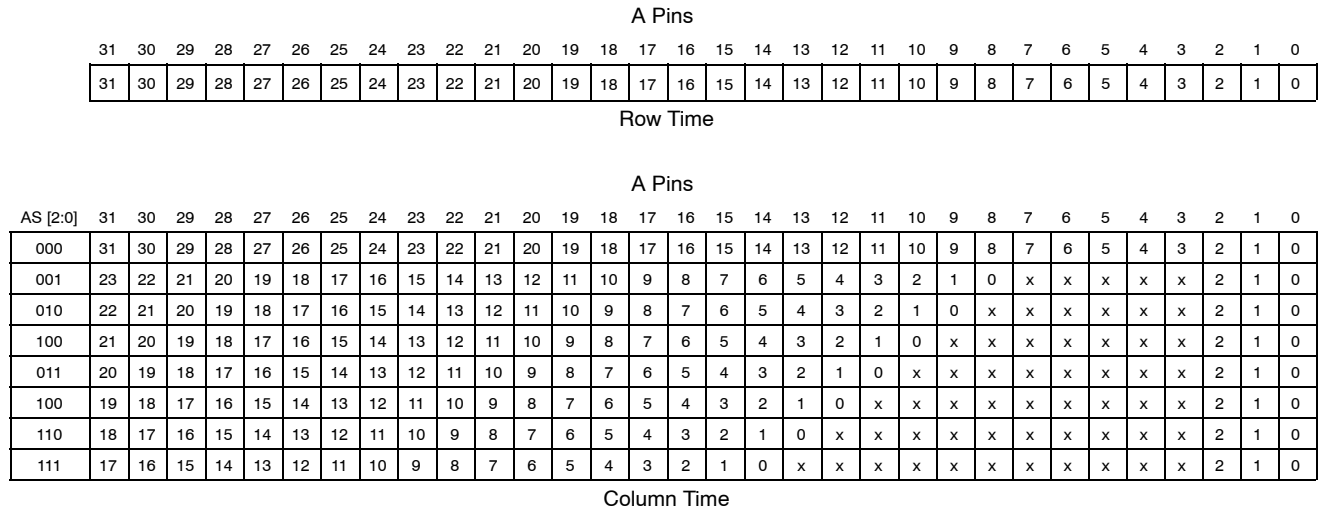

Figure 53. Address Multiplexing

dynamic bus sizing

The 'C80 supports data bus sizes of 8, 16, 32, or 64 bits. The value input on the BS[1:0] pins at row time indicates the bus size of the addressed memory. This determines the maximum number of bytes which the 'C80 can transfer during each column access. If the number of bytes to be transferred exceeds the bus size, multiple accesses are performed automatically to complete the transfer.

Table 31. Bus Size Selection

BS[1:0]	BUS SIZE
0 0	8 bits
0 1	16 bits
1 0	32 bits
1 1	64 bits

The selected bus size also determines which portion of the data bus is used for the transfer. For 64-bit memory, the entire data bus is used. For 32-bit memory, D[31:0] are used in little-endian mode and D[63:32] are used in big-endian mode. 16-bit buses use D[15:0] and D[63:48] and 8-bit buses use D[7:0] and D[63:56] for little- and big-endian modes, respectively. The 'C80 always aligns data to the proper portion of the bus and activates the appropriate $\overline{\text{CAS}}$ strobes to ensure that only valid bytes are transferred.

cycle time selection

The 'C80 supports eight basic sets of memory timings to support various memory types directly. The cycle timing is selected by the value input on the CT[2:0] pins at row time. The selected timing remains in effect until the next row access.

Table 32. Cycle-Timing Selection

CT[2:0]	MEMORY TIMING
0 0 0	Pipelined (Burst Length 1) SDRAM, CAS Latency of 2
0 0 1	Pipelined (Burst Length 1) SDRAM, CAS Latency of 3
0 1 0	Interleaved (Burst Length 2) SDRAM, CAS Latency of 2
0 1 1	Interleaved (Burst Length 2) SDRAM, CAS Latency of 3
1 0 0	Pipelined 1 Cycle/Column
1 0 1	Nonpipelined 1 Cycle/Column
1 1 0	2 Cycle/Column
1 1 1	3 Cycle/Column

page sizing

Whenever an external memory access occurs, the TC records the 22 most significant bits of the address in its internal LASTPAGE register. The address of each subsequent (column) access is compared to this value. The page size value input on the PS[3:0] pins determines which bits of LASTPAGE are used for this comparison. If a difference exists between the enabled LASTPAGE bits and the corresponding bits of the next access, then the page has changed and the next memory access begins with a new row-address cycle.

Table 33. Page-Size Selection

PS[3:0]	ADDRESS BITS COMPARED	PAGE SIZE (BYTES)
0 0 0 0	A[31:6]	64
0 0 0 1	A[31:7]	128
0 0 1 0	A[31:8]	256
0 0 1 1	A[31:9]	512
0 1 0 0	A[31:10]	1K
0 1 0 1	A[31:18]	256K
0 1 1 0	A[31:19]	512K
0 1 1 1	A[31:20]	1M
1 0 0 0	A[31:0]	1-8†
1 0 0 1	A[31:11]	2K
1 0 1 0	A[31:12]	4K
1 0 1 1	A[31:13]	8K
1 1 0 0	A[31:14]	16K
1 1 0 1	A[31:15]	32K
1 1 1 0	A[31:16]	64K
1 1 1 1	A[31:17]	128K

† PS[3:0] = 1000 disables page-mode cycles so that the effective page size is the same as the bus size



block-write support

The SMJ320C80 supports three modes of VRAM block-write. The block-write mode is dynamically selectable so that software can specify block-writes regardless of the type of block-write the addressed memory supports. Block-writes are supported only for 64-bit buses. During block-write and load-color-register cycles, the BS[1:0] inputs determine which block mode will be used.

Table 34. Block-Write Selection

BS[1:0]	BLOCK-WRITE MODE
0 0	Simulated
0 1	Reserved
1 0	4x
1 1	8x

SDRAM support

The SMJ320C80 provides direct support for synchronous DRAM (SDRAM), synchronous VRAM (SVRAM), and synchronous graphics RAM (SGRAM). During 'C80 power-up refresh cycles, the external system must signal the presence of these memories by inputting a CT2 value of 0. This causes the 'C80 to perform special deactivate (DCAB) and mode register set (MRS) commands to initialize the synchronous RAMs. Figure 54 shows the MRS value generated by the 'C80.

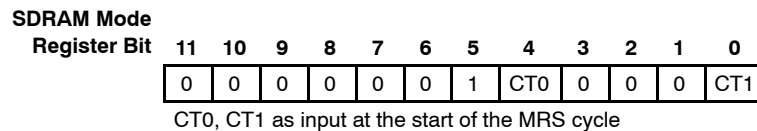

Figure 54. MRS Value

Because the MRS register is programmed through the SDRAM address inputs, the alignment of the MRS data to the 'C80 logical-address bits is adjusted for the bus size (see Figure 55). The appearance of the MRS bits on the 'C80 physical-address bus is dependent on the address multiplexing as selected by the AS[2:0] inputs.

BS[1:0]	'C80 LOGICAL ADDRESS BITS															
	A15	A14	A13	A12	A11	A10	A9	A8	A7	A6	A5	A4	A3	A2	A1	A0
0 0	X	X	X	X	11	10	9	8	7	6	5	4	3	2	1	0
0 1	X	X	X	11	10	9	8	7	6	5	4	3	2	1	0	X
1 0	X	X	11	10	9	8	7	6	5	4	3	2	1	0	X	X
1 1	X	11	10	9	8	7	6	5	4	3	2	1	0	X	X	X

Figure 55. MRS Value Alignment

memory cycles

SMJ320C80 external memory cycles are generated by the TC's external memory controller. The controller's state machine generates a sequence of states which define the transition of the memory interface signals. The state sequence is dependent on the cycle timing selected for the memory access being performed as shown in Figure 56. Memory cycles consist of row states and the column pipeline.

memory cycles (continued)

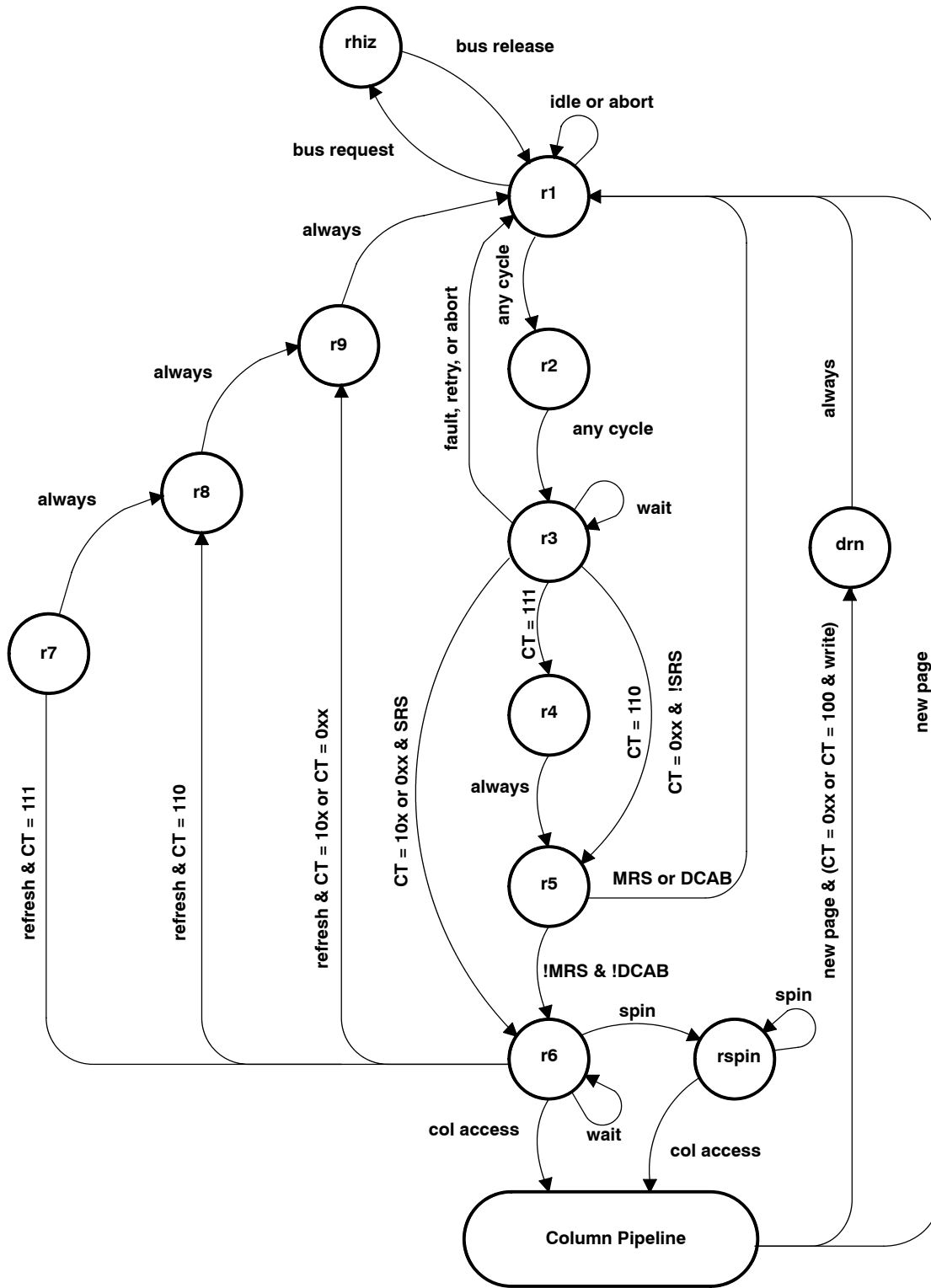

Figure 56. Memory Cycle State Diagram

row states

The row states make up the row time of each memory access. They occur when each new page access begins. The transition indicators determine the conditions that cause transitions to another state.

Table 35. Row States

STATE	DESCRIPTION
r1	Beginning state for all memory accesses. Outputs row address (A[31:0]) and cycle type (STATUS[5:0]) and drives control signals to their inactive state
r2	Common to all memory accesses. Asserts \overline{RL} and drives \overline{DDIN} according to the data transfer direction. AS[2:0], BS[1:0], CT[2:0], PS[3:0], and \overline{UTIME} inputs are sampled
r3	Common to all memory accesses. \overline{DBEN} is driven to its active level. For non-SDRAM, \overline{W} , $\overline{TRG/CAS}$, and DSF are driven to their active levels, and for non-SDRAM refreshes, all $\overline{CAS/DQM}$ strobes are activated. \overline{FAULT} , \overline{READY} , and \overline{RETRY} inputs are sampled.
r4	Inserted for 3 cycle/column accesses (CT=111) only. No signal transitions occur. \overline{RETRY} input is sampled.
r5	Common to SDRAM and 2 or 3 cycle/column accesses (CT=0xx or 11x). \overline{RAS} is driven low. \overline{W} is driven low for DCAB and MRS cycles and $\overline{TRG/CAS}$ is driven low for MRS and SDRAM refresh cycles.
r6	Common to all memory accesses. For SDRAM cycles, \overline{RAS} , $\overline{TRG/CAS}$, and \overline{W} are driven high. For non-SDRAM, \overline{RAS} is driven low (if not already) and \overline{W} , $\overline{TRG/CAS}$, and DSF are driven to their appropriate levels. \overline{DBEN} is driven low and \overline{READY} and \overline{RETRY} are sampled.
rspin	Additional state to allow TC column time pipeline to load. No signal transitions occur. \overline{RETRY} is sampled. The rspin state can, on occasion, repeat multiple times.
r7	Common to 2 and 3 cycle/column refreshes (CT=11x). Processor activity code is output on STATUS[5:0]. \overline{RETRY} input is sampled.
r8	For 3 cycle/column refreshes only (CT=111). No signal transitions occur. \overline{RETRY} input is sampled.
r9	Common to all refresh cycles. Processor activity code is output on STATUS[5:0] and \overline{RETRY} input is sampled.
drn	Occurs for SDRAM cycles (CT = 0xx) and pipelined 1 cycle/column writes only. For SDRAM cycles, \overline{RAS} , and \overline{W} are activated to perform a DCAB command. For pipelined writes, all $\overline{CAS/DQM}$ strobes are activated.
rhiz	High-impedance state. Occurs during host requests and repeats until bus is released by the host

Table 36. State Transition Indicators

INDICATOR	DESCRIPTION
any cycle	Continuation of current cycle
CT=xxx	State change occurs for indicated CT[2:0] value (as latched in r2 state)
abort	Current cycle aborted by TC in favor of higher-priority cycle
fault	\overline{FAULT} input sampled low (in r3 state), memory access faulted
retry	\overline{RETRY} input sampled low (in r3 state), row-time retry
wait	\overline{READY} input sampled low (in r3, r6, or last column state) repeat current state
spin	Internally generated wait state to allow TC pipeline to load
new page	The next access requires a page change (new row access)

external memory timing examples

The following sections contain descriptions of the 'C80 memory cycles and illustrate the signal transitions for those cycles. Memory cycles can be separated into two basic categories: DRAM-type cycles for use with DRAM-like devices, SRAM, and peripherals, and SDRAM-type cycles for use with SDRAM-like devices.

SMJ320C80 DIGITAL SIGNAL PROCESSOR

SGUS025B - AUGUST 1998 - REVISED JUNE 2002

DRAM-type cycles

The DRAM-type cycles are page-mode accesses consisting of a row access followed by one or more column accesses. Column accesses may be one, two, or three clock cycles in length with two and three cycle accesses allowing the insertion of wait states to accommodate slow devices. Idle cycles can occur after necessary column accesses have completed or between column accesses due to "bubbles" in the TC data-flow pipeline. The pipeline diagrams in Figure 57 show the pipeline stages for each access type and when the $\overline{\text{CAS}}/\text{DQM}$ signal corresponding to the column access is activated.

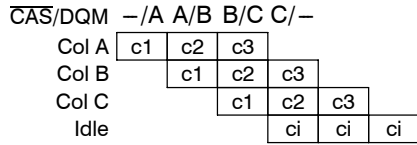

Pipelined 1-cycle/column EDO (CT = 0000)
reads, read transfers, split read transfers

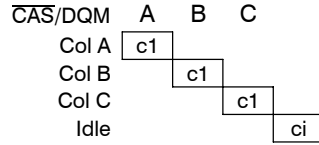

Pipelined 1-cycle/column (CT = 0000)
writes, load color register (LCR), block writes

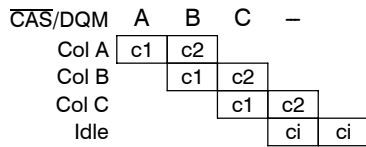

Nonpipelined 1-cycle/column EDO (CT = 0001)
reads, read transfers, split read transfers

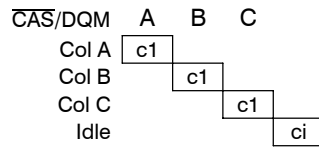

Nonpipelined 1-cycle/column (CT = 0001)
writes, LCRs, block writes

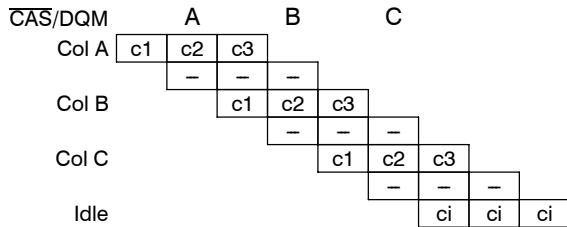

2-cycle/column EDO (CT = 0010)
reads, read transfers, split read transfers

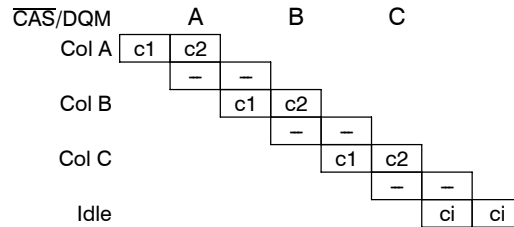

2-cycle/column (CT = 0010)
writes, LCRs, block writes

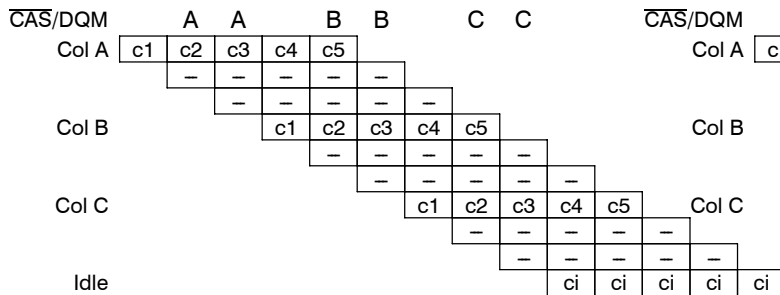

3-cycle/column EDO (CT = 0011)
reads, read transfers, split read transfers

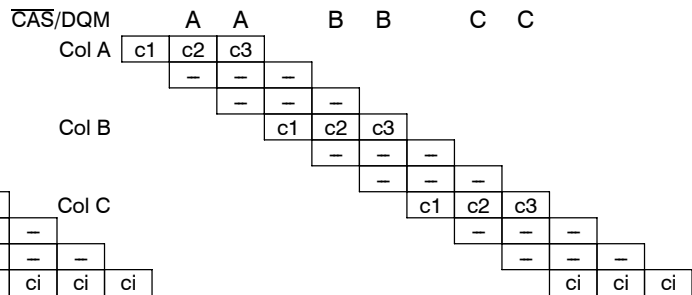

3-cycle/column (CT = 0011)
writes, LCRs, and block writes

Figure 57. DRAM Cycle Column Pipelines

read cycles

Read cycles transfer data or instructions from external memory to the 'C80. The cycles can occur as a result of a packet transfer, cache request, or DEA request. During the cycle, \overline{W} is held high, $\overline{TRG/CAS}$ is driven low after \overline{RAS} to enable memory output drivers and \overline{DBEN} and \overline{DDIN} are low so that data transceivers can drive into the 'C80. During column time, the TC places D[63:0] into the high-impedance state, allowing it to be driven by the memory and latches input data during the appropriate column state. The TC always reads 64 bits and extracts and aligns the appropriate bytes. Invalid bytes for bus sizes of less than 64 bits are discarded. During peripheral device packet transfers, \overline{DBEN} and \overline{DDIN} remain high.

SMJ320C80 DIGITAL SIGNAL PROCESSOR

SGUS025B - AUGUST 1998 - REVISED JUNE 2002

read cycles (continued)

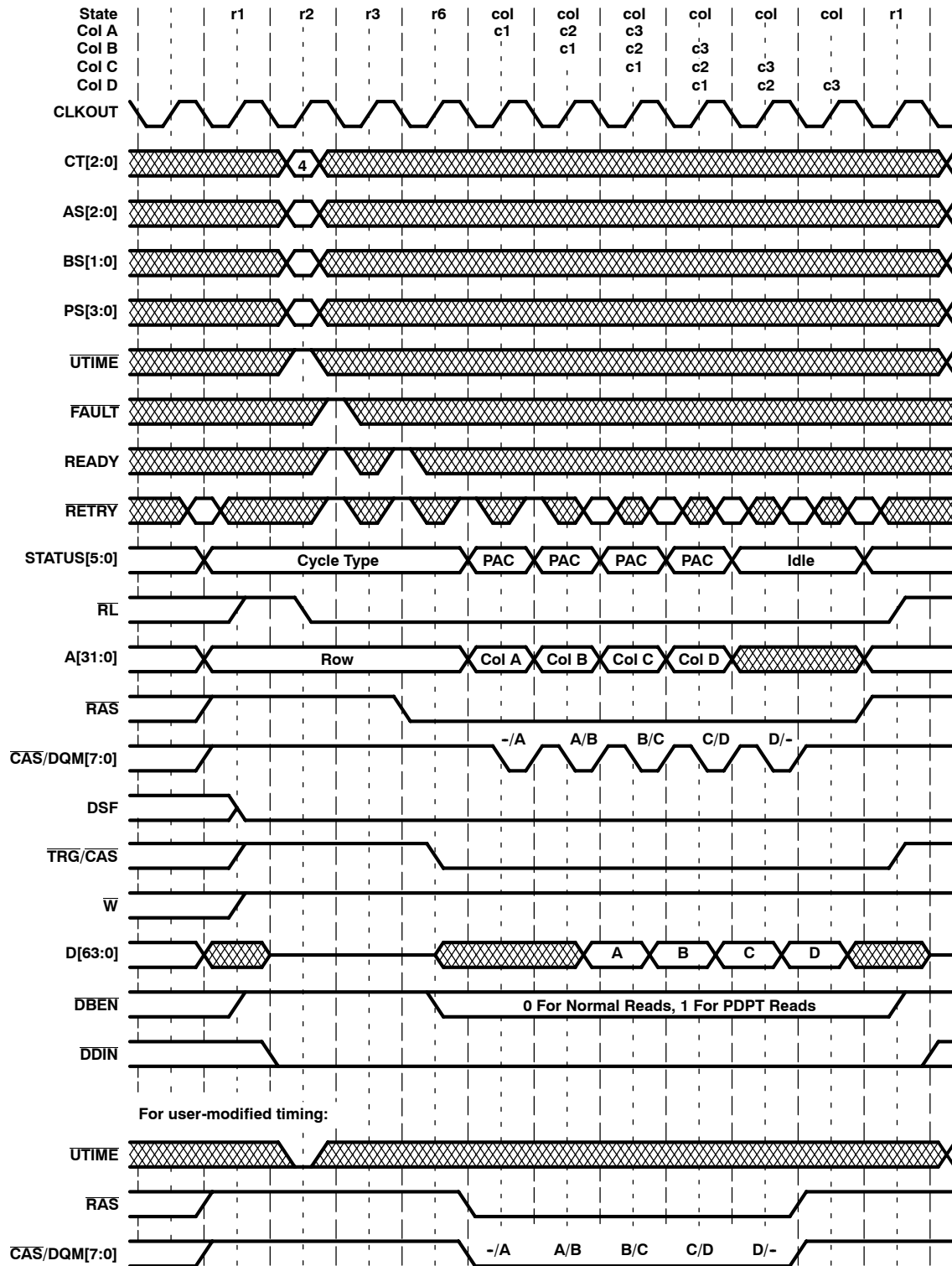

Figure 58. Pipelined 1-Cycle/Column Read-Cycle Timing



read cycles (continued)

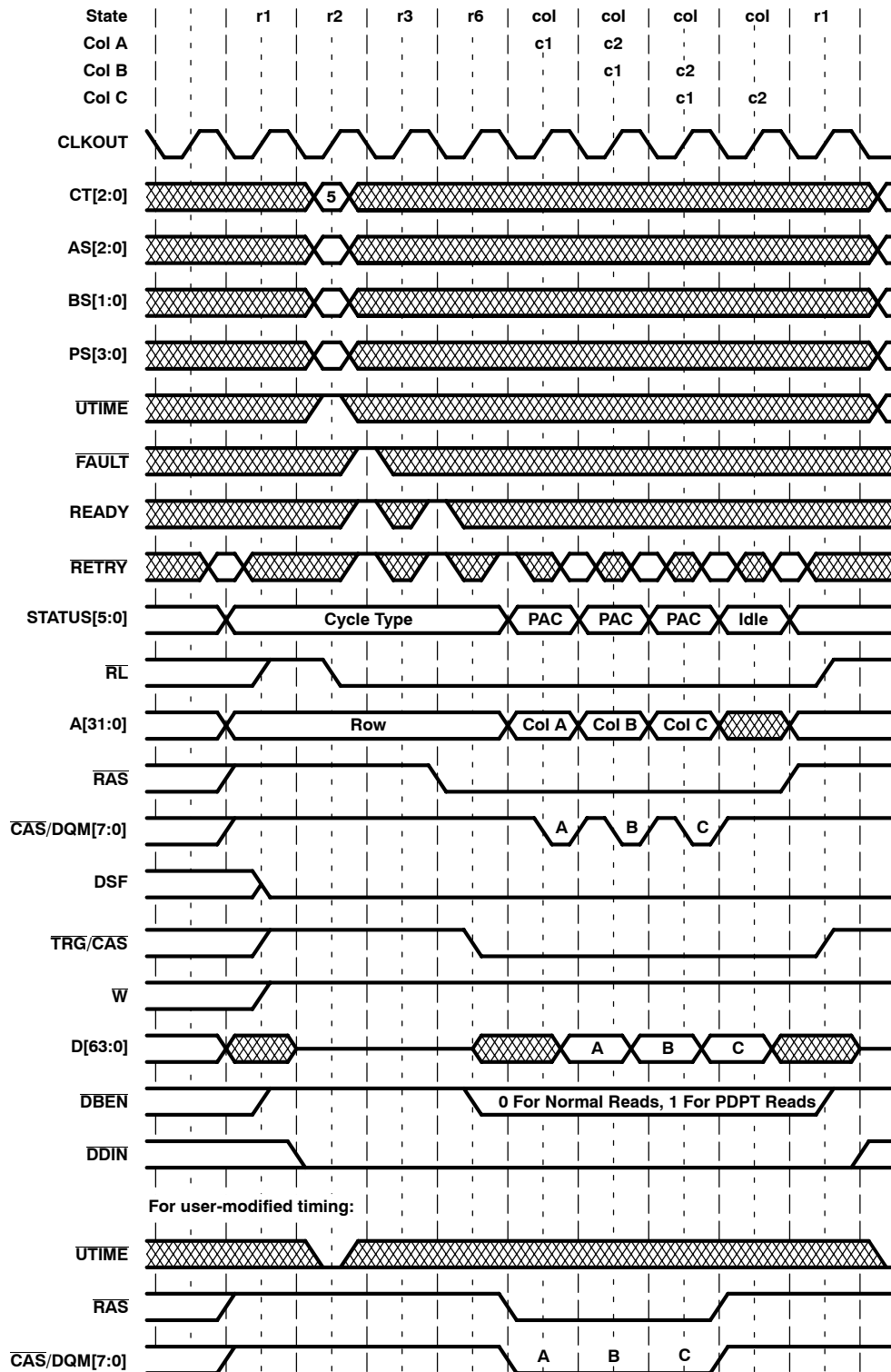
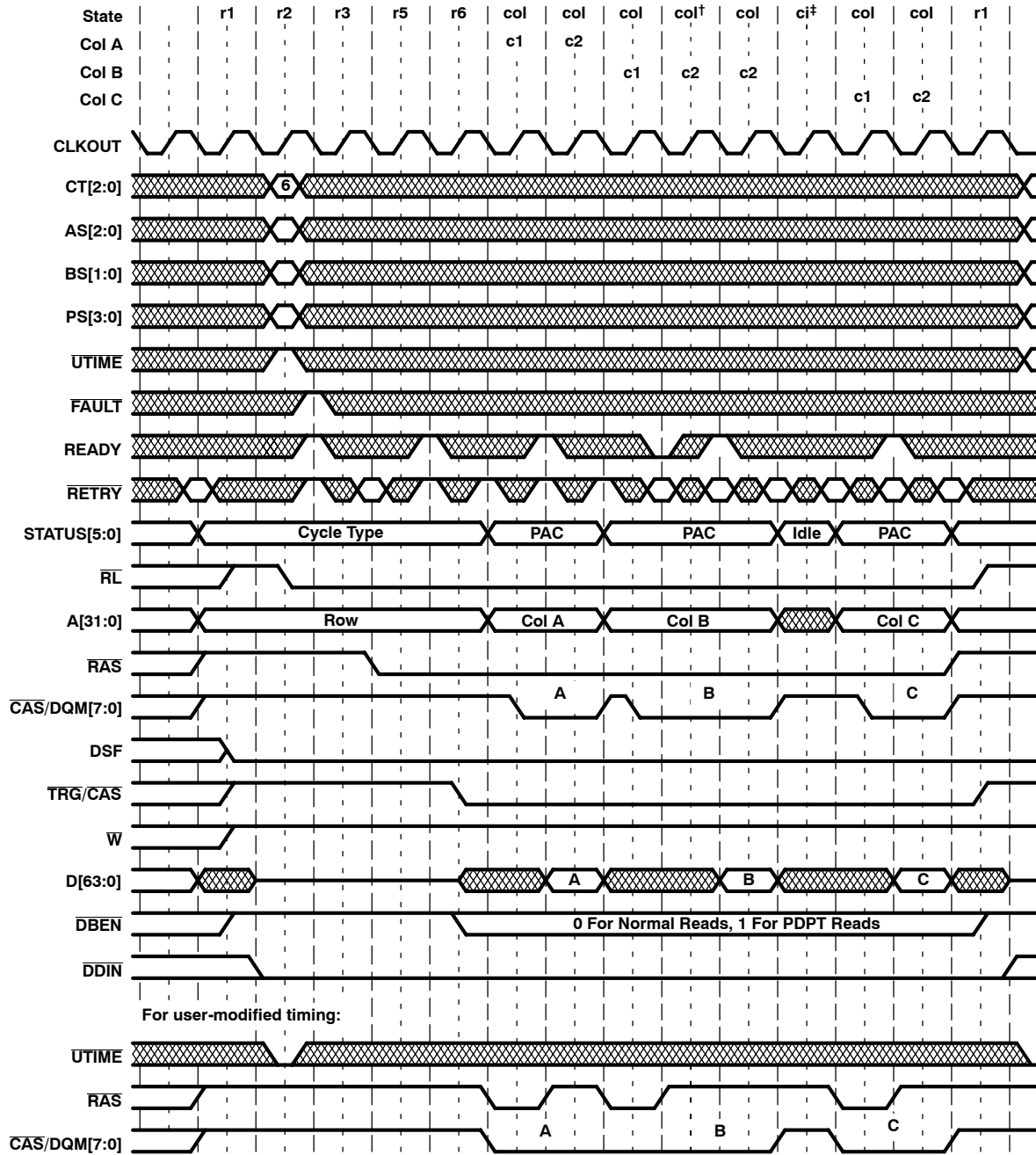

Figure 59. Nonpipelined 1-Cycle/Column Read-Cycle Timing

SMJ320C80 DIGITAL SIGNAL PROCESSOR

SGUS025B - AUGUST 1998 - REVISED JUNE 2002

read cycles (continued)



† Wait state inserted by external logic (example)

‡ Internally generated pipeline bubble (example)

Figure 60. 2-Cycle/Column Read-Cycle Timing

read cycles (continued)

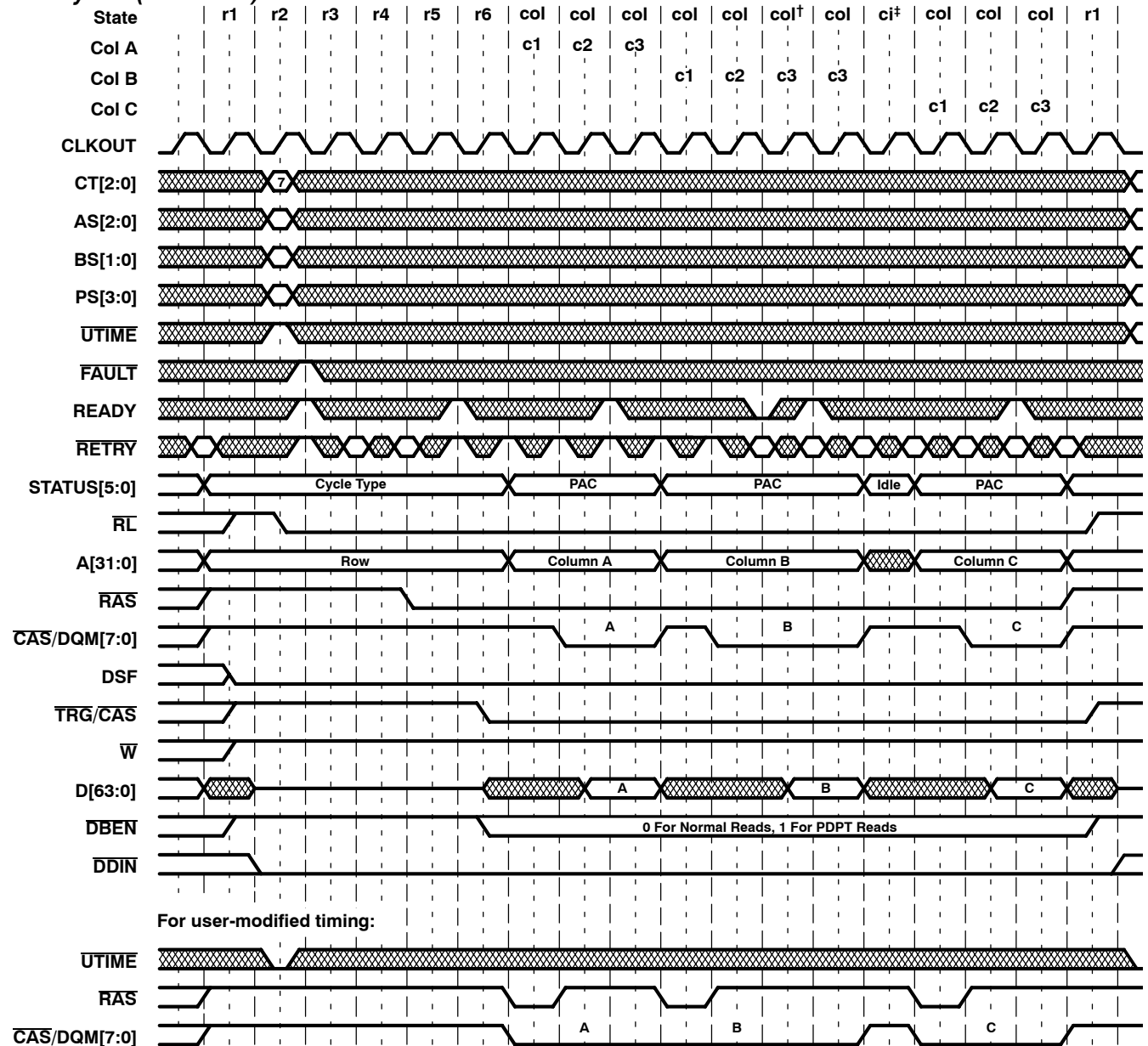

† Wait state inserted by external logic (example)
‡ Internally generated pipeline bubble (example)

Figure 61. 3-Cycle/Column Read-Cycle Timing

write cycles

Write cycles transfer data from the 'C80 to external memory. These cycles can occur as a result of a packet transfer, a DEA request, or an MP data cache write-back. During the cycle TRG/CAS is held high, W is driven low after the fall of RAS to enable early-write cycles, and DDIN is high so that data transceivers drive toward memory. The TC drives data out on D[63:0] and indicates valid bytes by activating the appropriate CAS/DQM strobes. During peripheral device packet transfers, DBEN remains high and D[63:0] is placed in high impedance so that the peripheral device can drive data into the memory.

SMJ320C80 DIGITAL SIGNAL PROCESSOR

SGUS025B - AUGUST 1998 - REVISED JUNE 2002

write cycles (continued)

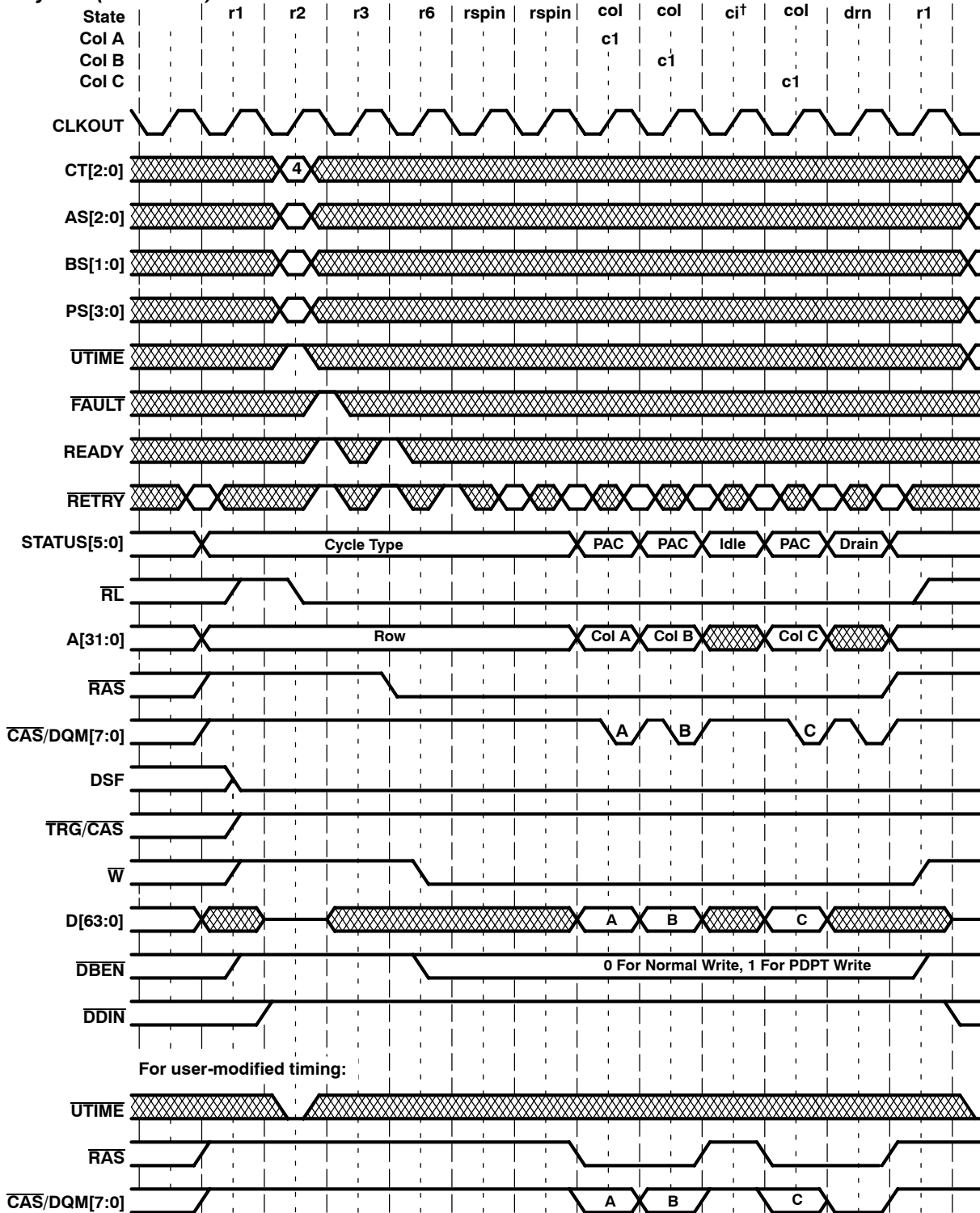

† Internally generated pipeline bubble (example)

Figure 62. Pipelined 1-Cycle/Column Write-Cycle Timing



POST OFFICE BOX 1443 • HOUSTON, TEXAS 77251-1443

write cycles (continued)

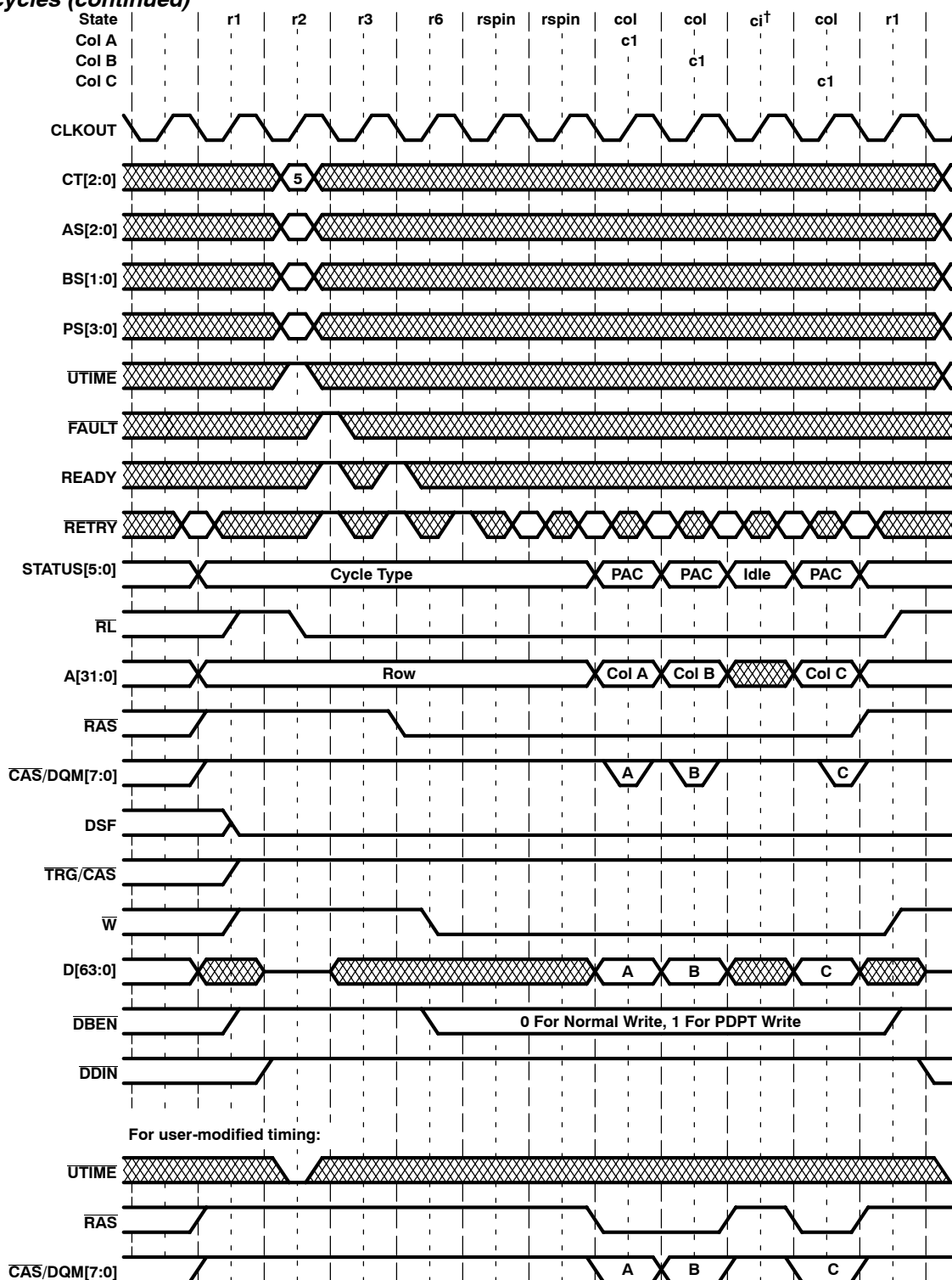

† Internally generated pipeline bubble (example)

Figure 63. Nonpipelined 1-Cycle/Column Write-Cycle Timing

SMJ320C80 DIGITAL SIGNAL PROCESSOR

SGUS025B - AUGUST 1998 - REVISED JUNE 2002

write cycles (continued)

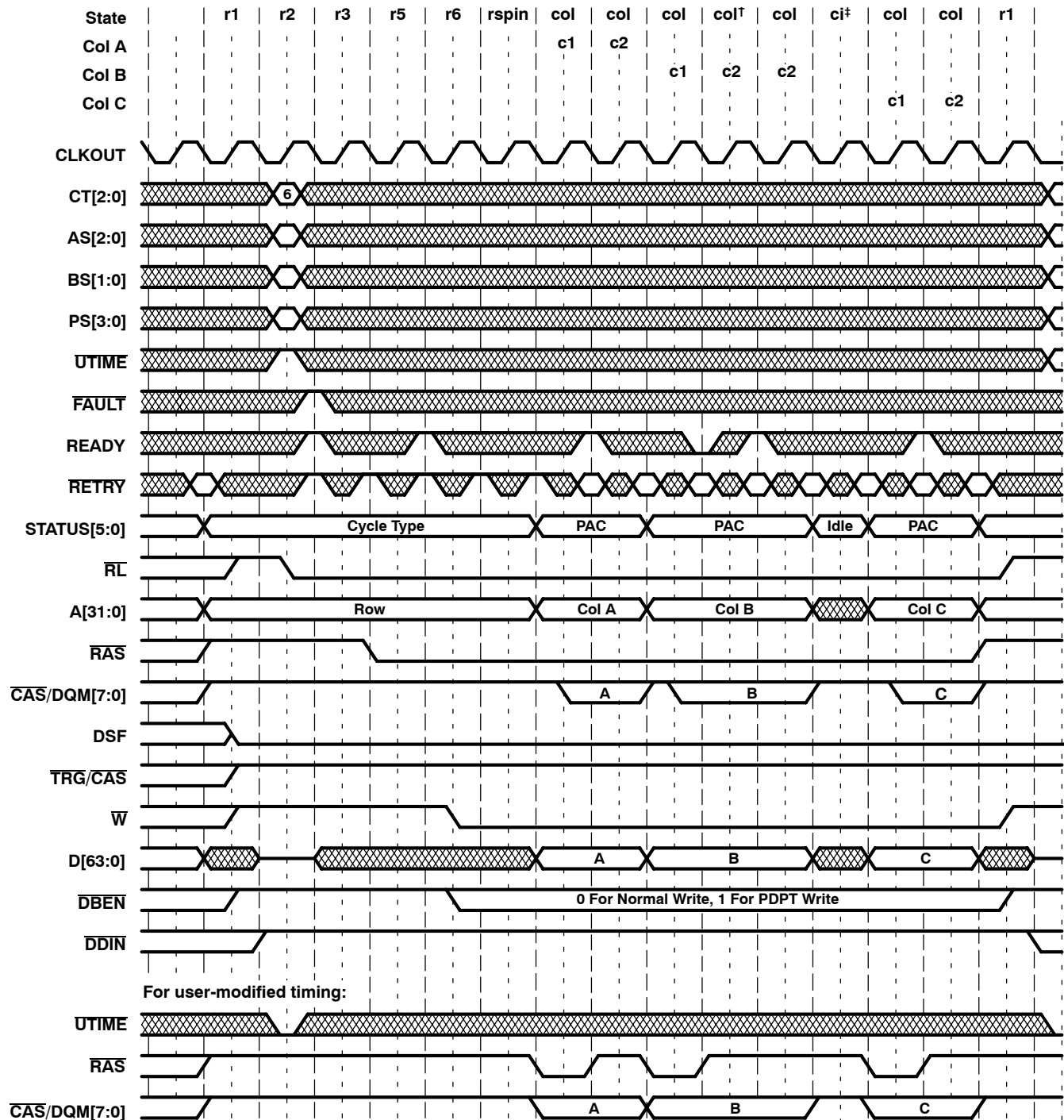

† Wait state inserted by external logic (example)
‡ Internally generated pipeline bubble (example)

Figure 64. 2-Cycle/Column Write-Cycle Timing

write cycles (continued)

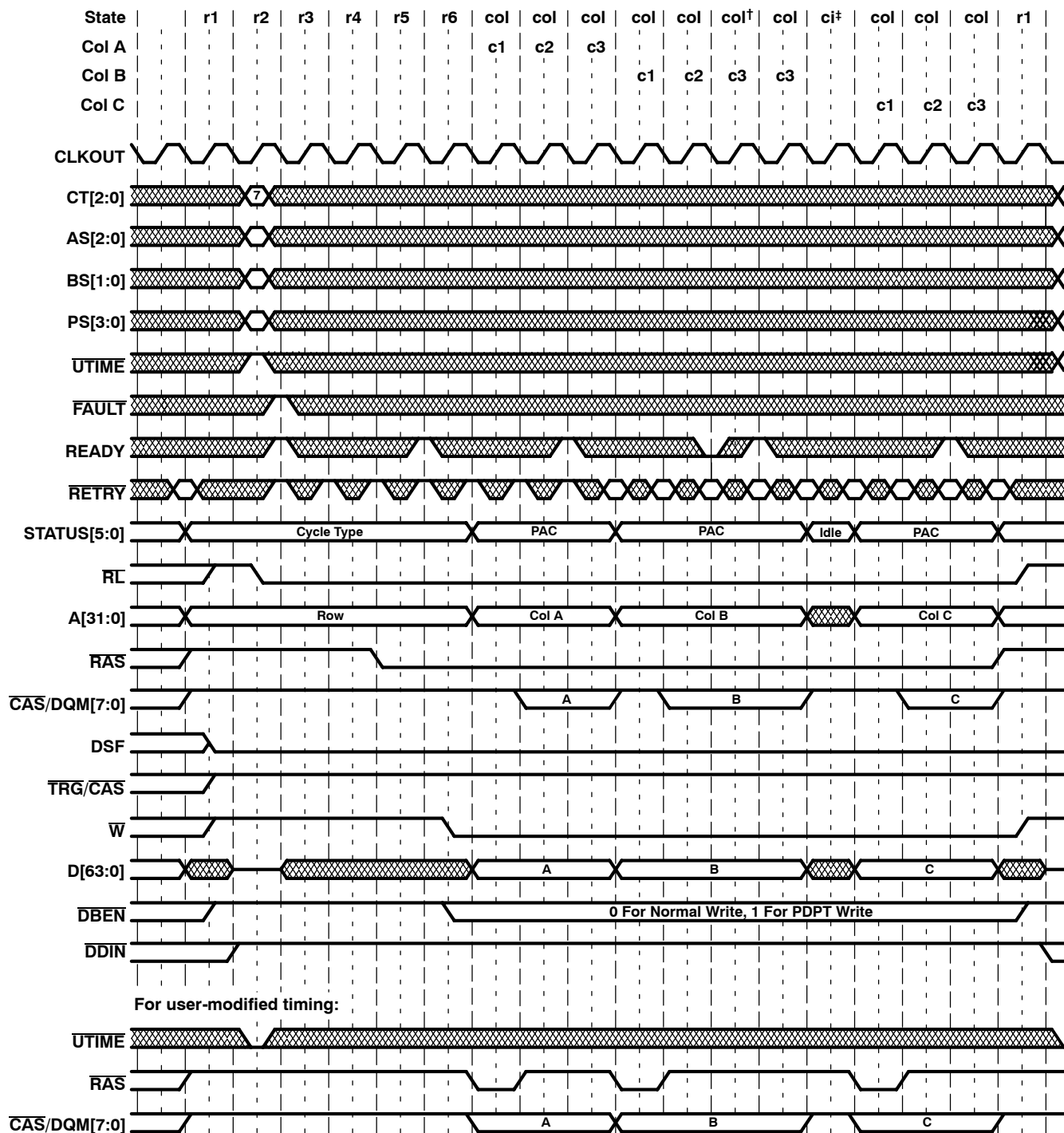

† Wait state inserted by external logic (example)
‡ Internally generated pipeline bubble (example)

Figure 65. 3-Cycle/Column Write-Cycle Timing

SMJ320C80

DIGITAL SIGNAL PROCESSOR

SGUS025B - AUGUST 1998 - REVISED JUNE 2002

load-color-register cycles

Load-color-register (LCR) cycles are used to load a VRAM's color register prior to performing a block-write. LCR cycles are supported only on 64-bit data buses. An LCR cycle closely resembles a normal write cycle because it writes into a VRAM. The difference is that the DSF output is high at both the fall of \overline{RAS} and the fall of \overline{CAS}/DQM . Also, because the VRAM color register is a single location, only one column access occurs.

The row address that is output by the TC is used for bank-decode only. Normally, all VRAM banks should be selected during an LCR cycle because another LCR cycle cannot occur when a block-write memory-page change occurs. The column address that is output during an LCR is likewise irrelevant because the VRAM color register is the only location written. All \overline{CAS}/DQM strobes are active during an LCR cycle.

If exception support for a given bank is enabled, the \overline{EXCEPT} [1:0] inputs are sampled during LCR column states and must be at valid levels. A retry code (\overline{EXCEPT} [1:0] = 10) at column time has no effect, however, because only one column access is performed.

If the BW field of the configuration cache entry for the given bank indicates that the addressed memory supports only simulated block-writes, the LCR cycle will be changed into a normal write cycle at the start of the simulated block-write.

load-color-register cycles (continued)

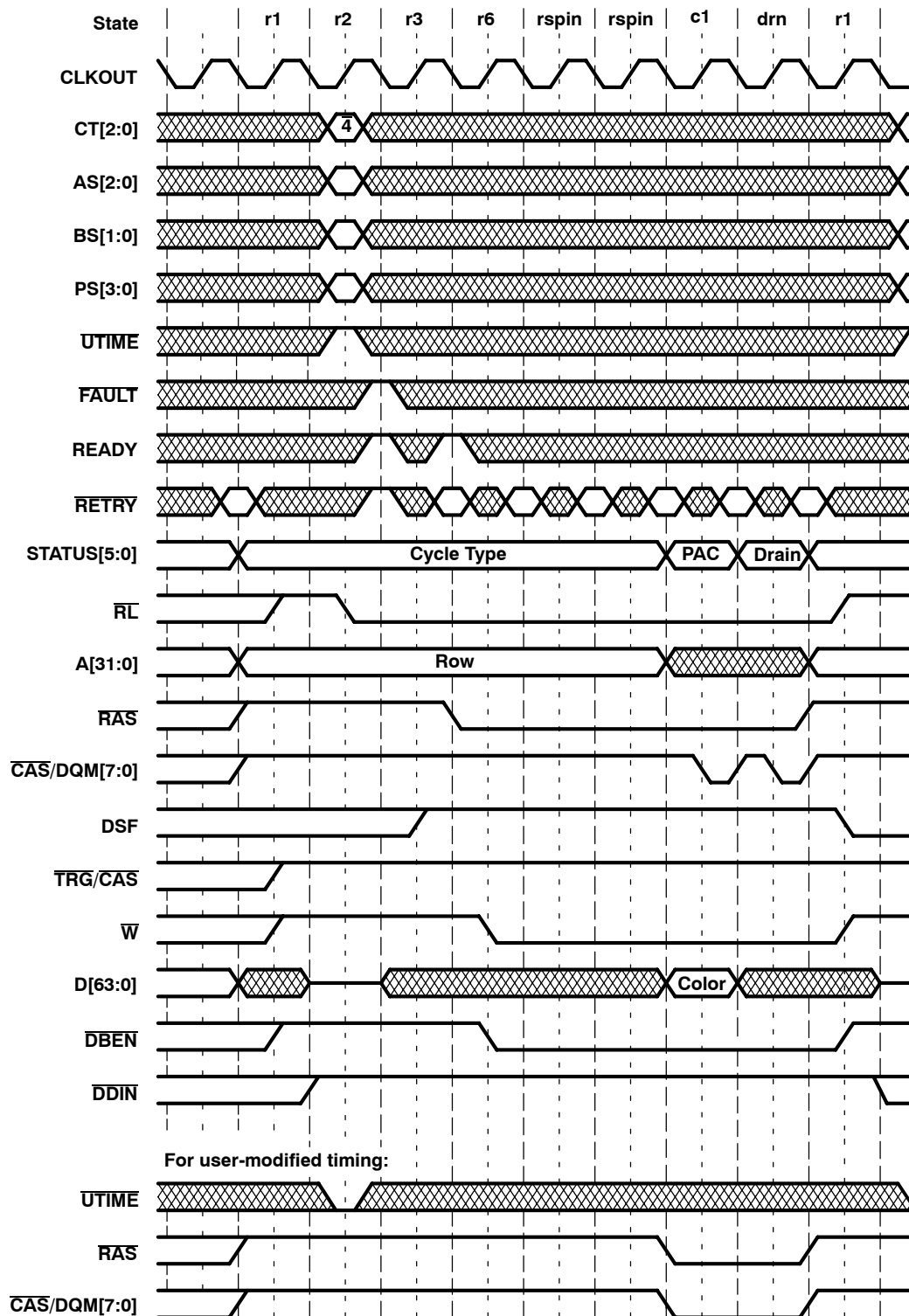

Figure 66. Pipelined 1-Cycle/Column Load-Color-Register-Cycle Timing

SMJ320C80 DIGITAL SIGNAL PROCESSOR

SGUS025B - AUGUST 1998 - REVISED JUNE 2002

load-color-register cycles (continued)

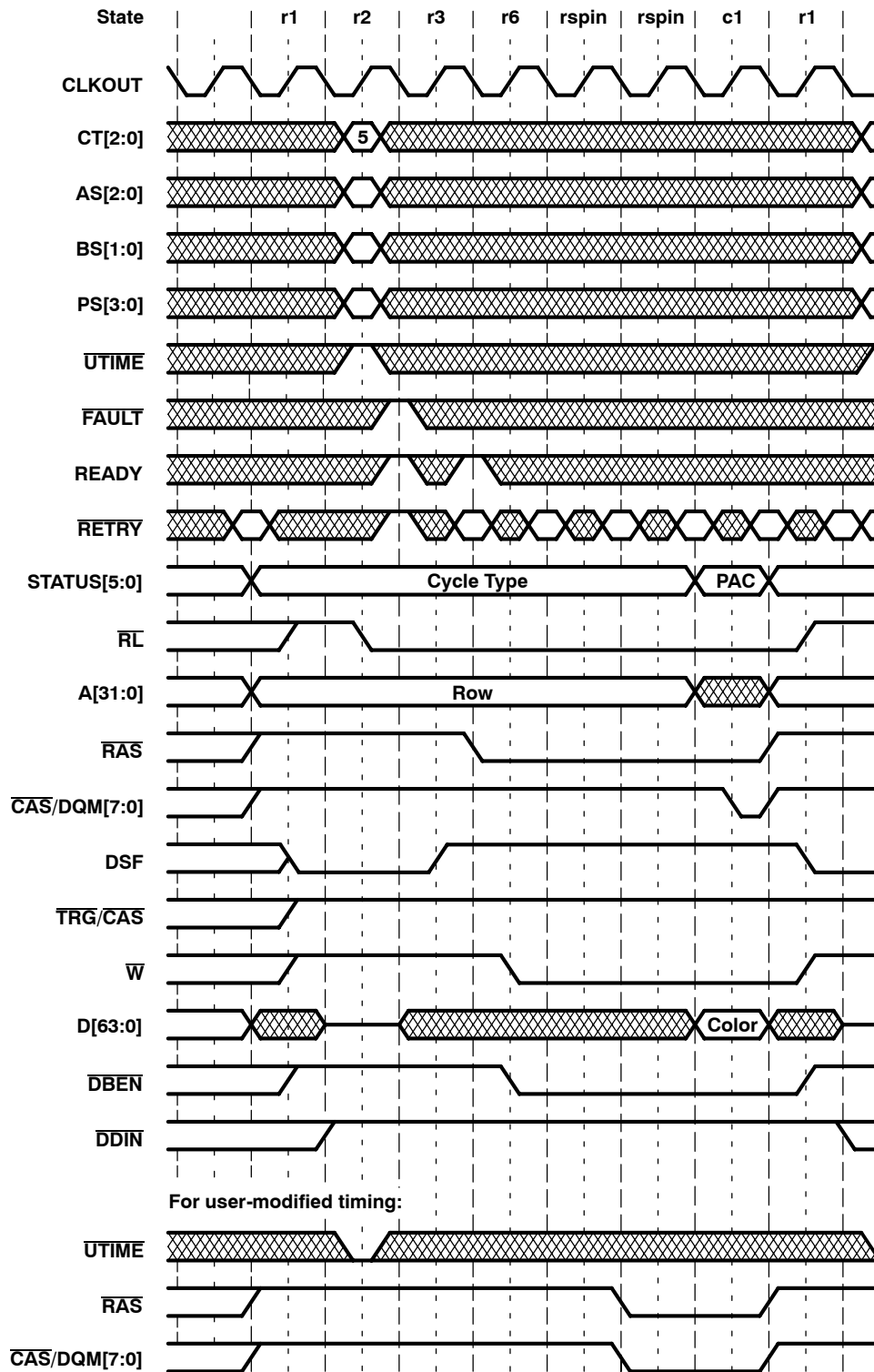

Figure 67. Nonpipelined 1-Cycle/Column Load-Color-Register-Cycle Timing

load-color-register cycles (continued)

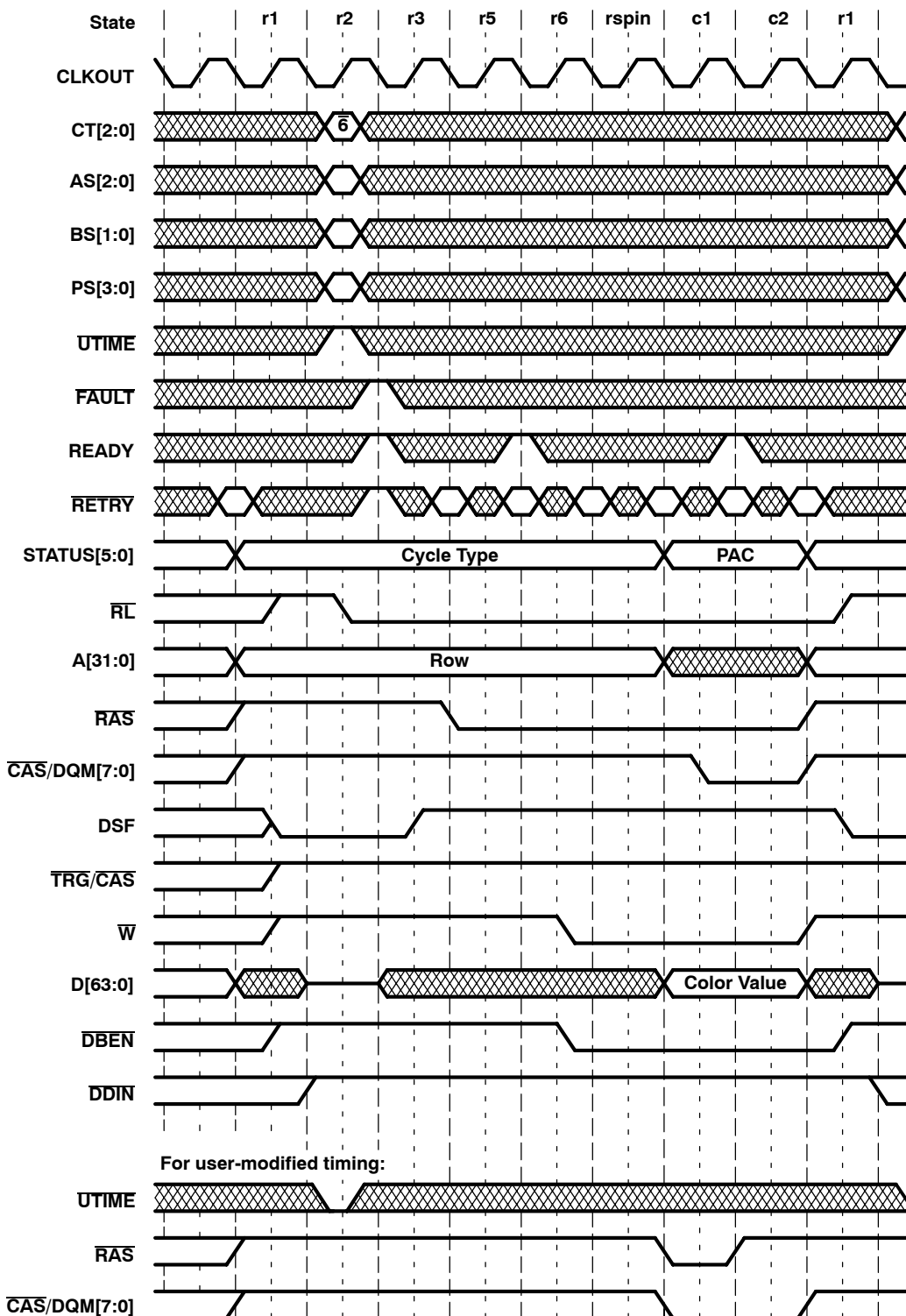

Figure 68. 2-Cycle/Column Load-Color-Register-Cycle Timing

SMJ320C80 DIGITAL SIGNAL PROCESSOR

SGUS025B - AUGUST 1998 - REVISED JUNE 2002

load-color-register cycles (continued)

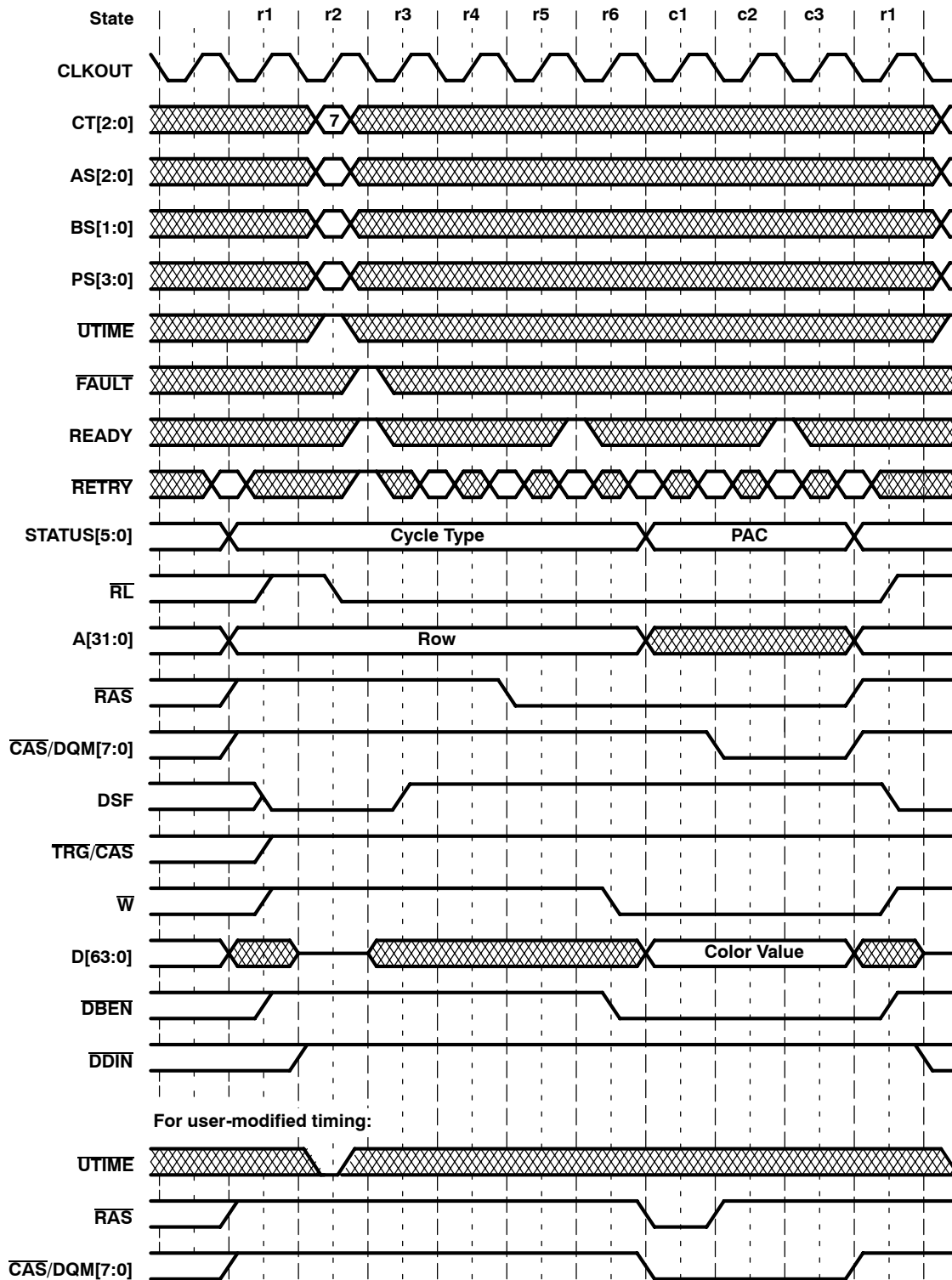

Figure 69. 3-Cycle/Column Load-Color-Register-Cycle Timing

block-write cycles

Block-write cycles cause the data stored in the VRAM color registers to be written to the memory locations enabled by the appropriate data bits output on the D[63:0] bus. This allows up to a total of 64 bytes (depending on the type of block-write being used) to be written in a single-column access. This cycle is identical to a standard write cycle with the following exceptions:

- DSF is active (high) at the fall of $\overline{\text{CAS}}$, enabling the block-write function within the VRAMs.
- Only 64-bit bus sizes are supported during block-write; therefore, BS[1:0] inputs are used to indicate the type of block-write that is supported by the addressed VRAMs, rather than the bus size.
- The two or three LSBs (depending on the type of block-write) of the column address are ignored by the VRAMs because these column locations are specified by the data inputs.
- The values output by the TC on D[63:0] represent the column locations to be written to, using the color register value. Depending on the type of block-write supported by the VRAM, all of the data bits are not necessarily used by the VRAMs.
- Block-writes always begin with a row access. Upon completion of a block-write, the memory interface returns to state r1 to await the next access.

SMJ320C80 DIGITAL SIGNAL PROCESSOR

SGUS025B - AUGUST 1998 - REVISED JUNE 2002

block-write cycles (continued)

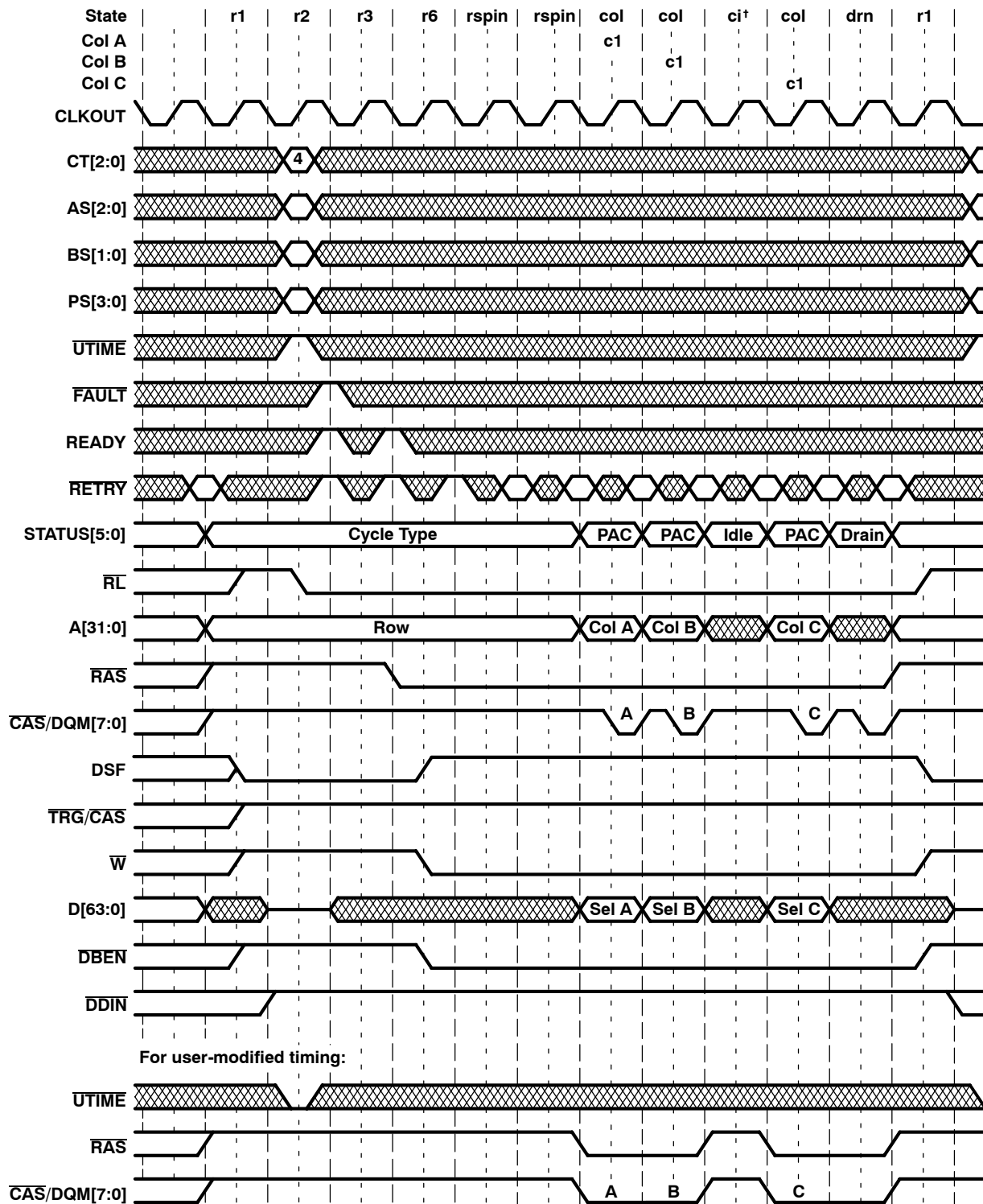

† Internally generated pipeline bubble (example)

Figure 70. Pipelined 1-Cycle/Column Block-Write-Cycle Timing

block-write cycles (continued)

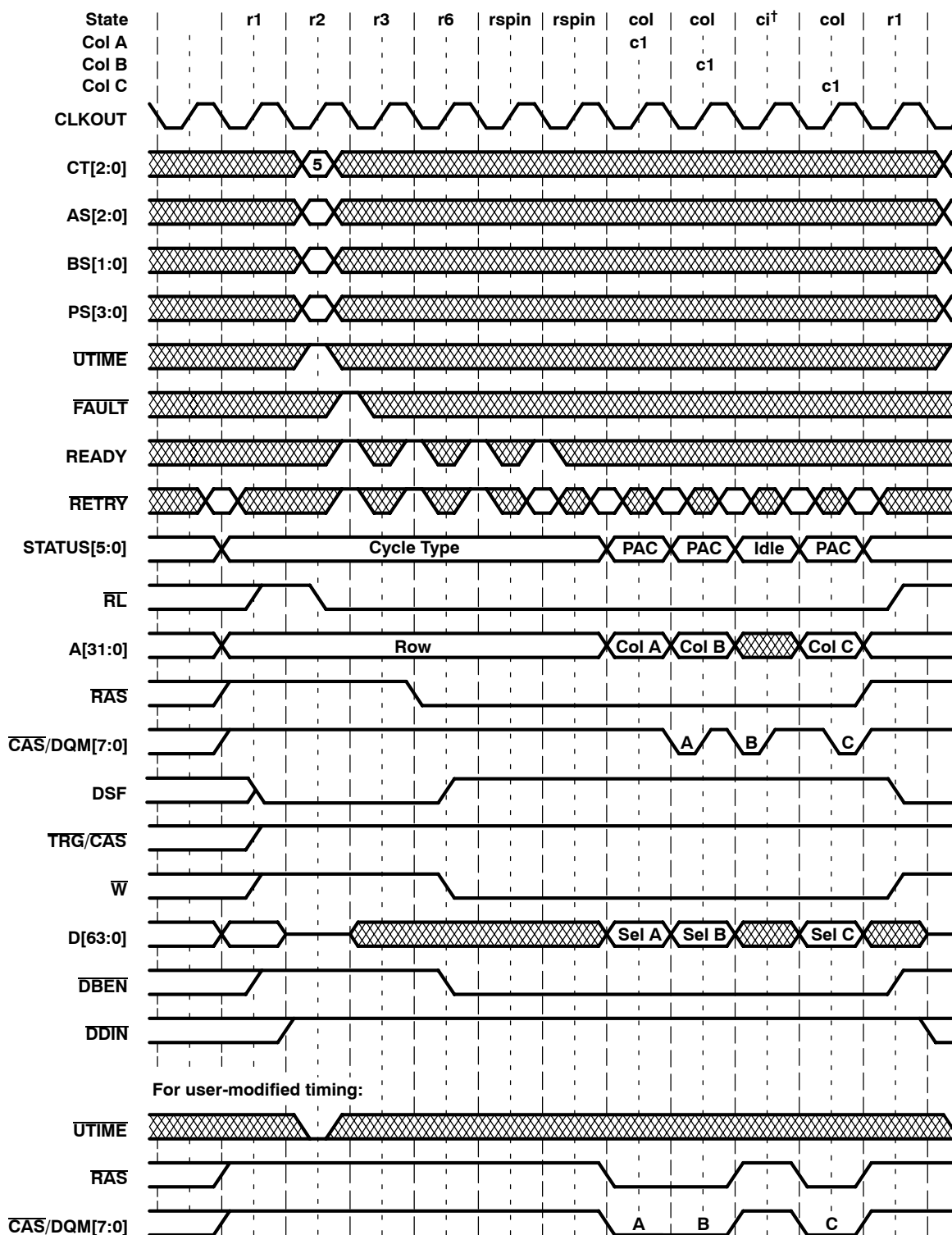

† Internally generated pipeline bubble (example)

Figure 71. Nonpipelined 1-Cycle/Column Block-Write-Cycle Timing

SMJ320C80 DIGITAL SIGNAL PROCESSOR

SGUS025B - AUGUST 1998 - REVISED JUNE 2002

block-write cycles (continued)

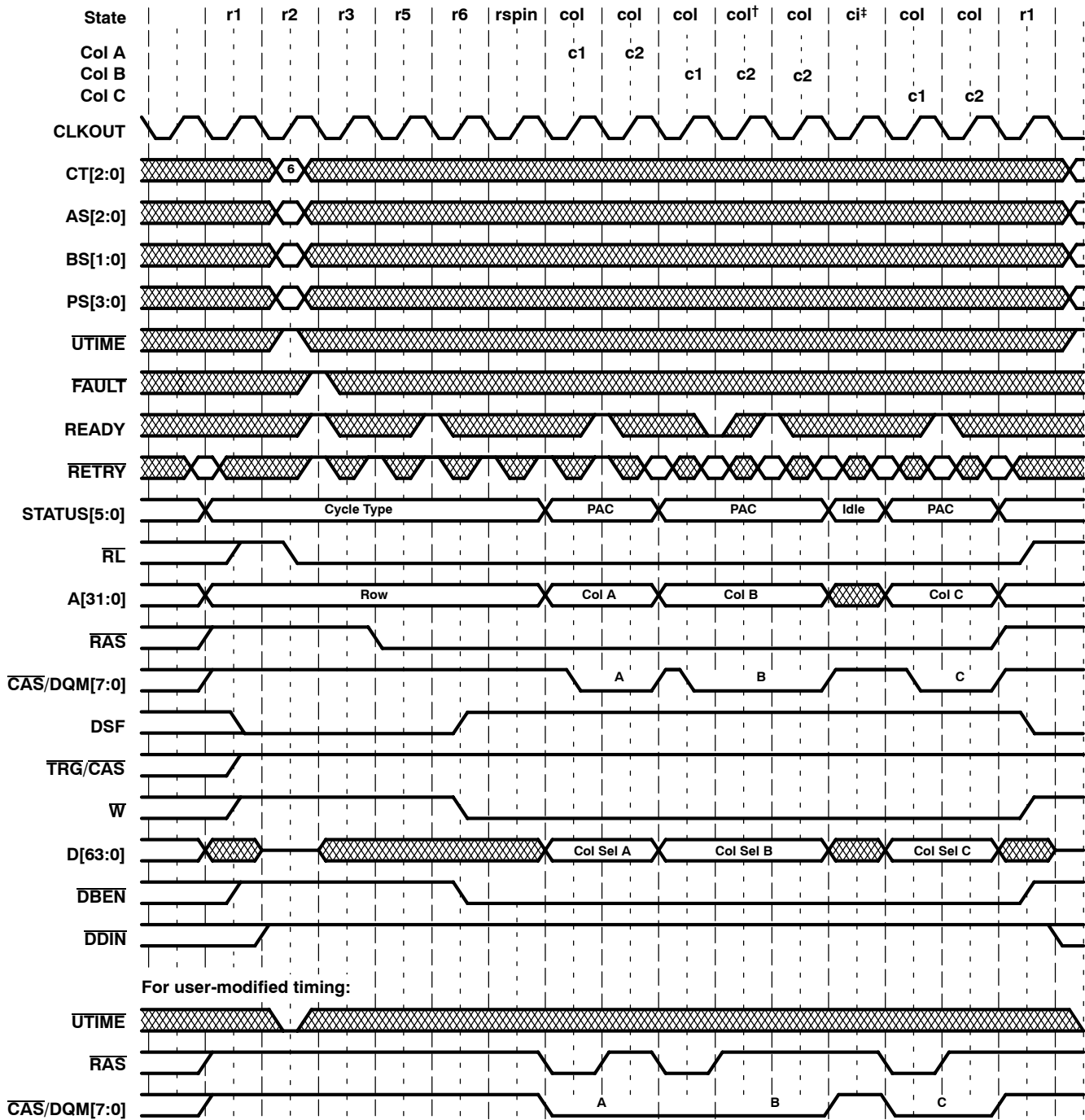

† Wait state inserted by external logic (example)

‡ Internally generated pipeline bubble (example)

Figure 72. 2-Cycle/Column Block-Write-Cycle Timing

block-write cycles (continued)

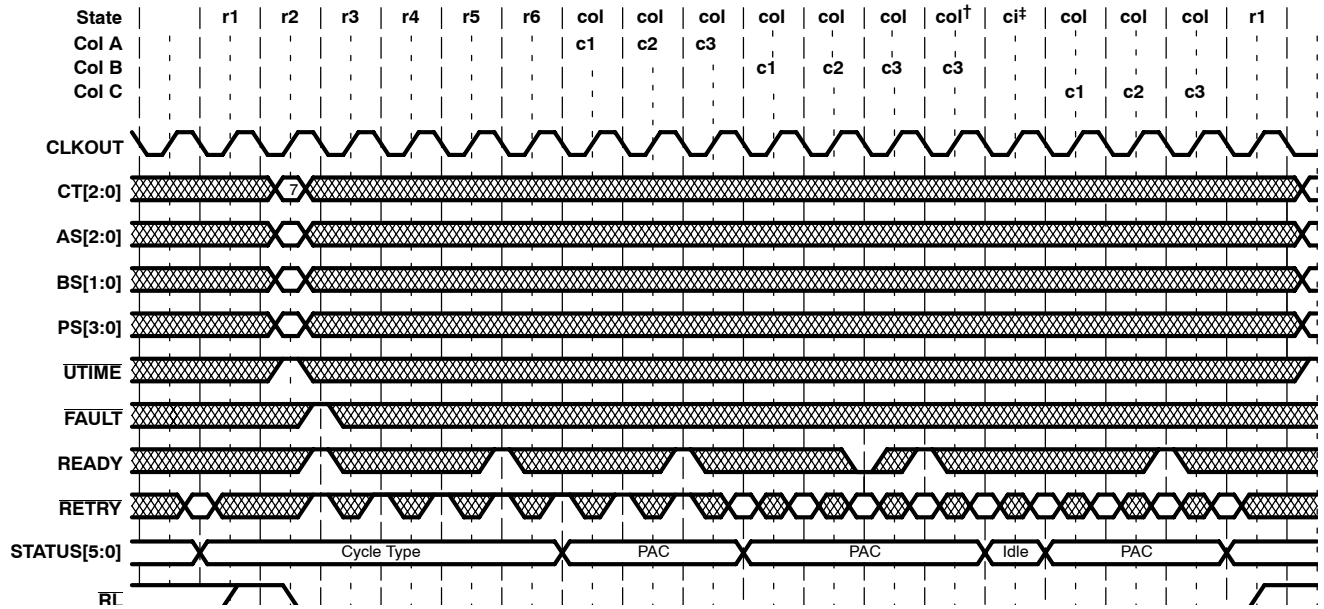

† Wait state inserted by external logic (example)
‡ Internally generated pipeline bubble (example)

Figure 73. 3-Cycle/Column Block-Write-Cycle Timing

SMJ320C80

DIGITAL SIGNAL PROCESSOR

SGUS025B - AUGUST 1998 - REVISED JUNE 2002

transfer cycles

Read-transfer (memory-to-register) cycles transfer a row from the VRAM memory array into the VRAM shift register (sequential-access memory, or SAM). This causes the entire SAM (both halves of the split SAM) to be loaded with the array data.

Split-register read-transfer (memory-to-split-register) cycles also transfer data from a row in the memory array to the SAM. However, these transfers cause only half of the SAM to be written. Split-register read transfers allow the inactive half of the SAM to be loaded with the new data while the other active half continues to shift data in or out.

Write-transfer (register-to-memory) cycles transfer data from the SAM into a row of the VRAM array. This transfer causes the entire SAM (both halves of the split SAM) to be written into the array.

Split-register write-transfer (split-register-to-memory) cycles also transfer data from the SAM to a row in the memory array. However, these transfers write only half of the SAM into the array. Split-register write transfers allow the inactive half of the SAM to be transferred into memory while the other (active) half continues to shift serial data in or out.

Read and split-read transfers resemble a standard read cycle. Write and split-write transfers resemble a standard write cycle. The $\overline{\text{TRG/CAS}}$ output is driven low prior to the fall of $\overline{\text{RAS}}$ to indicate a transfer cycle. Only a single column access is performed so $\overline{\text{RETRY}}$, while required to be at a valid level, has no effect if asserted at column time. The value output on A[31:0] at column time represents the SAM tap point.



transfer cycles (continued)

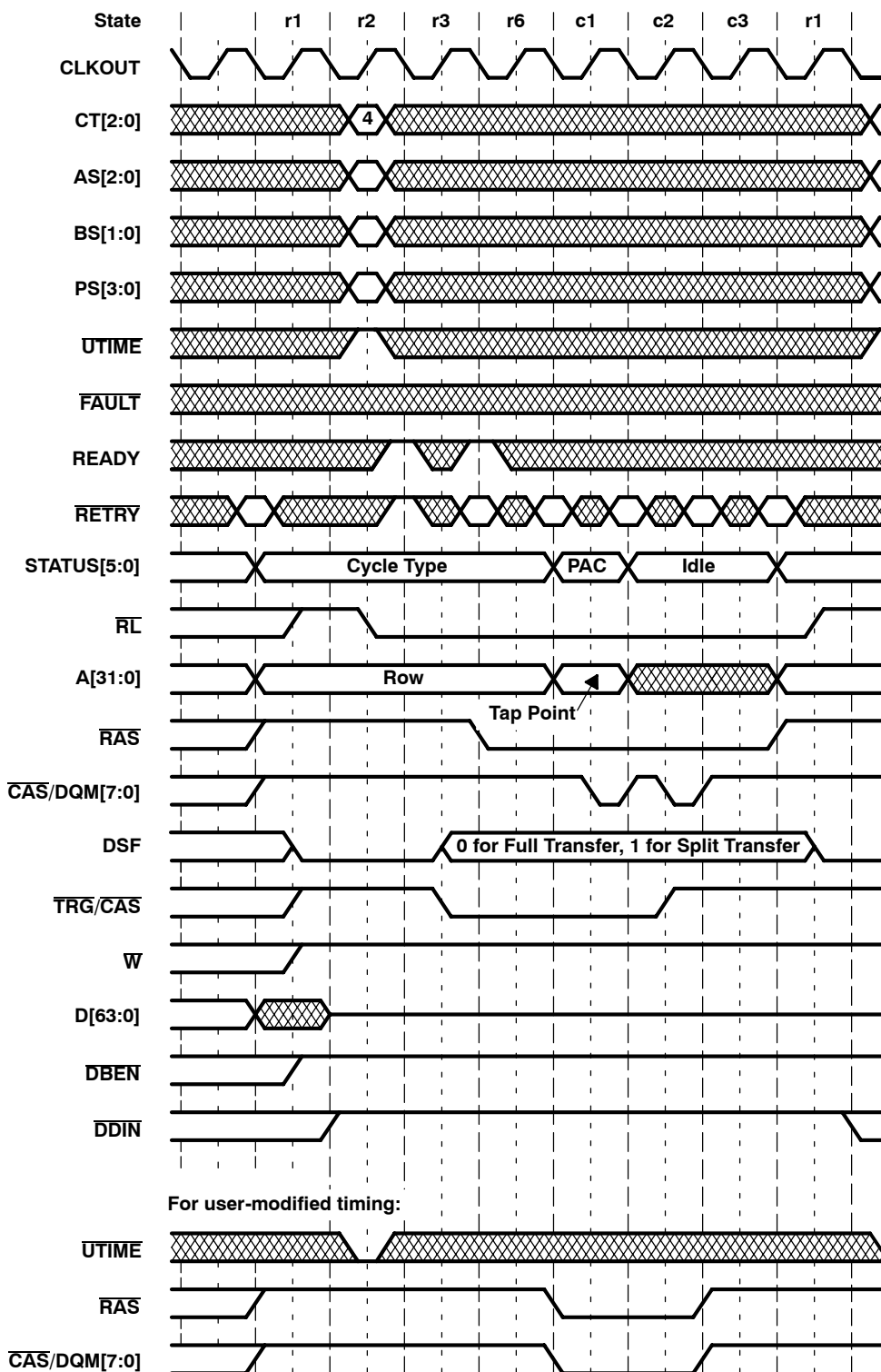

Figure 74. Pipelined 1-Cycle/Column Read-Transfer and Split-Register Read-Transfer-Cycle Timing

SMJ320C80 DIGITAL SIGNAL PROCESSOR

SGUS025B - AUGUST 1998 - REVISED JUNE 2002

transfer cycles (continued)

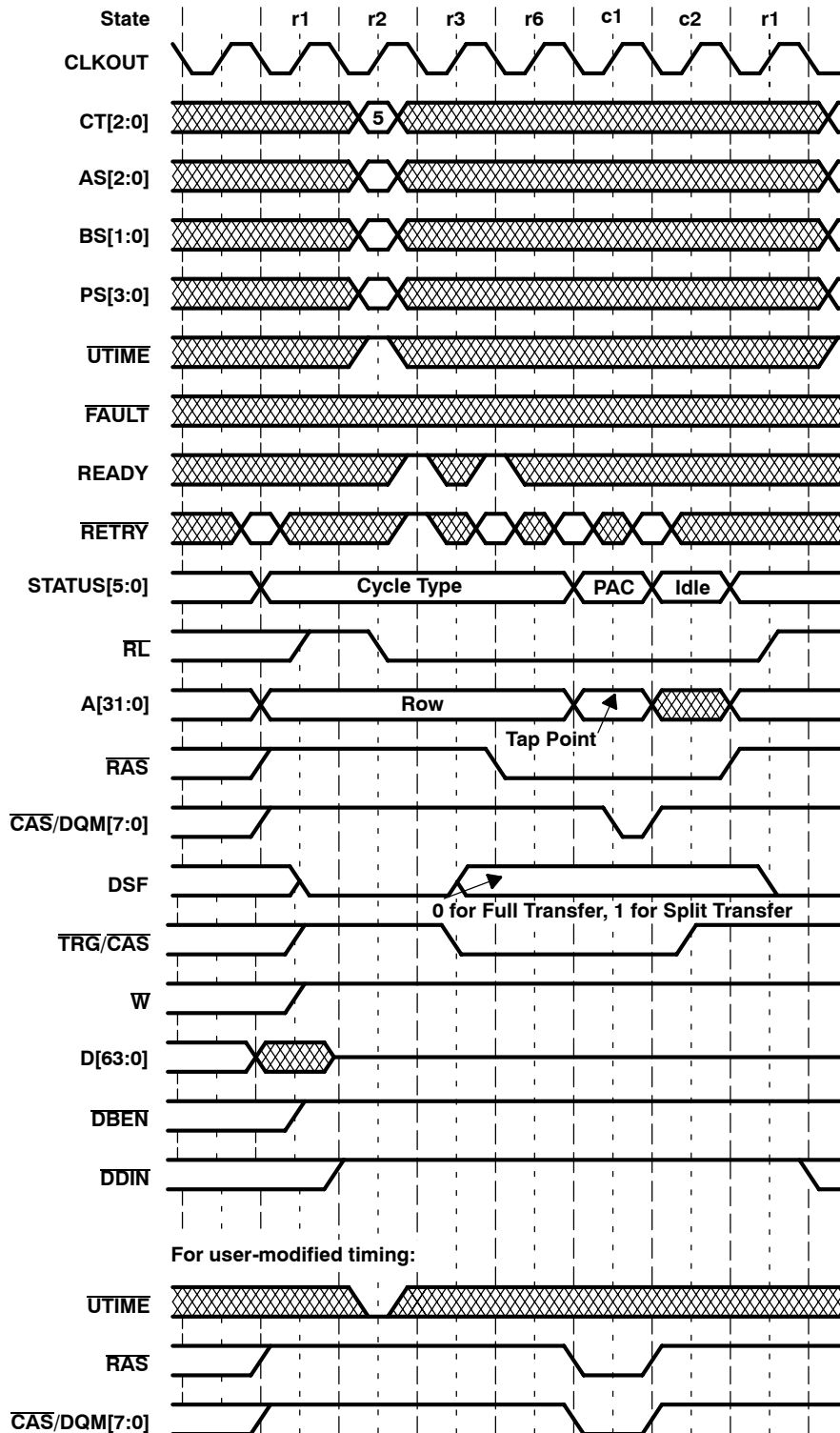

Figure 75. Nonpipelined 1-Cycle/Column Read-Transfer and Split-Register Read-Transfer-Cycle Timing

transfer cycles (continued)

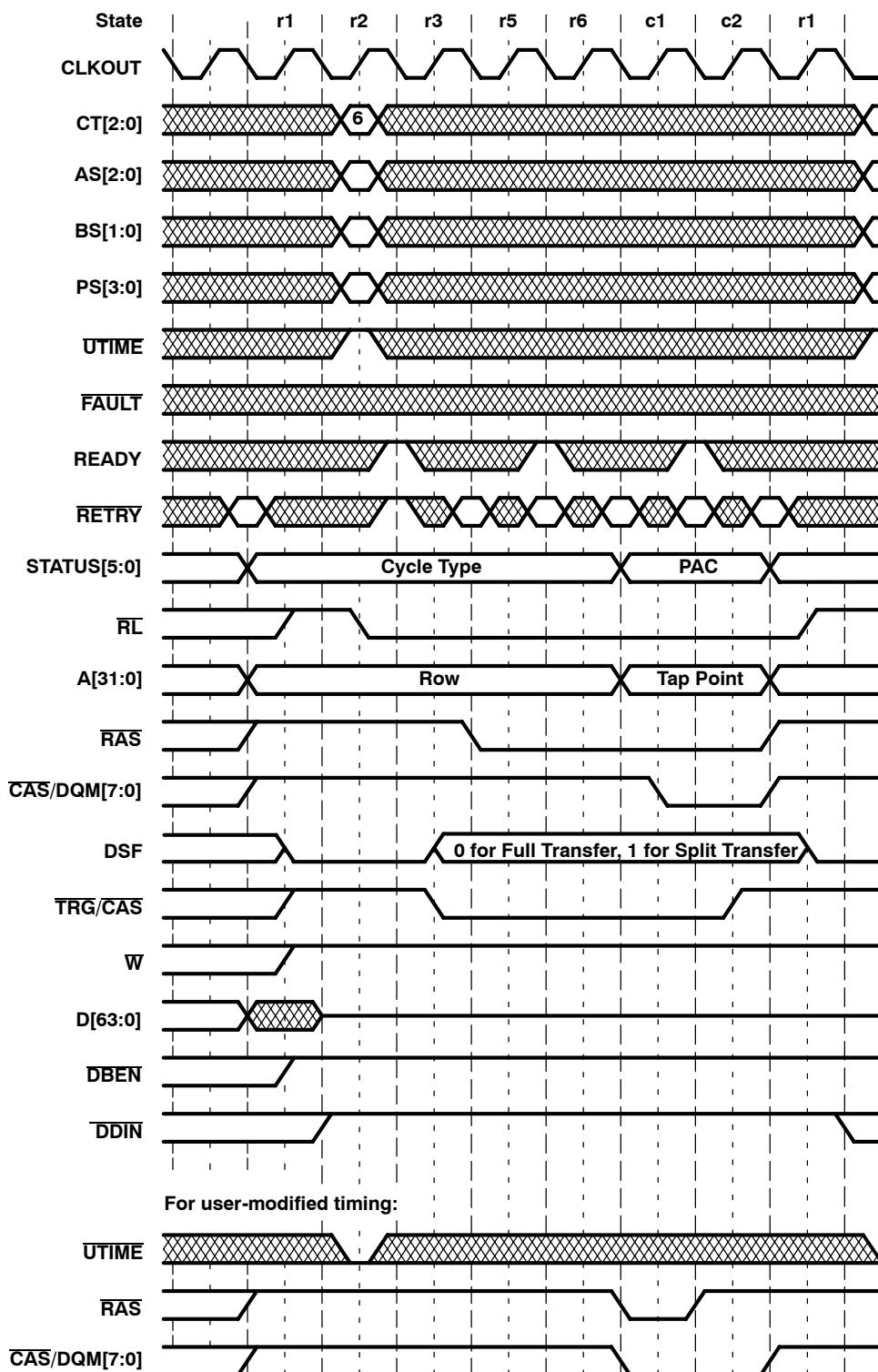

Figure 76. 2-Cycle/Column Read-Transfer and Split-Register Read-Transfer-Cycle Timing

SMJ320C80 DIGITAL SIGNAL PROCESSOR

SGUS025B - AUGUST 1998 - REVISED JUNE 2002

transfer cycles (continued)

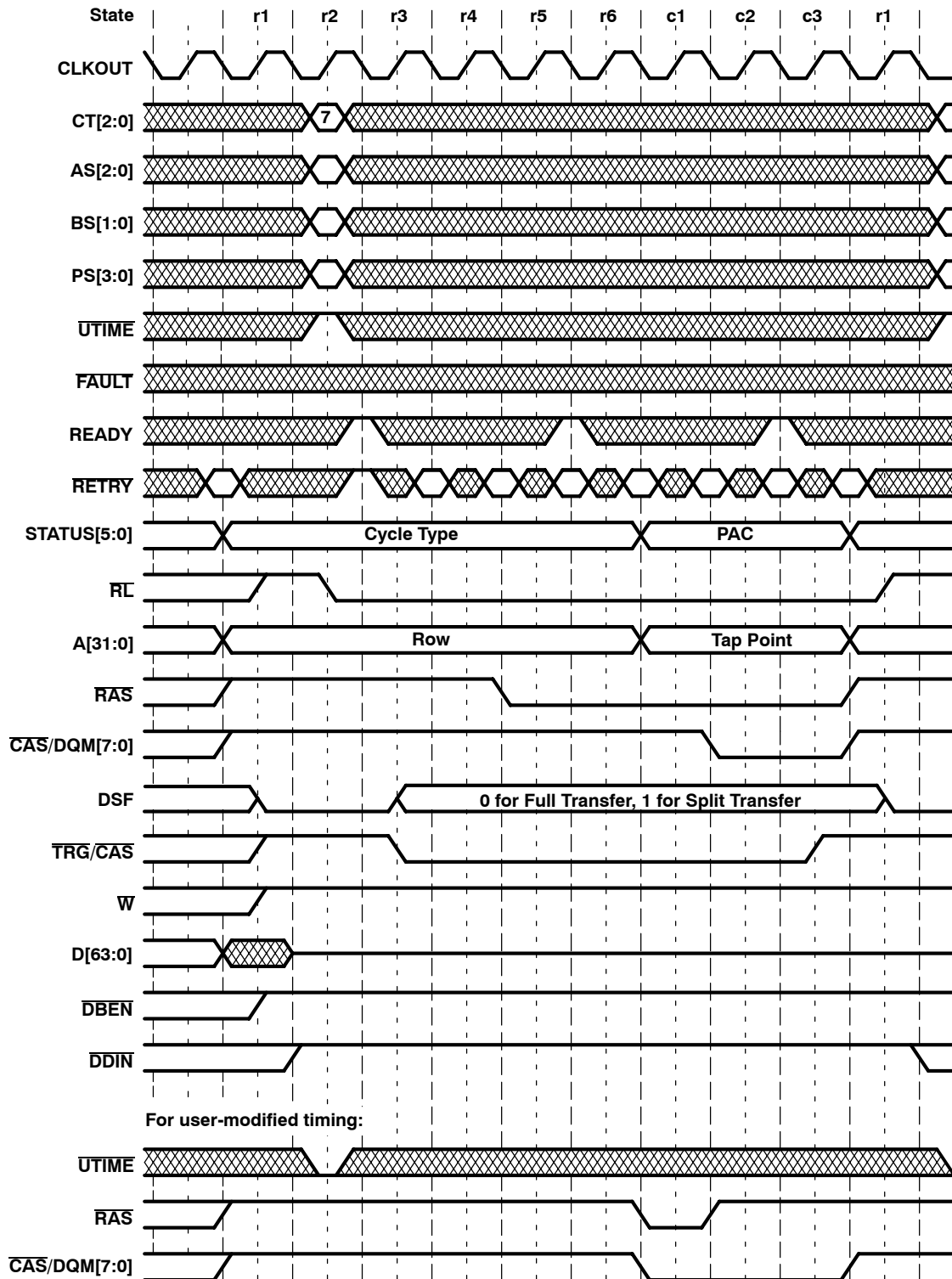

Figure 77. 3-Cycle/Column Read-Transfer and Split-Register Read-Transfer-Cycle Timing

transfer cycles (continued)

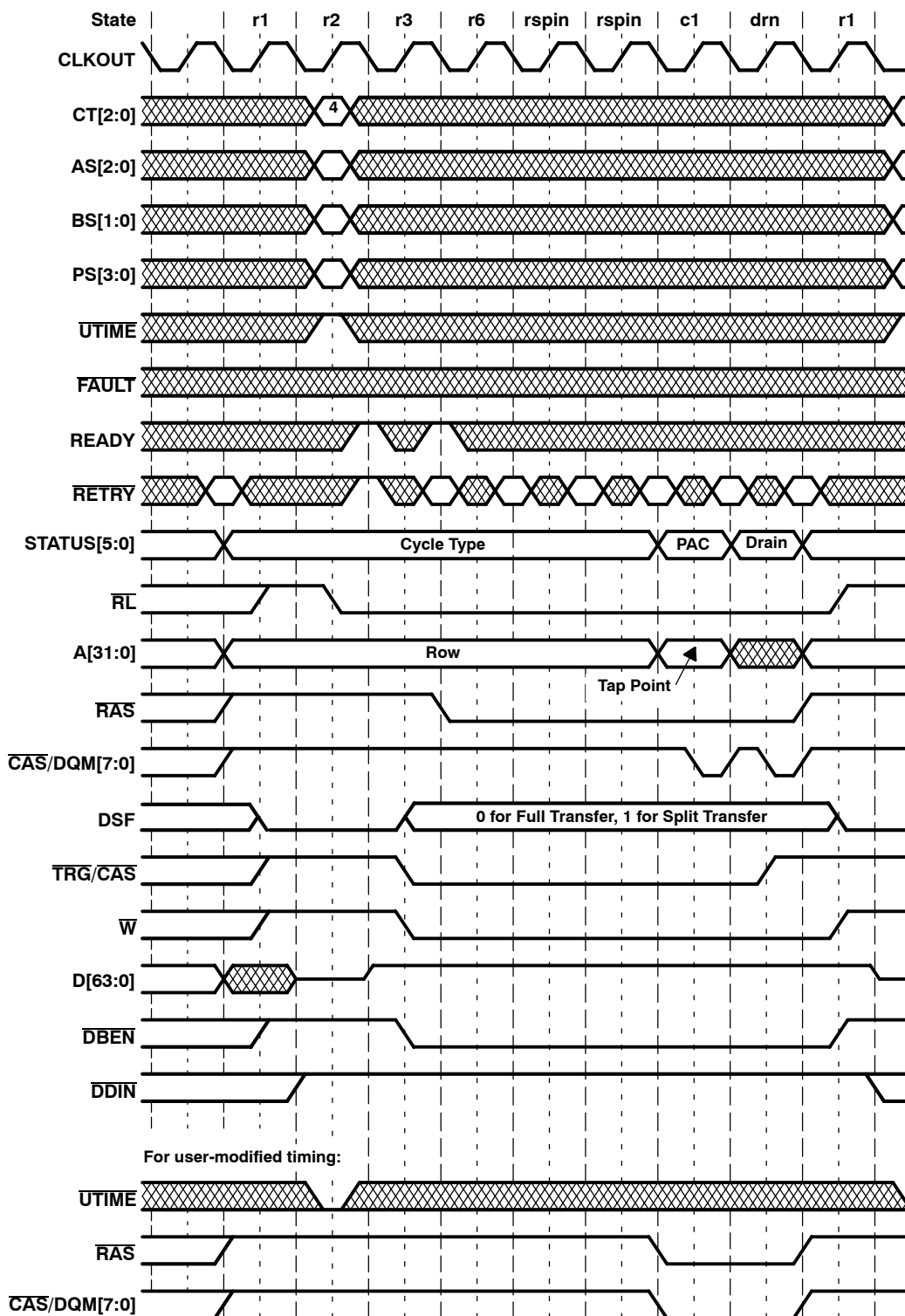

Figure 78. Pipelined 1-Cycle/Column Write-Transfer and Split-Register Write-Transfer-Cycle Timing

SMJ320C80 DIGITAL SIGNAL PROCESSOR

SGUS025B - AUGUST 1998 - REVISED JUNE 2002

transfer cycles (continued)

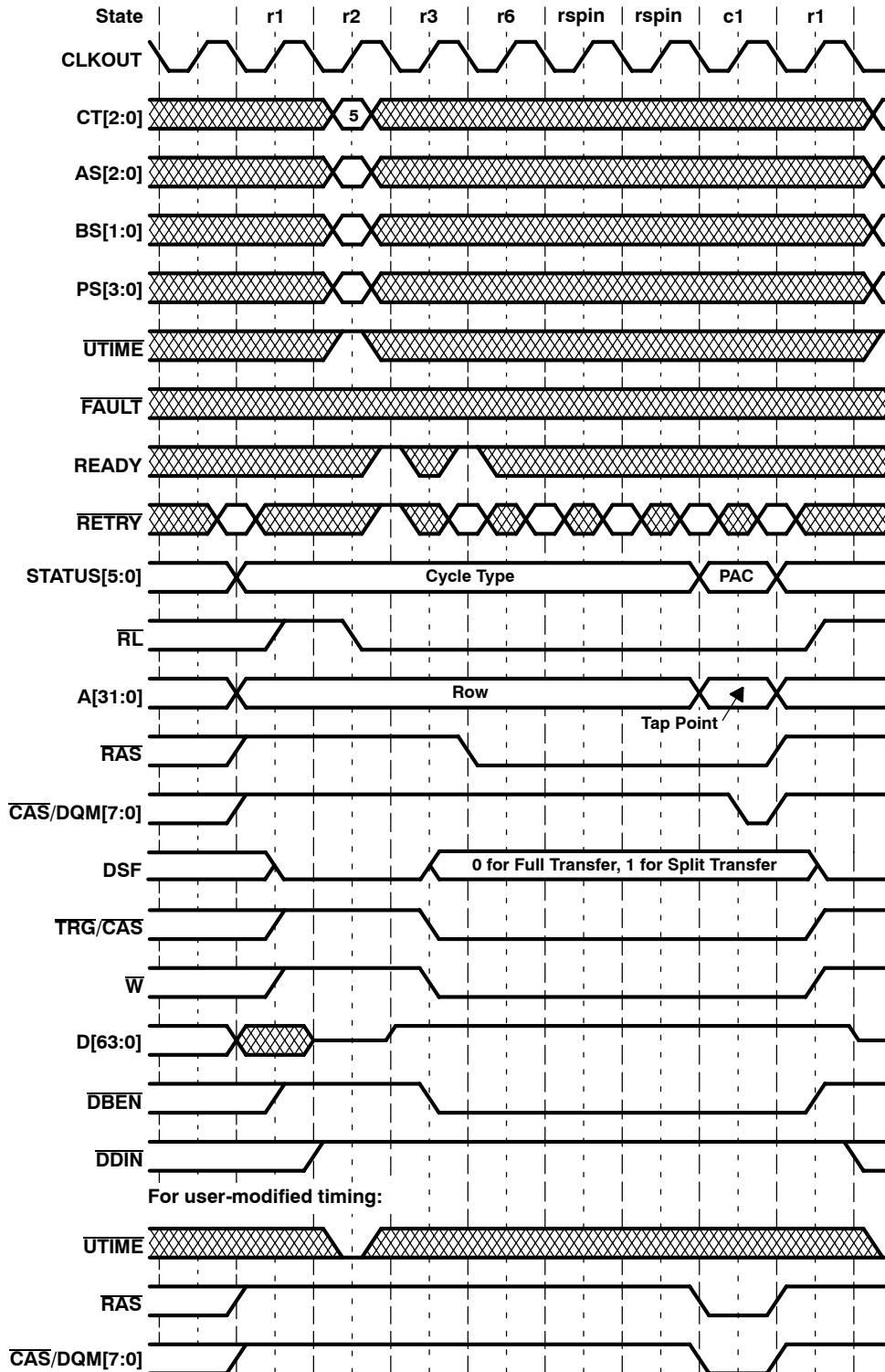

Figure 79. Nonpipelined 1-Cycle/Column Write-Transfer and Split-Register Write-Transfer-Cycle Timing

transfer cycles (continued)

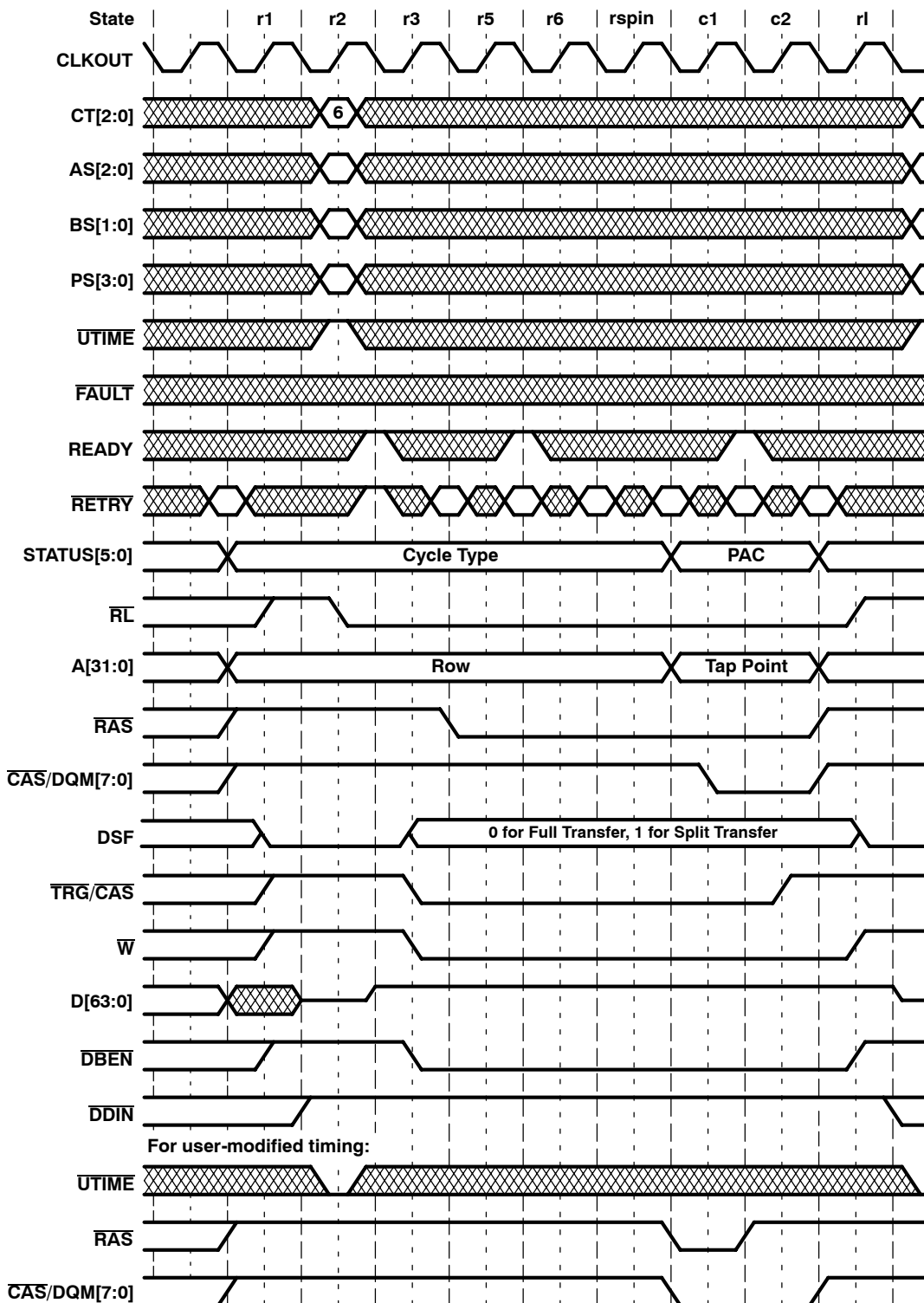

Figure 80. 2-Cycle/Column Write-Transfer and Split-Register Write-Transfer-Cycle Timing

SMJ320C80 DIGITAL SIGNAL PROCESSOR

SGUS025B - AUGUST 1998 - REVISED JUNE 2002

transfer cycles (continued)

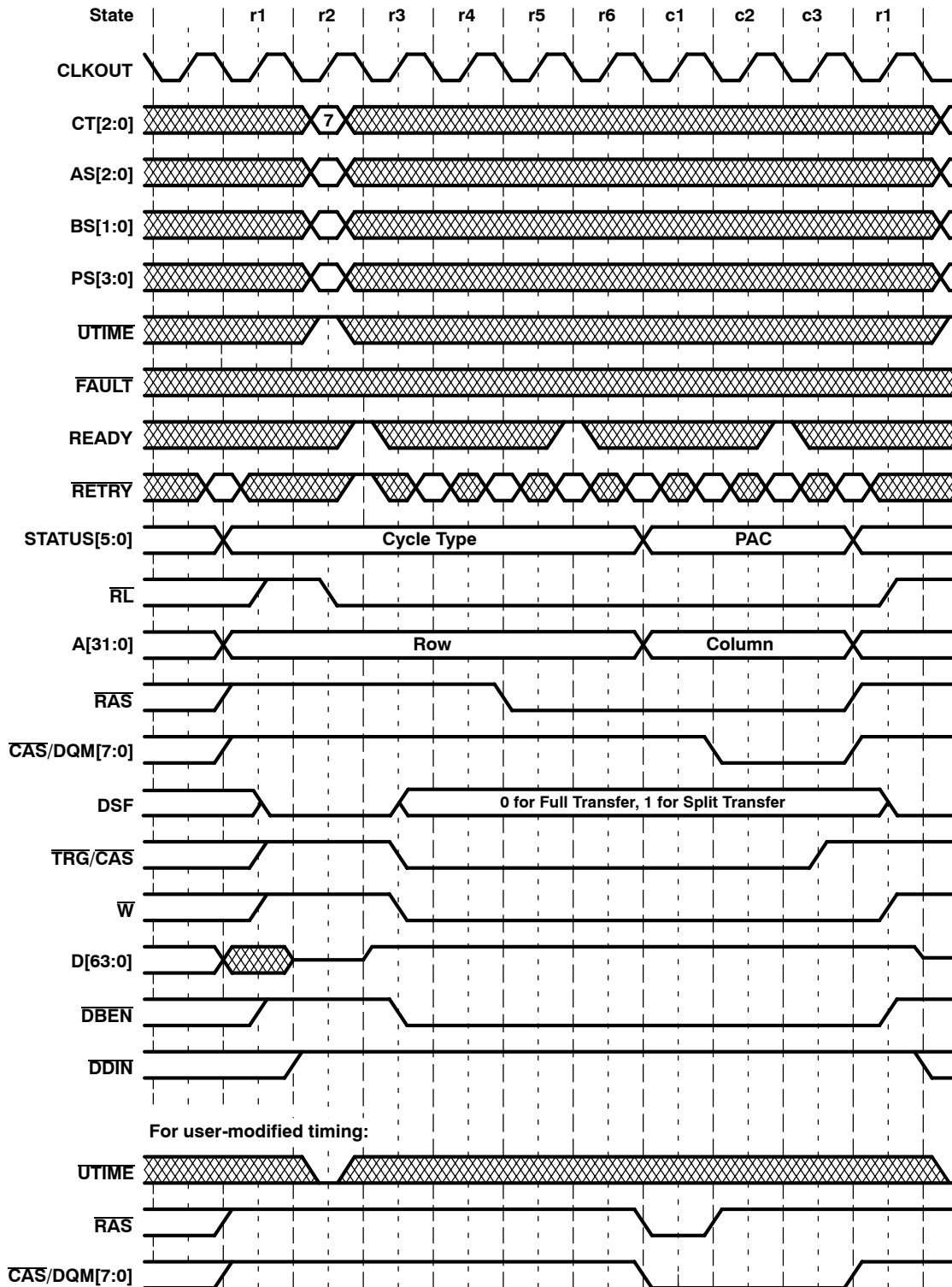

Figure 81. 3-Cycle/Column Write-Transfer and Split-Register Write-Transfer-Cycle Timing

refresh cycles

Refresh cycles are generated by the TC at the programmed refresh interval. They are characterized by the following signal activity:

- $\overline{\text{CAS}}$ falls prior to $\overline{\text{RAS}}$.
- All $\overline{\text{CAS}}$ pins ($\overline{\text{CAS}}[7:0]$) are active.
- $\overline{\text{TRG}}$, $\overline{\text{W}}$, and $\overline{\text{DBEN}}$ all remain inactive (high) because no data transfer occurs.
- DSF is active (high) at the fall of $\overline{\text{CAS}}$ and is driven inactive prior to the fall of $\overline{\text{RAS}}$.
- The data bus is driven to the high-impedance state.
- The upper half of the address bus (A[31:16]) contains the refresh pseudo-address and the lower half (A[15:0]) is driven to all zeros.
- If $\overline{\text{RETRY}}$ is asserted at any sample point during the cycle, the cycle timing is not modified. Instead, the pseudo-address and backlog counters are simply not decremented.
- Selecting user-modified timing has no effect on the cycles.
- Upon completion of the refresh cycle, the memory interface returns to state r1 to await the next access.

SMJ320C80 DIGITAL SIGNAL PROCESSOR

SGUS025B - AUGUST 1998 - REVISED JUNE 2002

refresh cycles (continued)

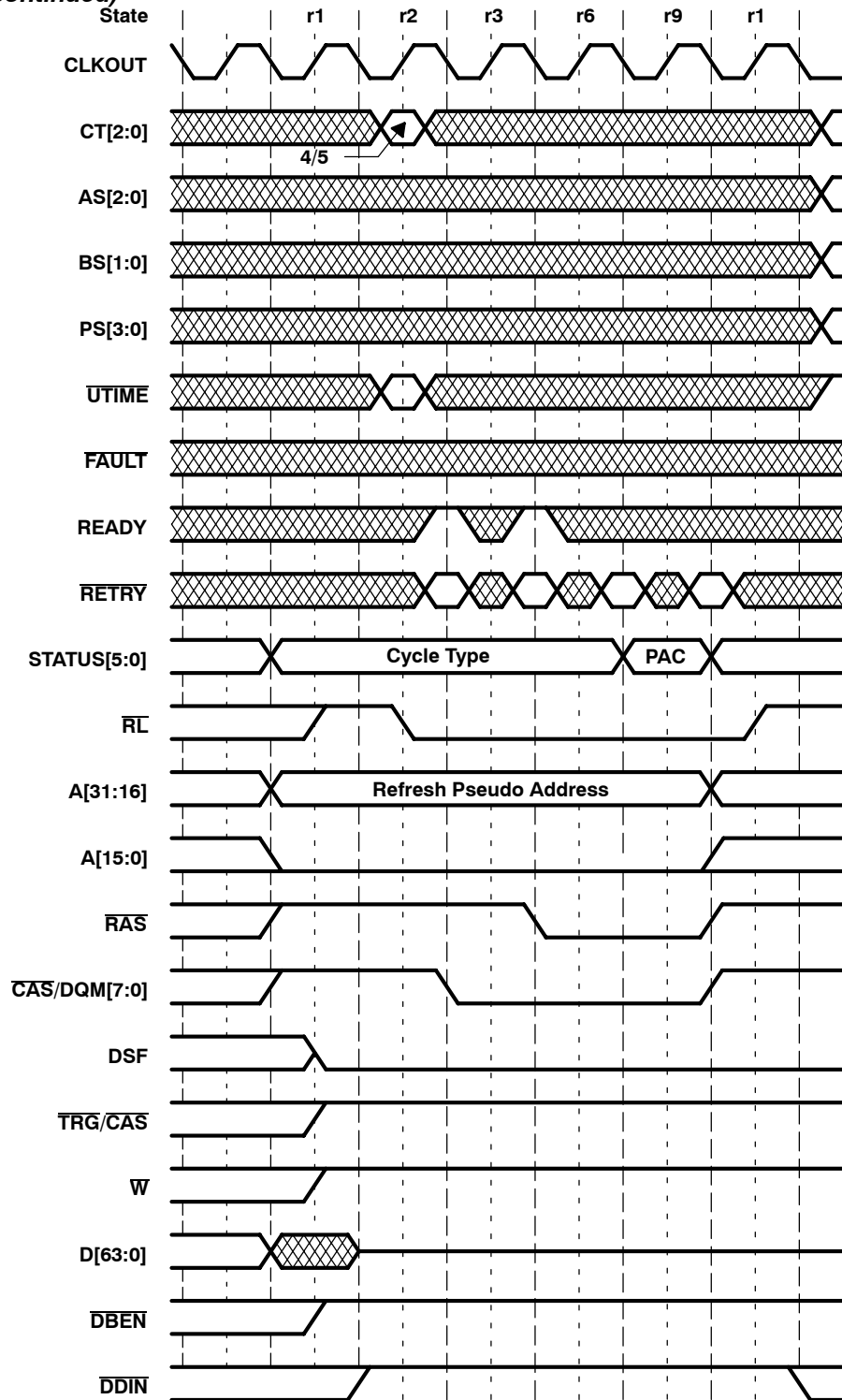

Figure 82. 1-Cycle/Column Refresh-Cycle Timing

refresh cycles (continued)

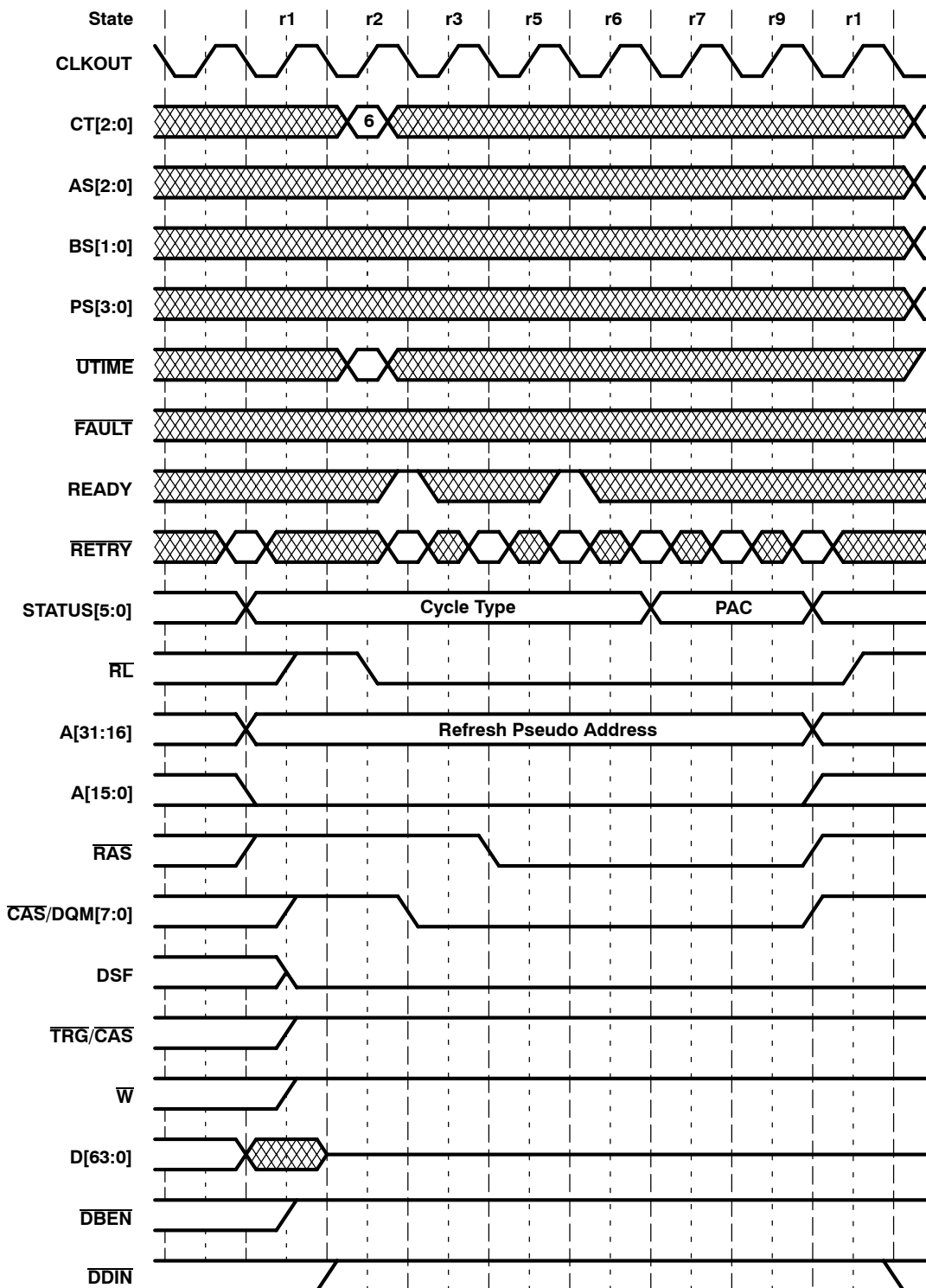

Figure 83. 2-Cycle/Column Refresh-Cycle Timing

SMJ320C80 DIGITAL SIGNAL PROCESSOR

SGUS025B - AUGUST 1998 - REVISED JUNE 2002

refresh cycles (continued)

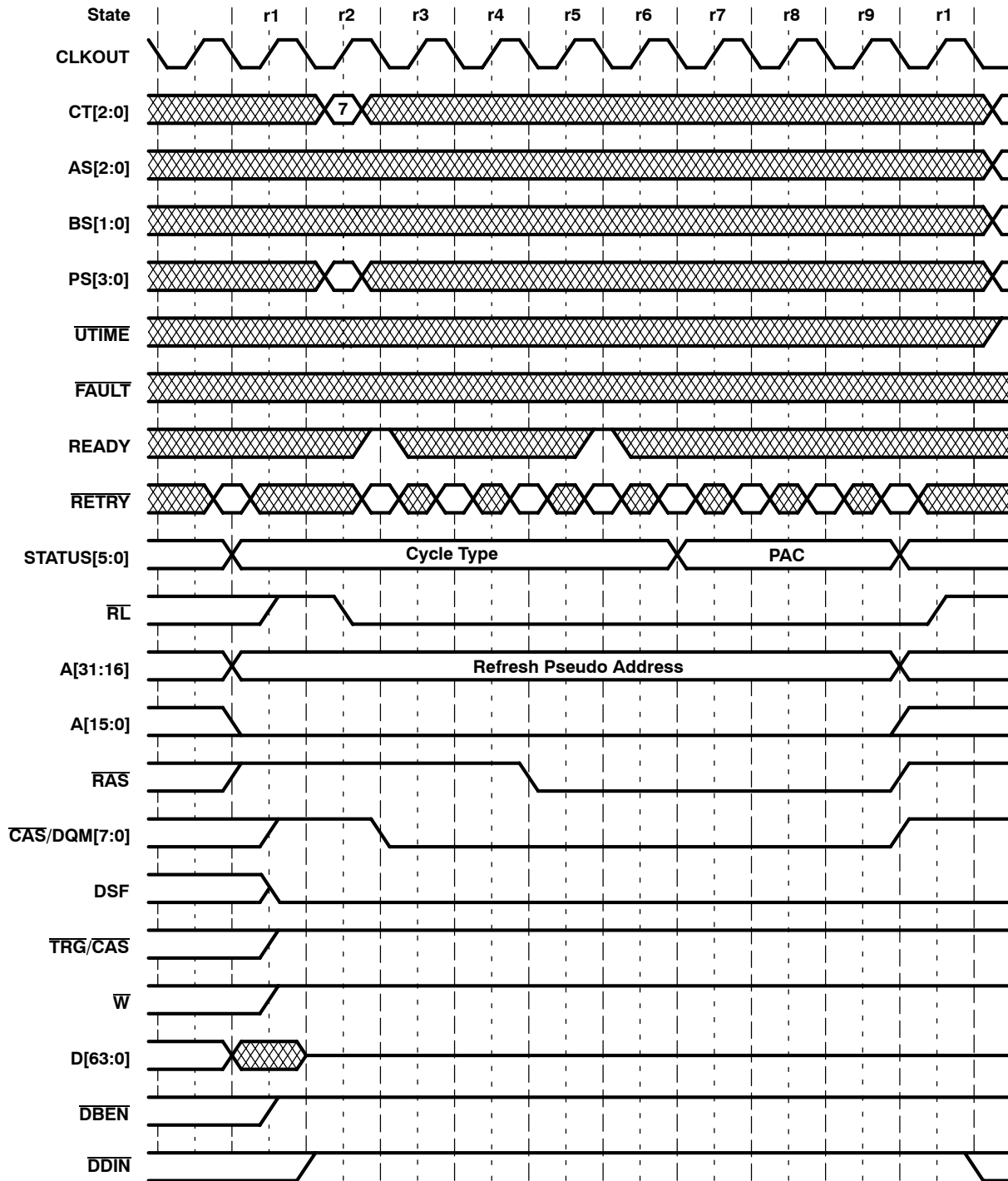

Figure 84. 3-Cycle/Column Refresh-Cycle Timing



POST OFFICE BOX 1443 • HOUSTON, TEXAS 77251-1443

SDRAM-type cycles

The SDRAM-type cycles support the use of SDRAM, SGRAM, or SVRAM devices for single-cycle memory accesses. While SDRAM cycles use the same state sequences as DRAM cycles, the memory-control signal transitions are modified to perform SDRAM command cycles. The supported SDRAM commands are:

DCAB	Deactivate (precharge) all banks
ACTV	Activate the selected bank and select the row
READ	Input starting column address and start read operation
WRT	Input starting column address and start write operation
MRS	Set SDRAM mode register
REFR	Auto-refresh cycle with internal address
SRS	Set special register (color register)
BLW	Block write

SDRAM cycles begin with an activate (ACTV) command followed by the requested column accesses. When a memory-page change occurs, the selected bank is deactivated with a DCAB command.

The SMJ320C80 supports CAS latencies of 2 or 3 cycles and burst lengths of 1 or 2. These are selected by the CT code input at the start of the access.

The column pipelines for SDRAM accesses are shown in Figure 85. Idle cycles can occur after necessary column accesses have completed or between column accesses due to "bubbles" in the TC data flow pipeline. The pipeline diagrams show the pipeline stages for each access type and when the $\overline{\text{CAS}}/\text{DQM}$ signal corresponding to the column access is activated.

SMJ320C80 DIGITAL SIGNAL PROCESSOR

SGUS025B - AUGUST 1998 - REVISED JUNE 2002

SDRAM type cycles (continued)

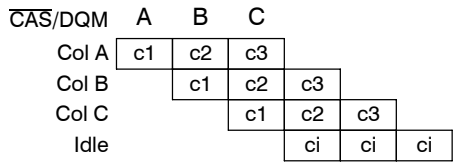

Burst-length 1, 2-cycle latency reads, read transfers, split-read transfers

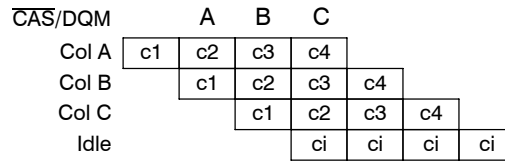

Burst-length 1, 3-cycle latency reads, read transfers, split-read transfers

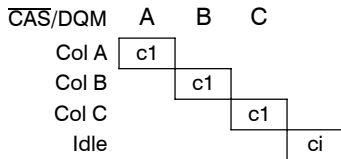

Burst-length 1 writes, block writes, SRSs, write transfers, split-write transfers

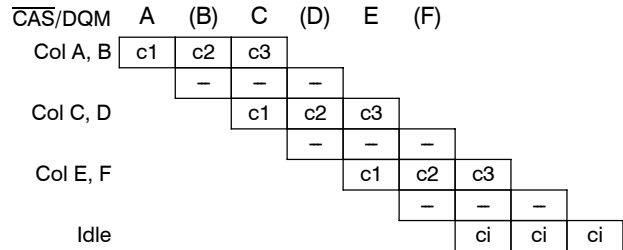

Burst-length 2, 2-cycle latency reads, read transfers, split-read transfers

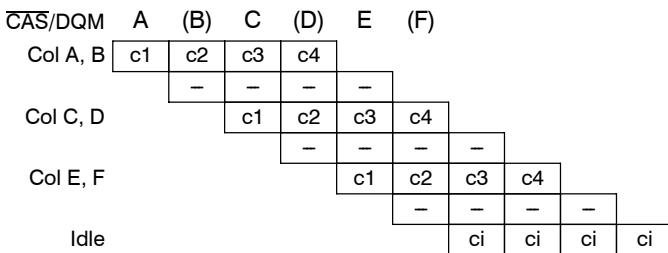

Burst-length 2, 3-cycle latency reads, read transfers, split-read transfers

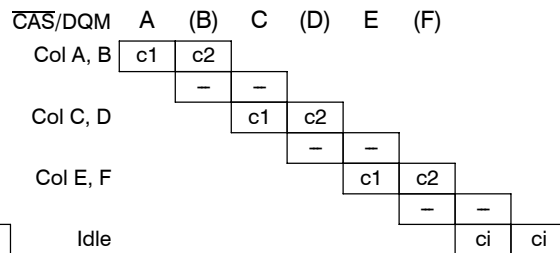

Burst-length 2, 3-cycle latency writes

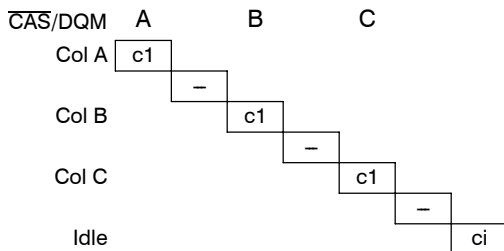

Burst-length 2, 3-cycle latency block-writes, write transfers, split-write transfers

Figure 85. SDRAM Column Pipelines

special SDRAM cycles

To initialize the SDRAM properly, the SMJ320C80 performs two special SDRAM cycles after reset. The 'C80 first performs a deactivate cycle on all banks (DCAB) and then initializes the SDRAM mode register with a mode register set (MRS) cycle. The CT code input at the start of the MRS cycle determines the burst length and latency that is programmed into the SDRAM mode register.

special SDRAM cycles (continued)

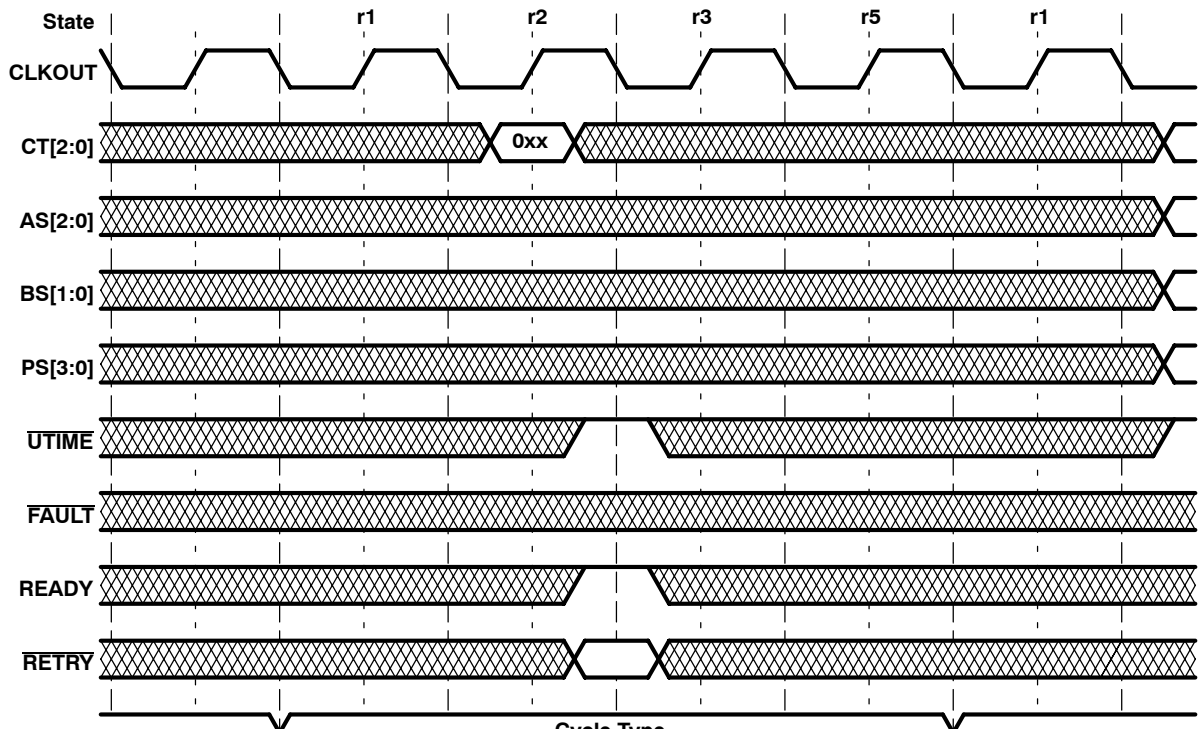

Figure 86. SDRAM Power-Up Deactivate Cycle Timing

special SDRAM cycles (continued)

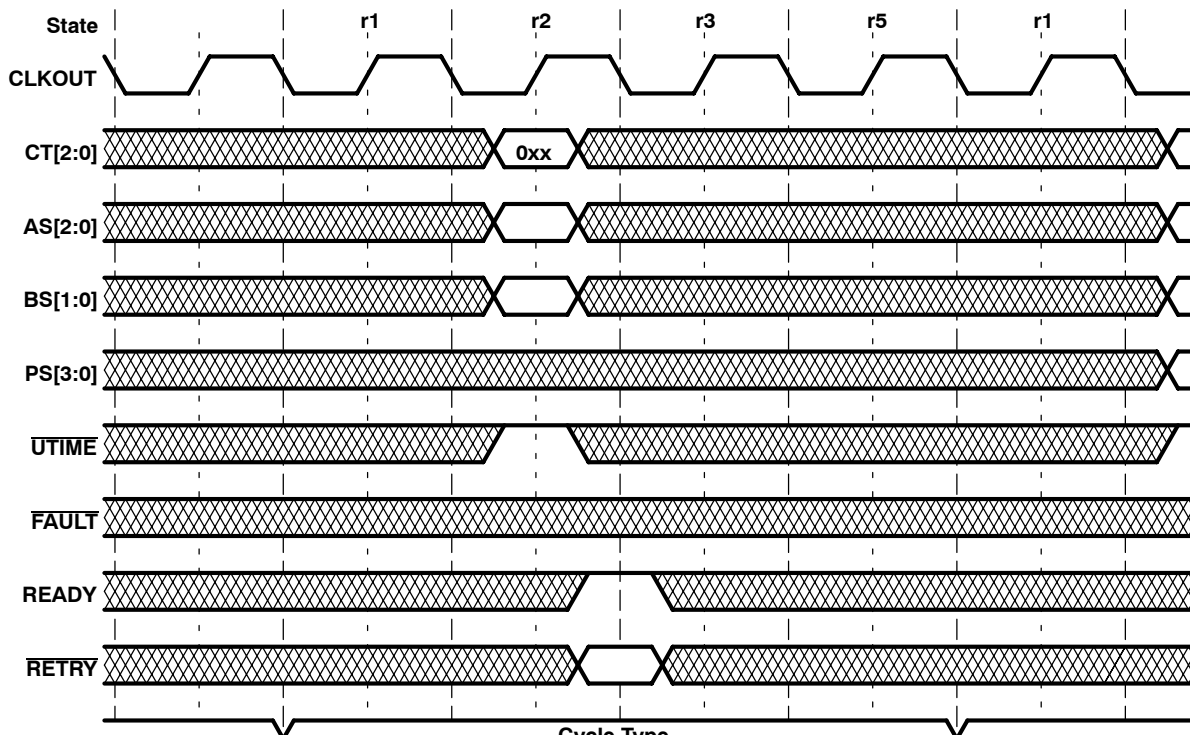

Figure 87. SDRAM Mode-Register-Set Cycle Timing

SDRAM read cycles

Read cycles begin with an activate (ACTV) command to activate the bank and to select the row. The TC outputs the column address and activates the TRG/CAS strobe for each read command. For burst-length 1 accesses, a read command can occur on each cycle. For burst-length 2 accesses, a read command can occur every two cycles. The TC places D[63:0] into the high-impedance state, allowing it to be driven by the memory, and latches input data during the appropriate column state. The TC always reads 64 bits and extracts and aligns the appropriate bytes. Invalid bytes for bus sizes of less than 64 bits are discarded. The CAS/DQM strobes are activated two cycles before input data is latched. If the second column in a burst is not required, then CAS/DQM is not activated. During peripheral device packet transfers, DBEN remains high.

SDRAM read cycles (continued)

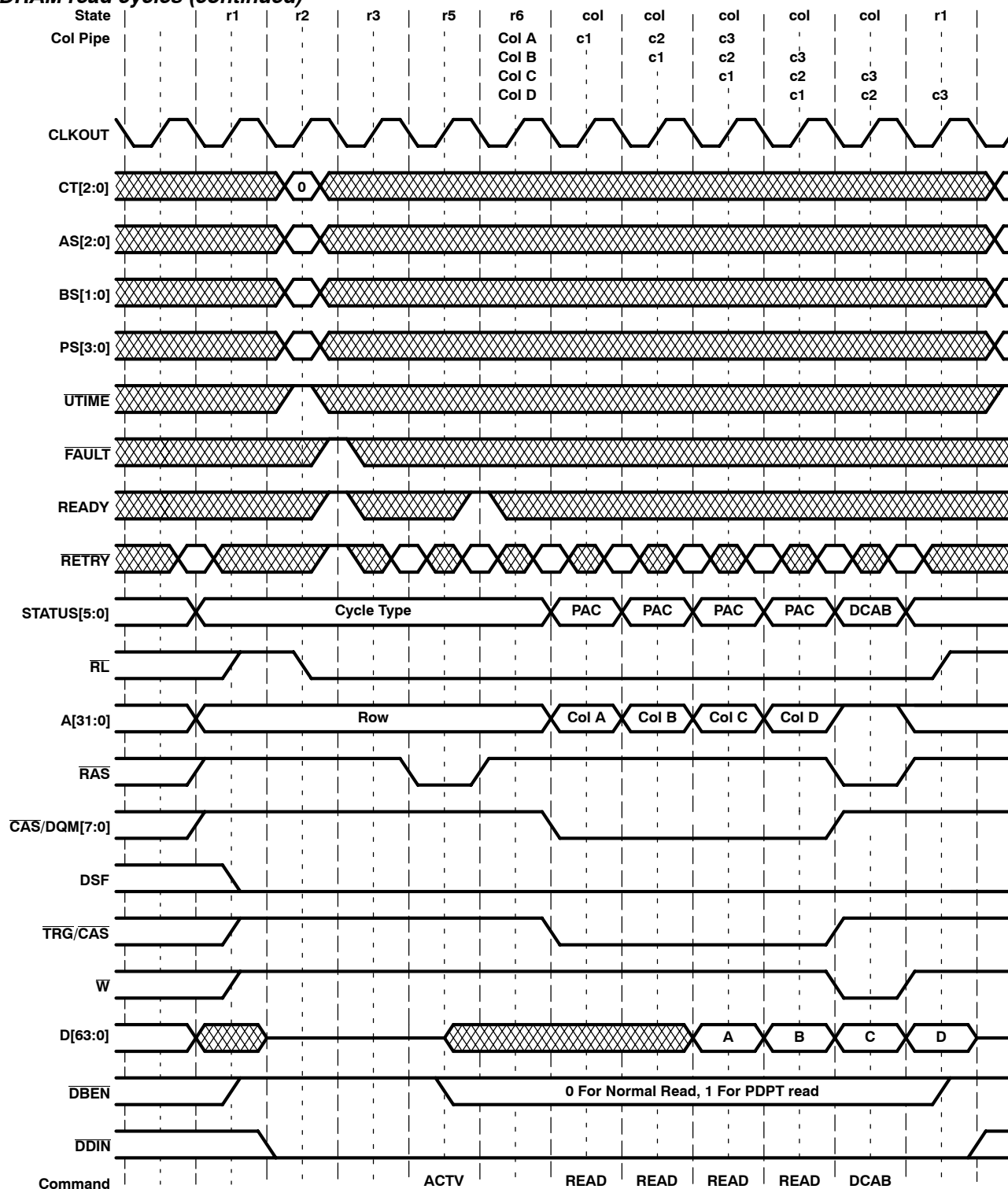

Figure 88. SDRAM Burst-Length 1, 2-Cycle Latency Read-Cycle Timing

SMJ320C80 DIGITAL SIGNAL PROCESSOR

SGUS025B - AUGUST 1998 - REVISED JUNE 2002

SDRAM read cycles (continued)

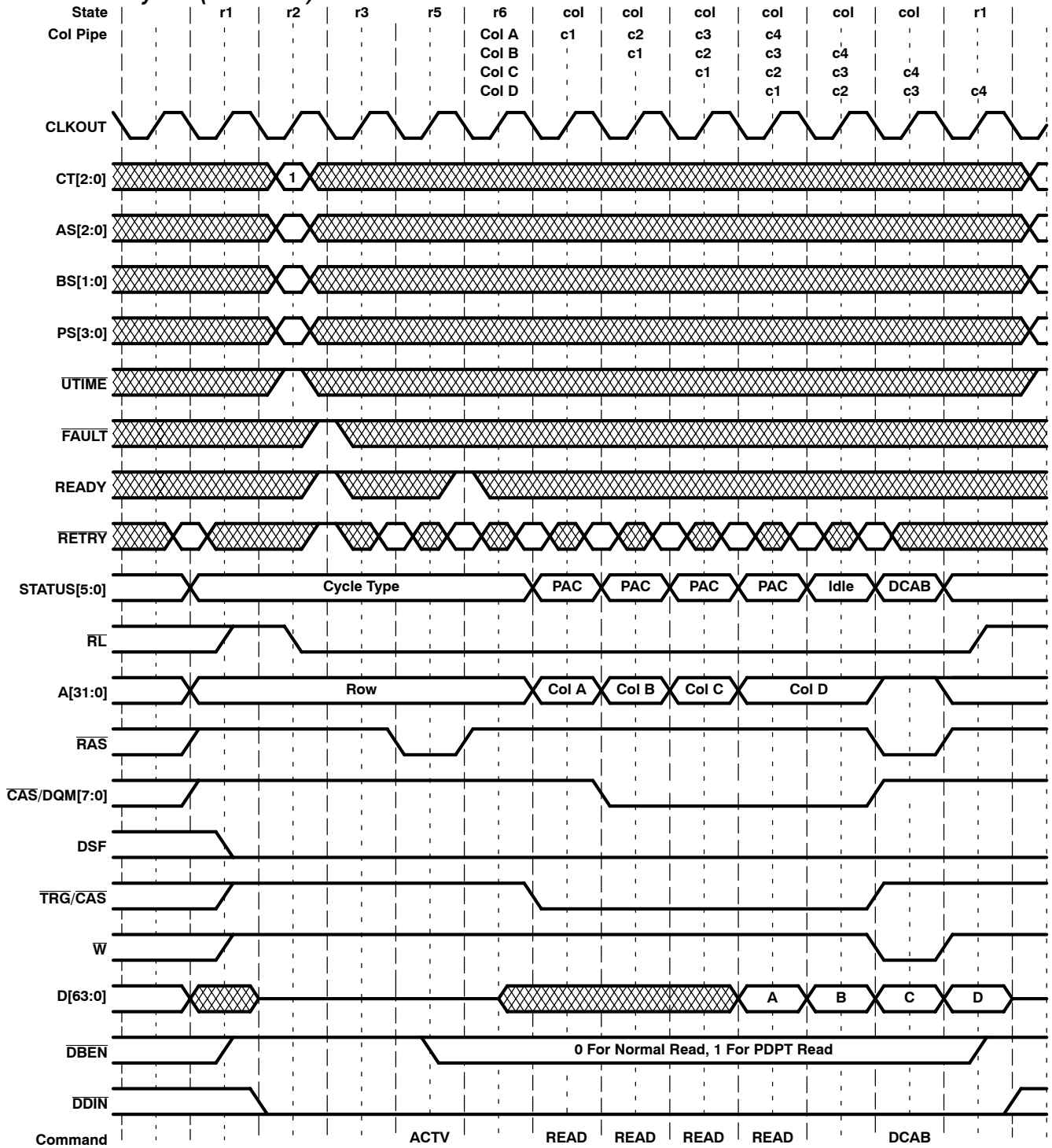

Figure 89. SDRAM Burst-Length 1, 3-Cycle Latency Read-Cycle Timing



SDRAM read cycles (continued)

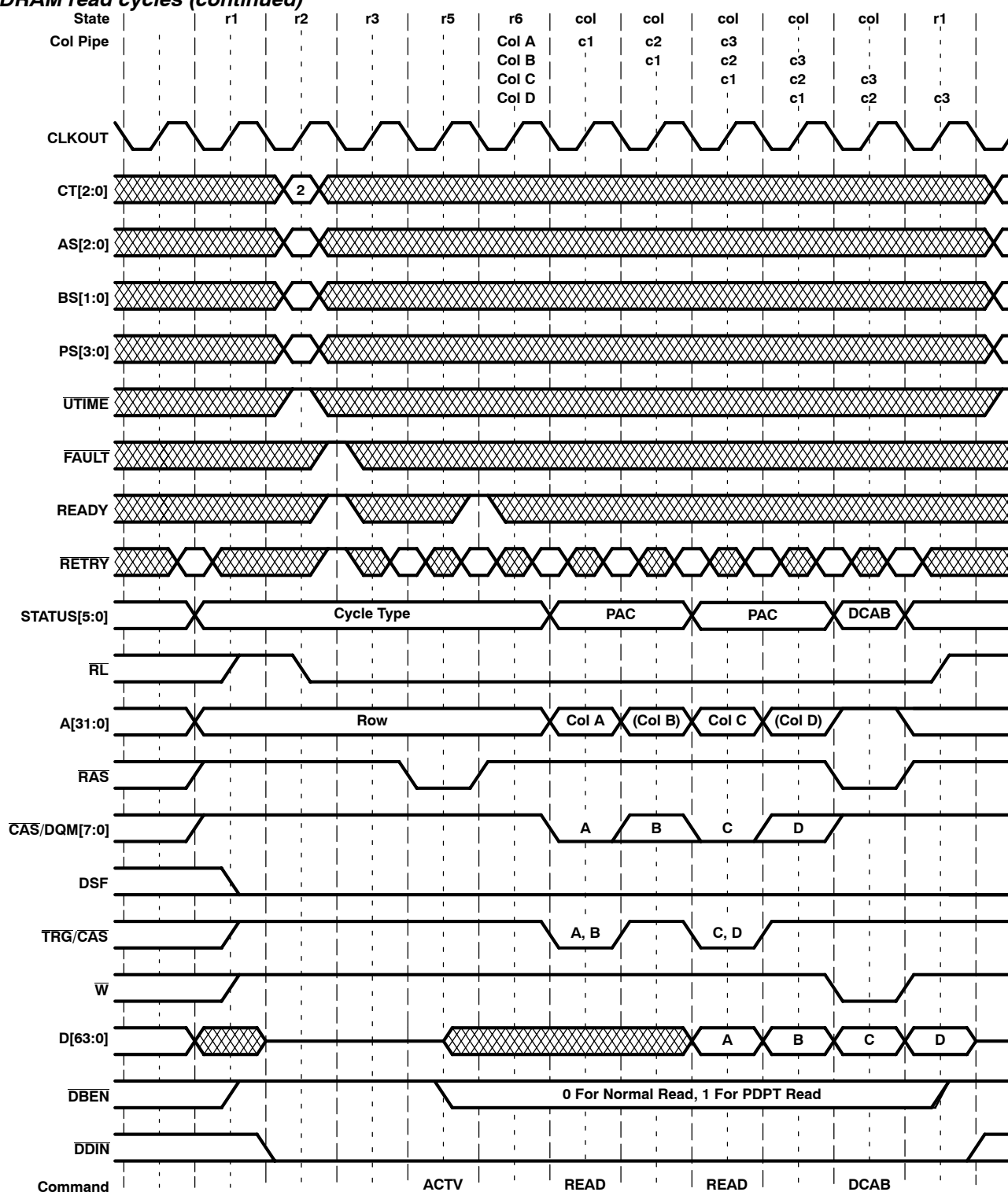

Figure 90. SDRAM Burst-Length 2, 2-Cycle Latency Read-Cycle Timing

SMJ320C80 DIGITAL SIGNAL PROCESSOR

SGUS025B - AUGUST 1998 - REVISED JUNE 2002

SDRAM read cycles (continued)

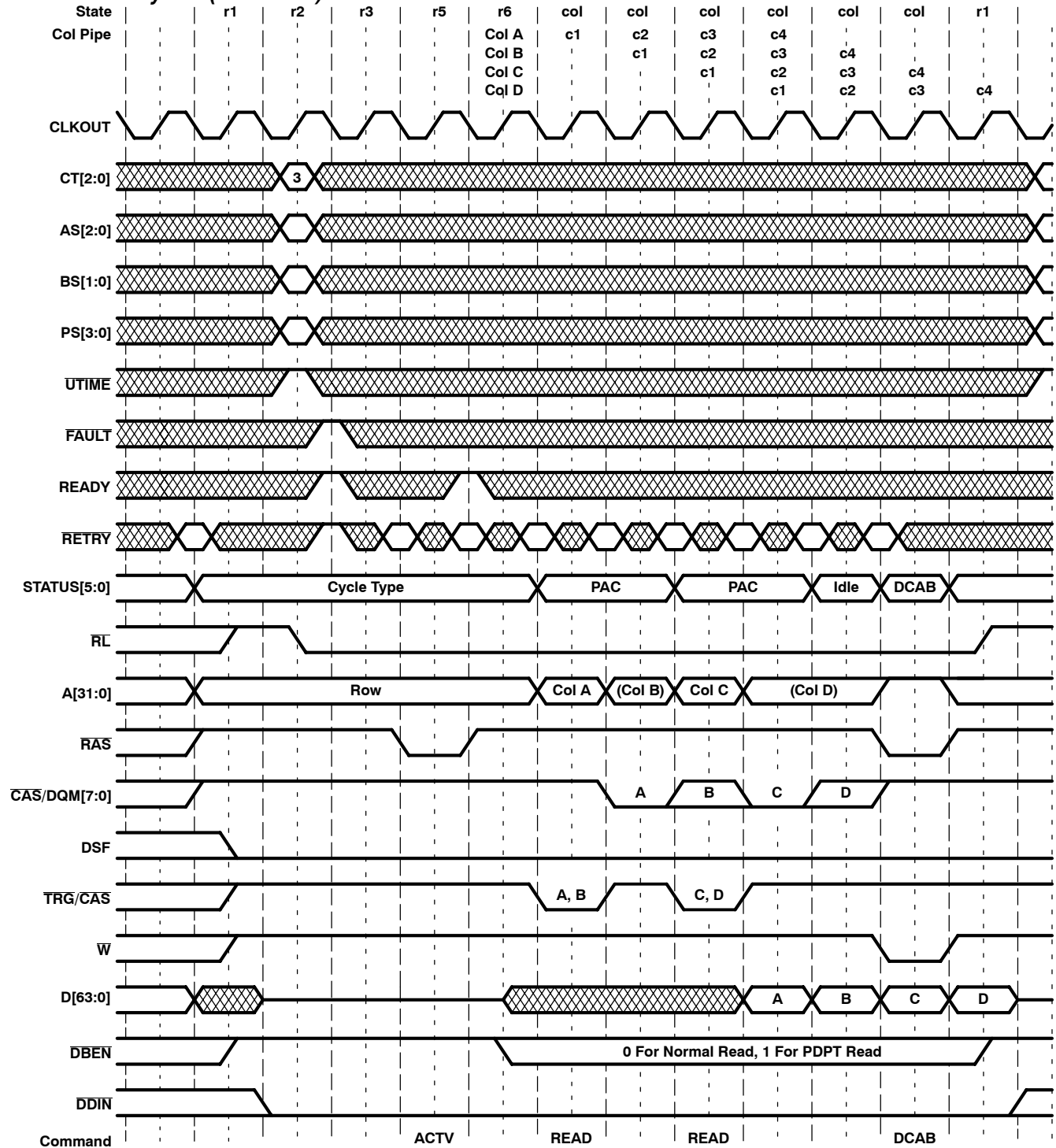

Figure 91. SDRAM Burst-Length 2, 3-Cycle Latency Read-Cycle Timing



SDRAM write cycles

Write cycles begin with an activate (ACTV) command to activate the bank and select the row. The TC outputs the column address and activates the $\overline{\text{TRG/CAS}}$ and $\overline{\text{W}}$ strobes for each write command. For burst-length 1 accesses, a write command can occur on each cycle. For burst-length 2 accesses, a write command can occur every two cycles. The TC drives data out on D[63:0] during each cycle of an active-write command and indicates valid bytes by driving the appropriate $\overline{\text{CAS/DQM}}$ strobes low. During peripheral device packet transfers, $\overline{\text{DBEN}}$ remains high and D[63:0] are placed in the high-impedance state so that the peripheral can drive data into the memories.

SMJ320C80 DIGITAL SIGNAL PROCESSOR

SGUS025B - AUGUST 1998 - REVISED JUNE 2002

SDRAM write cycles (continued)

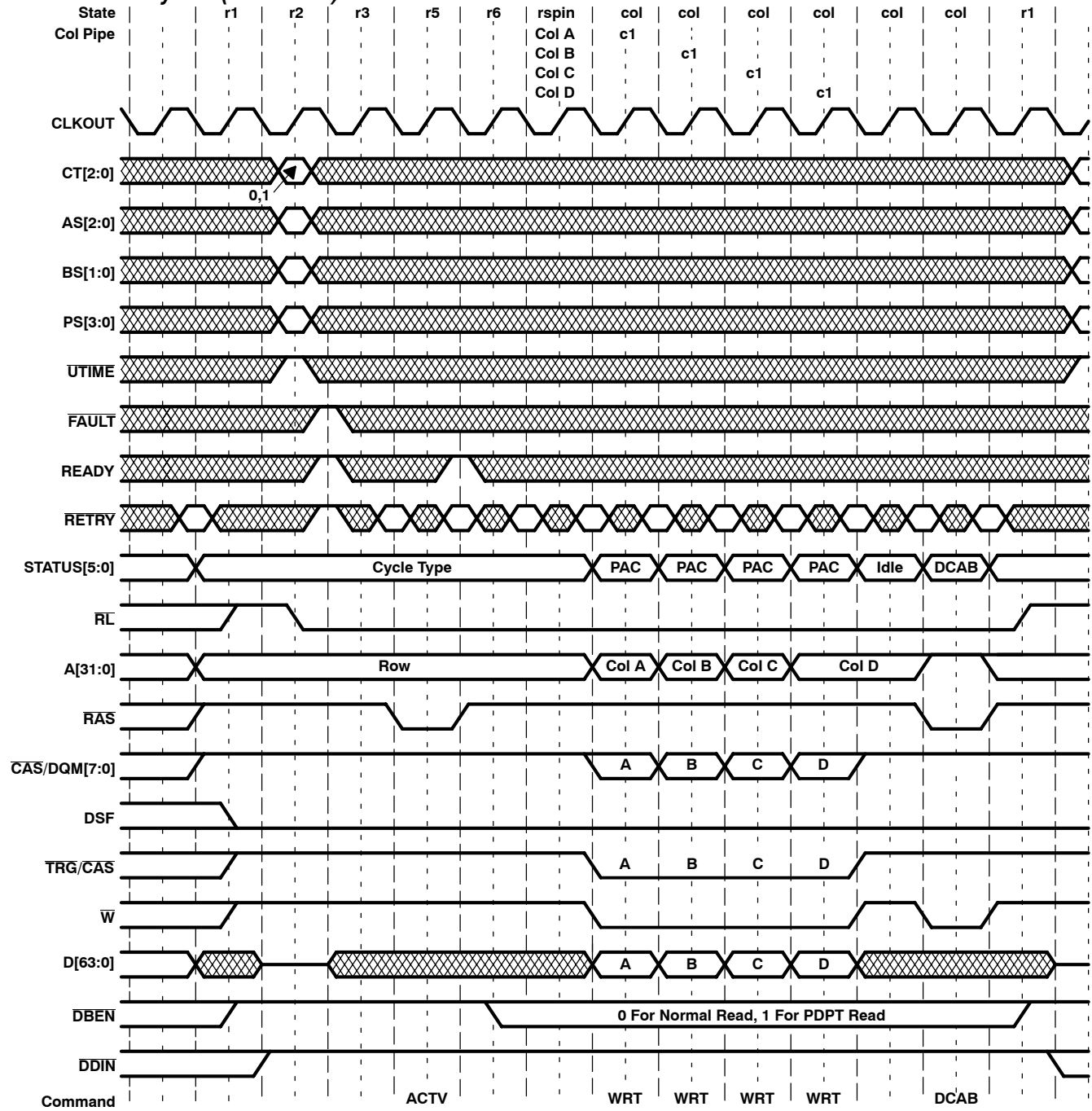

Figure 92. SDRAM Burst-Length 1 Write-Cycle Timing



POST OFFICE BOX 1443 • HOUSTON, TEXAS 77251-1443

SDRAM write cycles (continued)

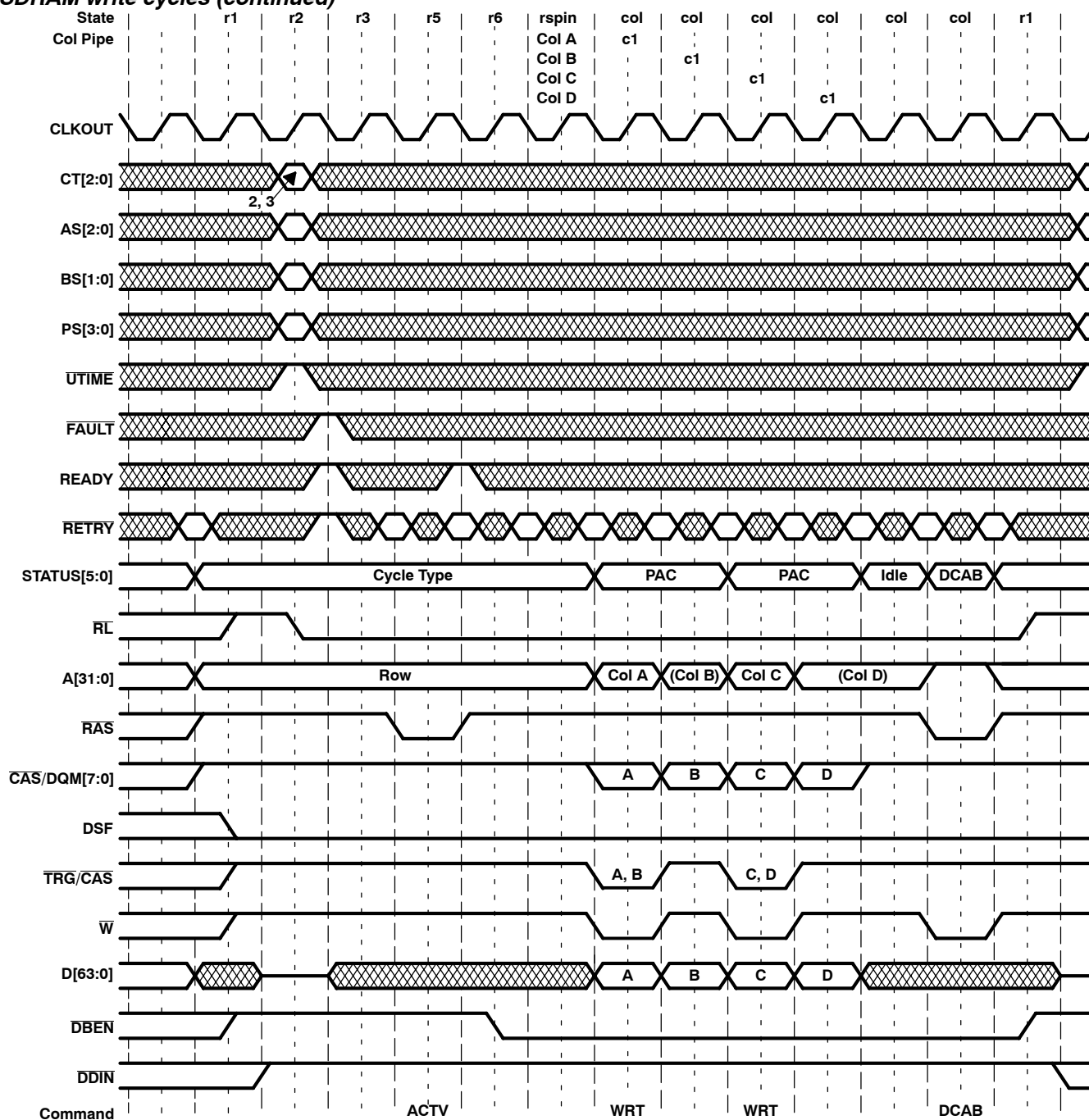

Figure 93. SDRAM Burst-Length 2 Write-Cycle Timing

SMJ320C80 DIGITAL SIGNAL PROCESSOR

SGUS025B - AUGUST 1998 - REVISED JUNE 2002

special register set cycles

Special register set (SRS) cycles are used to program control registers within an SVRAM or SGRAM. The 'C80 only supports programming of the color register for use with block-writes. The cycle is similar to a single burst length 1 write cycle but DSF is driven high. The values output on the 'C80 address bits cause the color register to be selected as shown in Figure 94.

SDRAM Address Pin	BS	A8	A7	A6	A5	A4	A3	A2	A1	A0
SDRAM Function	0	0	0	LC	LM	LS	Stop Register			
SMJ320C80 Output Value	0	0	0	1	0	0	0	0	0	0

Figure 94. Special-Register-Set Value

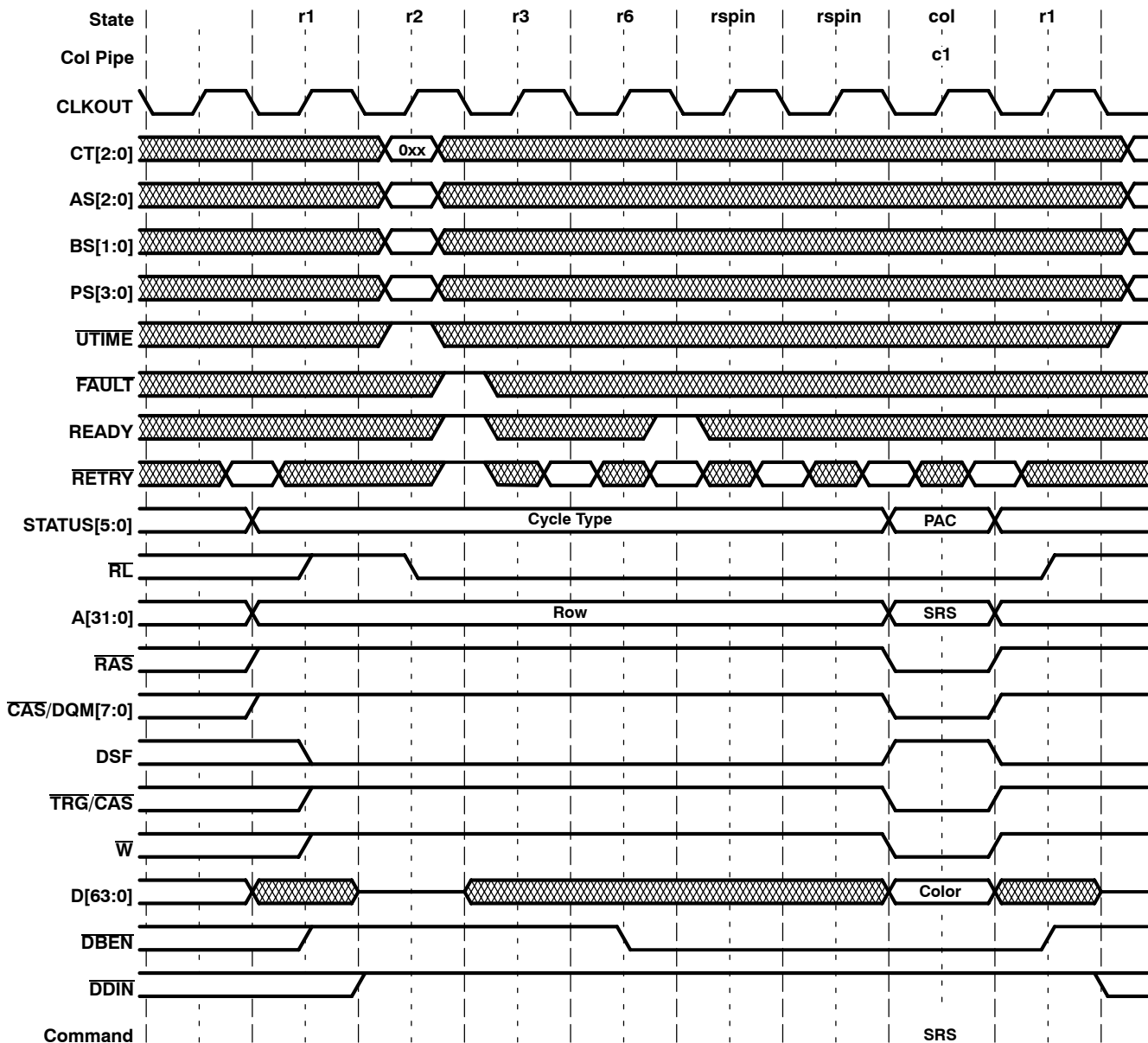

Figure 95. SDRAM SRS-Cycle Timing



POST OFFICE BOX 1443 • HOUSTON, TEXAS 77251-1443

SDRAM block-write cycles

Block-write cycles allow SVRAMs and SGRAMs to write a stored color value to multiple column locations in a single access. Block-write cycles are similar to write cycles except that DSF is driven high to indicate a block-write command. Because burst is not supported for block-write, burst-length 2 accesses generate a single block-write every other clock cycle.

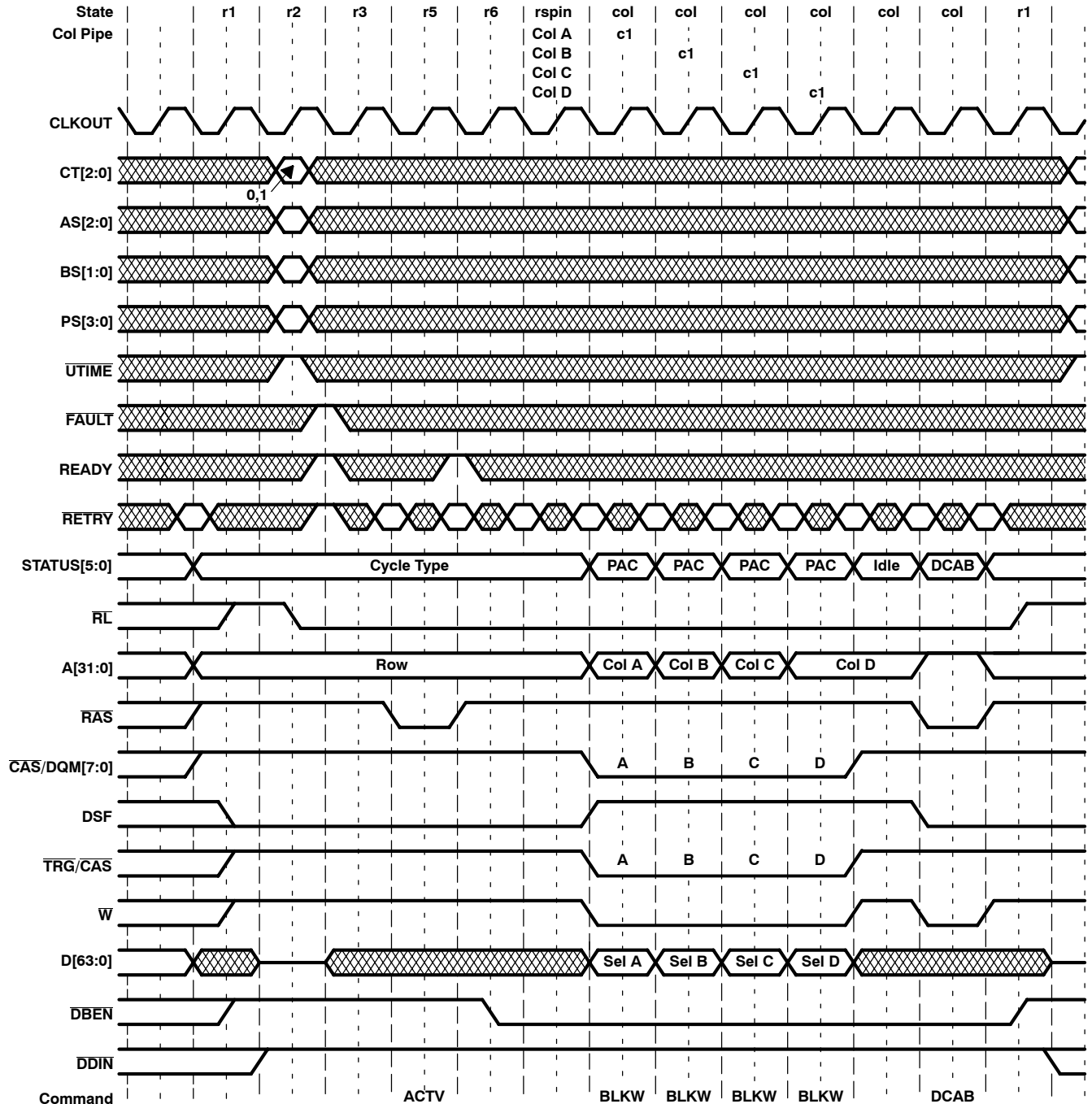

Figure 96. SDRAM Burst-Length 1 Block-Write Cycle Timing

SMJ320C80 DIGITAL SIGNAL PROCESSOR

SGUS025B - AUGUST 1998 - REVISED JUNE 2002

SDRAM block-write cycles (continued)

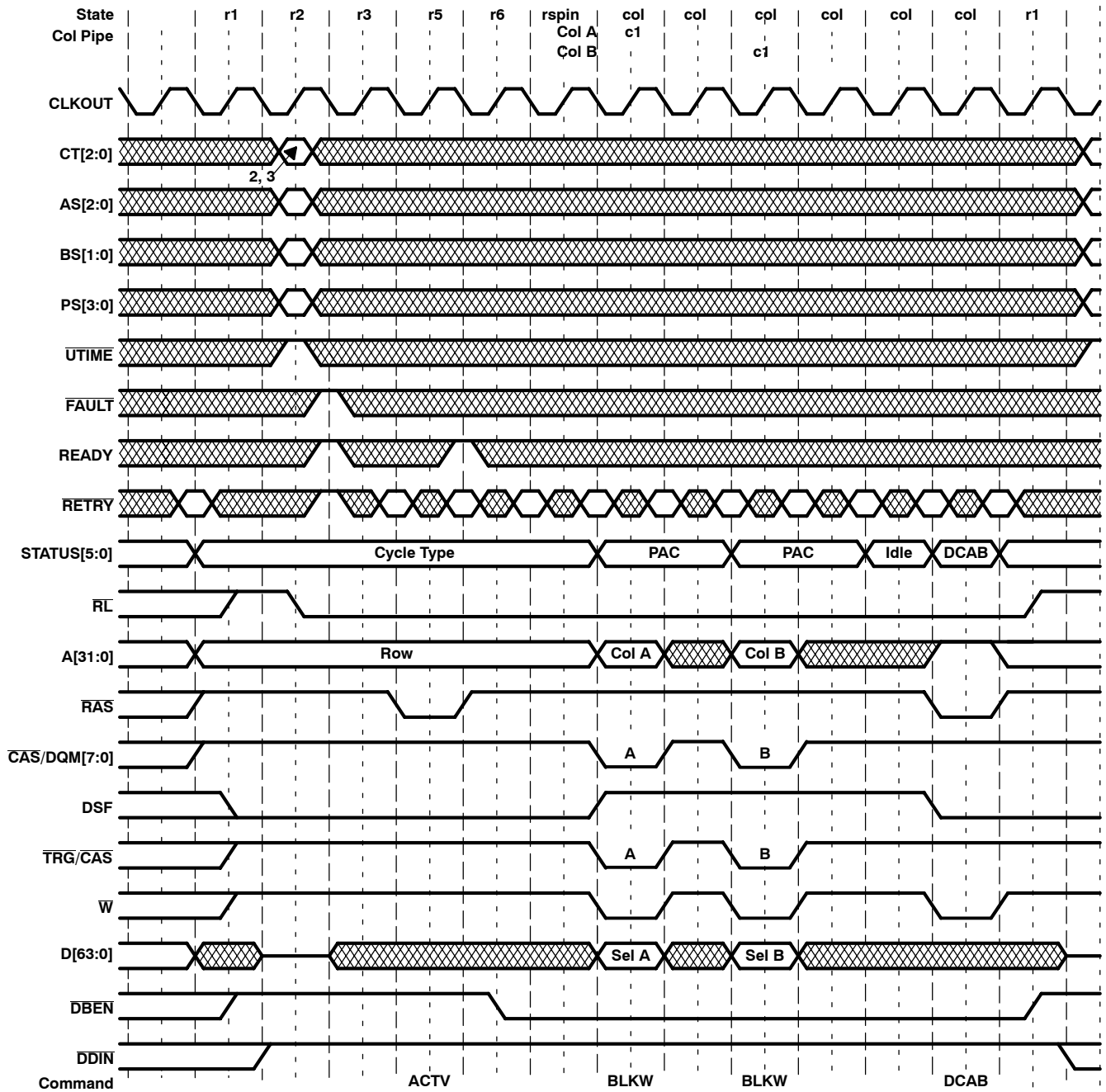

Figure 97. SDRAM Burst-Length 2 Block-Write Cycle Timing



SVRAM transfer cycles

The SVRAM read- and write-transfer cycles transfer data between the SVRAM memory-array and the serial register (SAM). The SMJ320C80 supports both normal and split transfers for SVRAMs. Read- and split-read transfers resemble a standard read cycle. Write- and split-write transfers resemble a standard write cycle. Because the 'C80's TRG output is used as $\overline{\text{CAS}}$, external logic must generate a TRG signal (by decoding STATUS) to enable the SVRAM transfer cycle. The value output on A[31:0] at column time represents the SAM tap point.

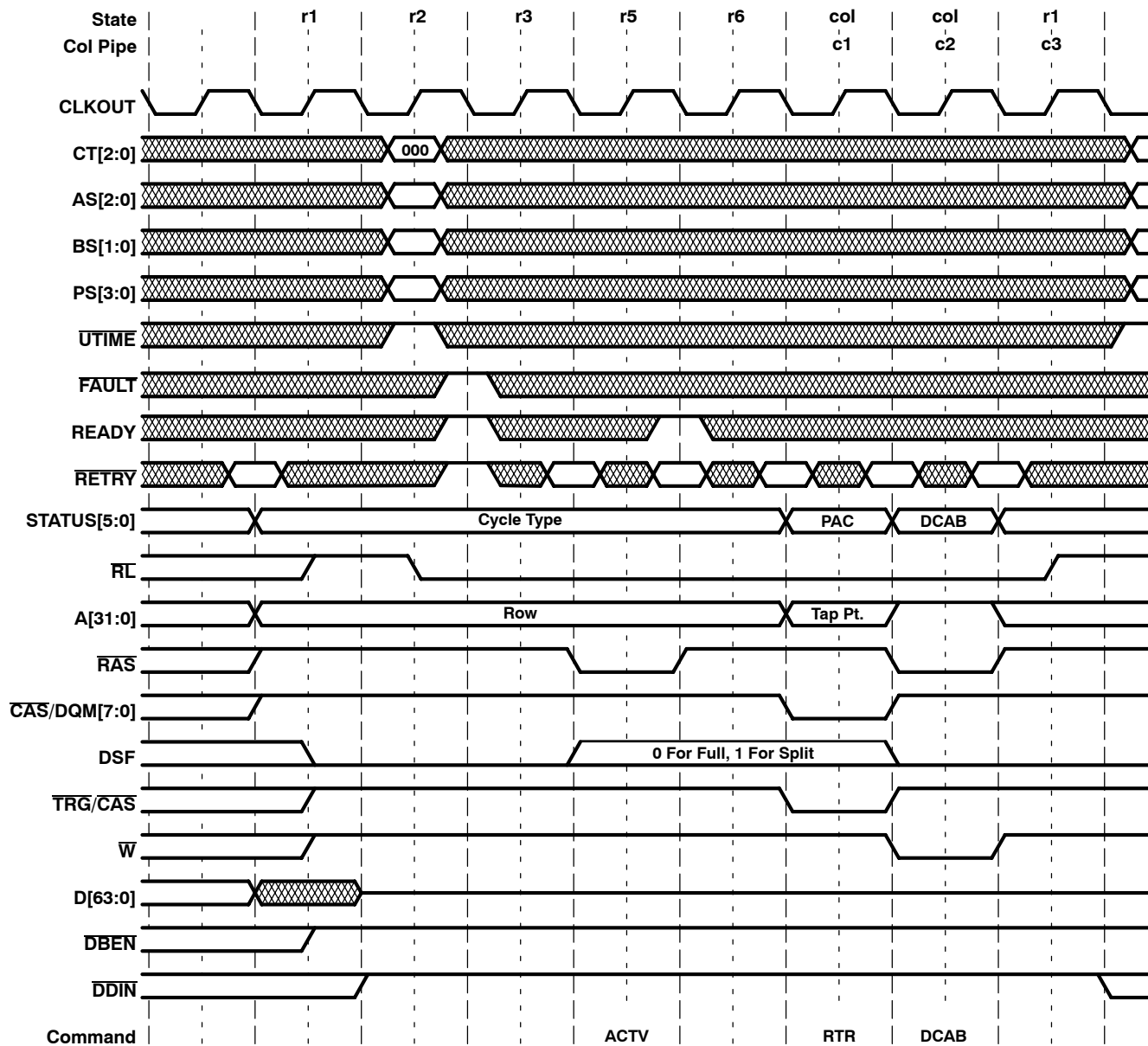

Figure 98. SVRAM Burst-Length 1, 2-Cycle Latency Read-Transfer Cycle Timing

SMJ320C80 DIGITAL SIGNAL PROCESSOR

SGUS025B - AUGUST 1998 - REVISED JUNE 2002

SVRAM transfer cycles (continued)

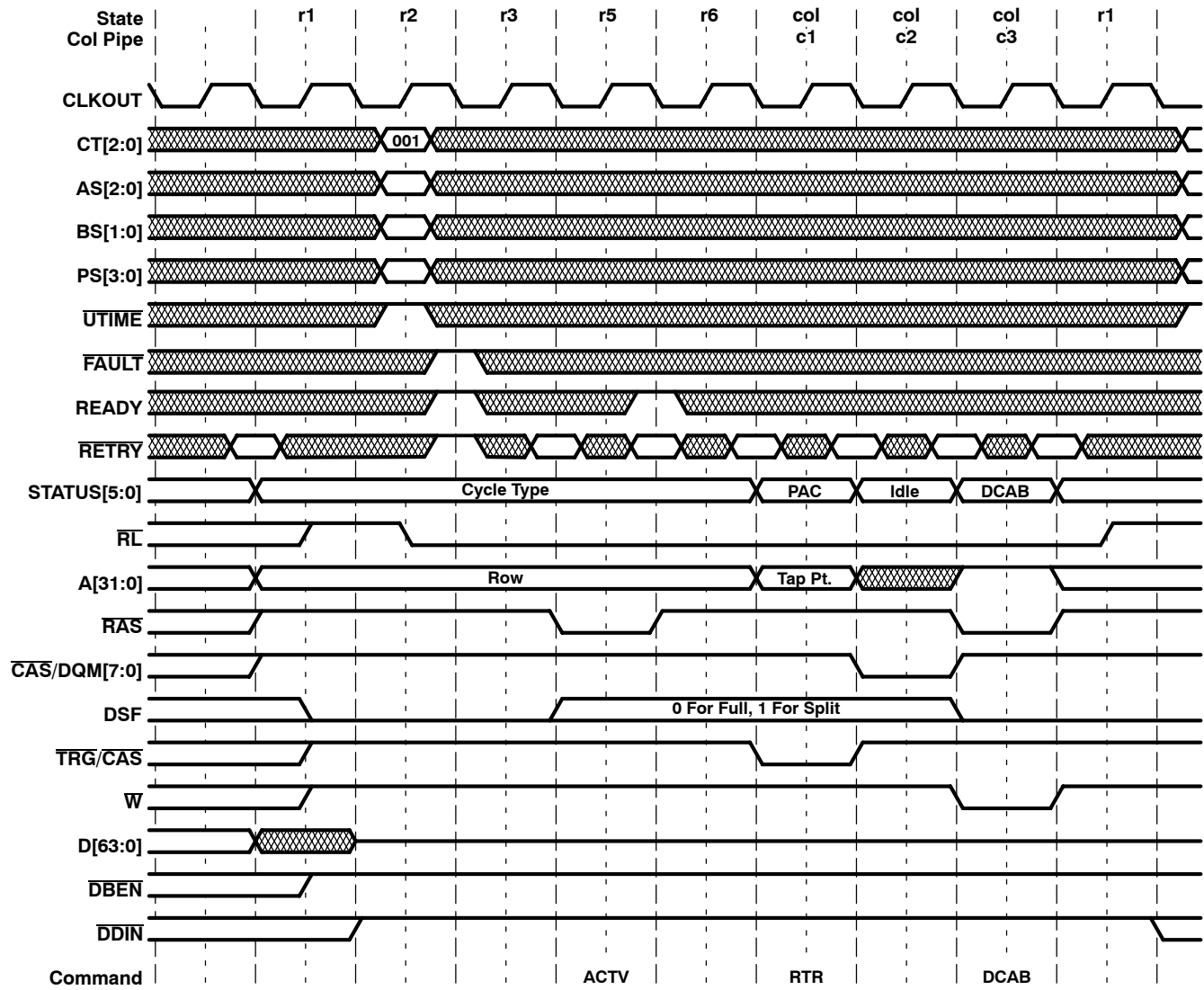

Figure 99. SVRAM Burst-Length 1, 3-Cycle Latency Read-Transfer Cycle Timing

SVRAM transfer cycles (continued)

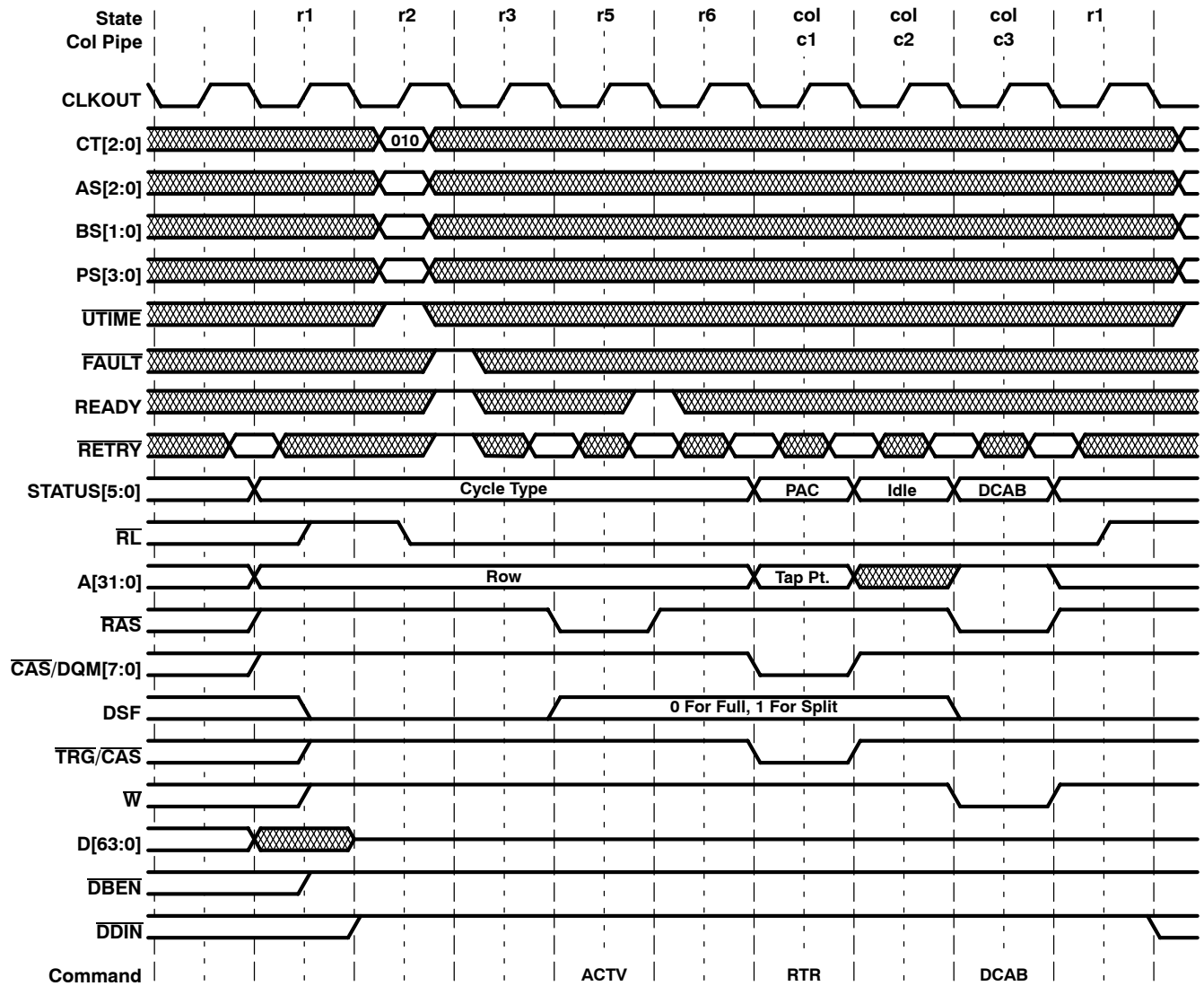

Figure 100. SVRAM Burst-Length 2, 2-Cycle Latency Read-Transfer Cycle Timing

SMJ320C80 DIGITAL SIGNAL PROCESSOR

SGUS025B - AUGUST 1998 - REVISED JUNE 2002

SVRAM transfer cycles (continued)

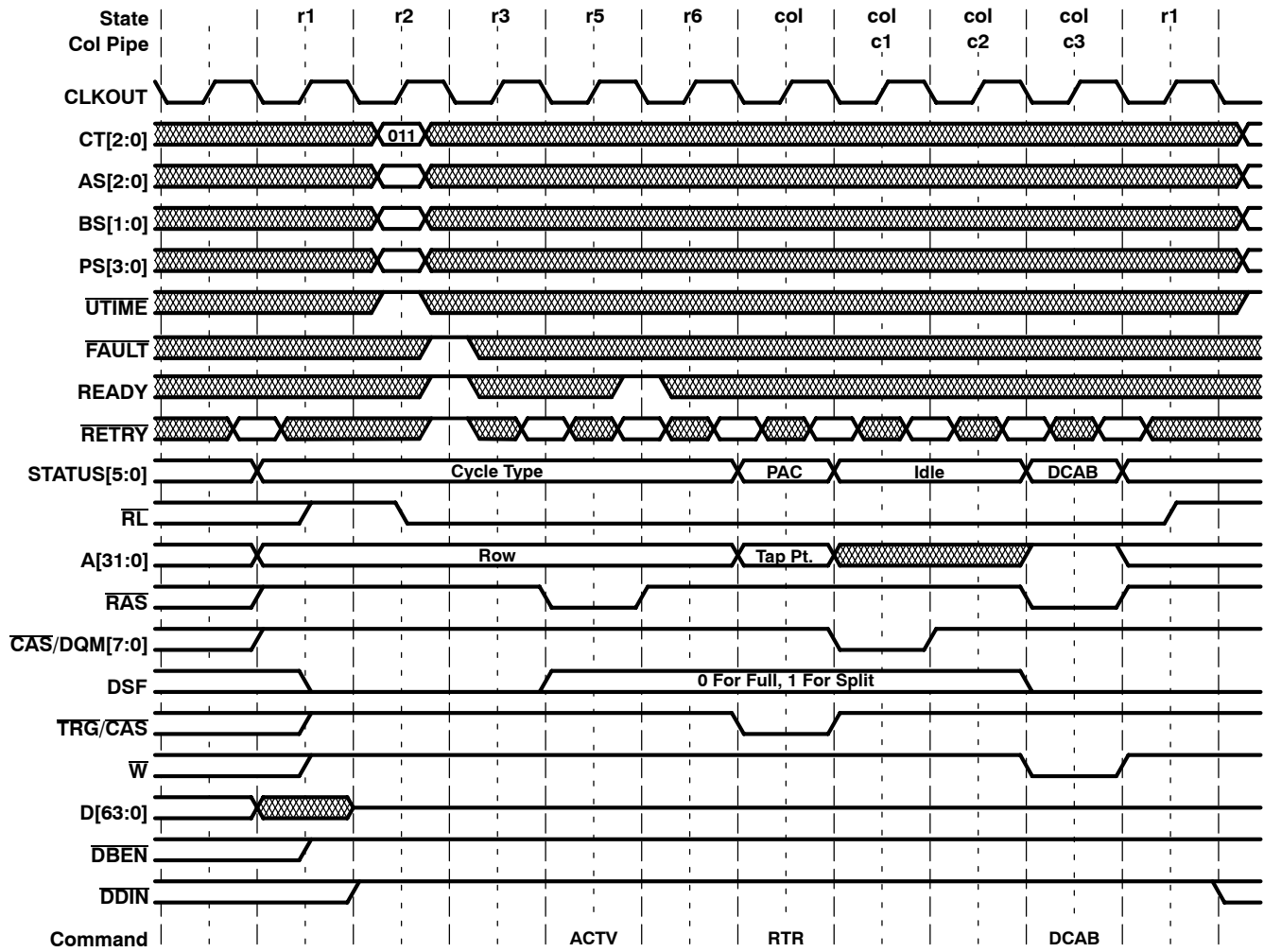

Figure 101. SVRAM Burst-Length 2, 3-Cycle Latency Read-Transfer Cycle Timing

SVRAM transfer cycles (continued)

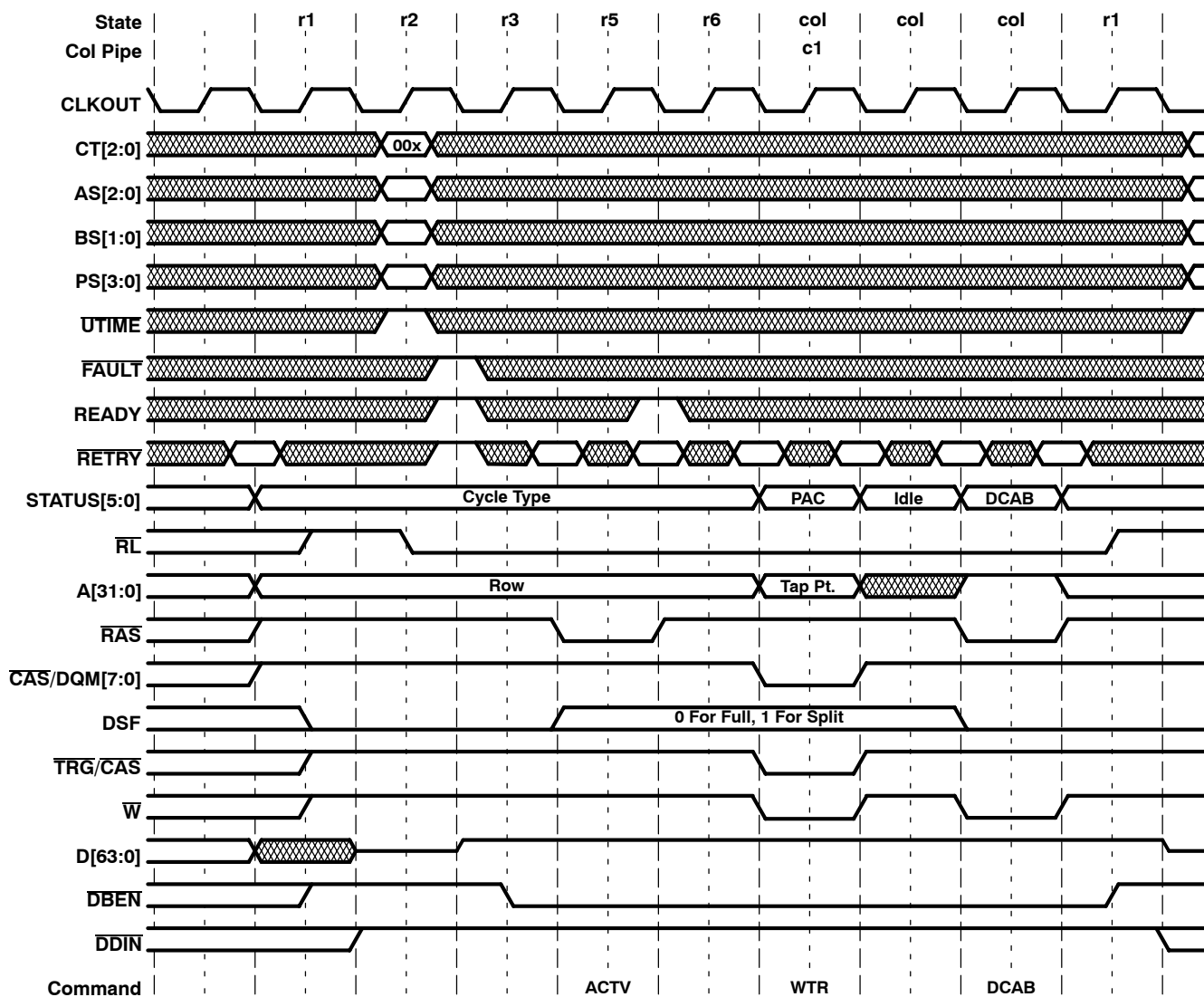

Figure 102. SVRAM Burst-Length 1, Write-Transfer Cycle Timing

SMJ320C80 DIGITAL SIGNAL PROCESSOR

SGUS025B - AUGUST 1998 - REVISED JUNE 2002

SVRAM transfer cycles (continued)

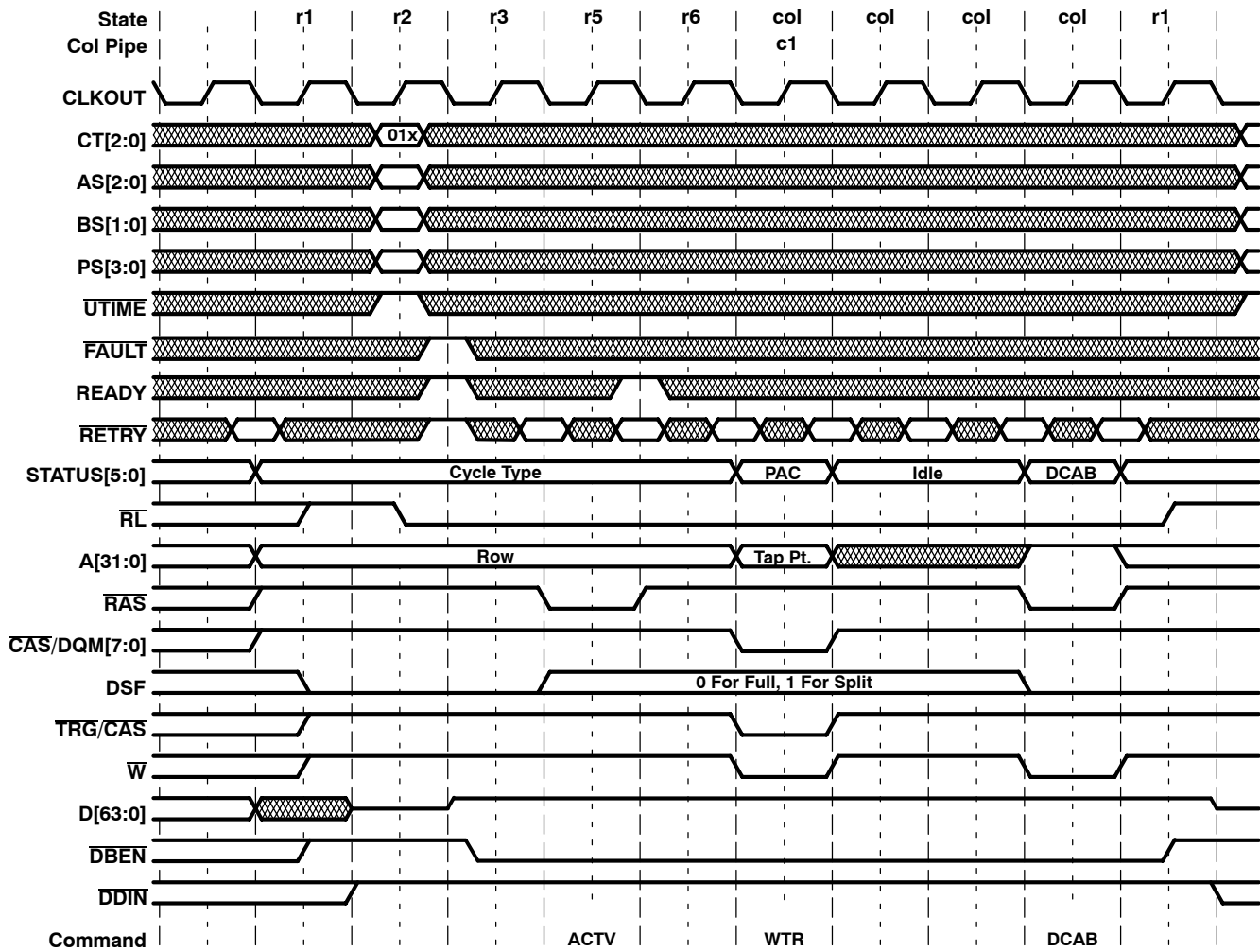

Figure 103. SVRAM Burst-Length 2, Write-Transfer Cycle Timing

SDRAM refresh cycle

The SDRAM refresh cycle is performed when the TC receives an SDRAM cycle timing input (CT=0xx) at the start of a refresh cycle. The \overline{RAS} and $\overline{TRG/CAS}$ outputs are driven low for one cycle to strobe a refresh command (REFR) into the SDRAM. The refresh address is generated internal to the SDRAM. The 'C80 outputs a 16-bit pseudo-address (used for refresh bank decode) on A[31:16] and drives A[15:0] low.

SDRAM refresh cycle (continued)

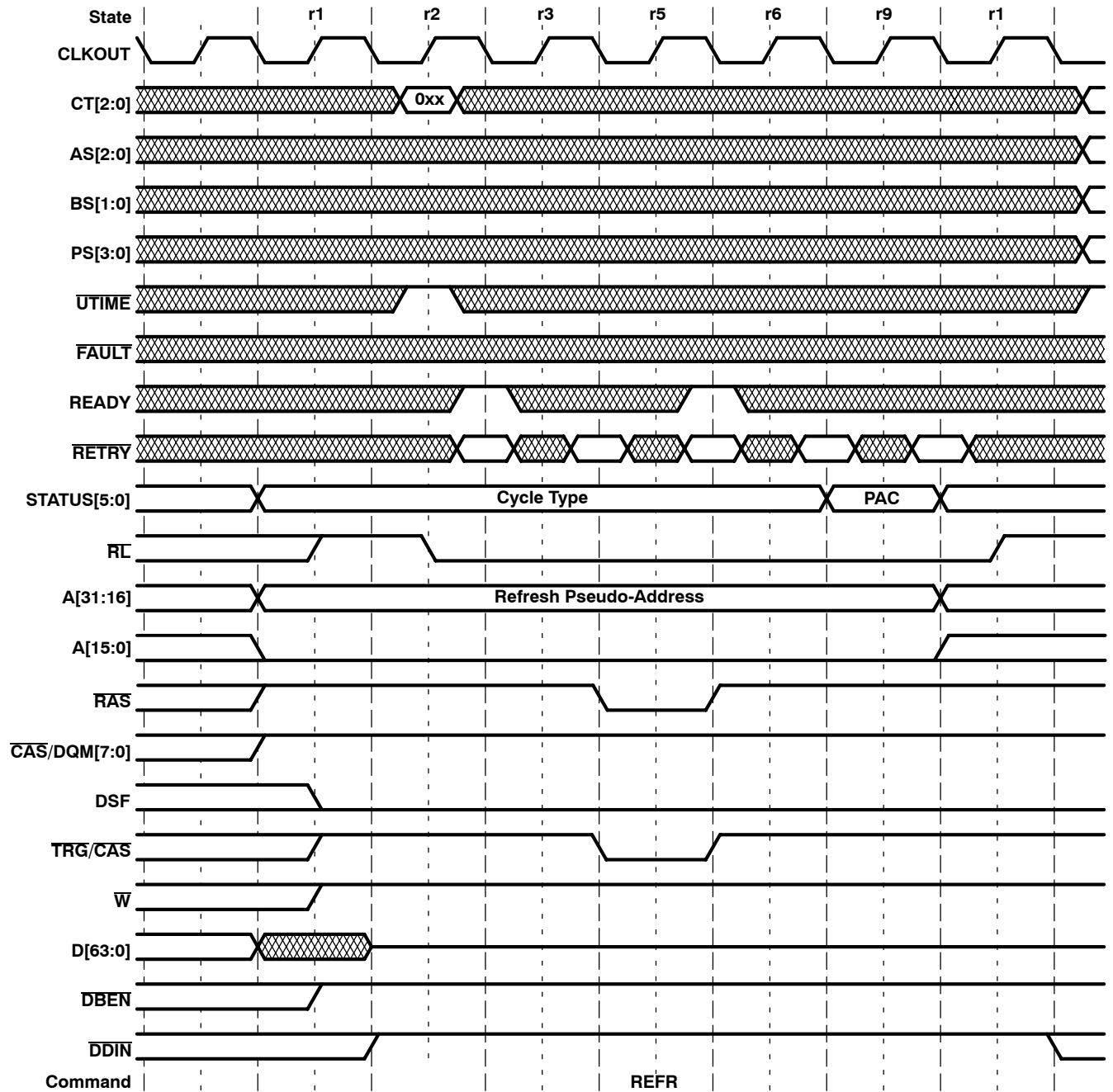

Figure 104. SDRAM Refresh Cycle Timing

host interface

The 'C80 contains a simple four-pin mechanism by which a host or another device can gain control of the 'C80 local memory bus. The $\overline{\text{HREQ}}$ input can be driven low by the host to request the 'C80's bus. Once the TC has completed the current memory access, it places the local bus (except CLKOUT) into a high-impedance state. It then drives the $\overline{\text{HACK}}$ output low to indicate that the host device owns the bus and can drive it. The REQ[1:0] outputs reflect the highest-priority cycle request being received internally by the TC. The host can monitor these outputs to determine if it needs to relinquish the local bus back to the 'C80.

Table 37. TC Priority Cycles

REQ[1:0]	ASSOCIATED INTERNAL TC REQUEST
11	SRT, urgent refresh, XPT, or VCPT
10	Cache/DEA request, urgent packet transfer
01	High-priority packet transfer
00	Low-priority packet transfer, trickle refresh, idle

device reset

The SMJ320C80 is reset when the $\overline{\text{RESET}}$ input is driven low. The 'C80 outputs immediately go into a high-impedance state with the exception of CLKOUT, $\overline{\text{HACK}}$, and REQ[1:0]. While $\overline{\text{RESET}}$ is low, all internal registers are set to their default values and internal logic is reset.

On the rising edge of $\overline{\text{RESET}}$, the state of $\overline{\text{UTIME}}$ is sampled to determine if big-endian ($\overline{\text{UTIME}} = 0$) or little-endian ($\overline{\text{UTIME}} = 1$) operation is selected. Also, on the rising edge of $\overline{\text{RESET}}$, the state of $\overline{\text{HREQ}}$ is sampled to determine if the master processor comes up running ($\overline{\text{HREQ}} = 0$) or halted ($\overline{\text{HREQ}} = 1$).

Once $\overline{\text{RESET}}$ is high, the 'C80 drives the high-impedance signals to their inactive values. The TC then performs 32 refresh cycles to initialize system memory. If, during initialization refresh, the TC receives an SDRAM cycle timing code (CT = 0xx), it performs an SDRAM DCAB cycle and a MRS cycle to initialize the SDRAM, and then continues the refresh cycles.

After completing initialization refresh, if the MP is running, the TC performs its instruction-cache-fill request to fetch the cache block beginning at 0xFFFFF0. This block contains the starting MP instruction located at 0xFFFFF8. If the MP comes up halted, the instruction cache fill does not take place until the first occurrence of an EINT3 interrupt to unhalt the MP.

absolute maximum ratings over specified temperature ranges (unless otherwise noted)[†]

Supply voltage range, V_{DD} (see Note 1)	-0.3 V to 4 V
Input voltage range, V_I	-0.3 V to 4 V
Output voltage range	-0.3 V to 4 V
Case temperature, T_C (M-temperature)	-55°C to 125°C
(A-temperature)	-40°C to 85°C
Storage temperature range, T_{stg}	-55°C to 150°C

[†] Stresses beyond those listed under “absolute maximum ratings” may cause permanent damage to the device. These are stress ratings only, and functional operation of the device at these or any other conditions beyond those indicated under “recommended operating conditions” is not implied. Exposure to absolute-maximum-rated conditions for extended periods may affect device reliability.

NOTE 1: All voltage values are with respect to V_{SS} .

recommended operating conditions

		MIN	NOM	MAX	UNIT
V_{DD}	Supply voltage	3.135	3.3	3.465	V
V_{SS}	Supply voltage (see Note 2)	0	0	0	V
I_{OH}	High-level output current			-400	μA
I_{OL}	Low-level output current			2	mA
T_C	Case temperature	M-temperature		125	°C
		A-temperature	-40	85	

NOTE 2: To minimize noise on V_{SS} , care should be taken to provide a minimum inductance path between the V_{SS} pins and system ground.

electrical characteristics over recommended range of supply voltage and specified temperature (unless otherwise noted)

PARAMETER	TEST CONDITIONS [‡]	MIN	TYP [§]	MAX	UNIT
V_{IH}	High-level input voltage	2	$V_{DD} + 0.3$		V
V_{IL}	Low-level input voltage	-0.3		0.8	V
V_{OH}	High-level output voltage	$V_{DD} = \text{MIN}, I_{OH} = \text{MAX}$	2.2		V
V_{OL}	Low-level output voltage	$V_{DD} = \text{MAX}$		0.8	V
I_O	Output current, leakage (high impedance) (except EMU0 and EMU1)	$V_{DD} = \text{MAX}, V_O = 2.8 \text{ V}$		20	μA
		$V_{DD} = \text{MAX}, V_O = 0.6 \text{ V}$		-20	
I_I	Input current (except TCK, TDI, and TMS), TRST	$V_I = V_{SS} \text{ to } V_{DD}$		±20	μA
I_{DD}	Supply current (see Note 3)	$V_{DD} = \text{MAX}, 50 \text{ MHz}$	1 [§]	2.5	A
C_i	Input capacitance		10 [§]		pF
C_o	Output capacitance		10 [§]		pF

[‡] For conditions shown as MIN/MAX, use the appropriate value specified under the recommended operating conditions.

[§] All typical values are at $V_{DD} = 3.3 \text{ V}, T_A = 25^\circ\text{C}$

[¶] Typical steady-state V_{OH} will not exceed V_{DD}

NOTE 3: Maximum supply current is derived from a test case that generates the theoretical maximum data flow using a worst case checkerboard data pattern on a sustained cycle by cycle basis. Actual maximum I_{DD} varies in real applications based on internal and external data flow and transitions. Typical supply current is derived from a test case which attempts to emulate typical use conditions of the on-chip processors with random data. Typical I_{DD} varies from application to application based on data flow and transitions and on-chip processor utilization.

PARAMETER MEASUREMENT INFORMATION

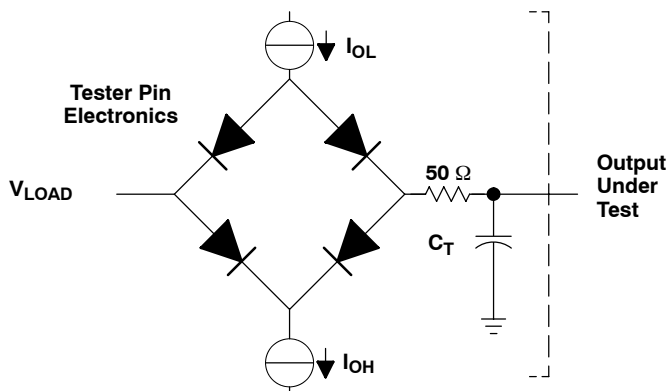

Where: I_{OL} = 2.0 mA (all outputs)
 I_{OH} = 400 μ A (all outputs)
 V_{LOAD} = 1.5 V
 C_T = 60 pF typical load circuit capacitance

Figure 105. Test Load Circuit

signal transition levels

TTL-output levels are driven to a minimum logic-high level of 2.2 V and to a maximum logic-low level of 0.8 V. Figure 106 shows the TTL-level outputs.

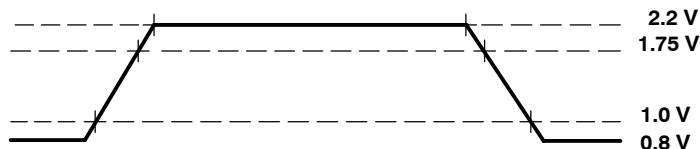

Figure 106. TTL-Level Outputs

TTL-output transition times are specified as follows:

- For a high-to-low transition, the level at which the output is said to be no longer high is 1.75 V, and the level at which the output is said to be low is 1.0 V.
- For a low-to-high transition, the level at which the output is said to be no longer low is 1.0 V, and the level at which the output is said to be high is 1.75 V.

Figure 107 shows the TTL-level inputs.

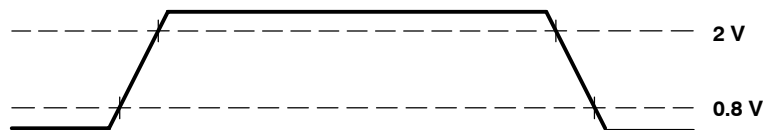

Figure 107. TTL-Level Inputs

TTL-compatible input transition times are specified as follows:

- For a high-to-low transition on an input signal, the level at which the input is said to be no longer high is 2 V, and the level at which the input is said to be low is 0.8 V.
- For a low-to-high transition on an input signal, the level at which the input is said to be no longer low is 0.8 V, and the level at which the input is said to be high is 2 V.

PARAMETER MEASUREMENT INFORMATION

timing parameter symbology

Timing parameter symbols used herein were created in accordance with JEDEC Standard 100-A. In order to shorten the symbols, some of the pin names and other related terminology have been abbreviated as follows:

A	A[31:0]	RDY	READY
CAS	$\overline{\text{CAS}}/\text{DQM}[7:0]$	RST	$\overline{\text{RESET}}$
CFG	AS[2:0], BS[1:0], CT[2:0], PS[3:0], $\overline{\text{UTIME}}$	RTY	$\overline{\text{RETRY}}$
CKI	CLKIN	REQ	REQ[1:0]
CKO	CLKOUT	RL	$\overline{\text{RL}}$
CMP	$\overline{\text{RETRY}}$, READY, $\overline{\text{FAULT}}$	RR	READY, $\overline{\text{RETRY}}$
D	D[63:0]	SCK	SCLK0, SCLK1
EIN	$\overline{\text{EINT1}}$, $\overline{\text{EINT2}}$, $\overline{\text{EINT3}}$, or EINTx	TCK	TCK
EMU	EMU0, EMU1	TDI	TDI
FCK	FCLK0, FCLK1	TDO	TDO
HAK	$\overline{\text{HACK}}$	TMS	TMS
HRQ	$\overline{\text{HREQ}}$	TRS	$\overline{\text{TRST}}$
LIN	$\overline{\text{LINT4}}$	UTM	$\overline{\text{UTIME}}$
MID	A[31:0], STATUS[5:0]	SI	$\overline{\text{HSYNC0}}$, $\overline{\text{VSYNC0}}$, $\overline{\text{CSYNC0}}$, $\overline{\text{HSYNC1}}$, $\overline{\text{VSYNC1}}$, or $\overline{\text{CSYNC1}}$
OUT	A[31:0], $\overline{\text{CAS}}/\text{DQM}[7:0]$, D[63:0], $\overline{\text{DBEN}}$, $\overline{\text{DDIN}}$, DSF, $\overline{\text{RAS}}$, $\overline{\text{RL}}$, STATUS[5:0], $\overline{\text{TRG}}/\text{CAS}$, $\overline{\text{W}}$	SY	$\overline{\text{HSYNC0}}$, $\overline{\text{VSYNC0}}$, $\overline{\text{CSYNC0}}/\text{HBLNK0}$, $\overline{\text{CBLNK0}}/\text{VBLNK0}$, $\overline{\text{HSYNC1}}$, $\overline{\text{VSYNC1}}$, $\overline{\text{CSYNC1}}/\text{HBLNK1}$, $\overline{\text{CBLNK1}}/\text{VBLNK1}$, CAREA0, or CAREA1
RAS	$\overline{\text{RAS}}$	XPT	XPT[2:0] OR $\overline{\text{XPTx}}$

Lowercase subscripts and their meanings are:

a	access time
c	cycle time (period)
d	delay time
h	hold time
su	setup time
t	transition time
w	pulse duration (width)

The following letters and symbols and their meanings are:

H	High
L	Low
V	Valid
Z	High impedance
X	Unknown, changing, or don't care level

SMJ320C80 DIGITAL SIGNAL PROCESSOR

SGUS025A - AUGUST 1998 - REVISED JUNE 2002

general notes on timing parameters

The period of the output clock (CLKOUT) is twice the period of the input clock (CLKIN), or $2 \times t_{c(CKI)}$. The half cycle time (t_H) that appears in the following tables is one-half of the output clock period, or equal to the input clock period, $t_{c(CKI)}$.

All output signals from the 'C80 (including CLKOUT) are derived from an internal clock such that all output transitions for a given half cycle occur with a minimum of skewing relative to each other.

The signal combinations shown in the following timing diagrams may not necessarily represent actual cycles. For actual cycle examples, refer to the appropriate cycle description section of this data sheet.

CLKIN timing requirements (see Figure 108)

NO	PARAMETER	MIN	MAX	UNIT
1	$t_{c(CKI)}$ Period of CLKIN (t_H)	10		ns
2	$t_{w(CKIH)}$ Pulse duration of CLKIN high	4.2		ns
3	$t_{w(CKIL)}$ Pulse duration of CLKIN low	4.2		ns
4	$t_t(CKI)$ Transition time of CLKIN		1.5*	ns

* This parameter is not production tested.

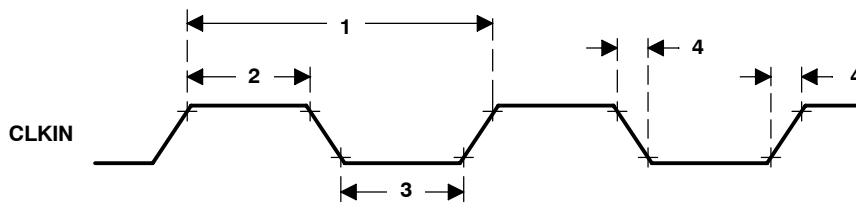

Figure 108. CLKIN Timing

local-bus switching characteristics over full operating range: CLKOUT† (see Figure 109)

NO	PARAMETER	MIN	MAX	UNIT
5	$t_{c(CKO)}$ Period of CLKOUT	$2t_{c(CKI)}^{\ddagger*}$		ns
6	$t_{w(CKOH)}$ Pulse duration of CLKOUT high	$t_H - 4.5$		ns
7	$t_{w(CKOL)}$ Pulse duration of CLKOUT low	$t_H - 4.5$		ns
8	$t_t(CKO)$ Transition time of CLKOUT		2.5*	ns

† The CLKOUT output has twice the period of CLKIN. No propagation delay or phase relationship to CLKIN is ensured. Each state of a memory access begins on the falling edge of CLKOUT.

‡ This parameter can also be specified as $2t_H$.

* This parameter is not production tested.

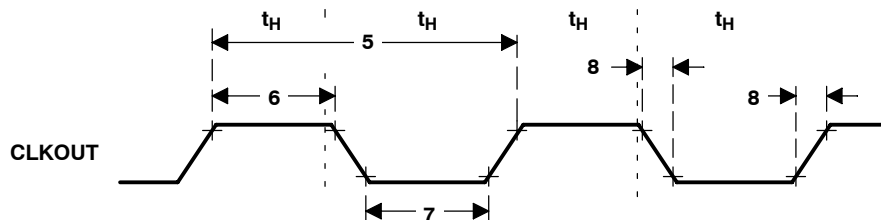

Figure 109. CLKOUT Timing

device reset timing requirements (see Figure 110)

NO			MIN	MAX	UNIT
9	$t_{w(RSTL)}$	Pulse duration, \overline{RESET} low	Initial reset during power-up	$6t_h$	ns
			Reset during active operation	$6t_h$	ns
10	$t_{su(HRQL-RSTH)}$	Setup time of \overline{HREQ} low to \overline{RESET} high to configure self-bootstrap mode	$4t_h$		ns
11	$t_h(RSTH-HRQL)$	Hold time, \overline{HREQ} low after \overline{RESET} high to configure self-bootstrap mode	0		ns
12	$t_{su(UTML-RSTH)}$	Setup time of \overline{UTIME} low to \overline{RESET} high to configure big-endian operation	$4t_h$		ns
13	$t_h(RSTH-UTML)$	Hold time, \overline{UTIME} low after \overline{RESET} high to configure big-endian operation	0		ns

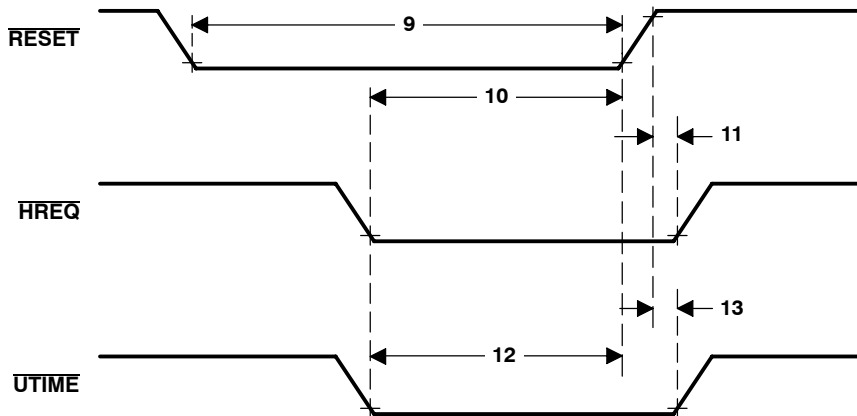

Figure 110. Device-Reset Timing

SMJ320C80 DIGITAL SIGNAL PROCESSOR

SGUS025A - AUGUST 1998 - REVISED JUNE 2002

local bus timing requirements: cycle configuration inputs (see Figure 111)

The cycle configuration inputs are sampled at the beginning of each row access during the r2 state. The inputs typically are generated by a static decode of the A[31:0] and STATUS[5:0] outputs.

NO		MIN	MAX	UNIT
14	$t_{su(CFGV-CKOH)}$ Setup time, AS, BS, CT, PS, and \overline{UTIME} valid to CLKOUT no longer low	8		ns
15	$t_{h(CKOH-CFGV)}$ Hold time, AS, BS, CT, PS, and \overline{UTIME} valid after CLKOUT high	2		ns
16	$t_a(MIDV-CFGV)$ Access time, AS, BS, CT, PS, and \overline{UTIME} valid after memory identification (A, STATUS) valid	$3t_H - 10$		ns

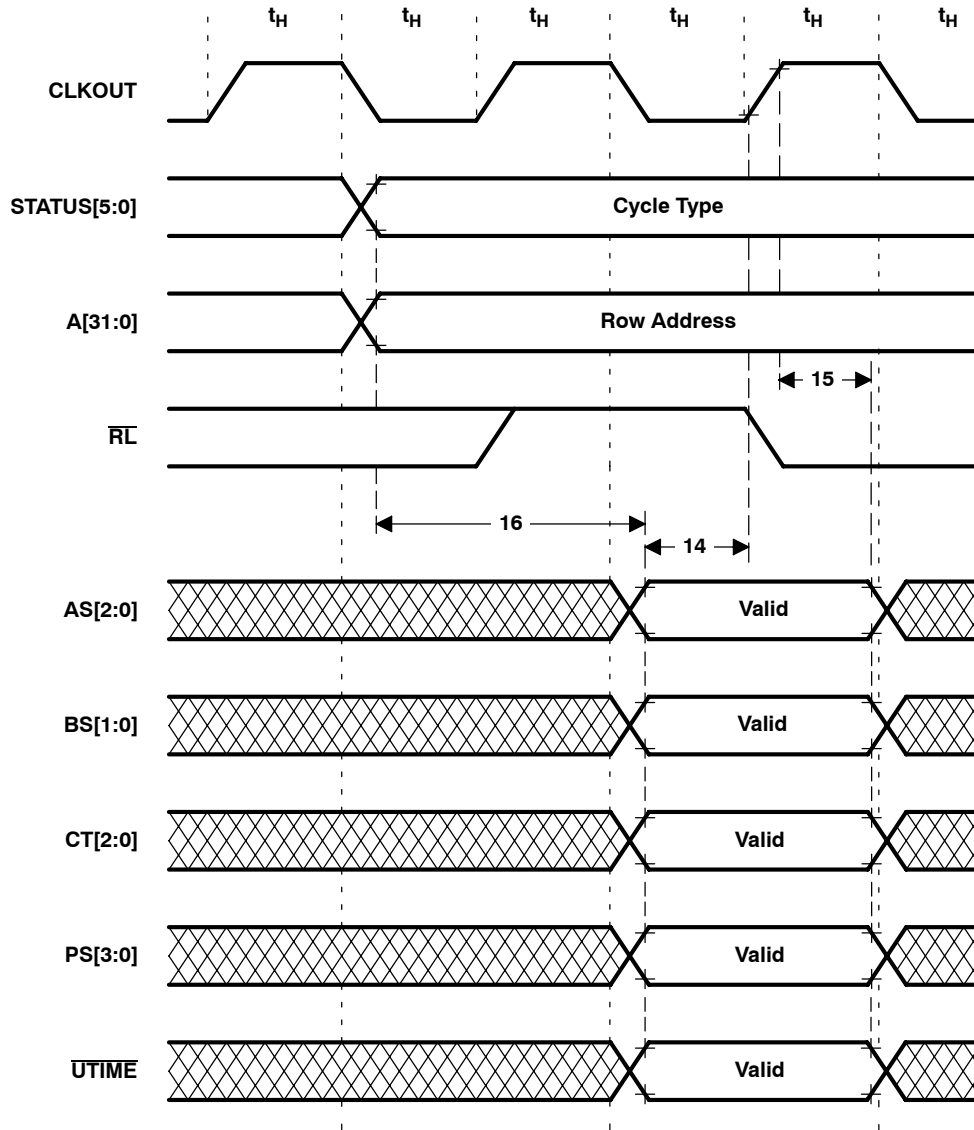

Figure 111. Local Bus Timing: Cycle Configuration Inputs

local bus timing: cycle completion inputs (see Figure 112 and Figure 113)

The cycle completion inputs are sampled at the beginning of each row access at the start of the r3 state. The READY input is sampled also at the start of the r6 state and during each column access (2 and 3 cyc/col accesses only). The $\overline{\text{RETRY}}$ input is sampled on each CLKOUT falling edge following r3. The value n as used in the parameters represents the integral number of half cycles between the transitions of the two signals in question.

NO		MIN	MAX	UNIT
17	$t_{a(\text{MIDV-CMPV})}$ Access time, $\overline{\text{RETRY}}$, READY, FAULT valid after memory identification (A, STATUS) valid		nt_H-8	ns
18	$t_{su(\text{CMPV-CKOL})}$ Setup time, $\overline{\text{RETRY}}$, READY, FAULT valid to CLKOUT no longer high	7.5		ns
19	$t_{h(\text{CKOL-CMPV})}$ Hold time, $\overline{\text{RETRY}}$, READY, FAULT valid after CLKOUT low	1.2		ns
20	$t_{a(\text{RASL-RRV})}$ Access time $\overline{\text{RETRY}}$, READY valid from $\overline{\text{RAS}}$ low		$nt_H-7.5$	ns
21	$t_{a(\text{RLL-RRV})}$ Access time, $\overline{\text{RETRY}}$, READY valid from $\overline{\text{RL}}$ low		$nt_H-7.5$	ns
22	$t_{a(\text{CASL-RRV})}$ Access time, READY valid from $\overline{\text{CAS}}$ low	2 cyc/col accesses	t_H-12	ns
		3 cyc/col accesses	$2t_H-8$	

local bus timing: cycle completion inputs (continued)

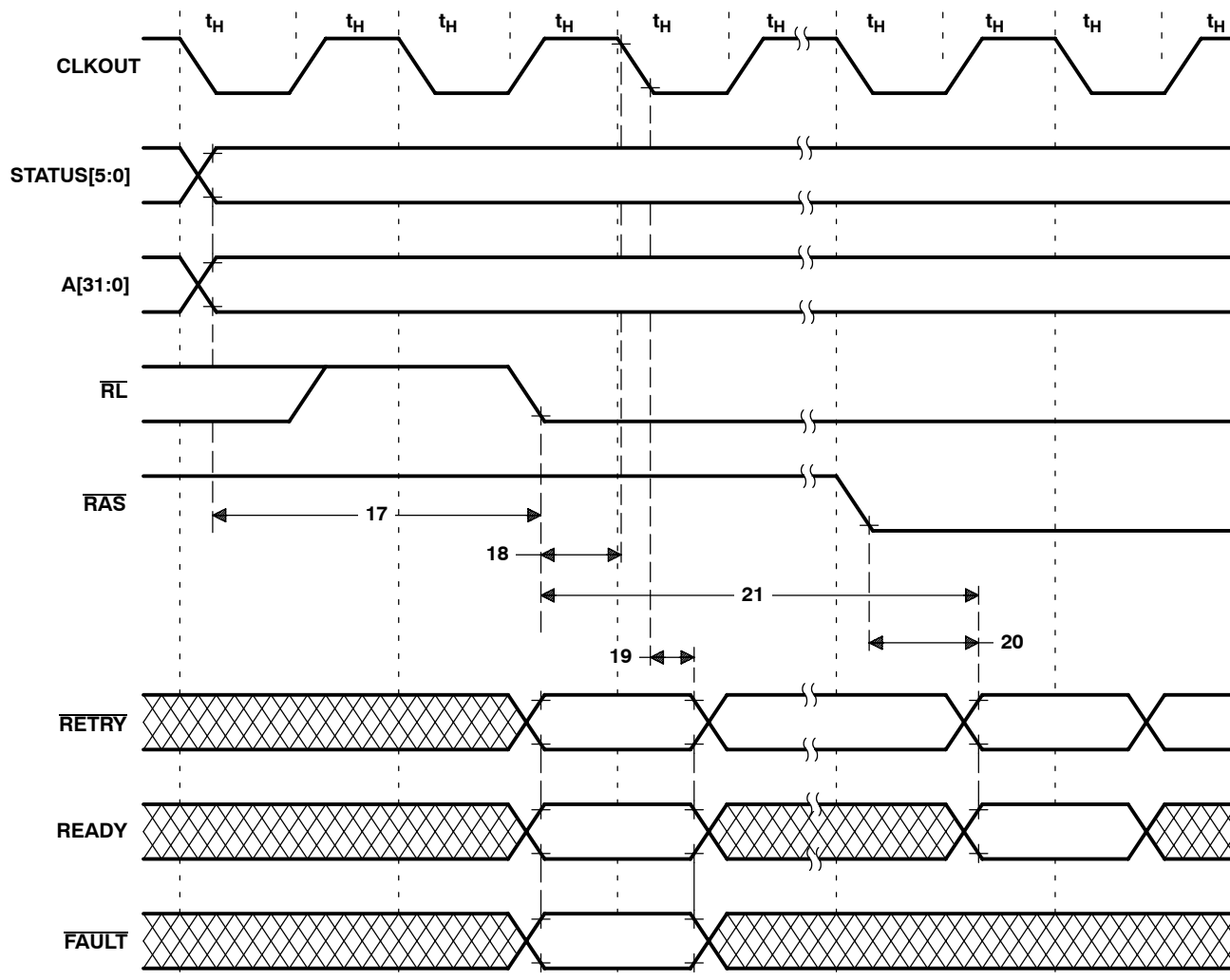

Figure 112. Local Bus Timing: Row-Time Cycle Completion Inputs

local bus timing: cycle completion inputs (continued)

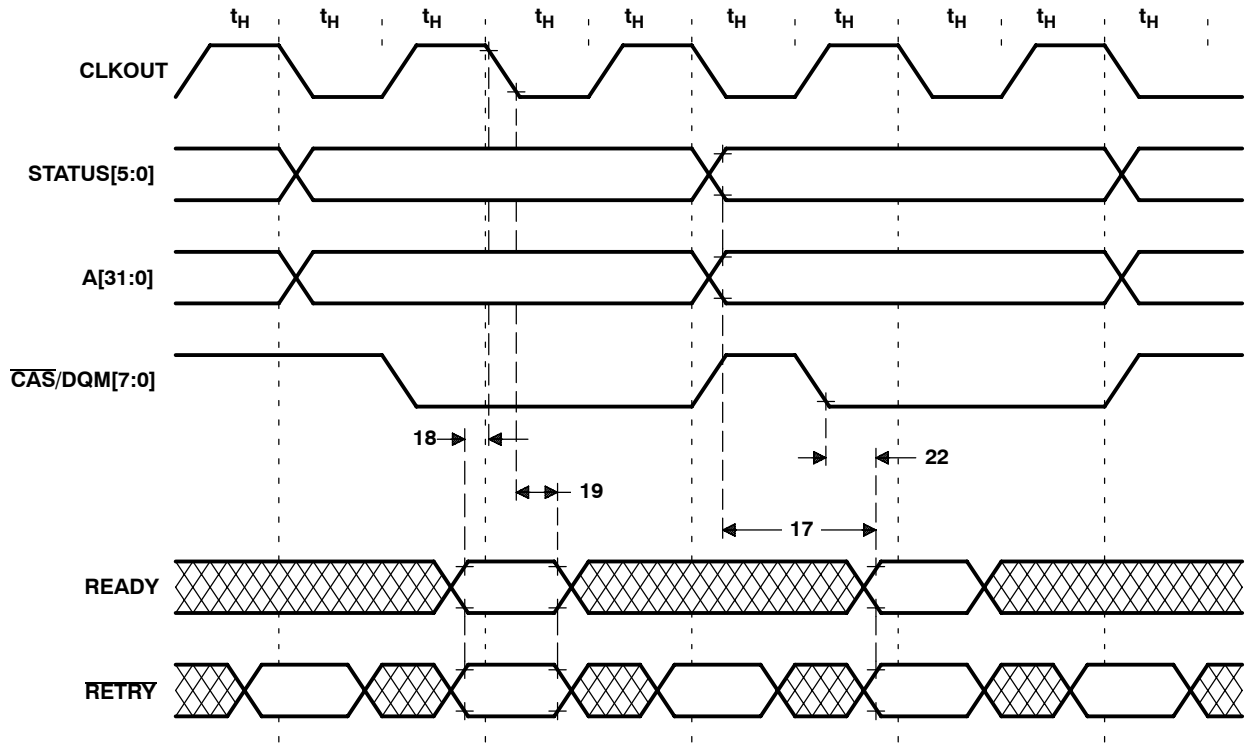

Figure 113. Local Bus Timing: Column-Time Cycle Completion Inputs

SMJ320C80 DIGITAL SIGNAL PROCESSOR

SGUS025A - AUGUST 1998 - REVISED JUNE 2002

general output signal characteristics over operating conditions

The following general timing parameters apply to all SMJ320C80 output signals unless otherwise specifically given. The value n as used in the parameters represents the integral number of half cycles between the transitions of the two outputs in question. For timing purposes, outputs fall into one of three groups - the data bus (D[63:0]); the other output buses (A[31:0], STATUS[5:0], $\overline{\text{CAS}}/\text{DQM}[7:0]$; and non-bus outputs ($\overline{\text{DBEN}}$, $\overline{\text{RL}}$, $\overline{\text{DDIN}}$, $\overline{\text{DSF}}$, $\overline{\text{RAS}}$, $\overline{\text{TRG}}/\overline{\text{CAS}}$, $\overline{\text{W}}$). When measuring output to output, the named group refers to the second output to transition (output B), and the first output (output A) refers to any output group.

NO	PARAMETER	MIN	MAX	UNIT
23	$t_{h(\text{OUTV-CKOL})}$ Hold time, CLKOUT high after output valid D[63:0] A[31:0], STATUS[5:0], $\overline{\text{CAS}}/\overline{\text{DQM}}[7:0]$ $\overline{\text{DBEN}}$, $\overline{\text{DDIN}}$, $\overline{\text{DSF}}$, $\overline{\text{RAS}}$, $\overline{\text{TRG}}/\overline{\text{CAS}}$, $\overline{\text{W}}$, $\overline{\text{RL}}$	$nt_H-5.6$ $nt_H-5.0^\dagger$ $nt_H-4.3$		ns
24	$t_{h(\text{OUTV-CKOH})}$ Hold time, CLKOUT low after output valid D[63:0] A[31:0], STATUS[5:0], $\overline{\text{CAS}}/\overline{\text{DQM}}[7:0]$ $\overline{\text{DBEN}}$, $\overline{\text{DDIN}}$, $\overline{\text{DSF}}$, $\overline{\text{RAS}}$, $\overline{\text{TRG}}/\overline{\text{CAS}}$, $\overline{\text{W}}$, $\overline{\text{RL}}$	$nt_H-5.6$ $nt_H-5.0^\dagger$ $nt_H-4.3$		ns
25	$t_{h(\text{CKOL-OUTV})}$ Hold time, output valid after CLKOUT low	$nt_H-5.5$		ns
26	$t_{h(\text{CKOH-OUTV})}$ Hold time, output valid after CLKOUT high	nt_H-5		ns
27	$t_{h(\text{OUTV-OUTV})}$ Hold time, output valid after output valid D[63:0] A[31:0], STATUS[5:0], $\overline{\text{CAS}}/\overline{\text{DQM}}[7:0]$ $\overline{\text{DBEN}}$, $\overline{\text{DDIN}}$, $\overline{\text{DSF}}$, $\overline{\text{RAS}}$, $\overline{\text{TRG}}/\overline{\text{CAS}}$, $\overline{\text{W}}$, $\overline{\text{RL}}$	$nt_H-6.5$ $nt_H-6.0^\dagger$ nt_H-5		ns
28	$t_{d(\text{CKOH-OUTV})}$ Delay time, CLKOUT no longer low to output valid D[63:0] A[31:0], STATUS[5:0], $\overline{\text{CAS}}/\overline{\text{DQM}}[7:0]$ $\overline{\text{DBEN}}$, $\overline{\text{DDIN}}$, $\overline{\text{DSF}}$, $\overline{\text{RAS}}$, $\overline{\text{TRG}}/\overline{\text{CAS}}$, $\overline{\text{W}}$, $\overline{\text{RL}}$		$nt_H+6.5$ $nt_H+5.5^\dagger$ nt_H+5	ns
29	$t_{d(\text{CKOL-OUTV})}$ Delay time, CLKOUT no longer high to output valid D[63:0] A[31:0], STATUS[5:0], $\overline{\text{CAS}}/\overline{\text{DQM}}[7:0]$ $\overline{\text{DBEN}}$, $\overline{\text{DDIN}}$, $\overline{\text{DSF}}$, $\overline{\text{RAS}}$, $\overline{\text{TRG}}/\overline{\text{CAS}}$, $\overline{\text{W}}$, $\overline{\text{RL}}$		$nt_H+6.5$ $nt_H+5.5^\dagger$ nt_H+5	ns
30	$t_{d(\text{OUTV-CKOH})}$ Delay time, output no longer valid to CLKOUT high		nt_H+5	ns
31	$t_{d(\text{OUTV-CKOL})}$ Delay time, output no longer valid to CLKOUT low		$nt_H+5.5$	ns
32	$t_{d(\text{OUTV-OUTV})}$ Delay time, output no longer valid to output valid D[63:0] A[31:0], STATUS[5:0], $\overline{\text{CAS}}/\overline{\text{DQM}}[7:0]$ $\overline{\text{DBEN}}$, $\overline{\text{DDIN}}$, $\overline{\text{DSF}}$, $\overline{\text{RAS}}$, $\overline{\text{TRG}}/\overline{\text{CAS}}$, $\overline{\text{W}}$, $\overline{\text{RL}}$		$nt_H+6.5$ $nt_H+6.0^\dagger$ nt_H+5	ns
33	$t_w(\text{OUTV})$ Pulse duration, output valid D[63:0] A[31:0], STATUS[5:0], $\overline{\text{CAS}}/\overline{\text{DQM}}[7:0]$ $\overline{\text{DBEN}}$, $\overline{\text{DDIN}}$, $\overline{\text{DSF}}$, $\overline{\text{RAS}}$, $\overline{\text{TRG}}/\overline{\text{CAS}}$, $\overline{\text{W}}$, $\overline{\text{RL}}$	$nt_H-6.5$ $nt_H-6.0^\dagger$ $nt_H-5.0$		ns

[†] Except for $\overline{\text{CAS}}/\overline{\text{DQM}}[7:0]$ during nonuser-timed 2-cycle/column accesses



general output signal characteristics over operating conditions (continued)

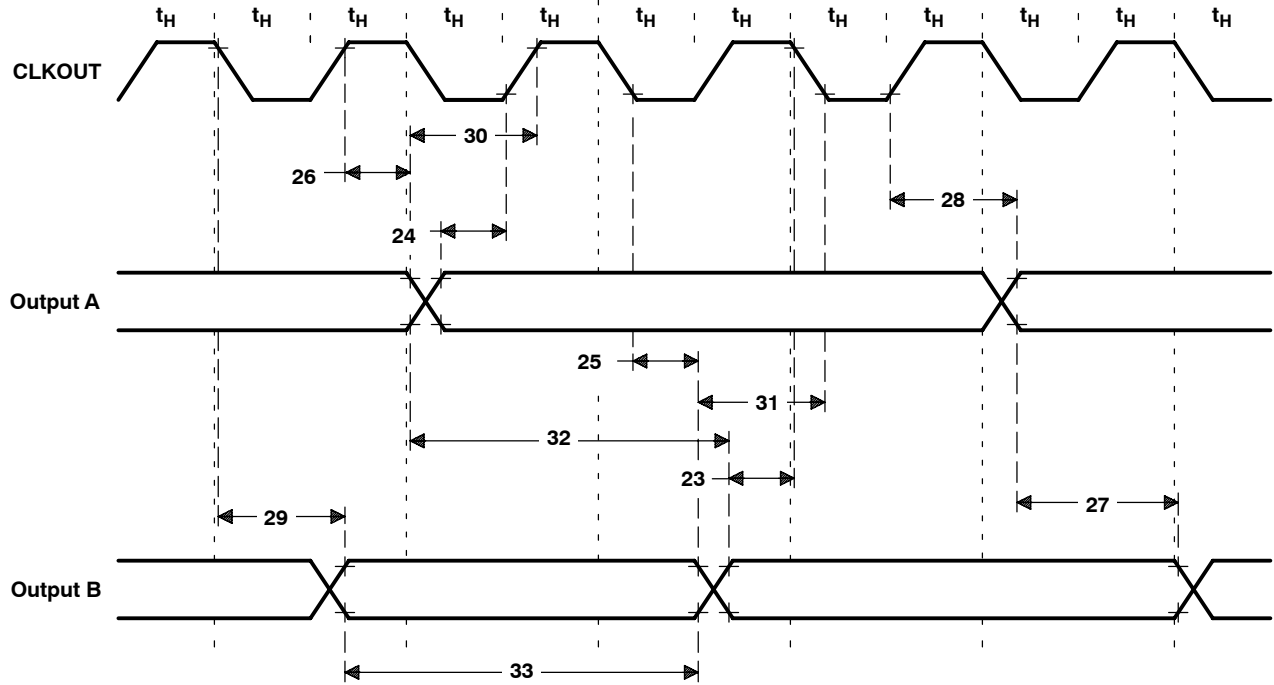

Figure 114. General Output-Signal Timing

SMJ320C80 DIGITAL SIGNAL PROCESSOR

SGUS025A - AUGUST 1998 - REVISED JUNE 2002

data input timing (see Figure 115)

The following general timing parameters apply to the D[63:0] inputs unless otherwise specifically given. The value n as used in the parameters represents the integral number of half cycles between the transitions of the output and input in question.

NO	PARAMETER	MIN	MAX	UNIT
34	$t_{a(CKOH-DV)}$ Access time, CLKOUT high to D[63:0] valid		$nt_H - 5.3$	ns
35	$t_{a(CKOL-DV)}$ Access time, CLKOUT low to D[63:0] valid		$nt_H - 6.5$	ns
36	$t_{su(DV-CKOH)}$ Setup time, D[63:0] valid to CLKOUT no longer low	6.1		ns
37	$t_{su(DV-CKOL)}$ Setup time, D[63:0] valid to CLKOUT no longer high	6.1		ns
38	$t_h(CKOL-DV)$ Hold time, D[63:0] valid after CLKOUT low	2		ns
39	$t_h(CKOH-DV)$ Hold time, D[63:0] valid after CLKOUT high	2		ns
40	$t_{a(OUTV-DV)}$ Access time, output valid to D[63:0] inputs valid A[31:0], $\overline{CAS}/DQM[7:0]^\dagger$, STATUS[5:0], \overline{RL} , \overline{DBEN} , \overline{DDIN} , \overline{DSF} , \overline{RAS} , \overline{RL} , $\overline{TRG}/\overline{CAS}$, \overline{W}		$nt_H - 7$ $nt_H - 6.5$	ns
41	$t_h(OUTV-DV)^\ddagger$ Hold time, D[63:0] valid after output valid \overline{RAS} , $\overline{CAS}/DQM[7:0]$, A[31:0]	3		ns

[†] Except $\overline{CAS}/DQM[7:0]$ during nonuser-timed 2-cycle/column accesses

[‡] Applies to \overline{RAS} , $\overline{CAS}/DQM[7:0]$, and A[31:0] transitions that occur on CLKOUT edge coincident with input data sampling

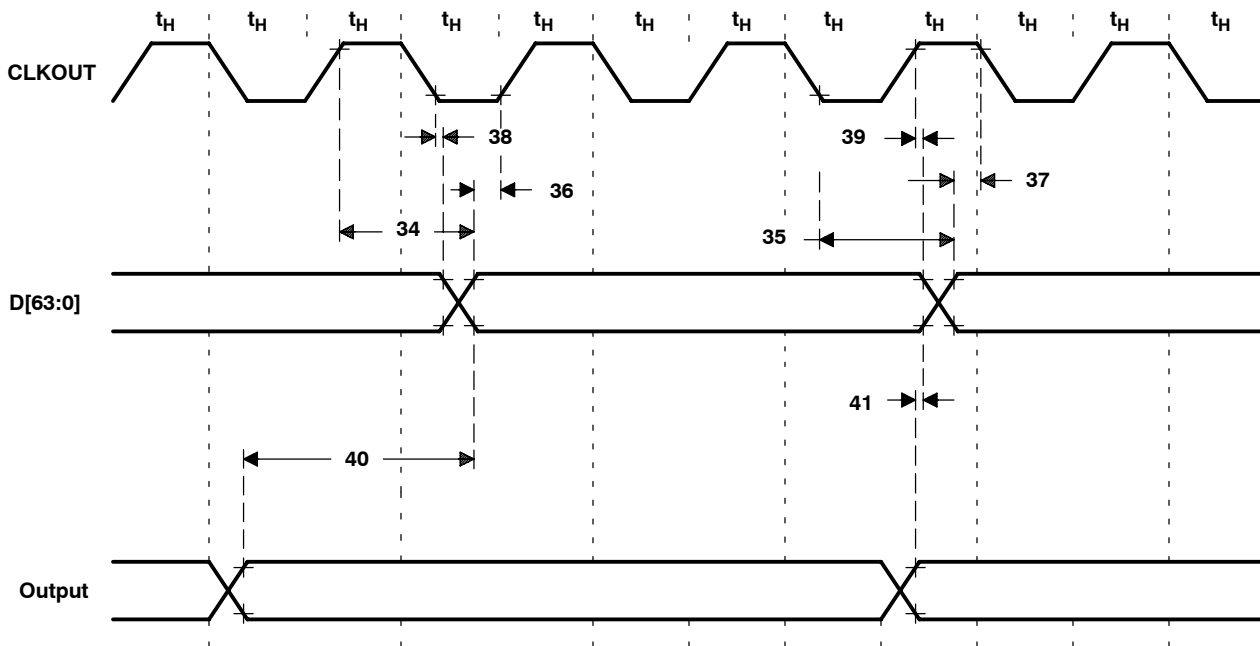

Figure 115. Data-Input Timing

local bus timing: 2-cycle/column $\overline{\text{CAS}}$ timing

These timing parameters apply to the $\overline{\text{CAS}}/\text{DQM}[7:0]$ signals during 2-cycle-per-column memory accesses only. They should be used in place of the general output and data input timing parameters when the 2-cycle/column (nonuser-timed) cycle timing is selected (CT[2:0] inputs = 0b110). The value n as used in the parameters represents the integral number of half cycles between the transitions of the signals in question.

NO		MIN	MAX	UNIT
42	$t_{w(\text{CASH})}$ Pulse duration, $\overline{\text{CAS}}/\text{DQM}$ high	t_H-2		ns
43	$t_{w(\text{CASL})}$ Pulse duration, $\overline{\text{CAS}}/\text{DQM}$ low	$3t_H-9.5$		ns
44	$t_{h(\text{OUTV-CASL})}$ Hold time, $\overline{\text{CAS}}/\text{DQM}$ high after output valid D[63:0] A[31:0], STATUS[5:0] $\overline{\text{DBEN}}$, $\overline{\text{DDIN}}$, $\overline{\text{DSF}}$, $\overline{\text{RAS}}$, $\overline{\text{RL}}$, $\overline{\text{TRG}}/\text{CAS}$, $\overline{\text{W}}$	$nt_H-4.5$ $nt_H-4.0$ nt_H-3		ns
45	$t_{h(\text{CASL-OUTV})}$ Hold time, output valid after $\overline{\text{CAS}}/\text{DQM}$ low	$nt_H-9.5$		ns
46	$t_{a(\text{CASL-DV})}$ Access time, data valid from $\overline{\text{CAS}}/\text{DQM}$ low		$3t_H-12$	ns
47	$t_{h(\text{CASH-DV})}$ Hold time, data valid after $\overline{\text{CAS}}/\text{DQM}$ high		2	ns

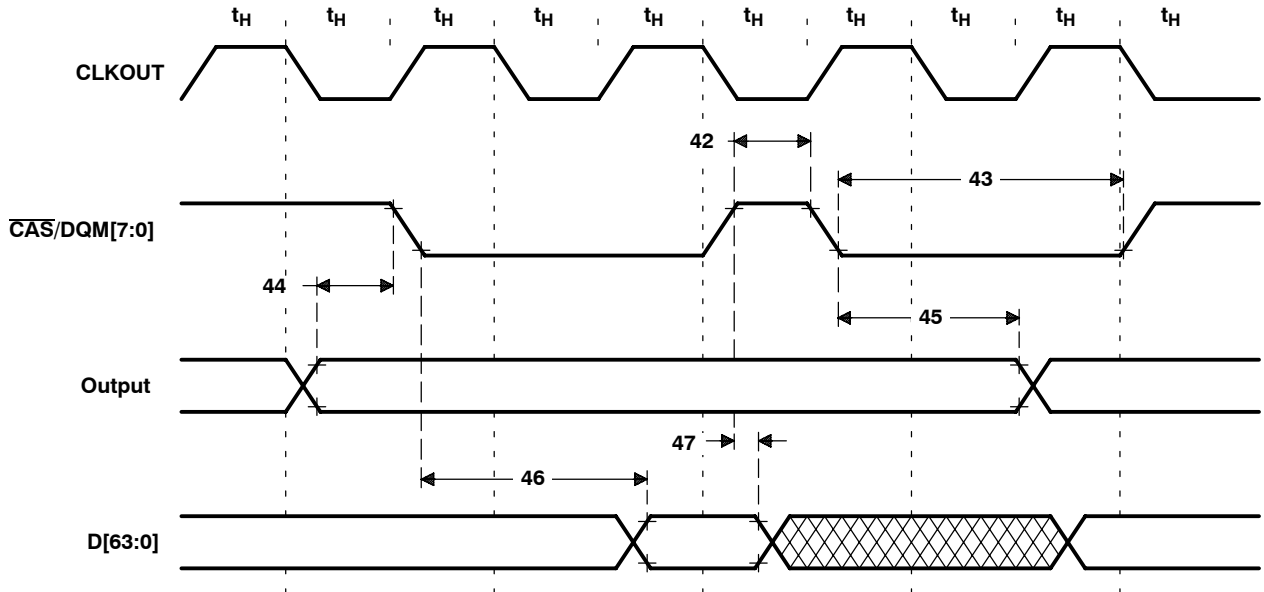

Figure 116. 2-Cycle/Column $\overline{\text{CAS}}$ Timing

SMJ320C80 DIGITAL SIGNAL PROCESSOR

SGUS025A - AUGUST 1998 - REVISED JUNE 2002

external interrupt timing (see Figure 117)

The following description defines the timing of the edge-triggered interrupts $\overline{EINT1}$ - $\overline{EINT3}$ and the level-triggered interrupt $\overline{LINT4}$ (see Note 4).

NO		MIN	MAX	UNIT
48	$t_w(\overline{EINTx})$ Pulse duration, \overline{EINTx} low	6*		ns
49	$t_{su}(\overline{EINTx}-\overline{CLKOUT})$ Setup time, \overline{EINTx} high before \overline{CLKOUT} no longer low	9.5†		ns
50	$t_w(\overline{EINTx})$ Pulse duration, \overline{EINTx} high	6*		ns
51	$t_{su}(\overline{LINT4}-\overline{CLKOUT})$ Setup time, $\overline{LINT4}$ low before \overline{CLKOUT} no longer high	9.5†		ns

† This parameter must only be met to ensure that the interrupt is recognized on the indicated cycle.

* This parameter is not production tested.

NOTE 4: In order to ensure recognition, $\overline{LINT4}$ must remain low until cleared by the interrupt service routine.

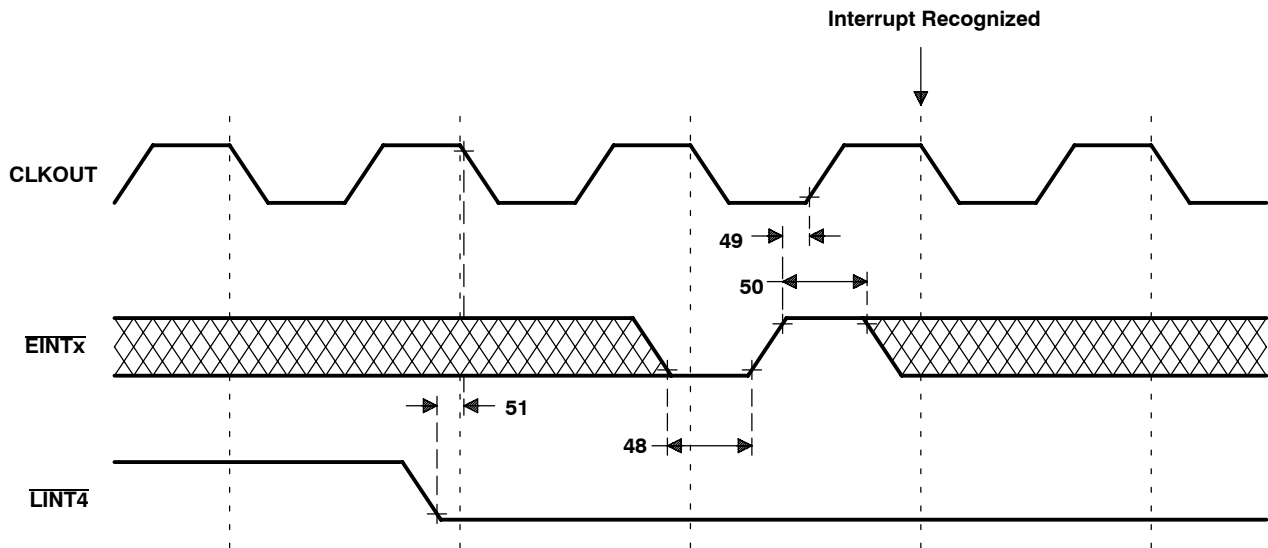

Figure 117. External Interrupt Timing

XPT input timing (see Figure 118 and Figure 119)

The following description defines the sampling of the $\overline{\text{XPT}}[2:0]$ inputs. The value encoded on the $\overline{\text{XPT}}[2:0]$ inputs is synchronized over multiple cycles to ensure that a stable value is present.

NO		MIN	MAX	UNIT
52	$t_{w(\text{XPTV})}$ Pulse duration, $\overline{\text{XPT}}\bar{x}$ valid	$12t_{\text{H}}^*$		ns
53	$t_{\text{su}(\text{XPTV-CKOH})}$ Setup time, $\overline{\text{XPT}}[2:0]$ valid before CLKOUT no longer low	12^\dagger		ns
54	$t_{\text{h}(\text{CKOH-XPTV})}$ Hold time, $\overline{\text{XPT}}[2:0]$ valid after CLKOUT high	5		ns
55	$t_{\text{h}(\text{RL-L-XPTV})}$ Hold time, $\overline{\text{XPT}}[2:0]$ valid after $\overline{\text{RL}}$ low	$6t_{\text{H}}^{\ddagger,*}$		ns

[†] This parameter must only be met to ensure that the XPT input is recognized on the indicated cycle.

[‡] This parameter must be met to ensure that a second XPT request does not occur.

* This parameter is not production tested.

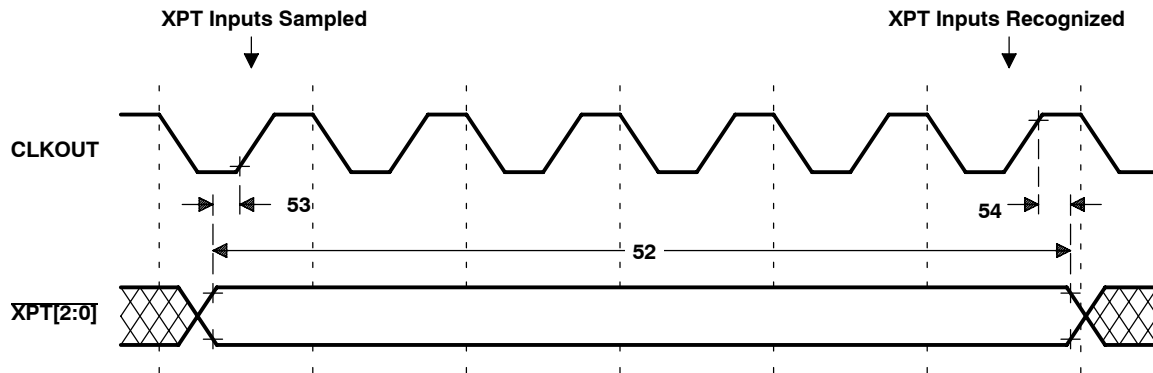

Figure 118. XPT Input Timing - XPT Recognition

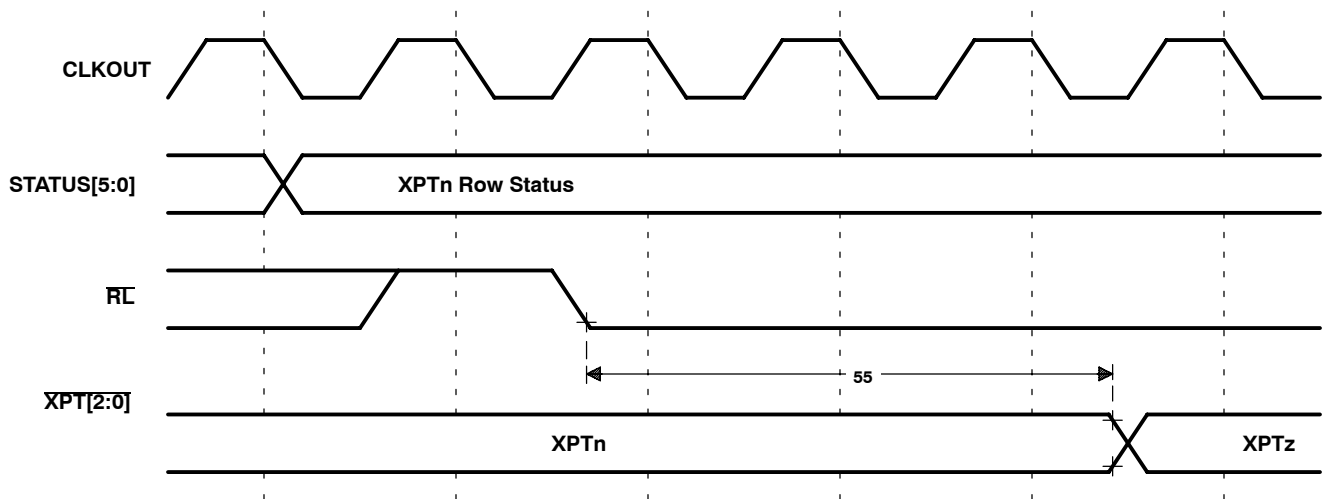

Figure 119. XPT Input Timing - XPT Service

SMJ320C80 DIGITAL SIGNAL PROCESSOR

SGUS025A - AUGUST 1998 - REVISED JUNE 2002

host-interface timing (see Figure 120)

NO		'C80-40		UNIT
		MIN	MAX	
56	$t_{su}(REQV-CKOH)$ Setup time, REQ1-REQ0 valid to CLKOUT no longer low	$t_H - 7$		ns
57	$t_h(CKOH-REQV)$ Hold time, REQ1-REQ0 valid after CLKOUT high	$t_H - 7$		ns
58	$t_h(HRQL-HAKL)$ Hold time for \overline{HACK} high after \overline{HREQ} goes low*	$4t_H - 12^*$		ns
59	$t_d(HAKL-OUTZ)$ Delay time, \overline{HACK} low to output hi-Z	All signals except D[63:0]	1*	ns
		D[63:0]	1*	
60	$t_d(HRQH-HAKH)$ Delay time, \overline{HREQ} high to \overline{HACK} no longer low		10	ns
61	$t_d(HAKH-OUTD)$ Delay time, \overline{HACK} high to outputs driven [†]	$6t_H$		
62	$t_{su}(HRQL-CKOH)$ Setup time, \overline{HREQ} low to CLKOUT no longer low (see Note 5)	8.5		ns

* This parameter is not production tested.

NOTE 5: Parameter must be met only to ensure \overline{HREQ} recognition during the indicated clock cycle.

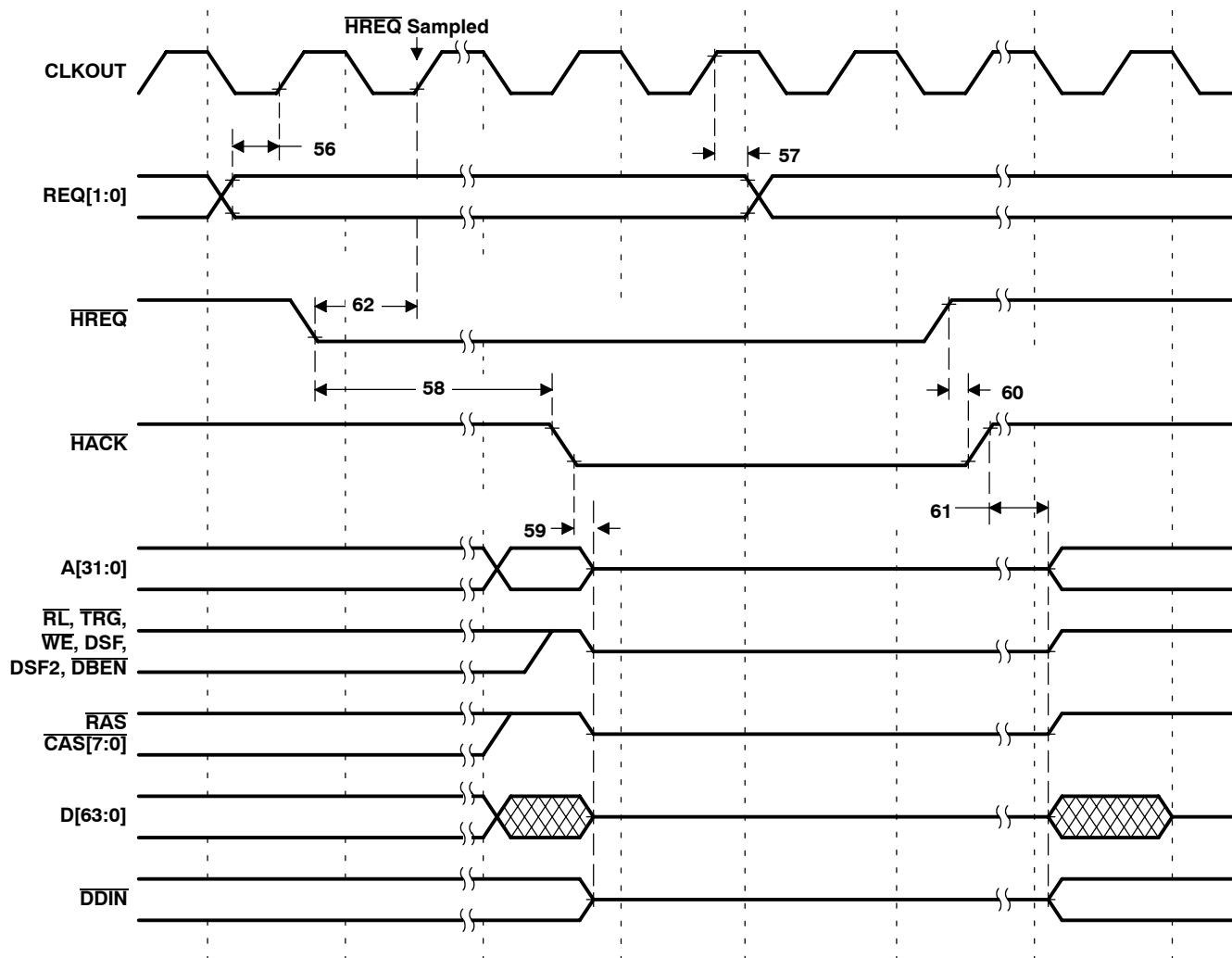

Figure 120. Host-Interface Timing



POST OFFICE BOX 1443 • HOUSTON, TEXAS 77251-1443

video interface timing: SCLK timing (see Figure 121)

NO		MIN	MAX	UNIT
63	$t_c(\text{SCK})$ SCLK period	13		ns
64	$t_w(\text{SCKH})$ Pulse duration, SCLK high	5		ns
65	$t_w(\text{SCKL})$ Pulse duration, SCLK low	5		ns
66	$t_t(\text{SCK})$ Transition time, SCLK (rise and fall)		2*	ns

* This parameter is not production tested.

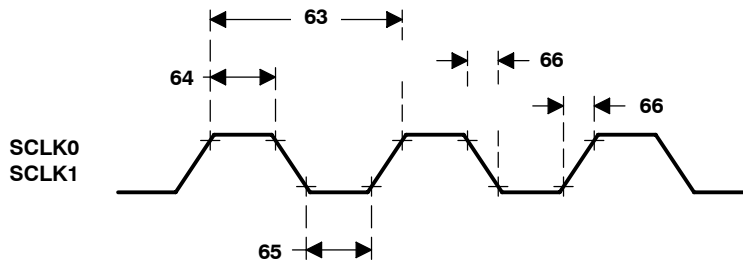

Figure 121. Video Interface Timing: SCLK Timing

SMJ320C80 DIGITAL SIGNAL PROCESSOR

SGUS025A - AUGUST 1998 - REVISED JUNE 2002

video interface timing: FCLK input and video outputs (see Note 6 and Figure 122)

NO		MIN	MAX	UNIT
67	$t_c(\text{FCK})$ FCLK period	25		ns
68	$t_w(\text{FCKH})$ Pulse duration, FCLK high	8		ns
69	$t_w(\text{FCKL})$ Pulse duration, FCLK low	8		ns
70	$t_t(\text{FCK})$ Transition time, FCLK (rise and fall)		2*	ns
71	$t_h(\text{FCKL-SYL})$ Hold time, HSYNC, VSYNC, CSYNC/HBLNK, CBLNK/VBLNK, or CAREA high after FCLK low	0		ns
72	$t_h(\text{FCKL-SYH})$ Hold time, HSYNC, VSYNC, CSYNC/HBLNK, CBLNK/VBLNK, or CAREA low after FCLK low	0		ns
73	$t_d(\text{FCKL-SYL})$ Delay time, FCLK no longer high to HSYNC, VSYNC, CSYNC/HBLNK, CBLNK/VBLNK, or CAREA low		20	ns
74	$t_d(\text{FCKL-SYH})$ Delay time, FCLK no longer high to HSYNC, VSYNC, CSYNC/HBLNK, CBLNK/VBLNK, or CAREA high		20	ns

* This parameter is not production tested.

NOTE 6: Under certain circumstances, these outputs also can transition asynchronously. These transitions occur when controller timing register values are modified by user programming. If the new register value forces the output to change states, then this transition occurs without regard to FCLK inputs.

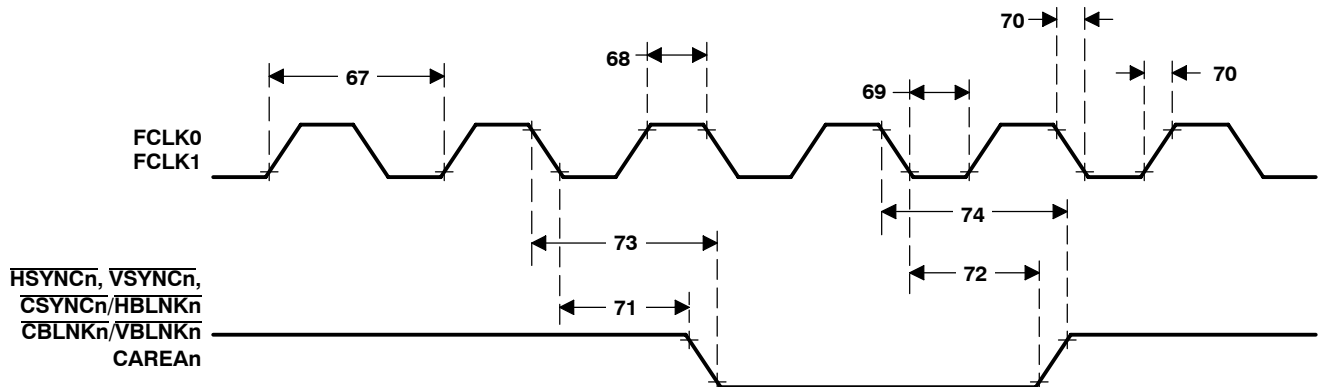

Figure 122. Video Interface Timing: FCLK Input and Video Outputs

video interface timing: external sync inputs (see Figure 123)

When configured as inputs, the $\overline{\text{HSYNCn}}$, $\overline{\text{VSYNCn}}$, and $\overline{\text{CSYNCn}}$ signals may be driven asynchronously. The following parameters apply only when the inputs are being generated synchronous to FCLKn in order to ensure recognition on a particular FLCKn edge.

NO		MIN	MAX	UNIT
75	$t_{su(\text{SIL-FCKH})}$ Setup time, $\overline{\text{HSYNC}}$, $\overline{\text{VSYNC}}$, or $\overline{\text{CSYNC}}$ low to FCLK no longer low [†]	5		ns
76	$t_{h(\text{FCKH-SIL})}$ Hold time, $\overline{\text{HSYNC}}$, $\overline{\text{VSYNC}}$, or $\overline{\text{CSYNC}}$ high after FCLK high [‡]	7		ns
77	$t_{su(\text{SIH-FCKH})}$ Setup time, $\overline{\text{HSYNC}}$, $\overline{\text{VSYNC}}$, or $\overline{\text{CSYNC}}$ high to FCLK no longer low [§]	5		ns
78	$t_{h(\text{FCKH-SIH})}$ Hold time, $\overline{\text{HSYNC}}$, $\overline{\text{VSYNC}}$, or $\overline{\text{CSYNC}}$ low after FCLK high [¶]	7		ns

[†] This parameter must be met only to ensure the input is recognized as low at FLCK edge B.

[‡] This parameter must be met only to ensure the input is recognized as high at FLCK edge A.

[§] This parameter must be met only to ensure the input is recognized as high at FLCK edge D.

[¶] This parameter must be met only to ensure the input is recognized as low at FLCK edge C.

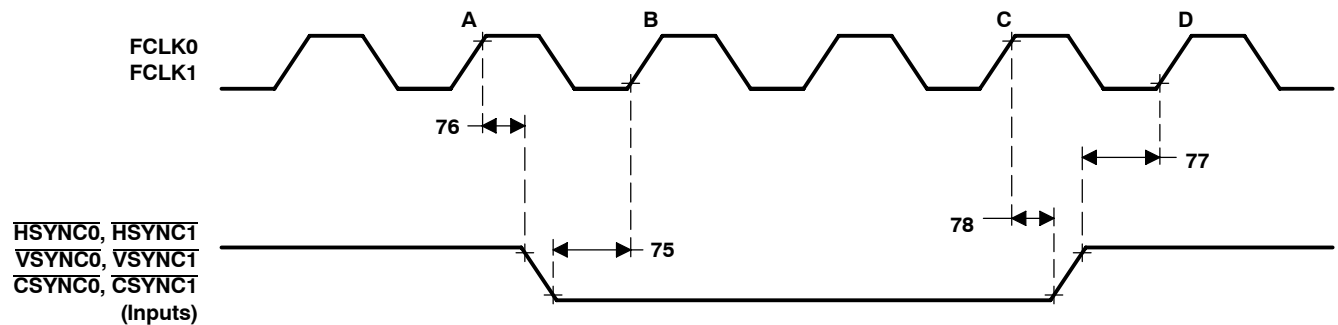

Figure 123. Video Interface Timing: External Sync Inputs

SMJ320C80 DIGITAL SIGNAL PROCESSOR

SGUS025A - AUGUST 1998 - REVISED JUNE 2002

emulator interface connection

The 'C80 supports emulation through a dedicated emulation port that is a superset of the IEEE Standard 1149.1 (JTAG) Standard. To support the 'C80 emulator, a target system must include a 14-pin header (2 rows of 7 pins) with the connections shown in Figure 124. Table 38 describes the emulation signal.

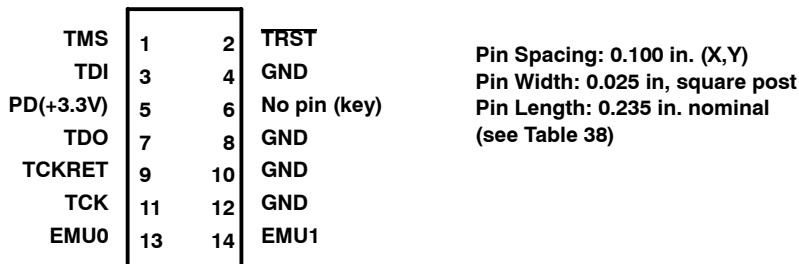

Figure 124. Target System Header

Table 38. Target Connectors

XDS510™ SIGNAL	XDS510 STATE	TARGET STATE	DESCRIPTION
TMS	O	I	Test-mode select†
TDI	O	I	Test-data input†
TDO	I	O	Test-data output†
TCK	O	I	Test clock - 10-MHz clock source from emulator. Can be used to drive system-test clock.†
TRST	O	I	Test reset†
EMU0	I	I/O	Emulation pin 0
EMU1	I	I/O	Emulation pin 1
PD (3.3 V)	I	O	Presence detect. Indicates that the target is connected and powered up. Should be tied to + 3.3 V on target system.
TCKRET	I	O	Test clock return. Test clock input to the XDS510 emulator. Can be buffered or unbuffered version of TCK.†

† IEEE Standard 1149.1

For best results, the emulation header should be located as close as possible to the 'C80. If the distance exceeds six inches, the emulation signals should be buffered. See Figure 125.

XDS510 is a trademark of Texas Instruments Incorporated.



emulator-interface connection (continued)

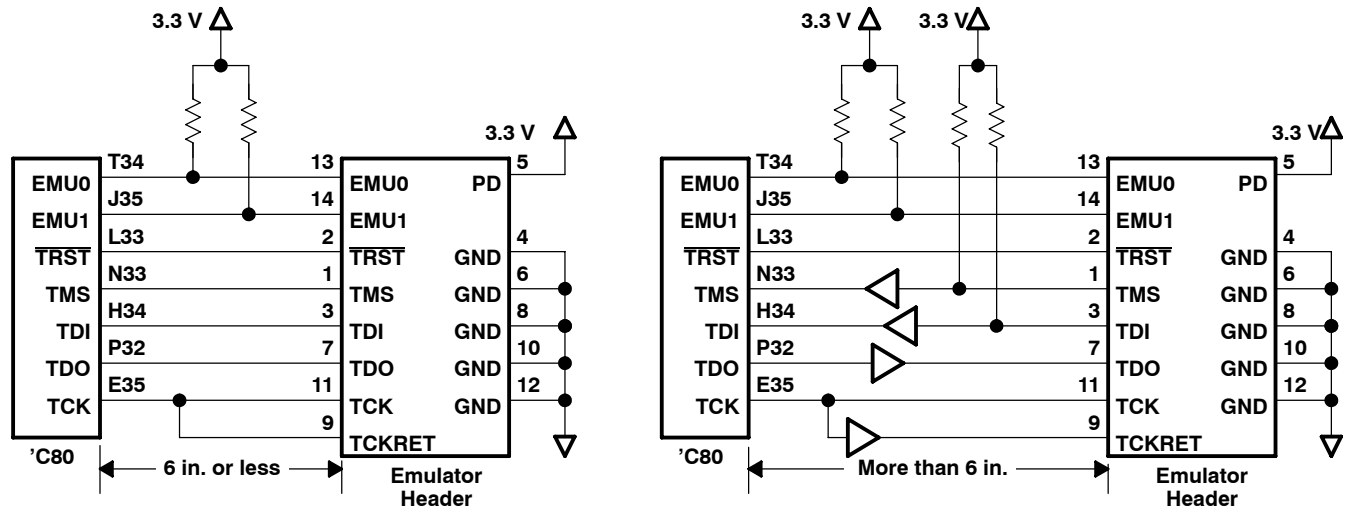

Figure 125. Emulation Header Connections - Emulator-Driven Test Clock

The target system also can generate the test clock. This allows the user to:

- Set the test clock frequency to match the system requirements. (The emulator provides only a 10-MHz test clock.)
- Have other devices in the system that require a test clock when the emulator is not connected

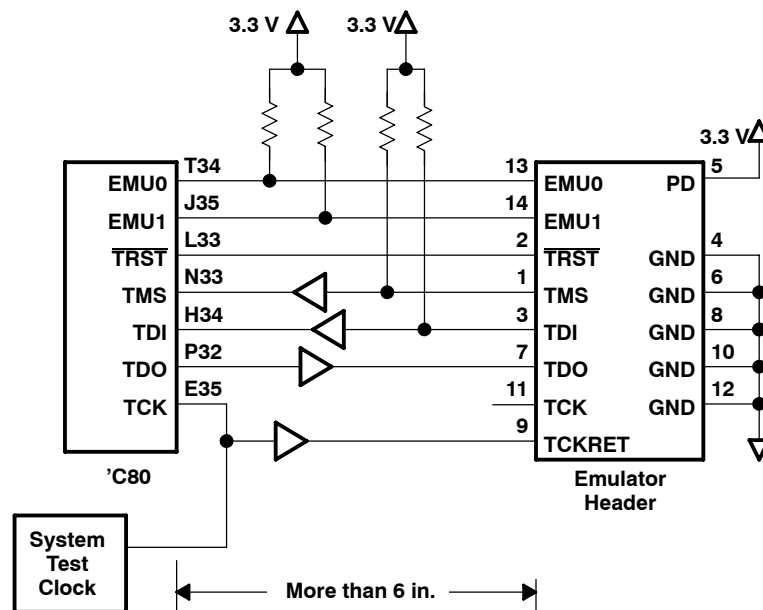

Figure 126. Emulation Header Connections - System-Driven Test Clock

emulator-interface connection (continued)

For multiprocessor applications, the following conditions are recommended:

- To reduce timing skew, buffer TMS, TDI, TDO, and TCK through the same physical package.
- If buffering is used, 4.7-kΩ resistors are recommended for TMS, TDI, and TCK, which should be pulled high (3.3 V).
- Buffering EMU0 and EMU1 is recommended highly to provide isolation. The buffers need not be in the same physical package as TMS, TCK, TDI, or TDO. Pullups to 3.3 V are required and should provide a signal rise time of less than 10 μs. A 4.7-kΩ resistor is suggested for most applications.
- To ensure high-quality signals, special printed wire board (PWB) routing and use of termination resistors may be required. The emulator provides fixed series termination (33 Ω) on TMS and TDI, and optional parallel terminators (180-Ω pullup and 270-Ω pulldown) on TCKRET and TDO.

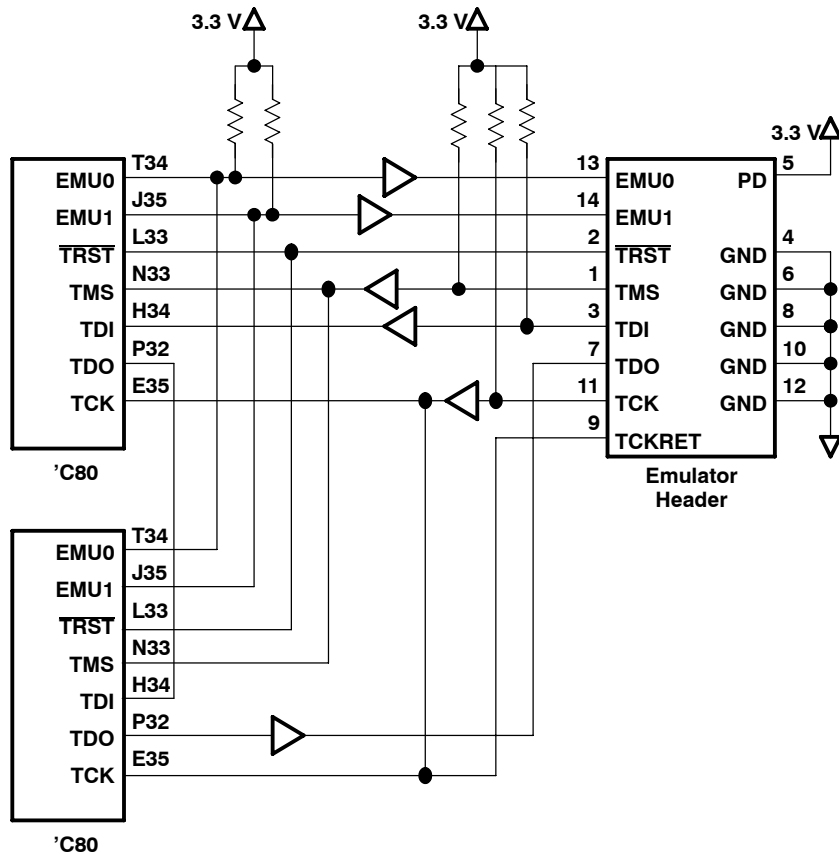
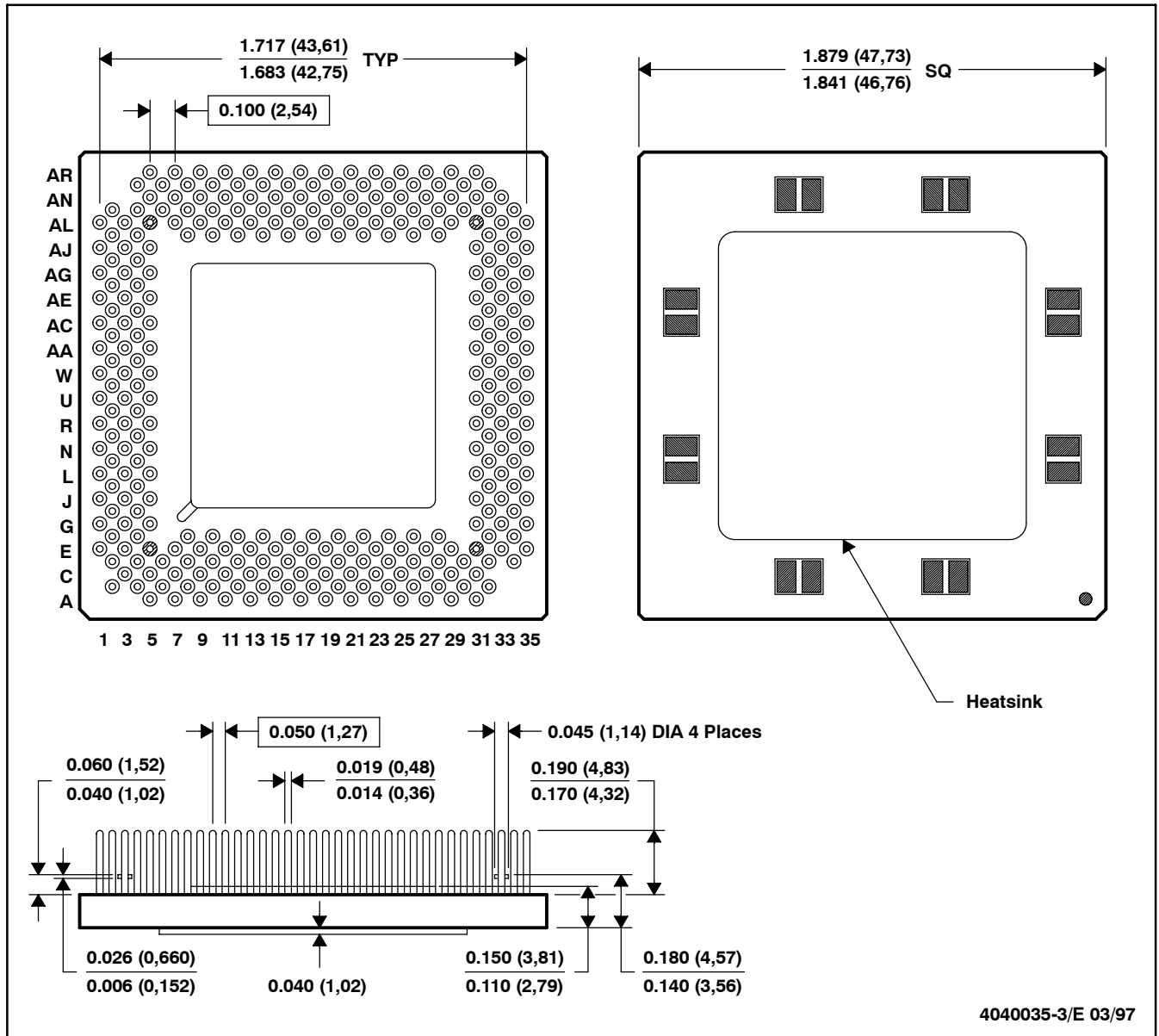

Figure 127. Emulation Header Connections - Multiprocessor Applications

MECHANICAL DATA

GF (S-CPGA-P305)

CERAMIC PIN GRID ARRAY PACKAGE



- NOTES: A. All linear dimensions are in inches (millimeters).
 B. This drawing is subject to change without notice.
 C. Package thickness of 0.150 (3,81) / 0.110 (2,79) includes package body and lid, but does not include integral heatsink or attached features.

SMJ320C80 DIGITAL SIGNAL PROCESSOR

SGUS025A - AUGUST 1998 - REVISED JUNE 2002

MECHANICAL DATA

HFH (R-CQFP-F320)

CERAMIC QUAD FLATPACK WITH NCTB

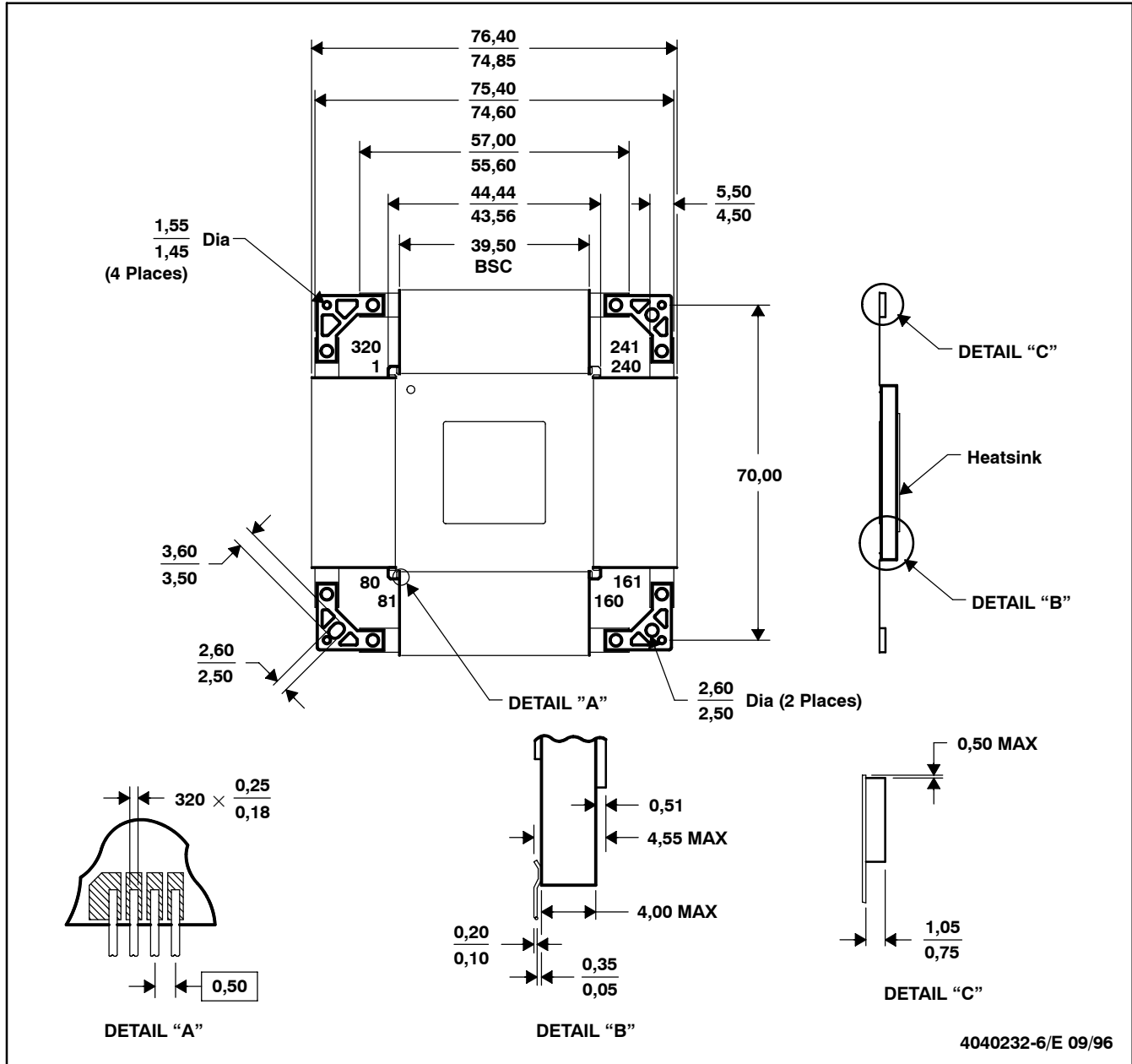

- NOTES: A. All linear dimensions are in millimeters.
 B. This drawing is subject to change without notice.
 C. This package can be hermetically sealed with a metal lid.
 D. The terminals will be gold plated.
 E. Falls within JEDEC MO-134 AD

PACKAGING INFORMATION

Orderable Device	Status (1)	Package Type	Package Drawing	Pins	Package Qty	Eco Plan (2)	Lead finish/ Ball material (6)	MSL Peak Temp (3)	Op Temp (°C)	Device Marking (4/5)	Samples
5962-9679101QXA	ACTIVE	CPGA	GF	305	1	Non-RoHS & Green	Call TI	N / A for Pkg Type	-55 to 125	5962-9679101QX A SMJ320C80GFM50	Samples
SM320C80GFM50	ACTIVE	CPGA	GF	305	1	RoHS-Exempt & Green	Call TI	N / A for Pkg Type	-55 to 125	SM320C80GFM50	Samples
SM320C80HFHM50	ACTIVE	CFP	HFH	320	1	RoHS & Green	Call TI	N / A for Pkg Type	-55 to 125	SM320C80HFHM50	Samples
SMJ320C80GFM50	ACTIVE	CPGA	GF	305	1	Non-RoHS & Green	Call TI	N / A for Pkg Type	-55 to 125	5962-9679101QX A SMJ320C80GFM50	Samples

(1) The marketing status values are defined as follows:

ACTIVE: Product device recommended for new designs.

LIFEBUY: TI has announced that the device will be discontinued, and a lifetime-buy period is in effect.

NRND: Not recommended for new designs. Device is in production to support existing customers, but TI does not recommend using this part in a new design.

PREVIEW: Device has been announced but is not in production. Samples may or may not be available.

OBSOLETE: TI has discontinued the production of the device.

(2) **RoHS:** TI defines "RoHS" to mean semiconductor products that are compliant with the current EU RoHS requirements for all 10 RoHS substances, including the requirement that RoHS substance do not exceed 0.1% by weight in homogeneous materials. Where designed to be soldered at high temperatures, "RoHS" products are suitable for use in specified lead-free processes. TI may reference these types of products as "Pb-Free".

RoHS Exempt: TI defines "RoHS Exempt" to mean products that contain lead but are compliant with EU RoHS pursuant to a specific EU RoHS exemption.

Green: TI defines "Green" to mean the content of Chlorine (Cl) and Bromine (Br) based flame retardants meet JS709B low halogen requirements of <=1000ppm threshold. Antimony trioxide based flame retardants must also meet the <=1000ppm threshold requirement.

(3) MSL, Peak Temp. - The Moisture Sensitivity Level rating according to the JEDEC industry standard classifications, and peak solder temperature.

(4) There may be additional marking, which relates to the logo, the lot trace code information, or the environmental category on the device.

(5) Multiple Device Markings will be inside parentheses. Only one Device Marking contained in parentheses and separated by a "~" will appear on a device. If a line is indented then it is a continuation of the previous line and the two combined represent the entire Device Marking for that device.

(6) Lead finish/Ball material - Orderable Devices may have multiple material finish options. Finish options are separated by a vertical ruled line. Lead finish/Ball material values may wrap to two lines if the finish value exceeds the maximum column width.

Important Information and Disclaimer:The information provided on this page represents TI's knowledge and belief as of the date that it is provided. TI bases its knowledge and belief on information provided by third parties, and makes no representation or warranty as to the accuracy of such information. Efforts are underway to better integrate information from third parties. TI has taken and continues to take reasonable steps to provide representative and accurate information but may not have conducted destructive testing or chemical analysis on incoming materials and chemicals. TI and TI suppliers consider certain information to be proprietary, and thus CAS numbers and other limited information may not be available for release.

In no event shall TI's liability arising out of such information exceed the total purchase price of the TI part(s) at issue in this document sold by TI to Customer on an annual basis.

OTHER QUALIFIED VERSIONS OF SM320C80 :

- Military : [SMJ320C80](#)

NOTE: Qualified Version Definitions:

- Military - QML certified for Military and Defense Applications

TRAY



Chamfer on Tray corner indicates Pin 1 orientation of packed units.

*All dimensions are nominal

Device	Package Name	Package Type	Pins	SPQ	Unit array matrix	Max temperature (°C)	L (mm)	W (mm)	K0 (µm)	P1 (mm)	CL (mm)	CW (mm)
5962-9679101QXA	GF	CPGA	305	1	2X5	45	314.98	135.89	12190	60.96	35.56	34.93
SM320C80GFM50	GF	CPGA	305	1	2X5	45	314.98	135.89	12190	60.96	35.56	34.93
SMJ320C80GFM50	GF	CPGA	305	1	2X5	45	314.98	135.89	12190	60.96	35.56	34.93

GF (S-CPGA-P305)

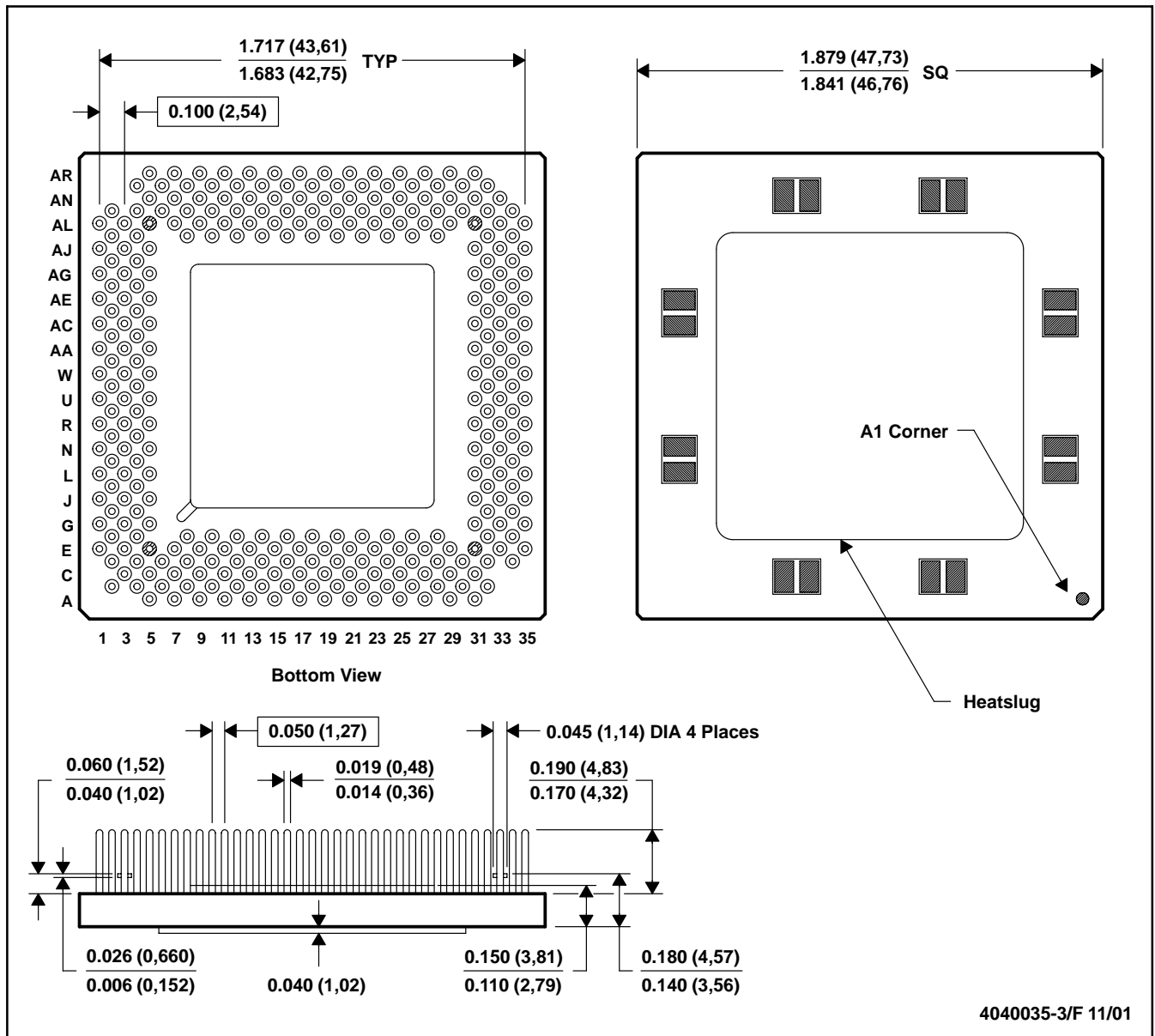
CERAMIC PIN GRID ARRAY



- NOTES:
- All linear dimensions are in inches (millimeters).
 - This drawing is subject to change without notice.
 - Index mark can appear on top or bottom, depending on package vendor.
 - Pins are located within 0.010 (0,25) diameter of true position relative to each other at maximum material condition and within 0.030 (0,76) diameter relative to the edge of the ceramic.
 - This package can be hermetically sealed with metal lids or with ceramic lids using glass frit.
 - The pins can be gold-plated or solder-dipped.
 - Package thickness of 0.150 (3,81) / 0.110 (2,79) includes package body and lid, but does not include integral heatslug or attached features.
 - Falls within JEDEC MO-128AK

HFH (R-CQFP-F320)

CERAMIC QUAD FLATPACK WITH NCTB

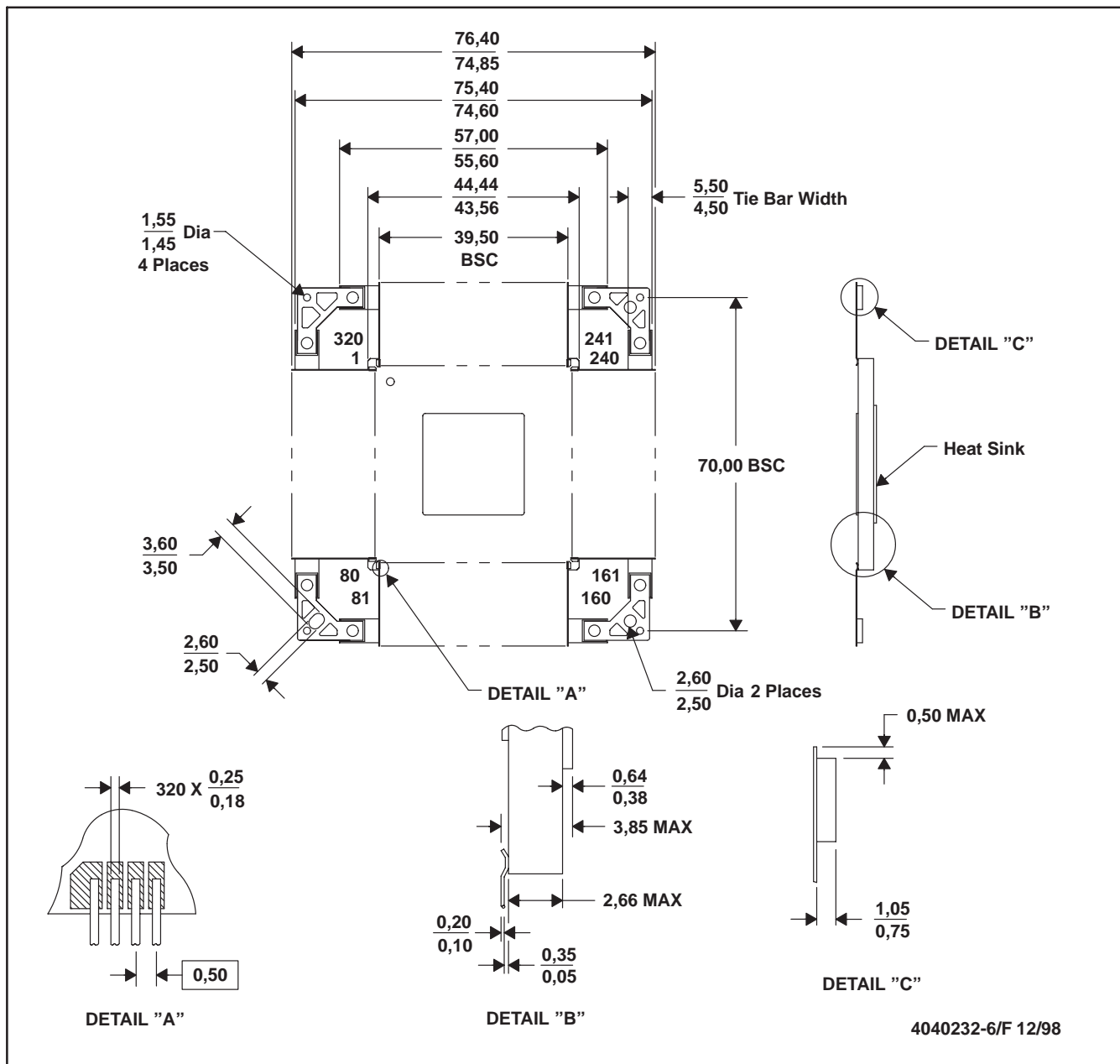

- NOTES:
- A. All linear dimensions are in millimeters.
 - B. This drawing is subject to change without notice.
 - C. This package is hermetically sealed with a metal lid.
 - D. The terminals are gold-plated.
 - E. Leads not shown for clarity purposes
 - F. Falls within JEDEC MO-134AD

4040232-6/F 12/98

HFH (R-CQFP-F320)

CERAMIC QUAD FLATPACK WITH NCTB

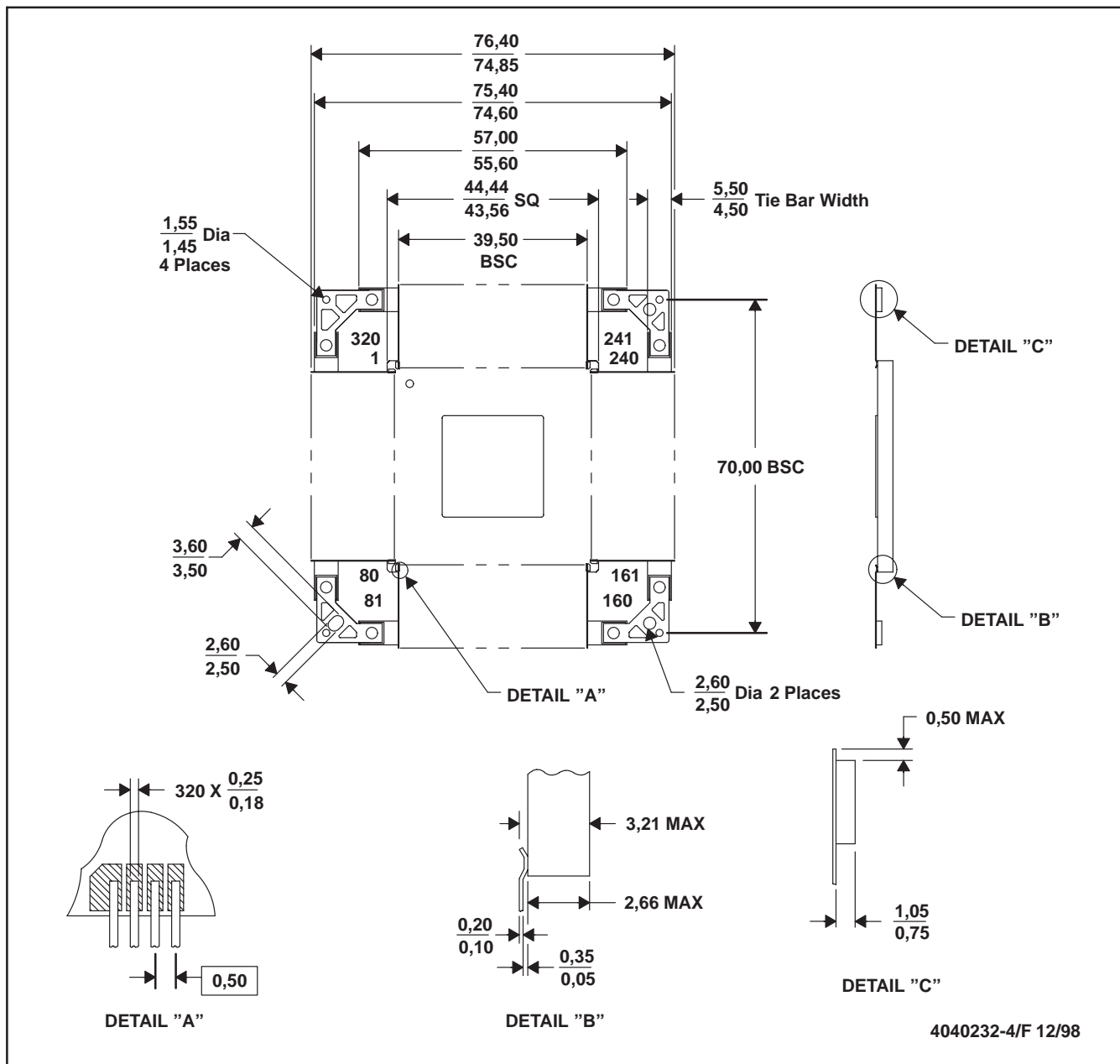

- NOTES: A. All linear dimensions are in millimeters.
 B. This drawing is subject to change without notice.
 C. This package is hermetically sealed with a metal lid.
 D. The terminals are gold-plated.
 E. Leads not shown for clarity purposes
 F. Falls within JEDEC MO-134AD

IMPORTANT NOTICE AND DISCLAIMER

TI PROVIDES TECHNICAL AND RELIABILITY DATA (INCLUDING DATA SHEETS), DESIGN RESOURCES (INCLUDING REFERENCE DESIGNS), APPLICATION OR OTHER DESIGN ADVICE, WEB TOOLS, SAFETY INFORMATION, AND OTHER RESOURCES "AS IS" AND WITH ALL FAULTS, AND DISCLAIMS ALL WARRANTIES, EXPRESS AND IMPLIED, INCLUDING WITHOUT LIMITATION ANY IMPLIED WARRANTIES OF MERCHANTABILITY, FITNESS FOR A PARTICULAR PURPOSE OR NON-INFRINGEMENT OF THIRD PARTY INTELLECTUAL PROPERTY RIGHTS.

These resources are intended for skilled developers designing with TI products. You are solely responsible for (1) selecting the appropriate TI products for your application, (2) designing, validating and testing your application, and (3) ensuring your application meets applicable standards, and any other safety, security, regulatory or other requirements.

These resources are subject to change without notice. TI grants you permission to use these resources only for development of an application that uses the TI products described in the resource. Other reproduction and display of these resources is prohibited. No license is granted to any other TI intellectual property right or to any third party intellectual property right. TI disclaims responsibility for, and you will fully indemnify TI and its representatives against, any claims, damages, costs, losses, and liabilities arising out of your use of these resources.

TI's products are provided subject to [TI's Terms of Sale](#) or other applicable terms available either on [ti.com](https://www.ti.com) or provided in conjunction with such TI products. TI's provision of these resources does not expand or otherwise alter TI's applicable warranties or warranty disclaimers for TI products.

TI objects to and rejects any additional or different terms you may have proposed.

Mailing Address: Texas Instruments, Post Office Box 655303, Dallas, Texas 75265
Copyright © 2023, Texas Instruments Incorporated