

# Surface-Mount PAR<sup>®</sup> Transient Voltage Suppressors

High Temperature Stability and High Reliability Conditions

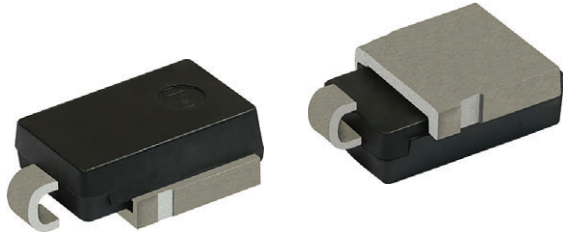

DO-218AB

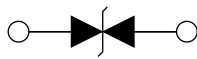

## LINKS TO ADDITIONAL RESOURCES



PRIMARY CHARACTERISTICS	
$V_{BR}$	11.1 V to 104 V
$V_{WM}$	10 V to 85 V
$P_{PPM}$ (10 x 1000 $\mu$ s)	6600 W
$P_{PPM}$ (10 x 10 000 $\mu$ s)	5000 W for 10CA to 20CA
	5200 W for 22CA to 85CA
$T_J$ max.	175 °C
Polarity	Bidirectional
Package	DO-218AB

## FEATURES

- RoHS compliant junction passivation
- $T_J = 175$  °C capability suitable for high reliability and automotive requirement
- Bidirectional
- Low leakage current
- High surge capability
- Meet ISO 7637-2 and ISO 16750-2 surge specification (varied by test condition)
- Meets MSL level 1, per J-STD-020, LF maximum peak of 245 °C
- AEC-Q101 qualified
- Material categorization: for definitions of compliance please see [www.vishay.com/doc?99912](http://www.vishay.com/doc?99912)



**RoHS**  
COMPLIANT  
HALOGEN  
**FREE**

## TYPICAL APPLICATIONS

Use in sensitive electronics protection against voltage transients induced by inductive load switching and lightning, especially for automotive load dump protection application.

## MECHANICAL DATA

**Case:** DO-218AB

Molding compound meets UL 94 V-0 flammability rating

Base P/NHM3 - halogen-free, RoHS-compliant, and AEC-Q101 qualified

**Terminals:** matte tin plated leads, solderable per J-STD-002 and JESD 22-B102

HM3 suffix meets JESD 201 class 2 whisker test

**Polarity:** bidirectional, no cathode band

MAXIMUM RATINGS ( $T_C = 25$ °C unless otherwise noted)					
PARAMETER		SYMBOL	VALUE	UNIT	
Peak pulse power dissipation	with 10/1000 $\mu$ s waveform (fig. 4)	$P_{PPM}^{(1)(2)}$	6600		W
	with 10/10 000 $\mu$ s waveform (fig. 5)		10CA to 20CA	5000	
			22CA to 85CA	5200	
Power dissipation on infinite heatsink at $T_C = 25$ °C (fig.2)		$P_D$	8.0		W
Peak pulse current with 10/1000 $\mu$ s waveform (fig. 4)		$I_{PPM}^{(1)}$	See next table		A
Operating junction and storage temperature range		$T_J, T_{STG}$	-55 to +175		°C

### Notes

(1) Non-repetitive current pulse derated above  $T_A = 25$  °C, per fig. 3

(2) Power calculation is based on  $I_{PPM}$  times defined maximum clamping voltage by pulse width



<b>ELECTRICAL CHARACTERISTICS</b> ( $T_C = 25\text{ }^\circ\text{C}$ unless otherwise noted)									
DEVICE TYPE	BREAKDOWN VOLTAGE $V_{BR}$ (V)			TEST CURRENT $I_T$ (mA)	STAND-OFF VOLTAGE $V_{WM}$ (V)	MAXIMUM REVERSE LEAKAGE AT $V_{WM}$ $I_D$ ( $\mu\text{A}$ )	MAXIMUM REVERSE LEAKAGE AT $V_{WM}$ $T_J = 175\text{ }^\circ\text{C}$ $I_D$ ( $\mu\text{A}$ )	MAX. PEAK PULSE CURRENT AT 10/1000 $\mu\text{s}$ WAVEFORM $I_{PPM}$ (A)	MAXIMUM CLAMPING VOLTAGE AT $I_{PPM}$ $V_C$ (V)
	MIN.	NOM.	MAX.						
SM8S10CA	11.1	11.7	12.3	5.0	10.0	15	250	388	17.0
SM8S11CA	12.2	12.9	13.5	5.0	11.0	10	150	363	18.2
SM8S12CA	13.3	14.0	14.7	5.0	12.0	10	150	332	19.9
SM8S13CA	14.4	15.2	15.9	5.0	13.0	10	150	307	21.5
SM8S14CA	15.6	16.4	17.2	5.0	14.0	10	150	284	23.2
SM8S15CA	16.7	17.6	18.5	5.0	15.0	10	150	270	24.4
SM8S16CA	17.8	18.8	19.7	5.0	16.0	10	150	254	26.0
SM8S17CA	18.9	19.9	20.9	5.0	17.0	10	150	239	27.6
SM8S18CA	20.0	21.1	22.1	5.0	18.0	10	150	226	29.2
SM8S20CA	22.2	23.4	24.5	5.0	20.0	10	150	204	32.4
SM8S22CA	24.4	25.7	26.9	5.0	22.0	10	150	186	35.5
SM8S24CA	26.7	28.1	29.5	5.0	24.0	10	150	170	38.9
SM8S26CA	28.9	30.4	31.9	5.0	26.0	10	150	157	42.1
SM8S28CA	31.1	32.8	34.4	5.0	28.0	10	150	145	45.4
SM8S30CA	33.3	35.1	36.8	5.0	30.0	10	150	136	48.4
SM8S33CA	36.7	38.7	40.6	5.0	33.0	10	150	124	53.3
SM8S36CA	40.0	42.1	44.2	5.0	36.0	10	150	114	58.1
SM8S40CA	44.4	46.8	49.1	5.0	40.0	10	150	102	64.5
SM8S43CA	47.8	50.3	52.8	5.0	43.0	10	150	95.1	69.4
SM8S45CA	50.0	52.7	55.3	5.0	45.0	10	150	90.8	72.7
SM8S48CA	53.3	56.1	58.9	5.0	48.0	10	150	85.3	77.4
SM8S51CA	56.7	59.7	62.7	5.0	51.0	10	150	80.1	82.4
SM8S54CA	60.0	63.2	66.3	5.0	54.0	10	150	75.8	87.1
SM8S58CA	64.4	67.8	71.2	5.0	58.0	10	150	70.5	93.6
SM8S60CA	66.7	70.2	73.7	5.0	60.0	10	150	68.2	96.8
SM8S64CA	71.1	74.9	78.6	5.0	64.0	10	150	64.1	103
SM8S70CA	77.8	81.9	86.0	5.0	70.0	10	150	58.4	113
SM8S75CA	83.3	87.7	92.1	5.0	75.0	10	150	54.5	121
SM8S78CA	86.7	91.3	95.8	5.0	78.0	10	150	52.4	126
SM8S85CA	94.4	99.2	104	5.0	85.0	10	150	48.2	137

<b>THERMAL CHARACTERISTICS</b> ( $T_A = 25\text{ }^\circ\text{C}$ unless otherwise noted)			
PARAMETER	SYMBOL	TYP.	UNIT
Thermal resistance	$R_{\theta JA}$ <sup>(1)</sup>	55	$^\circ\text{C/W}$
	$R_{\theta JM}$ <sup>(2)</sup>	0.35	$^\circ\text{C/W}$

**Note**

- (1) Thermal resistance junction-to-ambient to follow JEDEC<sup>®</sup> 51-2A, device mounted on FR4 PCB, 2 oz. standard footprint  
(2) Thermal resistance junction-to-mount to follow JEDEC<sup>®</sup> 51-14 using Transient Dual Interface Test Method (TDIM)

<b>ORDERING INFORMATION</b> (Example)				
PREFERRED P/N	UNIT WEIGHT (g)	PREFERRED PACKAGE CODE	BASE QUANTITY	DELIVERY MODE
SM8S10CAHM3/I <sup>(1)</sup>	2.605	I	750	13" diameter plastic tape and reel, anode towards the sprocket hole

**Note**

- (1) AEC-Q101 qualified



**RATINGS AND CHARACTERISTICS CURVES** ( $T_A = 25\text{ }^\circ\text{C}$  unless otherwise noted)

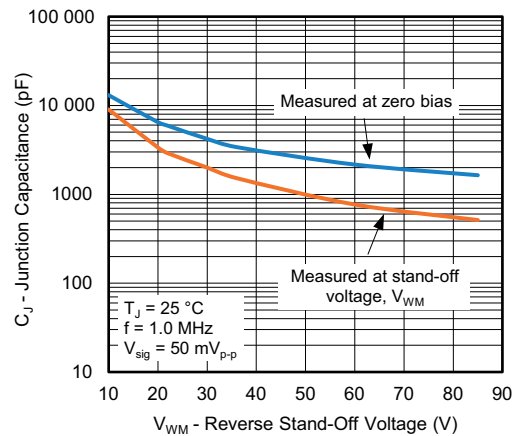
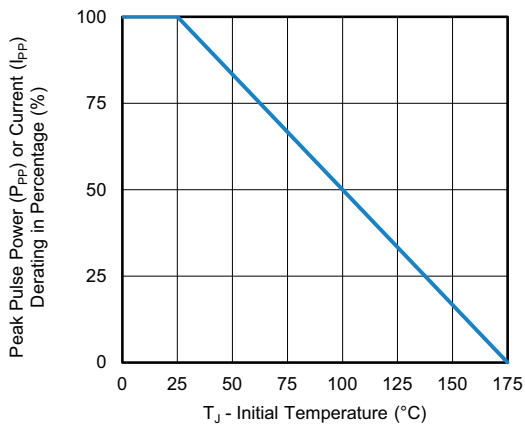
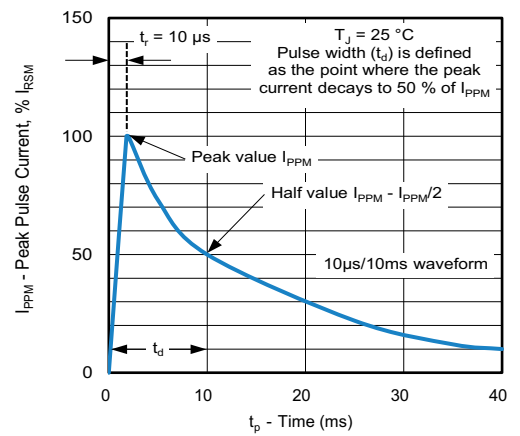
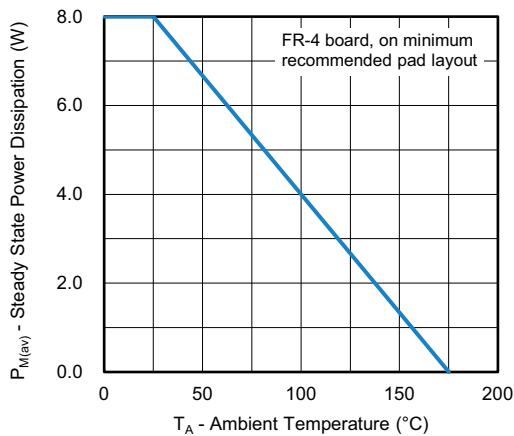
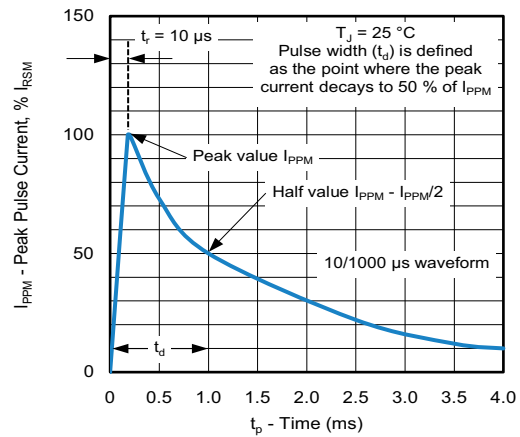
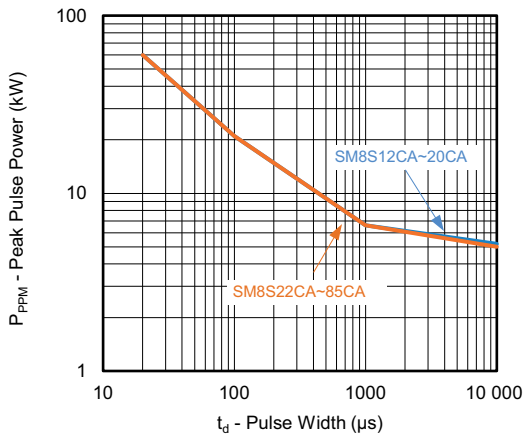

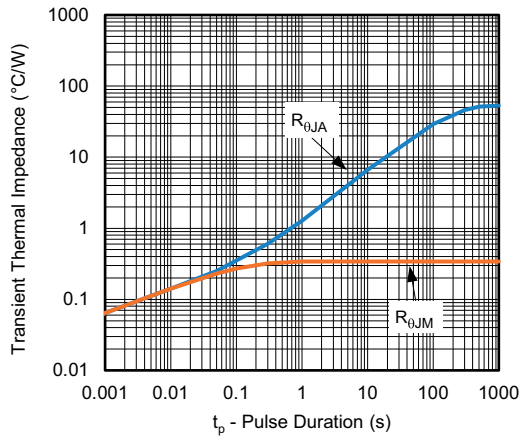
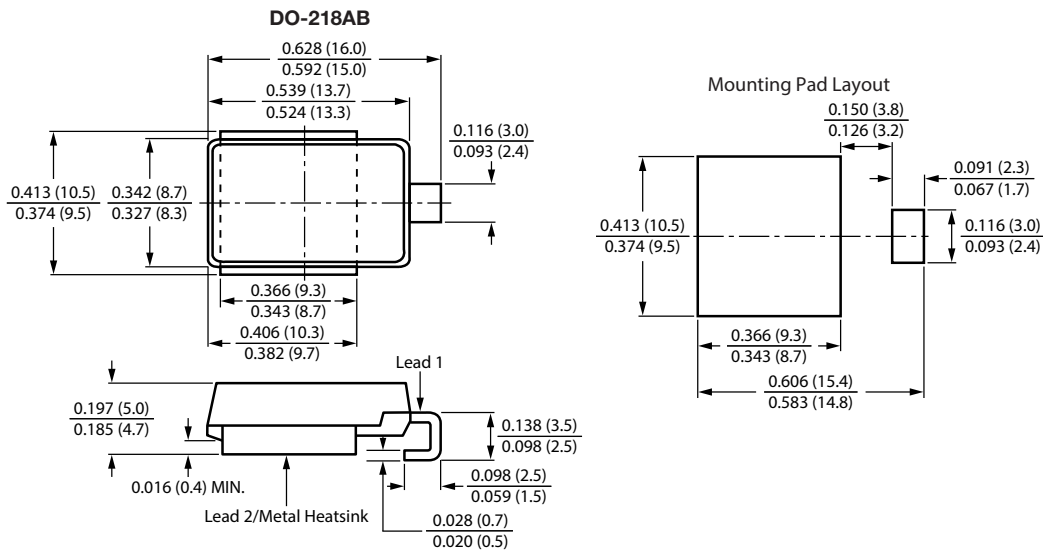

Fig. 7 - Typical Transient Thermal Impedance

**Note**

- Fig.1 - Power calculation is based on  $I_{PPM}$  times defined maximum clamping voltage by pulse width

**PACKAGE OUTLINE DIMENSIONS** in inches (millimeters)





## Disclaimer

ALL PRODUCT, PRODUCT SPECIFICATIONS AND DATA ARE SUBJECT TO CHANGE WITHOUT NOTICE TO IMPROVE RELIABILITY, FUNCTION OR DESIGN OR OTHERWISE.

Vishay Intertechnology, Inc., its affiliates, agents, and employees, and all persons acting on its or their behalf (collectively, "Vishay"), disclaim any and all liability for any errors, inaccuracies or incompleteness contained in any datasheet or in any other disclosure relating to any product.

Vishay makes no warranty, representation or guarantee regarding the suitability of the products for any particular purpose or the continuing production of any product. To the maximum extent permitted by applicable law, Vishay disclaims (i) any and all liability arising out of the application or use of any product, (ii) any and all liability, including without limitation special, consequential or incidental damages, and (iii) any and all implied warranties, including warranties of fitness for particular purpose, non-infringement and merchantability.

Statements regarding the suitability of products for certain types of applications are based on Vishay's knowledge of typical requirements that are often placed on Vishay products in generic applications. Such statements are not binding statements about the suitability of products for a particular application. It is the customer's responsibility to validate that a particular product with the properties described in the product specification is suitable for use in a particular application. Parameters provided in datasheets and / or specifications may vary in different applications and performance may vary over time. All operating parameters, including typical parameters, must be validated for each customer application by the customer's technical experts. Product specifications do not expand or otherwise modify Vishay's terms and conditions of purchase, including but not limited to the warranty expressed therein.

Hyperlinks included in this datasheet may direct users to third-party websites. These links are provided as a convenience and for informational purposes only. Inclusion of these hyperlinks does not constitute an endorsement or an approval by Vishay of any of the products, services or opinions of the corporation, organization or individual associated with the third-party website. Vishay disclaims any and all liability and bears no responsibility for the accuracy, legality or content of the third-party website or for that of subsequent links.

Except as expressly indicated in writing, Vishay products are not designed for use in medical, life-saving, or life-sustaining applications or for any other application in which the failure of the Vishay product could result in personal injury or death. Customers using or selling Vishay products not expressly indicated for use in such applications do so at their own risk. Please contact authorized Vishay personnel to obtain written terms and conditions regarding products designed for such applications.

No license, express or implied, by estoppel or otherwise, to any intellectual property rights is granted by this document or by any conduct of Vishay. Product names and markings noted herein may be trademarks of their respective owners.