

TPS7A4501SPEVM User's Guide

This user's guide describes the characteristics, operation, and use of the TPS7A4501SP evaluation module (EVM). This user's guide includes setup instructions, a schematic diagram, a bill of materials (BOM), and printed-circuit board (PCB) layout drawings for the EVM.

Contents

1	Introduction	2
2	Background	2
3	Safety	2
4	Equipment	3
5	Board Layout	4
6	Bench Test Setup Conditions	9
7	Power-Up Procedure	10
8	I_{OUT} and V_{OUT} Measurements	10
9	Optional Board Modifications	14
10	Schematic and Bill of Materials	15

List of Figures

1	Component Placement (Top Side)	4
2	PCB Layout (Top Layer)	5
3	Board Layout - Second Layer (Mid Layer 1) Ground Plane	6
4	Board Layout - Third Layer (Mid Layer 2) Power Plane	7
5	Board Layout - Fourth Layer (Bottom Layer)	8
6	Headers Description and Jumper Placement	9
7	V_{DO} vs I_{OUT}	10
8	V_{OUT} Undershoot When the Load is Stepped To and From 10 mA and 1.5 A	11
9	V_{OUT} Overshoot When the Load is Stepped To and From 10 mA and 1.5 A	11
10	V_{OUT} Undershoot When the Load is Stepped To and From 500 mA and 1.1 A	11
11	V_{OUT} Undershoot When the Load is Stepped To and From 10 mA and 1.5 A	11
12	V_{OUT} and V_{IN} With no Soft-Start	12
13	V_{OUT} and V_{IN} With Soft-Start Circuit	12
14	Best-Case RMS Noise (10 Hz - 100 kHz) = 16.86 μ Vrms, V_{IN} = 5.5 V, V_{OUT} = 5 V at no Load	13
15	Worst-Case RMS Noise (10 Hz - 100 kHz) = 47.39 μ Vrms, V_{IN} = 5.5 V, V_{OUT} = 5 V at 1.5 A Load	13
16	Schematic of the Feedback Network	14
17	TPS7A4501SPEVM Schematic	15

List of Tables

1	Summary of Performance	2
2	Connector and Header Information	9
3	Test Results	10
4	Soft-Start Circuit Scenarios	12
5	TPS7H1101SPEVM Bill of Materials	16

All trademarks are the property of their respective owners.

1 Introduction

This EVM demonstrates the Texas Instruments TPS7A4501SP ultra low-dropout (LDO) regulator. It is rated as an 1.5-A ultra LDO voltage regulator.

1.1 Related Documentation

- TPS7A4501SP datasheet ([SLVSC31A](#))

2 Background

The TPS7A4501SPEVM helps designers evaluate the operation and performance of the TPS7A4501SP ultra LDO regulator.

Table 1. Summary of Performance

Test Conditions	Output Current Range
$V_{IN} = 2.3 \text{ V to } 20 \text{ V}$	Max 1.5 A

The evaluation module is designed to provide access to the features of the TPS7A4501. Some modifications can be made to this module to test performance at different input and output voltages, current, and soft-start features. Please contact TI Field Applications Group for advice on these matters.

3 Safety

3.1 Eye Protection

Wear safety glasses while performing any tests on the EVM.

3.2 General Risks

This test must be performed by qualified personnel trained in electronics theory who understand the risks and hazards of the assembly under test.

3.3 Electrostatic Discharge

ESD precautions must be followed while handling electronic assemblies.

3.4 Thermal/Shock Hazards

Precautions should be observed to avoid touching areas of the assembly that may get hot or present a shock hazard during testing.

3.5 Apparel

Use the following apparel any time the EVM is used:

- Electrostatic smock
- Electrostatic gloves or finger cots
- Safety glasses
- Ground ESD wrist strap

4 Equipment

4.1 Power Supplies

Power Supply #1 (PS#1): a power supply capable of supplying 7-V at 2-A or higher, as required.

4.2 Load #1

Electronic load, that is, Chroma 63640-80-80 module along with 63600-2 DC electronic load Mainframe or a Decade Resistor Box.

4.3 Meters

Four (4) Fluke 75, (equivalent or better) or two (3) equivalent voltage meters and two (2) equivalent current meters.

The current meters must be able to measure 2-A current. **Note:** A shunt along with DVM can be used to monitor output current.

4.4 Oscilloscope

An Tektronix oscilloscope with both voltage and current probes, that is, DPO 7104C, Tektronix TCP202, or equivalent.

5 Board Layout

Figure 1 through Figure 5 illustrate the PCB layouts.

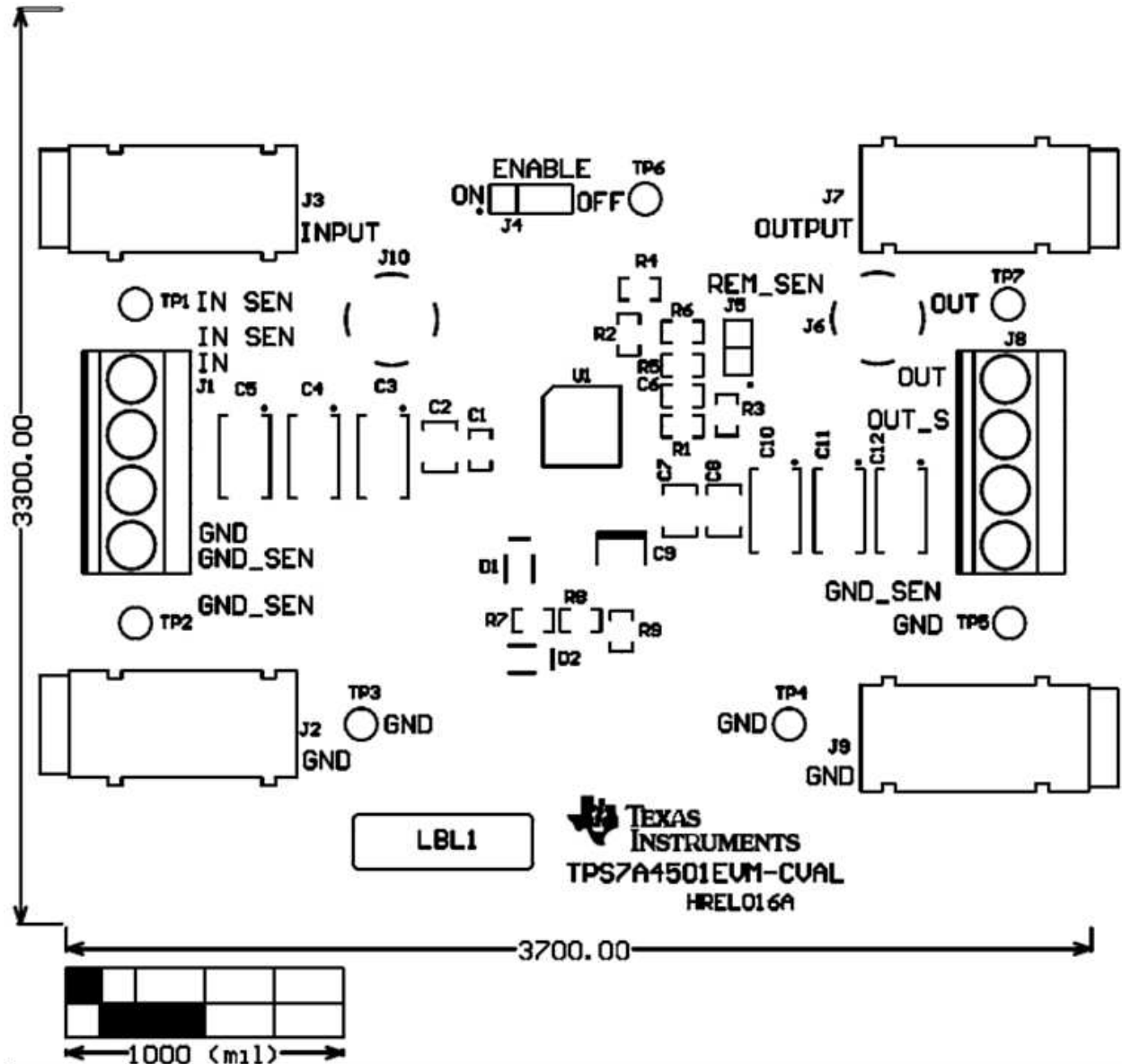

Figure 1. Component Placement (Top Side)

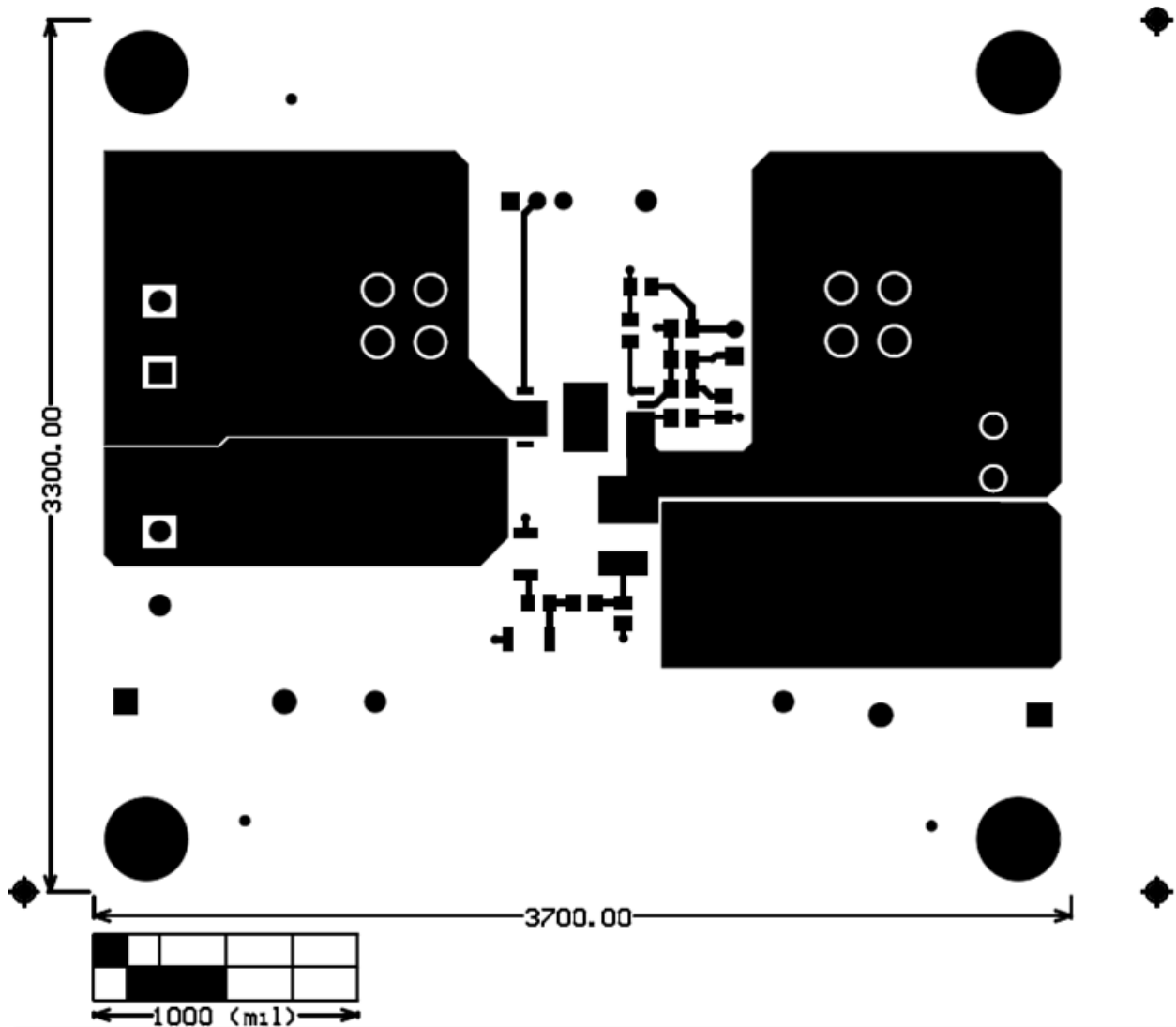

Figure 2. PCB Layout (Top Layer)

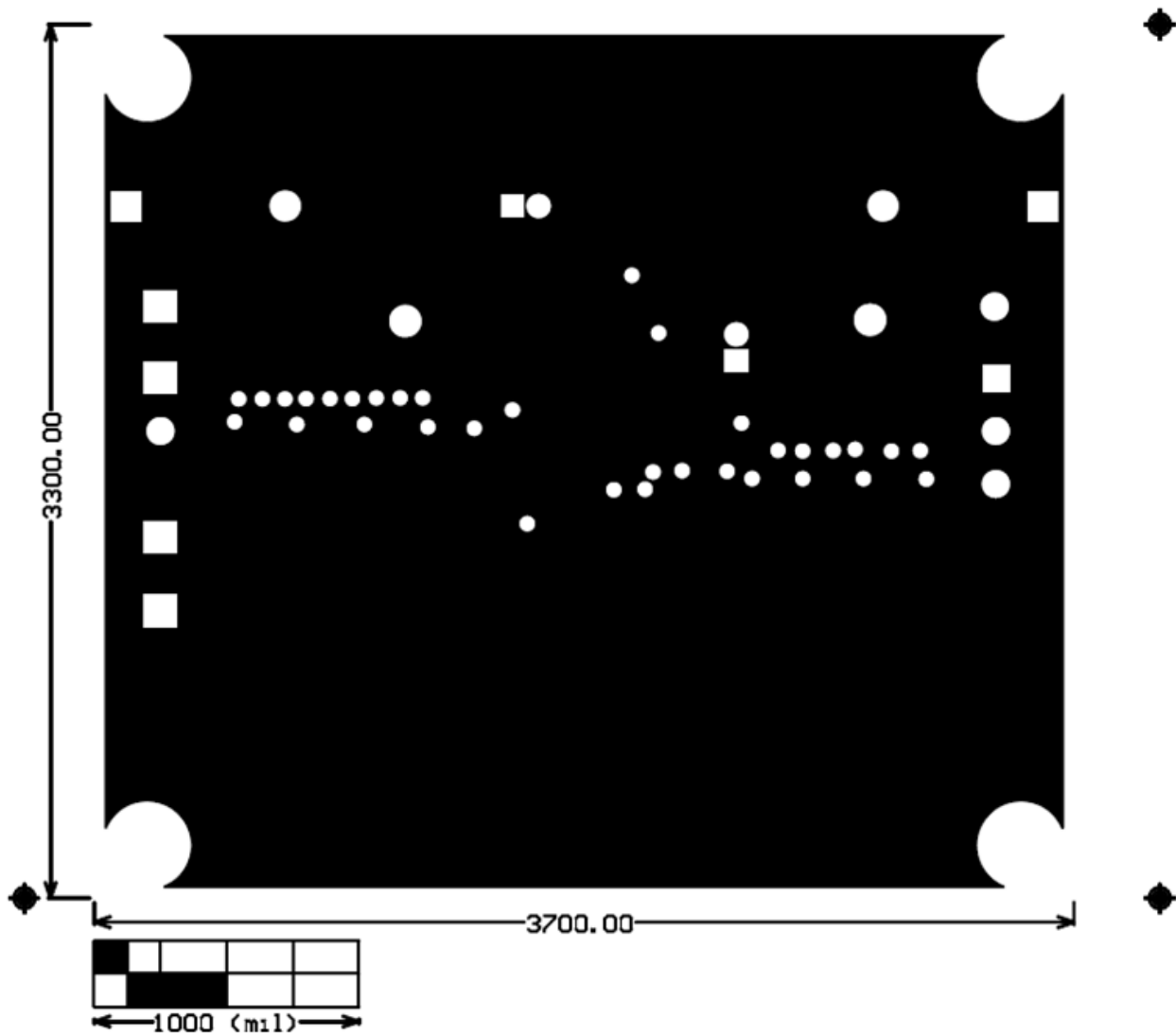

Figure 3. Board Layout - Second Layer (Mid Layer 1) Ground Plane

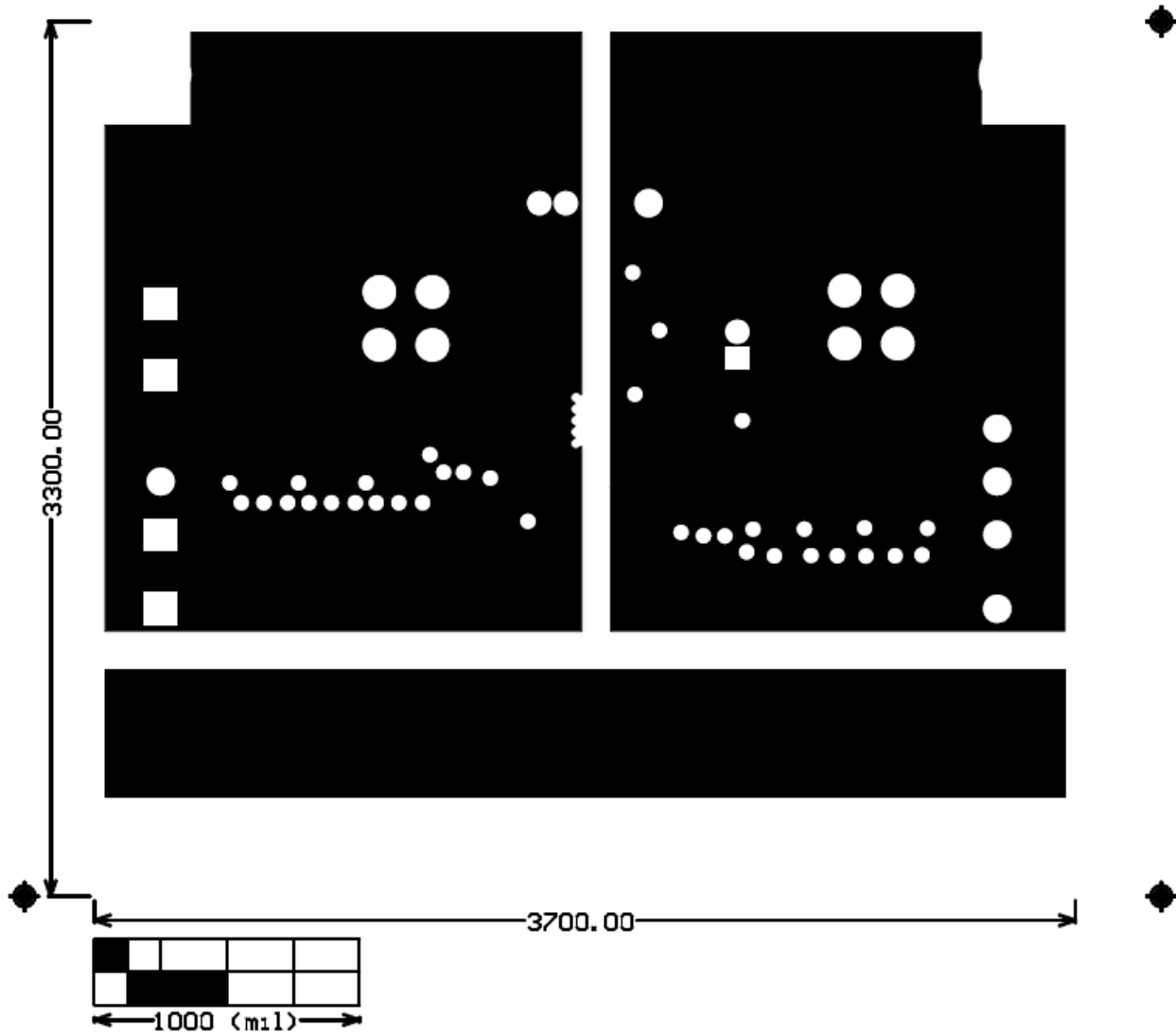

Figure 4. Board Layout - Third Layer (Mid Layer 2) Power Plane

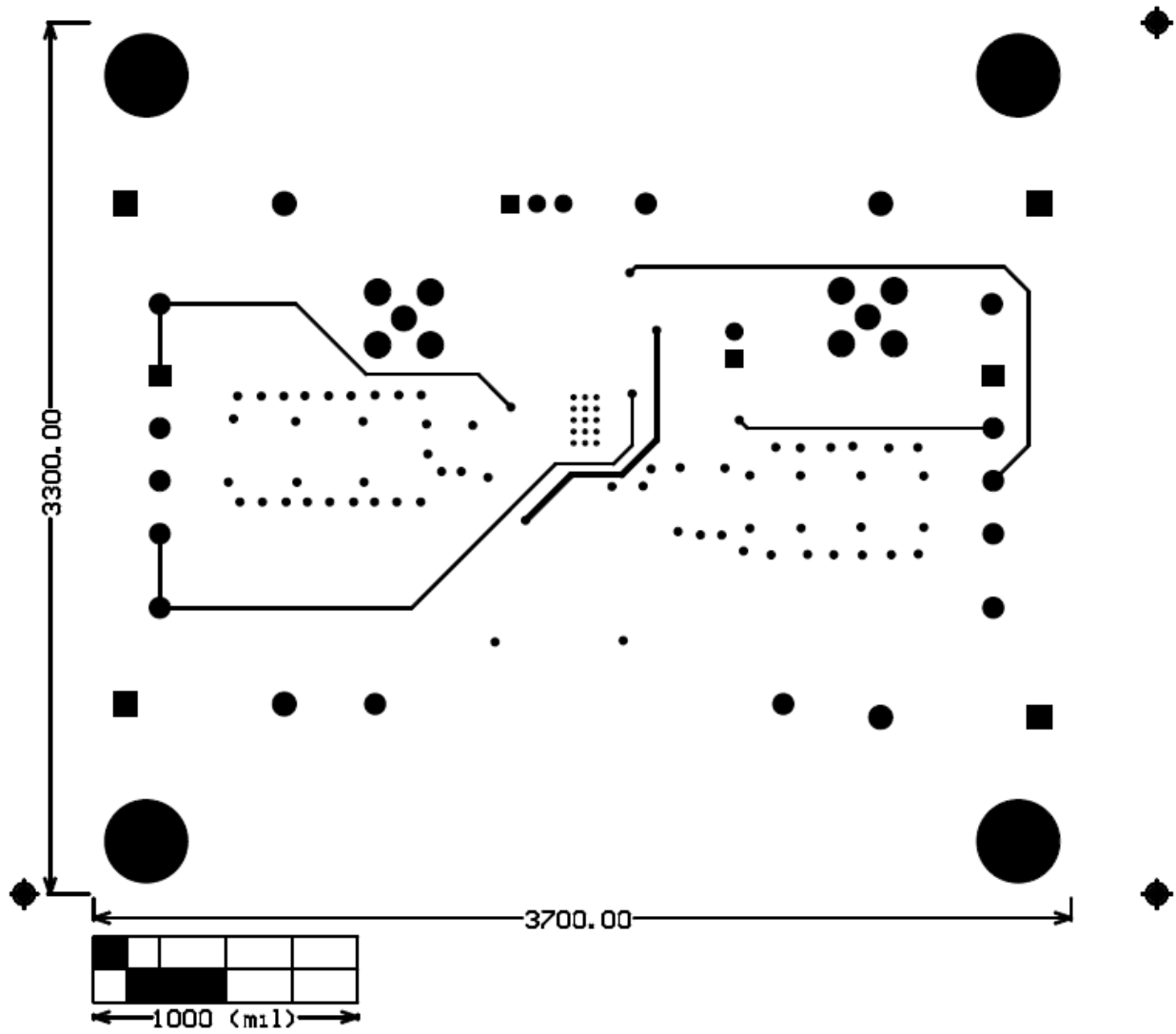

Figure 5. Board Layout - Fourth Layer (Bottom Layer)

6 Bench Test Setup Conditions

6.1 Header Descriptions and Jumper Placement

Figure 6 illustrates the header descriptions and jumper placement.

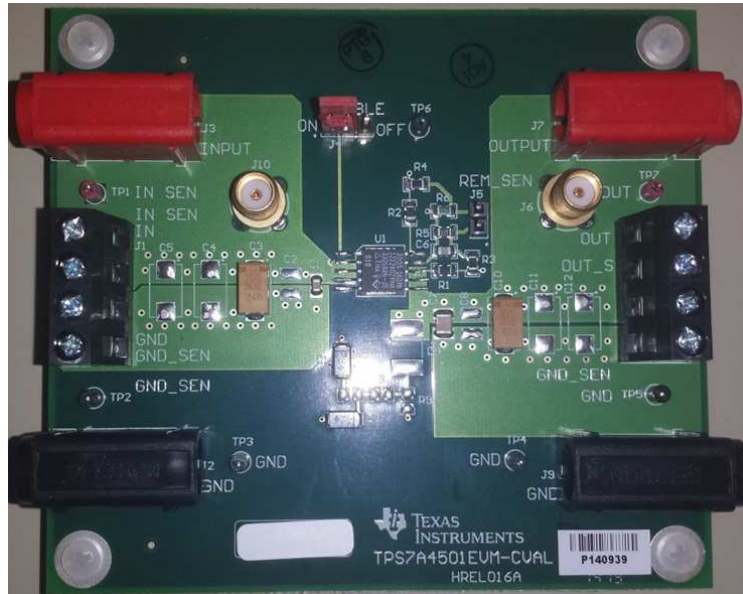

Figure 6. Headers Description and Jumper Placement

6.2 Testing

Table 2 lists the connector and header information.

Table 2. Connector and Header Information

Reference Designator	Functions
J1	Input voltage and ground terminal block. Pins 1 & 4 are for sensing purposes only.
J2	Ground (GND).
J3	Input voltage banana connector. Electrically connected to pins 1 & 2 of J1.
J4	Enable/disable the regulator.
J5	External remote sense
J6	Output voltage SMA connection. Caution: this node is DC-coupled and may damage some equipment if AC-coupling is not provided externally.
J7	Output voltage banana connector. Electrically connected to J6.
J8	Output voltage and ground terminal block. Pins 2 & 3 are for sensing purposes only.
J9	Ground (GND)
J10	Input voltage SMA connection. Caution: this node is DC-coupled and may damage some equipment if AC-coupling is not provided externally.
TP1	Test point for the input voltage node. Electrically connected to J10, J3, and J1 (pins 1 & 2).
TP2	Ground (GND)
TP3	Ground (GND)
TP4	Ground (GND)
TP5	Ground (GND)
TP6	Ground (GND)
TP7	Test point for the output voltage node. Electrically connected to J10, J7, and J8 (pins 1 & 2).

7 Power-Up Procedure

Table 3 displays the test results.

Table 3. Test Results

	V_{OUTMIN}	V_{OUTMAX}	Current Limit
$V_{OUT} = 5\text{ V}$	4.8 V	5.1 V	$1.5\text{ A} < I_{LIMIT} < 2.0\text{ A}$

8 I_{OUT} and V_{OUT} Measurements

1. Make sure all power supplies on the bench are OFF
2. Locate header J4. Place a jumper in the "ON" position.
3. Locate banana sockets J2 and J3. Plug GND into J2 and VIN from the power supply to J3.
4. Alternatively, appropriately-sized wires can be inserted into J1 pins 3 and 2 (respectively).
5. Connect the load + to J7 and load – to J9. An ammeter may be placed in series as required.
6. Set the power supply to 5.5 V.
7. The output should measure between 4.8 V to 5.1 V for loads 1.5 A and under with no significant ripple/oscillation.
8. The internal current limiter should take effect between 1.5-A to 2-A loads. In this case, the output would be outside of the specified regulation range. Above 2 A, the output should be zero volts.

8.1 Dropout Voltage

Drop out voltage (V_{DO}) is the difference between the input voltage and output voltage needed to maintain regulation. The following VDO test was done with the EVM in default configuration ($V_{OUT} = 5\text{ V}$). V_{DO} vs I_{OUT} is highlighted in Figure 7.

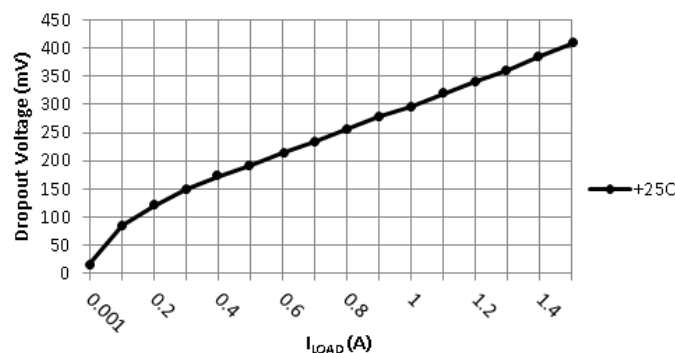

Figure 7. V_{DO} vs I_{OUT}

The dropout voltage is defined as the minimum voltage differential between the input and the output required for the series-pass transistor to be in saturation, and therefore, for the output to be within the line regulation specification. The dropout voltage is the result of the effective on-resistance of the series pass transistor. At room temperature, the on-resistance of the pass transistor is interpreted to be about $0.23\ \Omega$ when the input voltage is at the lowest possible to maintain regulation at a specified output voltage. Because the effective on-resistance of the series-pass transistor has a positive temperature coefficient, the effective on-resistance is higher; therefore, the dropout voltage is higher at higher operating temperatures and lower for lower operating temperatures.

8.2 Transient Response

The waveforms in Figure 8 to Figure 10 show the line regulation of the LDO under two scenarios of load changes.

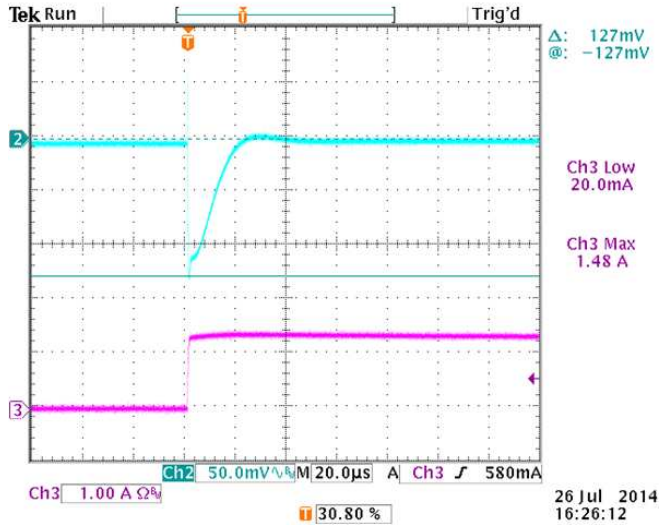

Figure 8. V_{OUT} Undershoot When the Load is Stepped To and From 10 mA and 1.5 A

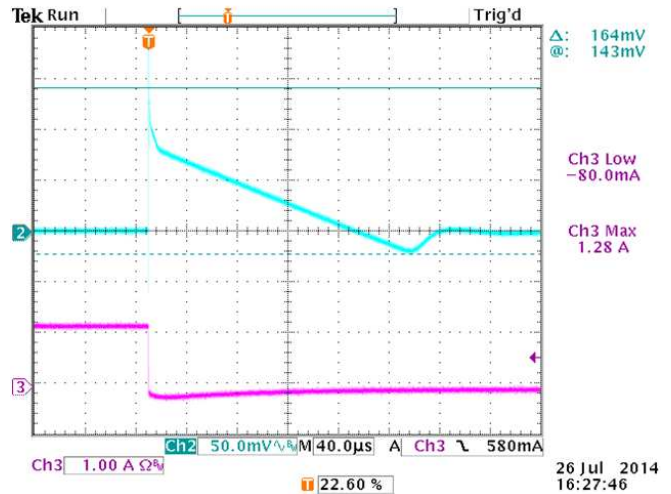

Figure 9. V_{OUT} Overshoot When the Load is Stepped To and From 10 mA and 1.5 A

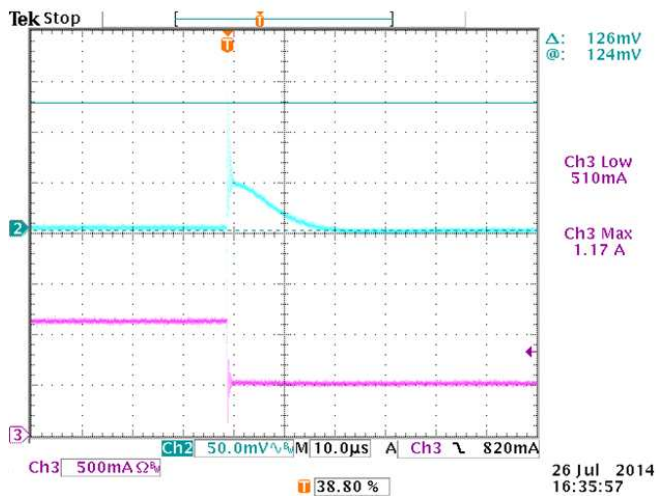

Figure 10. V_{OUT} Undershoot When the Load is Stepped To and From 500 mA and 1.1 A

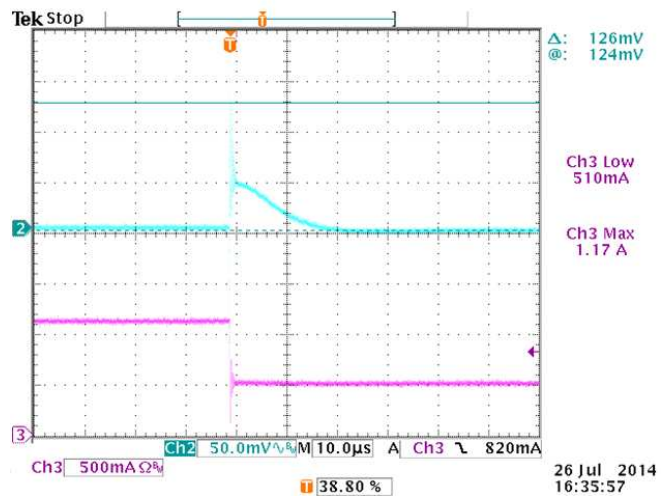

Figure 11. V_{OUT} Undershoot When the Load is Stepped To and From 10 mA and 1.5 A

The cyan oscilloscope trace is V_{OUT} and the pink is the I_{OUT} current using the Tektronix TCP202 current clamp.

The transient test was performed by using two fixed resistors in parallel and a MOSFET to enable/disable one of the two resistors. The text fixture was placed directly at the output screw terminals without using long banana-jack cables to minimize series inductance.

8.3 Soft-Start

See Section 9.3 to implement the soft-start feature onto the EVM.

V_{OUT} soft-start is achieved by the use of two diodes, two resistors, and a capacitor placed within the feedback loop. The V_{OUT} rise time is independent of input voltage or output load. The rise time is dependent on R8 and C9 in the EVM schematic. Table 4 lists the output voltage rise time for four different RC combinations:

Table 4. Soft-Start Circuit Scenarios

R8	C9	Time to 66% of V_{OUT} (+3.3V)	Time to 100% of V_{OUT} (+5V)
1 k Ω	0.1 μ F	0.9 ms	5.8 ms
2 k Ω	0.1 μ F	0.9 ms	6.4 ms
1 k Ω	10 μ F 0.1 μ F	70 ms	542 ms
2 k Ω	10 μ F 0.1 μ F	82 ms	594 ms

The soft-start test was done with a 10-mA resistive load. The resistor was placed directly at the V_{OUT} screw terminals to minimize series inductance. The soft-start event was observed by using an oscilloscope to capture the output rising voltage when the input's + wire is connected to the power supply. A switch is not used due to bouncing. The power supply's internal on/off functionality is also not used to avoid observing the power supply's soft-start (if any). A voltage jump of approximately 2 V is present on V_{OUT} irrespective of the RC network used in the soft-start circuit.

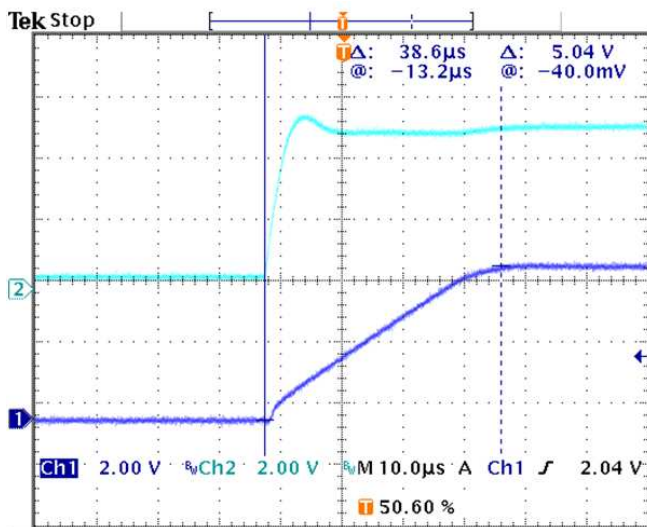

Blue (Ch1) is V_{OUT} and Cyan (CH1) is V_{IN}

Figure 12. V_{OUT} and V_{IN} With no Soft-Start

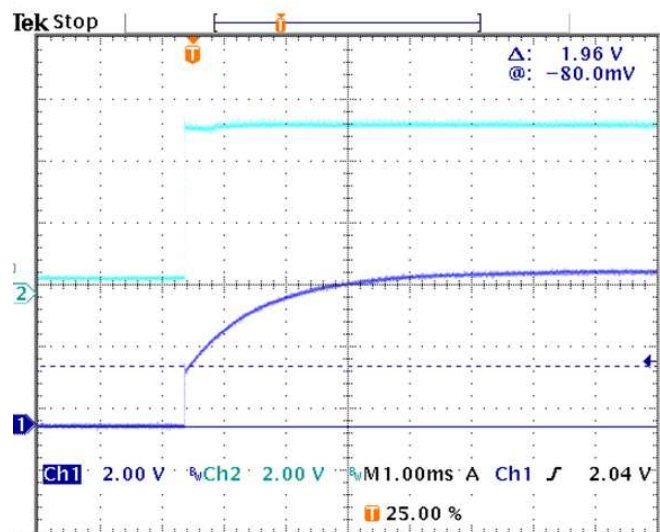

Blue (Ch1) is V_{OUT} and Cyan (CH1) is V_{IN}

Figure 13. V_{OUT} and V_{IN} With Soft-Start Circuit

8.4 Enable/Disable

The LDO can be enabled/disabled by placing a jumper on J4 in the respective position. If driven by an external electrical signal, then the SHDN pin of the TPS7A4501 (pin 2 of J4) should be tied to V_{IN} to turn on the device or when the feature is not used. Conversely, pulling the SHDN pin to ground will turn off the device. The device is in shutdown state by default if the SHDN pin is left floating.

8.5 Output Noise

Output noise is measured using HP3495A and Picotest J2180A low-noise amplifier while the EVM was powered by the Agilent E3631A power supply with a Chroma DC load on the EVM output. The HP3495A was configured for 3-Hz IFBW and 50 samples for averaging. For details on the setup, see the *Output Noise Measurement Setup* document. The following plots show noise in $\mu\text{V}/\sqrt{\text{Hz}}$ vs Frequency without the 20-dB gain of the LNA.

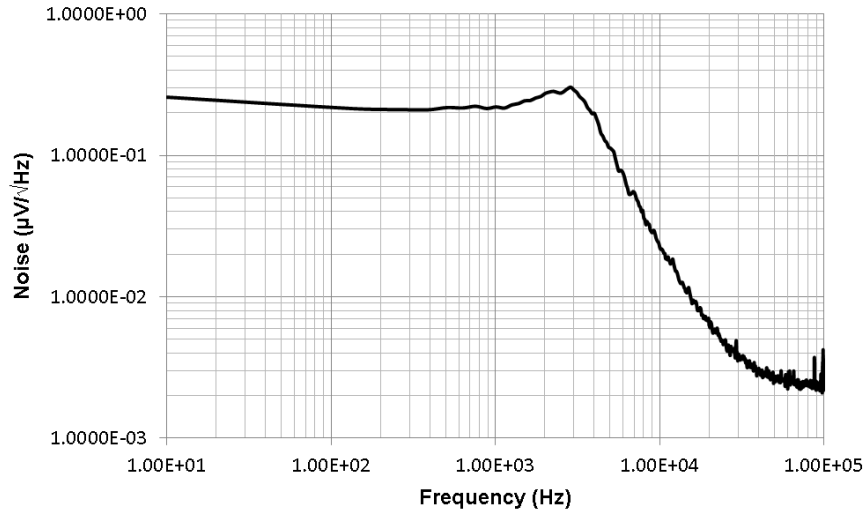

Figure 14. Best-Case RMS Noise (10 Hz - 100 kHz) = 16.86 μV_{rms} , $V_{\text{IN}} = 5.5 \text{ V}$, $V_{\text{OUT}} = 5 \text{ V}$ at no Load

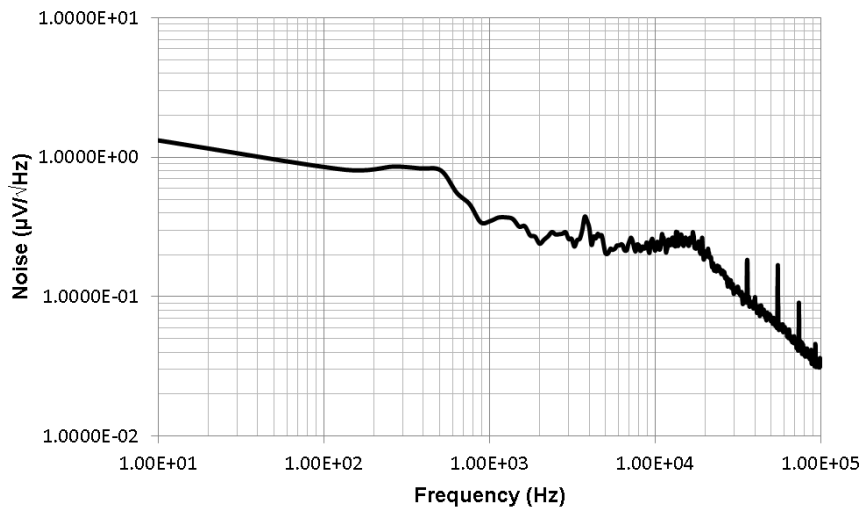

Figure 15. Worst-Case RMS Noise (10 Hz – 100 kHz) = 47.39 μV_{rms} , $V_{\text{IN}} = 5.5 \text{ V}$, $V_{\text{OUT}} = 5 \text{ V}$ at 1.5 A Load

9 Optional Board Modifications

Figure 16 is the schematic of the feedback network.

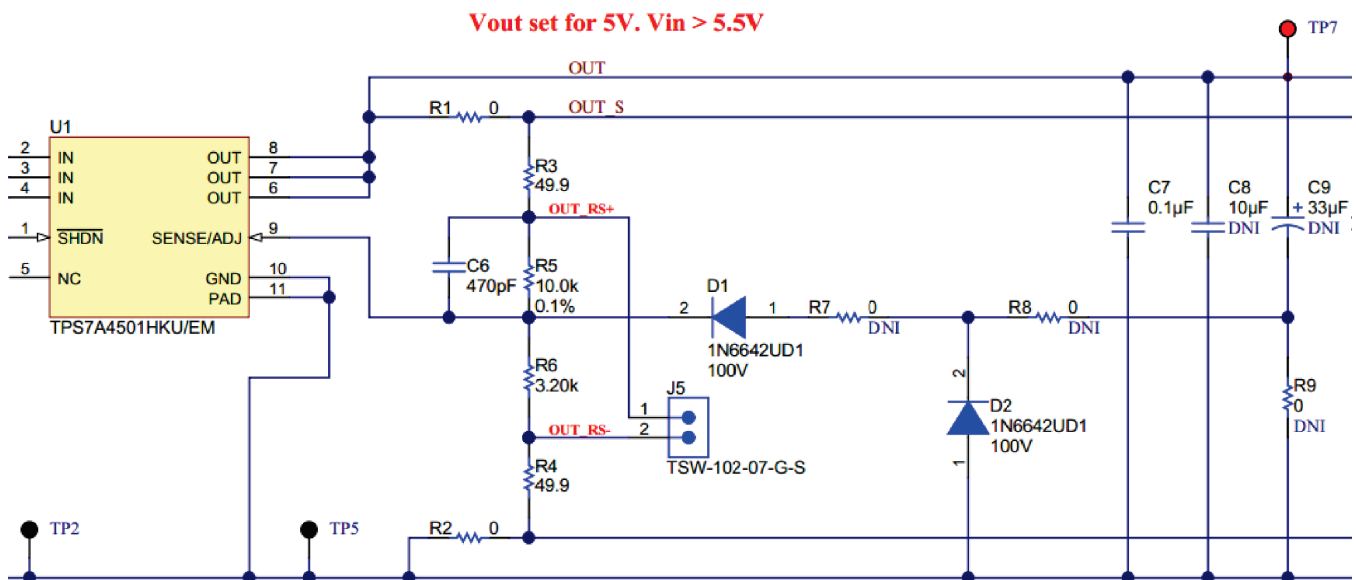

Figure 16. Schematic of the Feedback Network

9.1 Changing the Output Voltage

By default, the EVM is configured for an output voltage of 5 V. This can be changed by swapping out R5 and R6 accordingly. C6 is included for loop stability and to enhance output noise performance.

$$V_{\text{OUT}} = 1.21 \left(1 + \frac{R3 + R5}{R6 + R4} \right) + I_{\text{ADJ}} (R3 + R5) \quad (1)$$

9.2 Remote Output Sense

Two options are provided for connecting a remote sense line to alter the point-of-regulation: via J5 or via J8 pins 2 and 3. To utilize J5, remove R4 and R6 and connect J5 pin 1 to + sense and J5 pin 2 to – sense. To utilize J8, remove R1 and R2 and connect J8 pin 2 to + sense and J8 pin 3 to – sense. Note that J8 pins 2 and 3 are strictly only for sensing; these are optimized for high-current loads.

9.3 Soft-Start Capability

Two diodes (D1 and D2) should be present on the EVM. To use the soft-start feature, short R7, solder a 1-MΩ resistor at R9, and solder a resistor and capacitor at R8 and C9 that will determine the VOUT rise time.

9.4 ESR Stability

Note that R9 is in series with C9. This is provided as a way to measure the LDO stability at various capacitor ESR values by the addition of a resistor. If no additional ESR is desired, R9 should be shorted. Note that this feature cannot be used in conjunction with the soft-start circuitry since both require the use of the R9 and C9 placeholders.

10 Schematic and Bill of Materials

This section contains the [TPS7A4501SPEVM Schematic](#) and bill of materials.

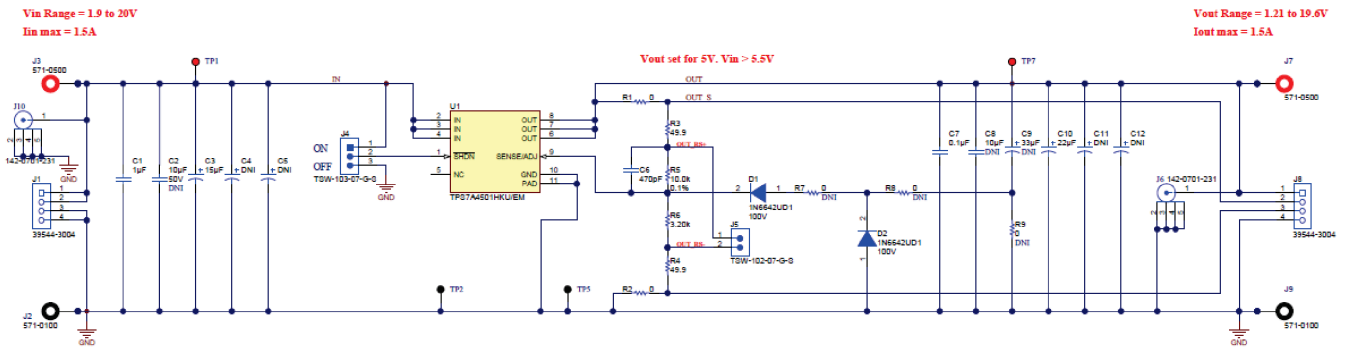

Figure 17. TPS7A4501SPEVM Schematic

Table 5. TPS7H1101SPEVM Bill of Materials

Item No.	Qty	Designator	Manufacturer	Part No.	Description
1	1	C1	AVX	08055C105KAT2A	CAP, CERM, 1uF, 50V, +/-10%, X7R, 0805
2	1	C3	Kemet	T495X156M050ATE300	CAP, TA, 15uF, 50V, +/-20%, 0.3 ohm, SMD
3	1	C6	TDK	CGJ4C2C0G1H471J060AA	CAP, CERM, 470pF, 50V, +/-5%, C0G/NP0, 0805
4	1	C7	Kemet	C1210C104K5RACTU	CAP, CERM, 0.1uF, 50V, +/-10%, X7R, 1210
5	1	C10	Kemet	T495D226K025ATE200	CAP, TA, 22uF, 25V, +/-20%, 0.2 ohm, SMD
6	2	D1, D2	ST Microelectronics	1N6642UD1	Diode, Switching, 100V, 0.3A, 4.77x2.2x2.1 mm
7	3	FID1, FID2, FID3	N/A	N/A	Fiducial mark. There is nothing to buy or mount.
8	4	H1, H2, H3, H4	Keystone	1902C	Standoff, Hex, 0.5"L #4-40 Nylon
9	4	H5, H6, H7, H8	B&F Fastener Supply	NY PMS 440 0025 PH	Machine Screw, Round, #4-40 x 1/4, Nylon, Philips panhead
10	2	J1, J8	Molex	39544-3004	Terminal Block, 4x1, 5.08mm, TH
11	2	J2, J9	DEM Manufacturing	571-0100	Standard Banana Jack, insulated, 10A, black
12	2	J3, J7	DEM Manufacturing	571-0500	Standard Banana Jack, insulated, 10A, red
13	1	J4	Samtec	TSW-103-07-G-S	Header, TH, 100mil, 3x1, Gold plated, 230 mil above insulator
14	1	J5	Samtec	TSW-102-07-G-S	Header, TH, 100mil, 2x1, Gold plated, 230 mil above insulator
15	2	J6, J10	Emerson Network Power	142-0701-231	Connector, TH, SMA
16	1	LBL1	Brady	THT-14-423-10	Thermal Transfer Printable Labels, 0.650" W x 0.200" H - 10,000 per roll
17	2	R1,R2	Yageo America	RC0805JR-070RL	RES, 0 ohm, 5%, 0.125W, 0805
18	2	R3, R4	Yageo America	RT0805BRD0749R9L	RES, 49.9 ohm, 0.1%, 0.125W, 0805
19	1	R5	Yageo America	RT0805BRD0710KL	RES, 10.0k ohm, 0.1%, 0.125W, 0805
20	1	R6	Vishay-Dale	TNPW08053K20BEEN	RES, 3.20k ohm, 0.1%, 0.125W, 0805
21	2	TP1, TP7	Keystone	5000	Test Point, Miniature, Red, TH
22	5	TP2, TP3, TP4, TP5, TP6	Keystone	5001	Test Point, Miniature, Black, TH
23	1	U1	Texas Instruments	TPS7A4501HKU/EM	2.3V to 20V, 1.5-A Low Dropout Voltage Regulator, provided by customer.

STANDARD TERMS AND CONDITIONS FOR EVALUATION MODULES

1. *Delivery:* TI delivers TI evaluation boards, kits, or modules, including any accompanying demonstration software, components, or documentation (collectively, an "EVM" or "EVMs") to the User ("User") in accordance with the terms and conditions set forth herein. Acceptance of the EVM is expressly subject to the following terms and conditions.
 - 1.1 EVMs are intended solely for product or software developers for use in a research and development setting to facilitate feasibility evaluation, experimentation, or scientific analysis of TI semiconductor products. EVMs have no direct function and are not finished products. EVMs shall not be directly or indirectly assembled as a part or subassembly in any finished product. For clarification, any software or software tools provided with the EVM ("Software") shall not be subject to the terms and conditions set forth herein but rather shall be subject to the applicable terms and conditions that accompany such Software
 - 1.2 EVMs are not intended for consumer or household use. EVMs may not be sold, sublicensed, leased, rented, loaned, assigned, or otherwise distributed for commercial purposes by Users, in whole or in part, or used in any finished product or production system.
2. *Limited Warranty and Related Remedies/Disclaimers:*
 - 2.1 These terms and conditions do not apply to Software. The warranty, if any, for Software is covered in the applicable Software License Agreement.
 - 2.2 TI warrants that the TI EVM will conform to TI's published specifications for ninety (90) days after the date TI delivers such EVM to User. Notwithstanding the foregoing, TI shall not be liable for any defects that are caused by neglect, misuse or mistreatment by an entity other than TI, including improper installation or testing, or for any EVMs that have been altered or modified in any way by an entity other than TI. Moreover, TI shall not be liable for any defects that result from User's design, specifications or instructions for such EVMs. Testing and other quality control techniques are used to the extent TI deems necessary or as mandated by government requirements. TI does not test all parameters of each EVM.
 - 2.3 If any EVM fails to conform to the warranty set forth above, TI's sole liability shall be at its option to repair or replace such EVM, or credit User's account for such EVM. TI's liability under this warranty shall be limited to EVMs that are returned during the warranty period to the address designated by TI and that are determined by TI not to conform to such warranty. If TI elects to repair or replace such EVM, TI shall have a reasonable time to repair such EVM or provide replacements. Repaired EVMs shall be warranted for the remainder of the original warranty period. Replaced EVMs shall be warranted for a new full ninety (90) day warranty period.
3. *Regulatory Notices:*
 - 3.1 *United States*
 - 3.1.1 *Notice applicable to EVMs not FCC-Approved:*

This kit is designed to allow product developers to evaluate electronic components, circuitry, or software associated with the kit to determine whether to incorporate such items in a finished product and software developers to write software applications for use with the end product. This kit is not a finished product and when assembled may not be resold or otherwise marketed unless all required FCC equipment authorizations are first obtained. Operation is subject to the condition that this product not cause harmful interference to licensed radio stations and that this product accept harmful interference. Unless the assembled kit is designed to operate under part 15, part 18 or part 95 of this chapter, the operator of the kit must operate under the authority of an FCC license holder or must secure an experimental authorization under part 5 of this chapter.
 - 3.1.2 *For EVMs annotated as FCC – FEDERAL COMMUNICATIONS COMMISSION Part 15 Compliant:*

CAUTION

This device complies with part 15 of the FCC Rules. Operation is subject to the following two conditions: (1) This device may not cause harmful interference, and (2) this device must accept any interference received, including interference that may cause undesired operation.

Changes or modifications not expressly approved by the party responsible for compliance could void the user's authority to operate the equipment.

FCC Interference Statement for Class A EVM devices

NOTE: This equipment has been tested and found to comply with the limits for a Class A digital device, pursuant to part 15 of the FCC Rules. These limits are designed to provide reasonable protection against harmful interference when the equipment is operated in a commercial environment. This equipment generates, uses, and can radiate radio frequency energy and, if not installed and used in accordance with the instruction manual, may cause harmful interference to radio communications. Operation of this equipment in a residential area is likely to cause harmful interference in which case the user will be required to correct the interference at his own expense.

FCC Interference Statement for Class B EVM devices

NOTE: This equipment has been tested and found to comply with the limits for a Class B digital device, pursuant to part 15 of the FCC Rules. These limits are designed to provide reasonable protection against harmful interference in a residential installation. This equipment generates, uses and can radiate radio frequency energy and, if not installed and used in accordance with the instructions, may cause harmful interference to radio communications. However, there is no guarantee that interference will not occur in a particular installation. If this equipment does cause harmful interference to radio or television reception, which can be determined by turning the equipment off and on, the user is encouraged to try to correct the interference by one or more of the following measures:

- Reorient or relocate the receiving antenna.
- Increase the separation between the equipment and receiver.
- Connect the equipment into an outlet on a circuit different from that to which the receiver is connected.
- Consult the dealer or an experienced radio/TV technician for help.

3.2 Canada

3.2.1 For EVMs issued with an Industry Canada Certificate of Conformance to RSS-210

Concerning EVMs Including Radio Transmitters:

This device complies with Industry Canada license-exempt RSS standard(s). Operation is subject to the following two conditions: (1) this device may not cause interference, and (2) this device must accept any interference, including interference that may cause undesired operation of the device.

Concernant les EVMs avec appareils radio:

Le présent appareil est conforme aux CNR d'Industrie Canada applicables aux appareils radio exempts de licence. L'exploitation est autorisée aux deux conditions suivantes: (1) l'appareil ne doit pas produire de brouillage, et (2) l'utilisateur de l'appareil doit accepter tout brouillage radioélectrique subi, même si le brouillage est susceptible d'en compromettre le fonctionnement.

Concerning EVMs Including Detachable Antennas:

Under Industry Canada regulations, this radio transmitter may only operate using an antenna of a type and maximum (or lesser) gain approved for the transmitter by Industry Canada. To reduce potential radio interference to other users, the antenna type and its gain should be so chosen that the equivalent isotropically radiated power (e.i.r.p.) is not more than that necessary for successful communication. This radio transmitter has been approved by Industry Canada to operate with the antenna types listed in the user guide with the maximum permissible gain and required antenna impedance for each antenna type indicated. Antenna types not included in this list, having a gain greater than the maximum gain indicated for that type, are strictly prohibited for use with this device.

Concernant les EVMs avec antennes détachables

Conformément à la réglementation d'Industrie Canada, le présent émetteur radio peut fonctionner avec une antenne d'un type et d'un gain maximal (ou inférieur) approuvé pour l'émetteur par Industrie Canada. Dans le but de réduire les risques de brouillage radioélectrique à l'intention des autres utilisateurs, il faut choisir le type d'antenne et son gain de sorte que la puissance isotrope rayonnée équivalente (p.i.r.e.) ne dépasse pas l'intensité nécessaire à l'établissement d'une communication satisfaisante. Le présent émetteur radio a été approuvé par Industrie Canada pour fonctionner avec les types d'antenne énumérés dans le manuel d'usage et ayant un gain admissible maximal et l'impédance requise pour chaque type d'antenne. Les types d'antenne non inclus dans cette liste, ou dont le gain est supérieur au gain maximal indiqué, sont strictement interdits pour l'exploitation de l'émetteur.

3.3 Japan

3.3.1 *Notice for EVMs delivered in Japan:* Please see http://www.tij.co.jp/lstds/ti_ja/general/eStore/notice_01.page 日本国内に輸入される評価用キット、ボードについては、次のところをご覧ください。
http://www.tij.co.jp/lstds/ti_ja/general/eStore/notice_01.page

3.3.2 *Notice for Users of EVMs Considered "Radio Frequency Products" in Japan:* EVMs entering Japan may not be certified by TI as conforming to Technical Regulations of Radio Law of Japan.

If User uses EVMs in Japan, not certified to Technical Regulations of Radio Law of Japan, User is required by Radio Law of Japan to follow the instructions below with respect to EVMs:

1. Use EVMs in a shielded room or any other test facility as defined in the notification #173 issued by Ministry of Internal Affairs and Communications on March 28, 2006, based on Sub-section 1.1 of Article 6 of the Ministry's Rule for Enforcement of Radio Law of Japan,
2. Use EVMs only after User obtains the license of Test Radio Station as provided in Radio Law of Japan with respect to EVMs, or
3. Use of EVMs only after User obtains the Technical Regulations Conformity Certification as provided in Radio Law of Japan with respect to EVMs. Also, do not transfer EVMs, unless User gives the same notice above to the transferee. Please note that if User does not follow the instructions above, User will be subject to penalties of Radio Law of Japan.

【無線電波を送信する製品の開発キットをお使いになる際の注意事項】 開発キットの中には技術基準適合証明を受けていないものがあります。技術適合証明を受けていないもののご使用に際しては、電波法遵守のため、以下のいずれかの措置を取っていただく必要がありますのでご注意ください。

1. 電波法施行規則第6条第1項第1号に基づく平成18年3月28日総務省告示第173号で定められた電波暗室等の試験設備でご使用いただく。
2. 実験局の免許を取得後ご使用いただく。
3. 技術基準適合証明を取得後ご使用いただく。

なお、本製品は、上記の「ご使用にあたっての注意」を譲渡先、移転先に通知しない限り、譲渡、移転できないものとします。

上記を遵守頂けない場合は、電波法の罰則が適用される可能性があることをご留意ください。日本テキサス・インスツルメンツ株式会社
東京都新宿区西新宿 6 丁目 2 4 番 1 号
西新宿三井ビル

3.3.3 *Notice for EVMs for Power Line Communication:* Please see http://www.tij.co.jp/llds/ti_ja/general/eStore/notice_02.page
電力線搬送波通信についての開発キットをお使いになる際の注意事項については、次のところをご覧ください。http://www.tij.co.jp/llds/ti_ja/general/eStore/notice_02.page

4 *EVM Use Restrictions and Warnings:*

4.1 EVMS ARE NOT FOR USE IN FUNCTIONAL SAFETY AND/OR SAFETY CRITICAL EVALUATIONS, INCLUDING BUT NOT LIMITED TO EVALUATIONS OF LIFE SUPPORT APPLICATIONS.

4.2 User must read and apply the user guide and other available documentation provided by TI regarding the EVM prior to handling or using the EVM, including without limitation any warning or restriction notices. The notices contain important safety information related to, for example, temperatures and voltages.

4.3 *Safety-Related Warnings and Restrictions:*

4.3.1 User shall operate the EVM within TI's recommended specifications and environmental considerations stated in the user guide, other available documentation provided by TI, and any other applicable requirements and employ reasonable and customary safeguards. Exceeding the specified performance ratings and specifications (including but not limited to input and output voltage, current, power, and environmental ranges) for the EVM may cause personal injury or death, or property damage. If there are questions concerning performance ratings and specifications, User should contact a TI field representative prior to connecting interface electronics including input power and intended loads. Any loads applied outside of the specified output range may also result in unintended and/or inaccurate operation and/or possible permanent damage to the EVM and/or interface electronics. Please consult the EVM user guide prior to connecting any load to the EVM output. If there is uncertainty as to the load specification, please contact a TI field representative. During normal operation, even with the inputs and outputs kept within the specified allowable ranges, some circuit components may have elevated case temperatures. These components include but are not limited to linear regulators, switching transistors, pass transistors, current sense resistors, and heat sinks, which can be identified using the information in the associated documentation. When working with the EVM, please be aware that the EVM may become very warm.

4.3.2 EVMs are intended solely for use by technically qualified, professional electronics experts who are familiar with the dangers and application risks associated with handling electrical mechanical components, systems, and subsystems. User assumes all responsibility and liability for proper and safe handling and use of the EVM by User or its employees, affiliates, contractors or designees. User assumes all responsibility and liability to ensure that any interfaces (electronic and/or mechanical) between the EVM and any human body are designed with suitable isolation and means to safely limit accessible leakage currents to minimize the risk of electrical shock hazard. User assumes all responsibility and liability for any improper or unsafe handling or use of the EVM by User or its employees, affiliates, contractors or designees.

4.4 User assumes all responsibility and liability to determine whether the EVM is subject to any applicable international, federal, state, or local laws and regulations related to User's handling and use of the EVM and, if applicable, User assumes all responsibility and liability for compliance in all respects with such laws and regulations. User assumes all responsibility and liability for proper disposal and recycling of the EVM consistent with all applicable international, federal, state, and local requirements.

5. *Accuracy of Information:* To the extent TI provides information on the availability and function of EVMs, TI attempts to be as accurate as possible. However, TI does not warrant the accuracy of EVM descriptions, EVM availability or other information on its websites as accurate, complete, reliable, current, or error-free.

6. *Disclaimers:*

6.1 EXCEPT AS SET FORTH ABOVE, EVMS AND ANY WRITTEN DESIGN MATERIALS PROVIDED WITH THE EVM (AND THE DESIGN OF THE EVM ITSELF) ARE PROVIDED "AS IS" AND "WITH ALL FAULTS." TI DISCLAIMS ALL OTHER WARRANTIES, EXPRESS OR IMPLIED, REGARDING SUCH ITEMS, INCLUDING BUT NOT LIMITED TO ANY IMPLIED WARRANTIES OF MERCHANTABILITY OR FITNESS FOR A PARTICULAR PURPOSE OR NON-INFRINGEMENT OF ANY THIRD PARTY PATENTS, COPYRIGHTS, TRADE SECRETS OR OTHER INTELLECTUAL PROPERTY RIGHTS.

6.2 EXCEPT FOR THE LIMITED RIGHT TO USE THE EVM SET FORTH HEREIN, NOTHING IN THESE TERMS AND CONDITIONS SHALL BE CONSTRUED AS GRANTING OR CONFERRING ANY RIGHTS BY LICENSE, PATENT, OR ANY OTHER INDUSTRIAL OR INTELLECTUAL PROPERTY RIGHT OF TI, ITS SUPPLIERS/LICENSORS OR ANY OTHER THIRD PARTY, TO USE THE EVM IN ANY FINISHED END-USER OR READY-TO-USE FINAL PRODUCT, OR FOR ANY INVENTION, DISCOVERY OR IMPROVEMENT MADE, CONCEIVED OR ACQUIRED PRIOR TO OR AFTER DELIVERY OF THE EVM.

7. *USER'S INDEMNITY OBLIGATIONS AND REPRESENTATIONS.* USER WILL DEFEND, INDEMNIFY AND HOLD TI, ITS LICENSORS AND THEIR REPRESENTATIVES HARMLESS FROM AND AGAINST ANY AND ALL CLAIMS, DAMAGES, LOSSES, EXPENSES, COSTS AND LIABILITIES (COLLECTIVELY, "CLAIMS") ARISING OUT OF OR IN CONNECTION WITH ANY HANDLING OR USE OF THE EVM THAT IS NOT IN ACCORDANCE WITH THESE TERMS AND CONDITIONS. THIS OBLIGATION SHALL APPLY WHETHER CLAIMS ARISE UNDER STATUTE, REGULATION, OR THE LAW OF TORT, CONTRACT OR ANY OTHER LEGAL THEORY, AND EVEN IF THE EVM FAILS TO PERFORM AS DESCRIBED OR EXPECTED.

8. *Limitations on Damages and Liability:*

8.1 *General Limitations.* IN NO EVENT SHALL TI BE LIABLE FOR ANY SPECIAL, COLLATERAL, INDIRECT, PUNITIVE, INCIDENTAL, CONSEQUENTIAL, OR EXEMPLARY DAMAGES IN CONNECTION WITH OR ARISING OUT OF THESE TERMS AND CONDITIONS OR THE USE OF THE EVMS PROVIDED HEREUNDER, REGARDLESS OF WHETHER TI HAS BEEN ADVISED OF THE POSSIBILITY OF SUCH DAMAGES. EXCLUDED DAMAGES INCLUDE, BUT ARE NOT LIMITED TO, COST OF REMOVAL OR REINSTALLATION, ANCILLARY COSTS TO THE PROCUREMENT OF SUBSTITUTE GOODS OR SERVICES, RETESTING, OUTSIDE COMPUTER TIME, LABOR COSTS, LOSS OF GOODWILL, LOSS OF PROFITS, LOSS OF SAVINGS, LOSS OF USE, LOSS OF DATA, OR BUSINESS INTERRUPTION. NO CLAIM, SUIT OR ACTION SHALL BE BROUGHT AGAINST TI MORE THAN ONE YEAR AFTER THE RELATED CAUSE OF ACTION HAS OCCURRED.

8.2 *Specific Limitations.* IN NO EVENT SHALL TI'S AGGREGATE LIABILITY FROM ANY WARRANTY OR OTHER OBLIGATION ARISING OUT OF OR IN CONNECTION WITH THESE TERMS AND CONDITIONS, OR ANY USE OF ANY TI EVM PROVIDED HEREUNDER, EXCEED THE TOTAL AMOUNT PAID TO TI FOR THE PARTICULAR UNITS SOLD UNDER THESE TERMS AND CONDITIONS WITH RESPECT TO WHICH LOSSES OR DAMAGES ARE CLAIMED. THE EXISTENCE OF MORE THAN ONE CLAIM AGAINST THE PARTICULAR UNITS SOLD TO USER UNDER THESE TERMS AND CONDITIONS SHALL NOT ENLARGE OR EXTEND THIS LIMIT.

9. *Return Policy.* Except as otherwise provided, TI does not offer any refunds, returns, or exchanges. Furthermore, no return of EVM(s) will be accepted if the package has been opened and no return of the EVM(s) will be accepted if they are damaged or otherwise not in a resalable condition. If User feels it has been incorrectly charged for the EVM(s) it ordered or that delivery violates the applicable order, User should contact TI. All refunds will be made in full within thirty (30) working days from the return of the components(s), excluding any postage or packaging costs.

10. *Governing Law:* These terms and conditions shall be governed by and interpreted in accordance with the laws of the State of Texas, without reference to conflict-of-laws principles. User agrees that non-exclusive jurisdiction for any dispute arising out of or relating to these terms and conditions lies within courts located in the State of Texas and consents to venue in Dallas County, Texas. Notwithstanding the foregoing, any judgment may be enforced in any United States or foreign court, and TI may seek injunctive relief in any United States or foreign court.

IMPORTANT NOTICE

Texas Instruments Incorporated and its subsidiaries (TI) reserve the right to make corrections, enhancements, improvements and other changes to its semiconductor products and services per JESD46, latest issue, and to discontinue any product or service per JESD48, latest issue. Buyers should obtain the latest relevant information before placing orders and should verify that such information is current and complete. All semiconductor products (also referred to herein as "components") are sold subject to TI's terms and conditions of sale supplied at the time of order acknowledgment.

TI warrants performance of its components to the specifications applicable at the time of sale, in accordance with the warranty in TI's terms and conditions of sale of semiconductor products. Testing and other quality control techniques are used to the extent TI deems necessary to support this warranty. Except where mandated by applicable law, testing of all parameters of each component is not necessarily performed.

TI assumes no liability for applications assistance or the design of Buyers' products. Buyers are responsible for their products and applications using TI components. To minimize the risks associated with Buyers' products and applications, Buyers should provide adequate design and operating safeguards.

TI does not warrant or represent that any license, either express or implied, is granted under any patent right, copyright, mask work right, or other intellectual property right relating to any combination, machine, or process in which TI components or services are used. Information published by TI regarding third-party products or services does not constitute a license to use such products or services or a warranty or endorsement thereof. Use of such information may require a license from a third party under the patents or other intellectual property of the third party, or a license from TI under the patents or other intellectual property of TI.

Reproduction of significant portions of TI information in TI data books or data sheets is permissible only if reproduction is without alteration and is accompanied by all associated warranties, conditions, limitations, and notices. TI is not responsible or liable for such altered documentation. Information of third parties may be subject to additional restrictions.

Resale of TI components or services with statements different from or beyond the parameters stated by TI for that component or service voids all express and any implied warranties for the associated TI component or service and is an unfair and deceptive business practice. TI is not responsible or liable for any such statements.

Buyer acknowledges and agrees that it is solely responsible for compliance with all legal, regulatory and safety-related requirements concerning its products, and any use of TI components in its applications, notwithstanding any applications-related information or support that may be provided by TI. Buyer represents and agrees that it has all the necessary expertise to create and implement safeguards which anticipate dangerous consequences of failures, monitor failures and their consequences, lessen the likelihood of failures that might cause harm and take appropriate remedial actions. Buyer will fully indemnify TI and its representatives against any damages arising out of the use of any TI components in safety-critical applications.

In some cases, TI components may be promoted specifically to facilitate safety-related applications. With such components, TI's goal is to help enable customers to design and create their own end-product solutions that meet applicable functional safety standards and requirements. Nonetheless, such components are subject to these terms.

No TI components are authorized for use in FDA Class III (or similar life-critical medical equipment) unless authorized officers of the parties have executed a special agreement specifically governing such use.

Only those TI components which TI has specifically designated as military grade or "enhanced plastic" are designed and intended for use in military/aerospace applications or environments. Buyer acknowledges and agrees that any military or aerospace use of TI components which have **not** been so designated is solely at the Buyer's risk, and that Buyer is solely responsible for compliance with all legal and regulatory requirements in connection with such use.

TI has specifically designated certain components as meeting ISO/TS16949 requirements, mainly for automotive use. In any case of use of non-designated products, TI will not be responsible for any failure to meet ISO/TS16949.

Products

Audio	www.ti.com/audio
Amplifiers	amplifier.ti.com
Data Converters	dataconverter.ti.com
DLP® Products	www.dlp.com
DSP	dsp.ti.com
Clocks and Timers	www.ti.com/clocks
Interface	interface.ti.com
Logic	logic.ti.com
Power Mgmt	power.ti.com
Microcontrollers	microcontroller.ti.com
RFID	www.ti-rfid.com
OMAP Applications Processors	www.ti.com/omap
Wireless Connectivity	www.ti.com/wirelessconnectivity

Applications

Automotive and Transportation	www.ti.com/automotive
Communications and Telecom	www.ti.com/communications
Computers and Peripherals	www.ti.com/computers
Consumer Electronics	www.ti.com/consumer-apps
Energy and Lighting	www.ti.com/energy
Industrial	www.ti.com/industrial
Medical	www.ti.com/medical
Security	www.ti.com/security
Space, Avionics and Defense	www.ti.com/space-avionics-defense
Video and Imaging	www.ti.com/video

TI E2E Community

e2e.ti.com