

$P_D = 2\text{ W}$
Transient Voltage Suppressor
SJPZ-N Series

Description

The SJPZ-N series are power Zener diodes designed for the protection of automotive electronic units, especially from the surge generated during load dump conditions and voltage transients induced by inductive loads. The package of the IC has high dissipation and high surge capability.

Features

- AEC-Q101 Qualified
- Meets the Surge Protection Requirements in ISO7637-2 Standard (Pulse 1-3)
- High Reliability and Automotive Requirement
- High Surge Capability
- Flammability UL94V-0 (Equivalent)
- Bare Lead Frame: Pb-free (RoHS Compliant)

Applications

Protection of sensitive electronic equipment in passenger cars, trucks, vans, and buses:

- Engine Control Units
- Electric Control Units
- Braking System
- Power Steering System
- Airbag System
- Audio System
- Infotainment System

Package
SJP

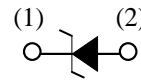
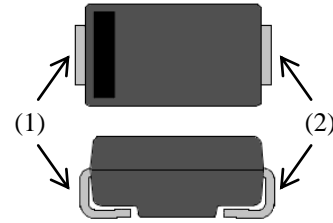

(1) Cathode
(2) Anode

Not to scale

Selection Guide

Part Number	V_Z		P_{RSM}^*	P_D
	Min.	Max.		
SJPZ-N18	16.8 V	19.1 V	500 W	2 W
SJPZ-N27	25.1 V	28.9 V		
SJPZ-N33	31.0 V	35.0 V		
SJPZ-N40	37.8 V	42.2 V		

*500 μ s, single block pulse

Typical Application

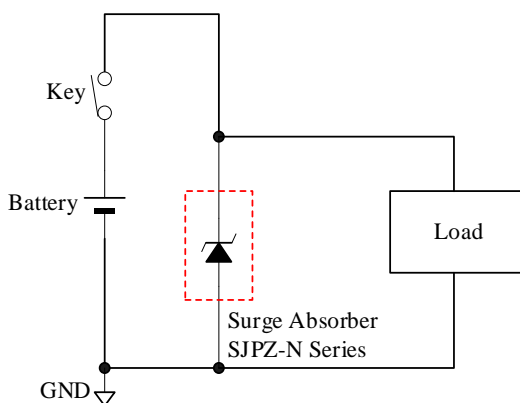

Contents

Description ----- 1
Contents ----- 2
Absolute Maximum Ratings ----- 3
Electrical Characteristics ----- 4
SJPZ-N18 Rating and Characteristic Curves ----- 5
SJPZ-N27 Rating and Characteristic Curves ----- 7
SJPZ-N33 Rating and Characteristic Curves ----- 9
SJPZ-N40 Rating and Characteristic Curves ----- 11
Physical Dimensions ----- 13
Marking Diagram ----- 14
Important Notes ----- 15

SJPZ-N Series

Absolute Maximum Ratings

Unless otherwise specified, $T_A = 25\text{ }^\circ\text{C}$.

Parameter	Symbol	Conditions	Rating	Unit	Remarks
Power Dissipation ⁽¹⁾	P_D	Lead temperature ⁽²⁾	2	W	
DC Blocking Voltage	V_{DC}	—	13	V	SJPZ-N18
			20		SJPZ-N27
			25		SJPZ-N33
			30		SJPZ-N40
Peak Reverse Power	P_{RSM}	500 μs , single block pulse	500	W	
Junction Temperature	T_J	—	-55 to 150	$^\circ\text{C}$	
Storage Temperature	T_{STG}	—	-55 to 150	$^\circ\text{C}$	

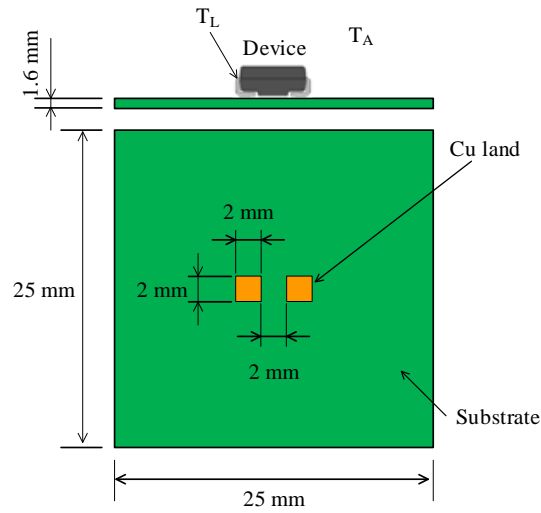

Figure 1. Lead Temperature Measurement Conditions

⁽¹⁾ See Figure 2.

⁽²⁾ See Figure 1.

SJPZ-N Series

Electrical Characteristics

Unless otherwise specified, $T_A = 25\text{ }^\circ\text{C}$.

Parameter	Symbol	Conditions	Min.	Typ.	Max.	Unit	Remarks
Forward Voltage Drop	V_F	$I_F = 2\text{ A}$	—	—	1.20	V	
Reverse Leakage Current	I_R	$V_R = 13\text{ V}$	—	—	1	μA	SJPZ-N18
		$V_R = 20\text{ V}$	—	—	1		SJPZ-N27
		$V_R = 25\text{ V}$	—	—	1		SJPZ-N33
		$V_R = 30\text{ V}$	—	—	1		SJPZ-N40
Breakdown Voltage	V_Z	$I_Z = 1\text{ mA}$	16.8	—	19.1	V	SJPZ-N18
			25.1	—	28.9		SJPZ-N27
			31.0	—	35.0		SJPZ-N33
			37.8	—	42.2		SJPZ-N40
Breakdown Voltage Temperature Coefficient	r_Z	$I_Z = 1\text{ mA}$	—	13	—	$\text{mV}/^\circ\text{C}$	SJPZ-N18
			—	23	—		SJPZ-N27
			—	29	—		SJPZ-N33
			—	35	—		SJPZ-N40
Breakdown Region Equivalent Resistance	R_Z	$I_Z = 10\text{ mA to }20\text{ mA}$	—	2	—	Ω	
			—	4	—		
			—	5	—		
			—	7	—		
Thermal Resistance	$R_{th(J-L)}$	⁽³⁾	—	20	—	$^\circ\text{C}/\text{W}$	

⁽³⁾ $R_{th(J-L)}$ is thermal resistance between junction and lead. Lead temperature is measured as shown in Figure 1.

SJPZ-N18 Rating and Characteristic Curves

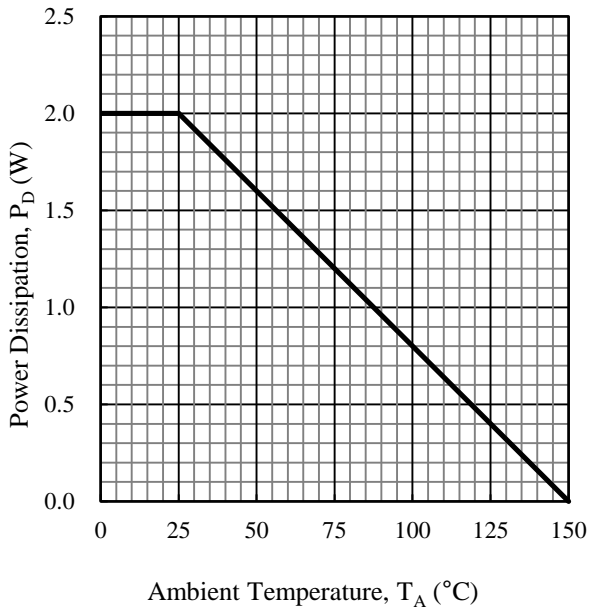

Figure 2. SJPZ-N18 Power Dissipation Curves⁽⁴⁾

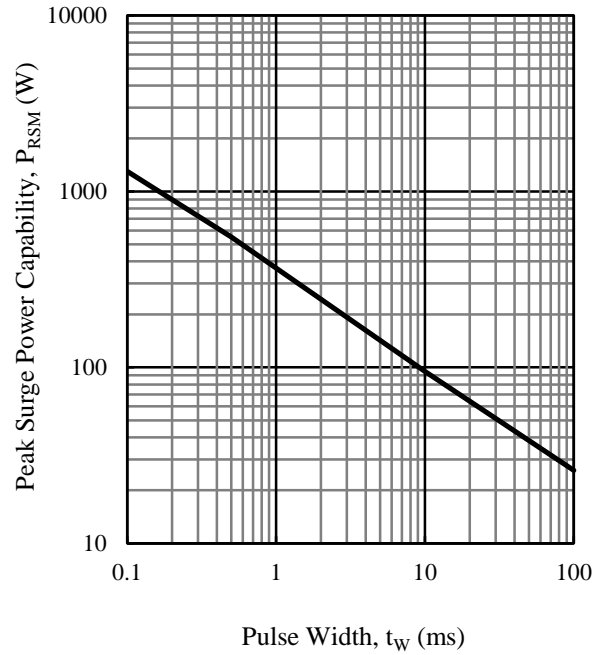

Figure 3. SJPZ-N18 Peak Surge Reverse Power Capability⁽⁵⁾

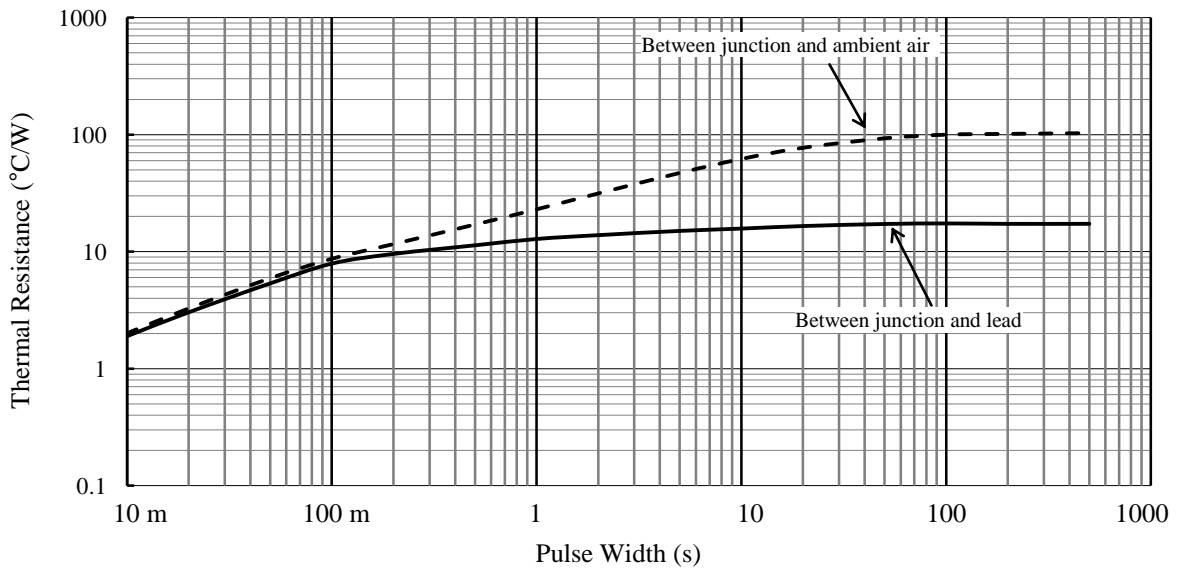

Figure 4. SJPZ-N18 Typical Transient Thermal Resistance⁽⁶⁾

⁽⁴⁾ See Figure 1 for the measurement conditions of the lead temperature.

⁽⁵⁾ t_W is single block pulse.

⁽⁶⁾ See Figure 1 for the measurement conditions of the lead temperature.

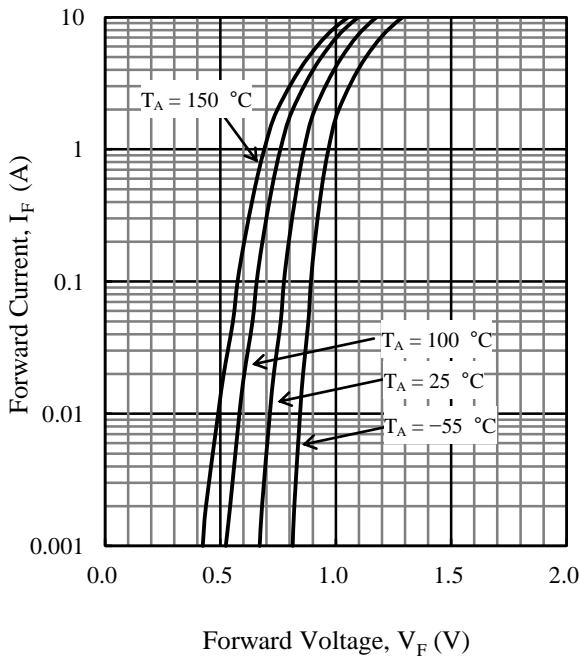

Figure 5. SJPZ-N18 Typical Characteristics: I_F vs. V_F

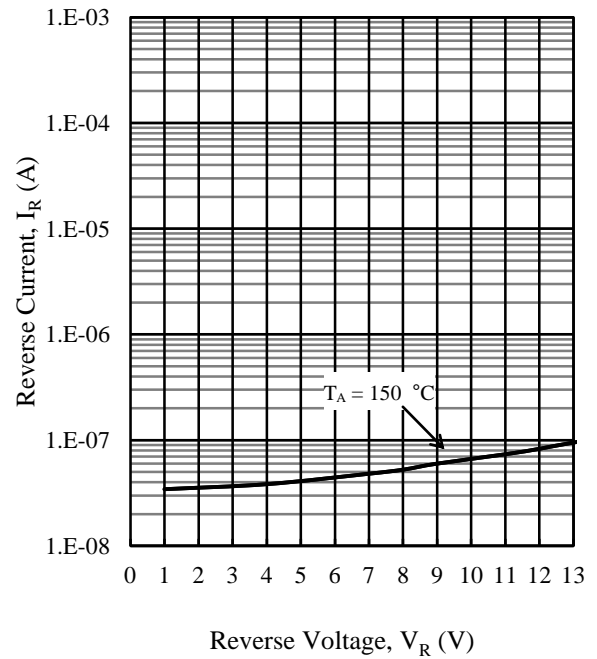

Figure 6. SJPZ-N18 Typical Characteristics: I_R vs. V_R

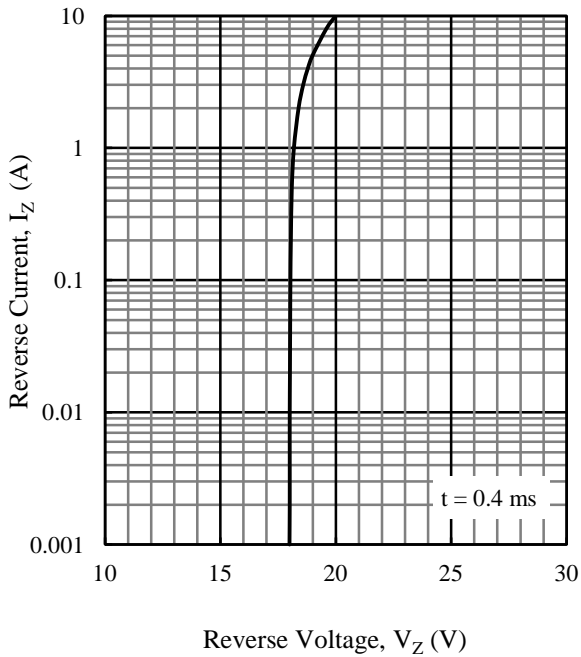

Figure 7. SJPZ-N18 Typical Characteristics: I_Z vs. V_Z

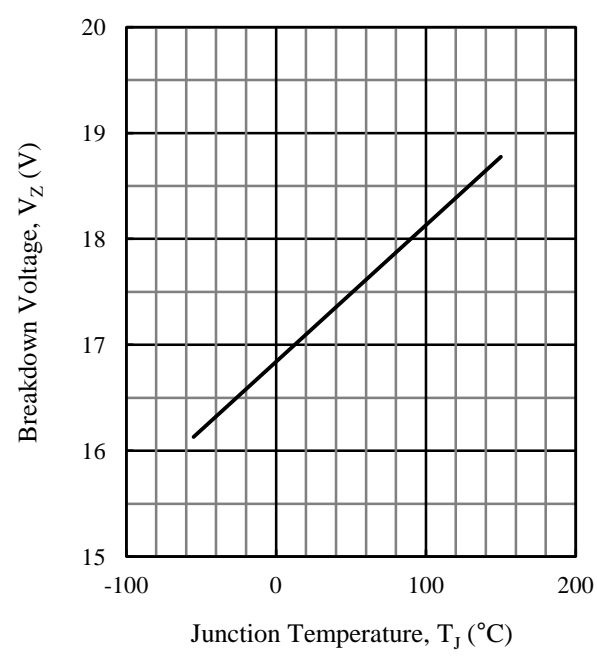

Figure 8. SJPZ-N18 Typical Characteristics: V_Z vs. T_J

SJPZ-N27 Rating and Characteristic Curves

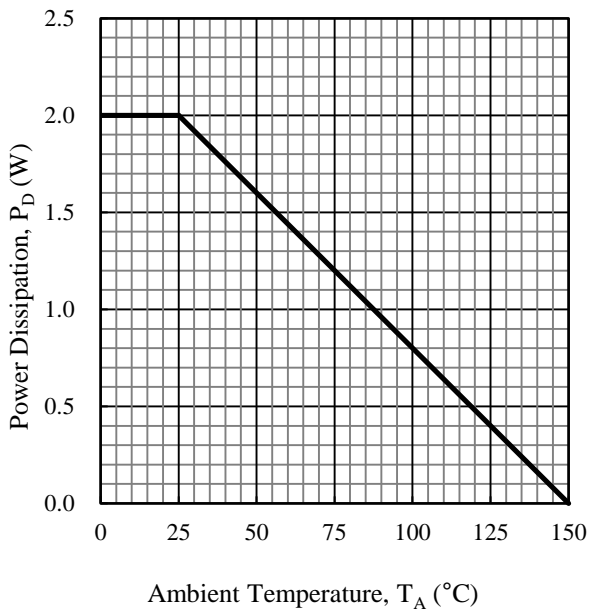

Figure 9. SJPZ-N27 Power Dissipation Curves⁽⁷⁾

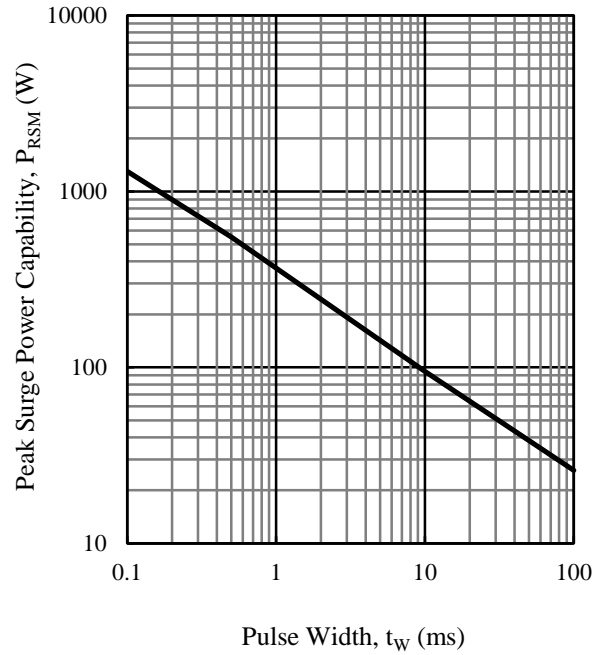

Figure 10. SJPZ-N27 Peak Surge Reverse Power Capability⁽⁸⁾

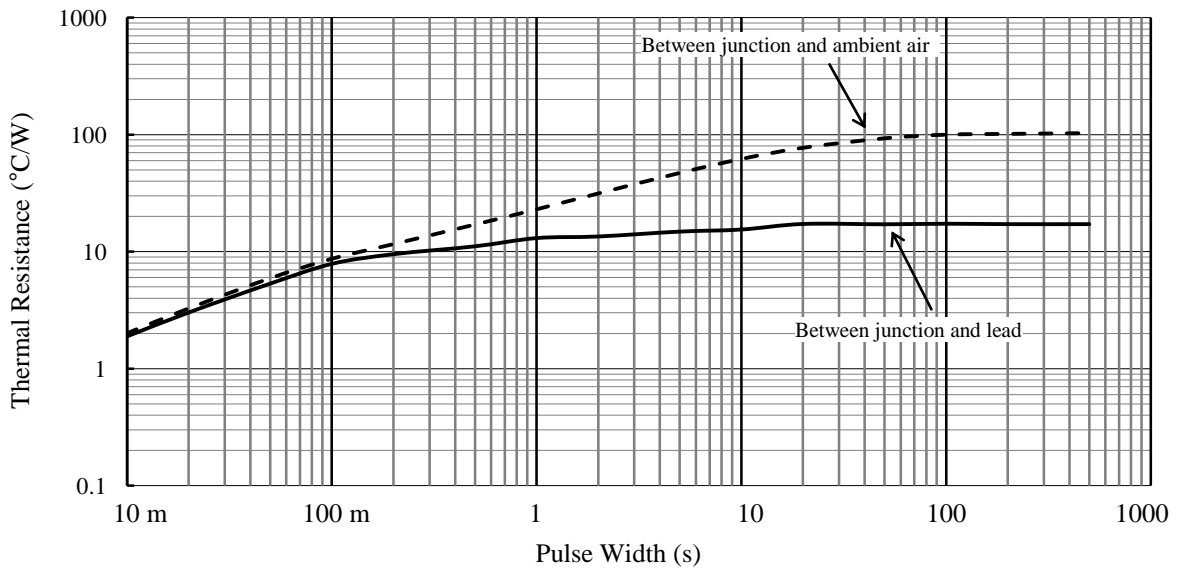

Figure 11. SJPZ-N27 Typical Transient Thermal Resistance⁽⁹⁾

⁽⁷⁾ See Figure 1 for the measurement conditions of the lead temperature.

⁽⁸⁾ t_W is single block pulse..

⁽⁹⁾ See Figure 1 for the measurement conditions of the lead temperature.

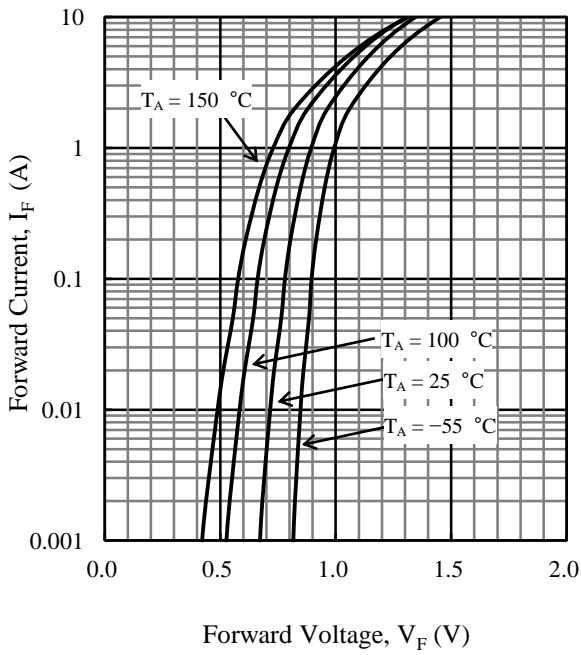

Figure 12. SJPZ-N27 Typical Characteristics: I_F vs. V_F

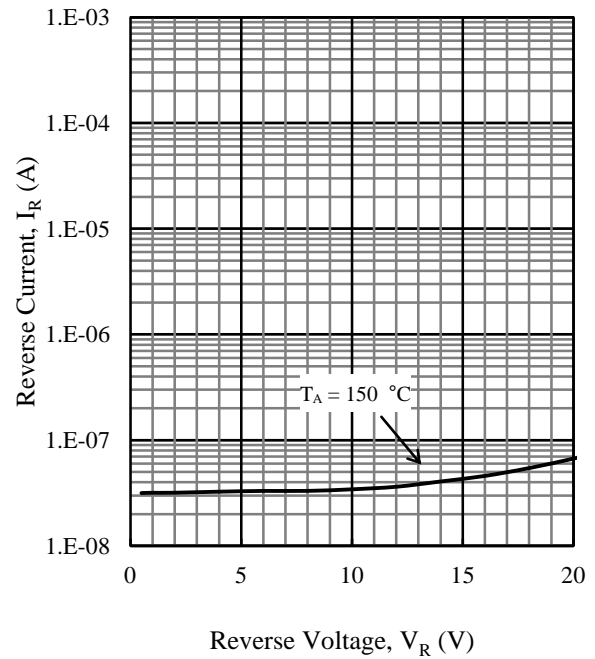

Figure 13. SJPZ-N27 Typical Characteristics: I_R vs. V_R

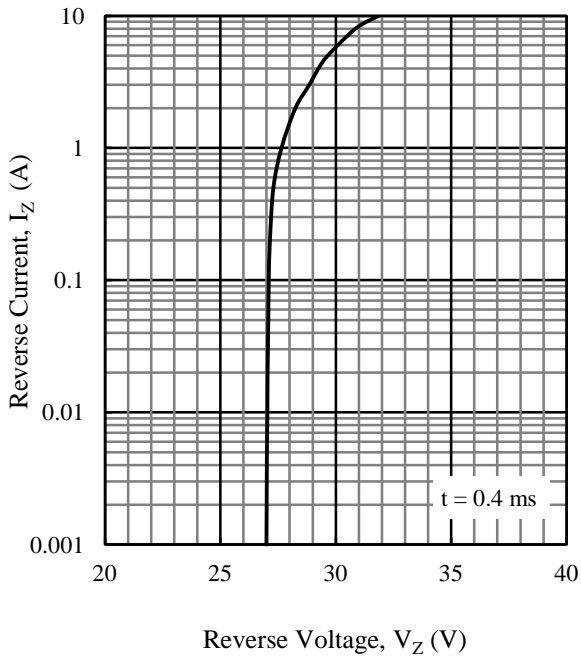

Figure 14. SJPZ-N27 Typical Characteristics: I_Z vs. V_Z

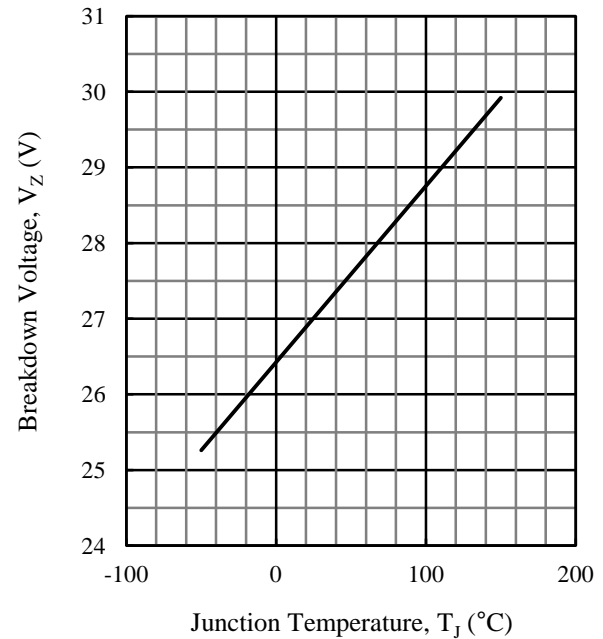

Figure 15. SJPZ-N27 Typical Characteristics: V_Z vs. T_J

SJPZ-N33 Rating and Characteristic Curves

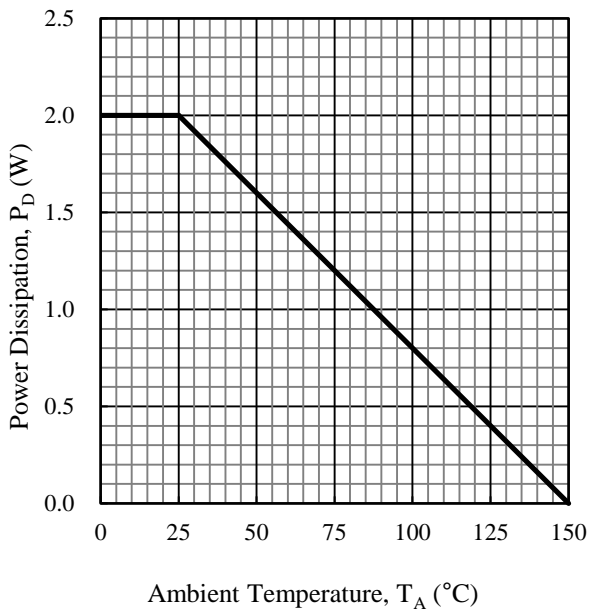

Figure 16. SJPZ-N33 Power Dissipation Curves⁽¹⁰⁾

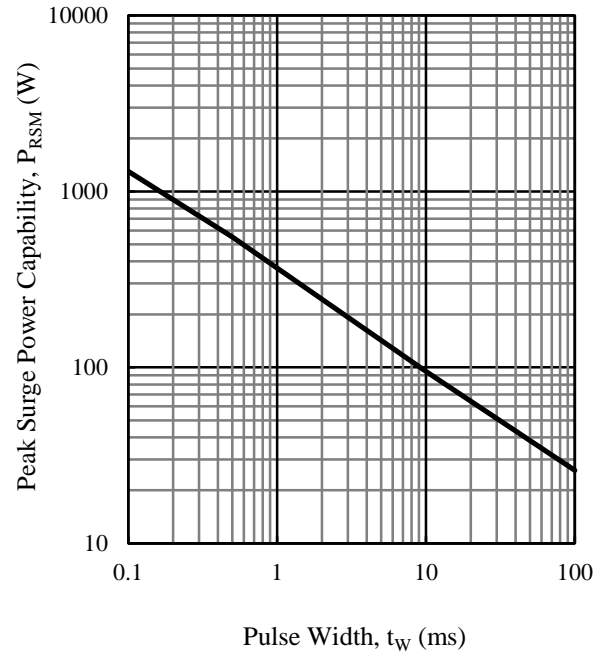

Figure 17. SJPZ-N33 Peak Surge Reverse Power Capability⁽¹¹⁾

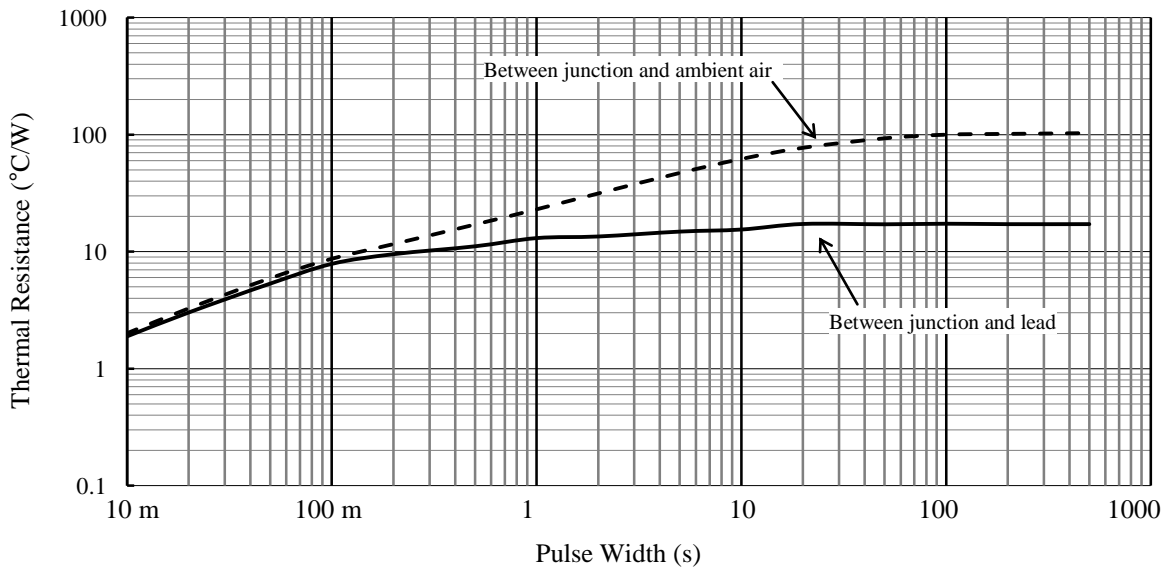

Figure 18. SJPZ-N33 Typical Transient Thermal Resistance⁽¹²⁾

⁽¹⁰⁾ See Figure 1 for the measurement conditions of the lead temperature.

⁽¹¹⁾ t_W is single block pulse..

⁽¹²⁾ See Figure 1 for the measurement conditions of the lead temperature.

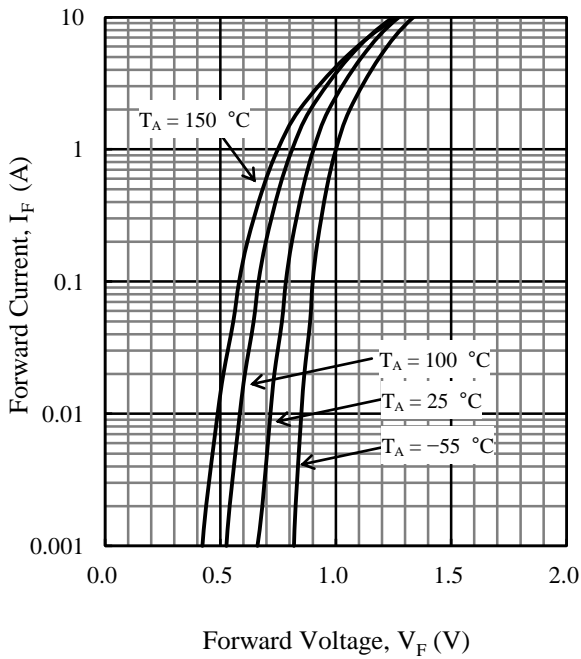

Figure 19. SJPZ-N33 Typical Characteristics: V_F vs. I_F

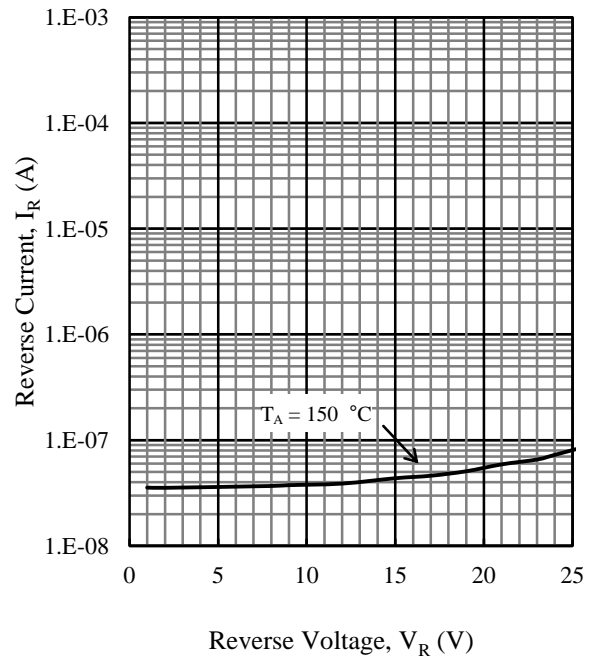

Figure 20. SJPZ-N33 Typical Characteristics: V_R vs. I_R

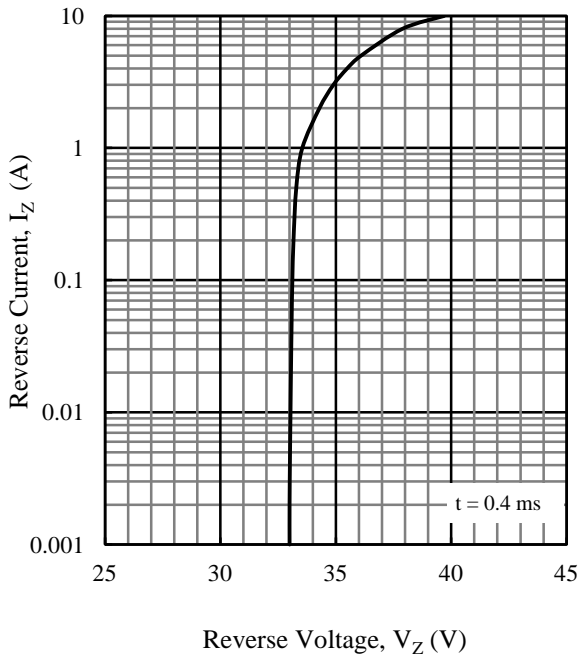

Figure 21. SJPZ-N33 Typical Characteristics: I_Z vs. V_Z

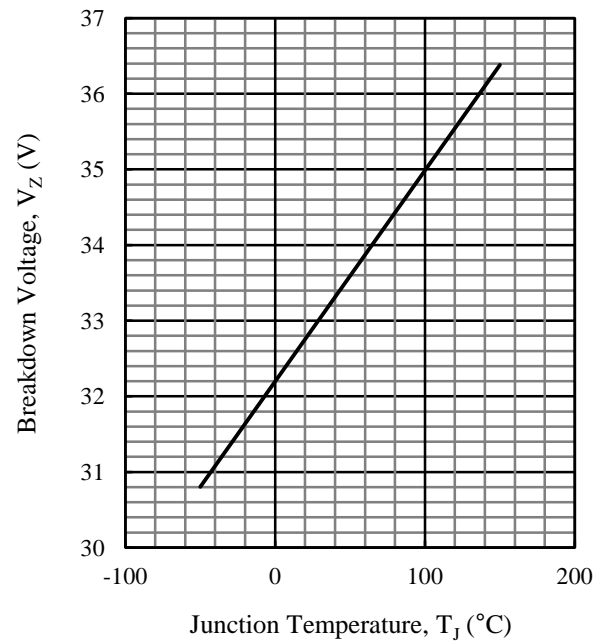

Figure 22. SJPZ-N33 Typical Characteristics: V_Z vs. T_J

SJPZ-N40 Rating and Characteristic Curves

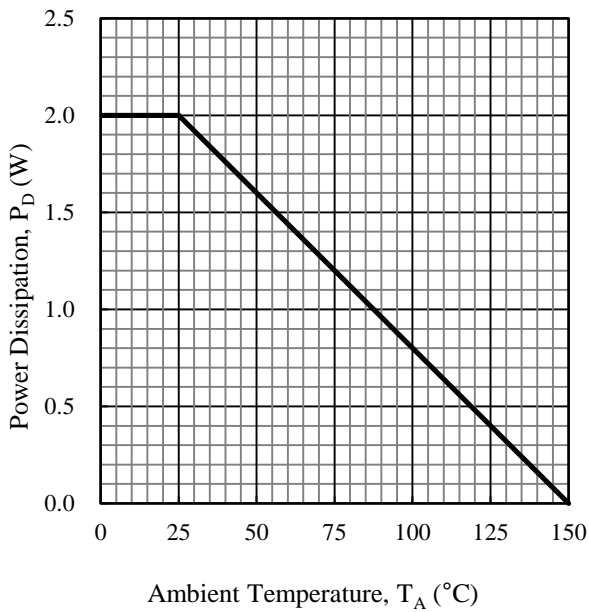

Figure 23. SJPZ-N40 Power Dissipation Curves⁽¹³⁾

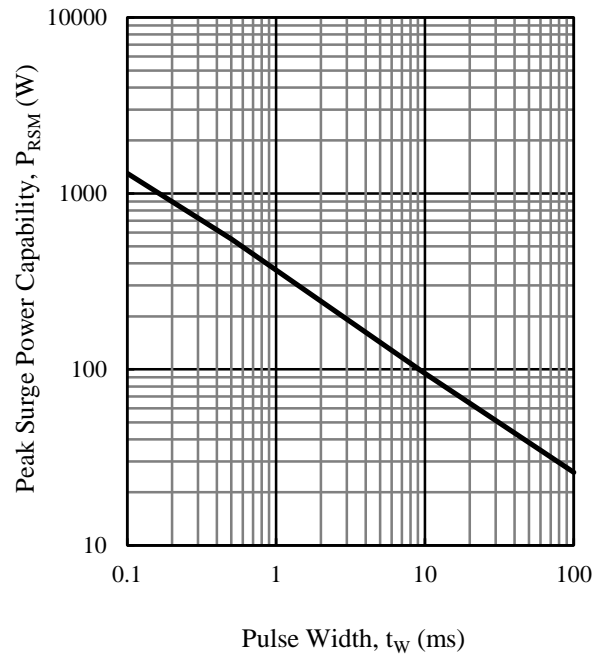

Figure 24. SJPZ-N40 Peak Surge Reverse Power Capability⁽¹⁴⁾

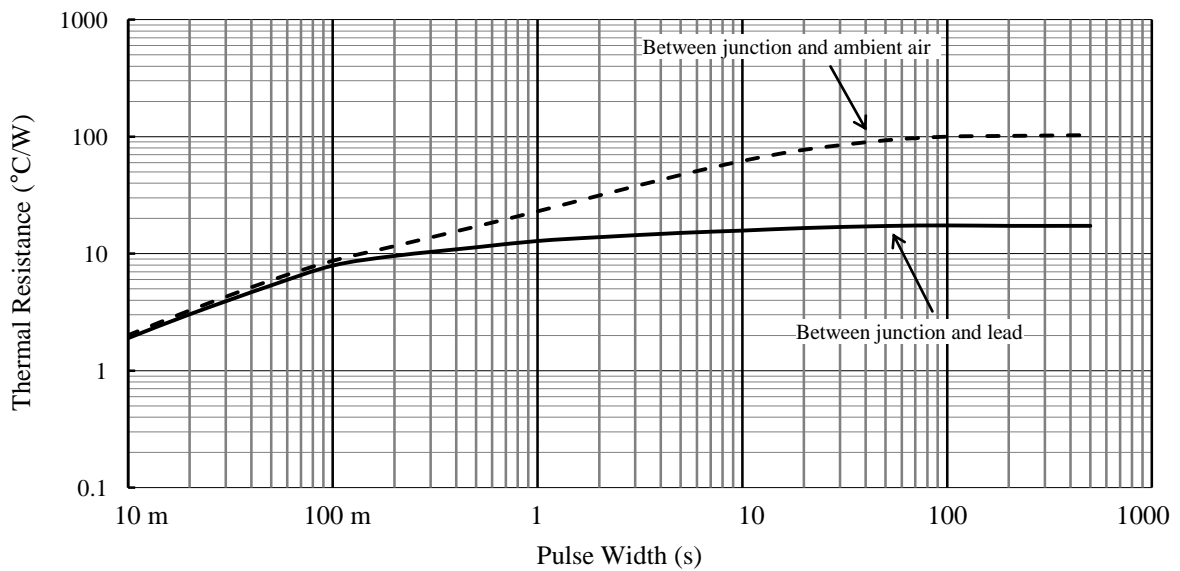

Figure 25. SJPZ-N40 Typical Transient Thermal Resistance⁽¹⁵⁾

⁽¹³⁾ See Figure 1 for the measurement conditions of the lead temperature.

⁽¹⁴⁾ t_W is single block pulse..

⁽¹⁵⁾ See Figure 1 for the measurement conditions of the lead temperature.

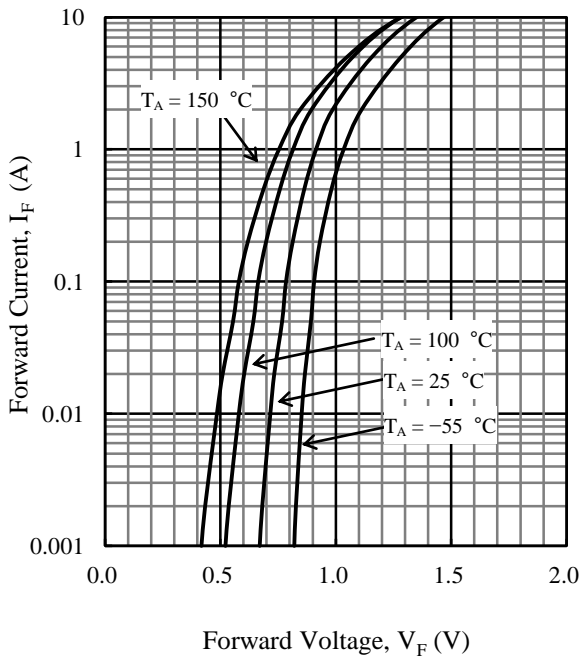

Figure 26. SJPZ-N40 Typical Characteristics: I_F vs. V_F

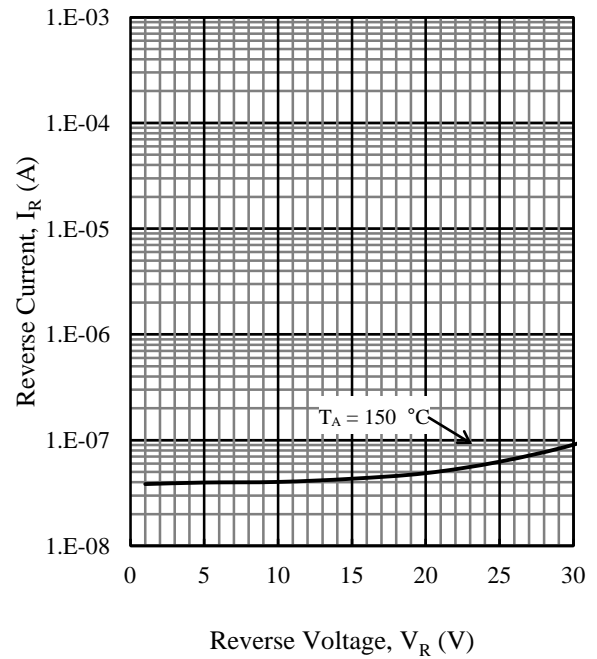

Figure 27. SJPZ-N40 Typical Characteristics: I_R vs. V_R

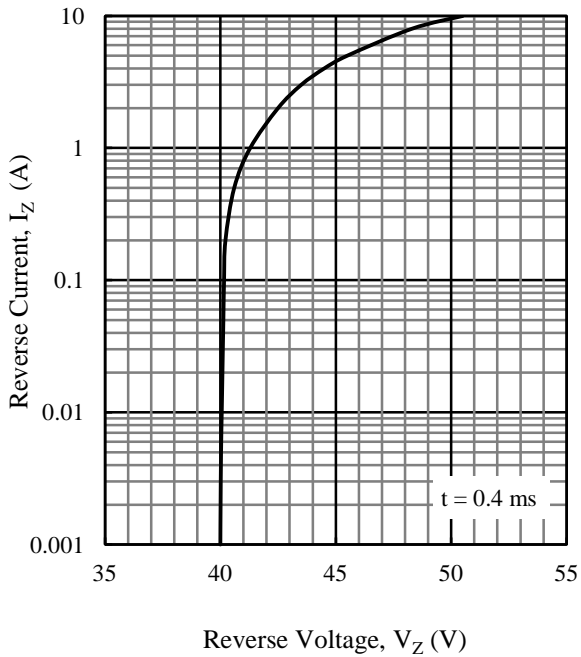

Figure 28. SJPZ-N40 Typical Characteristics: I_Z vs. V_Z

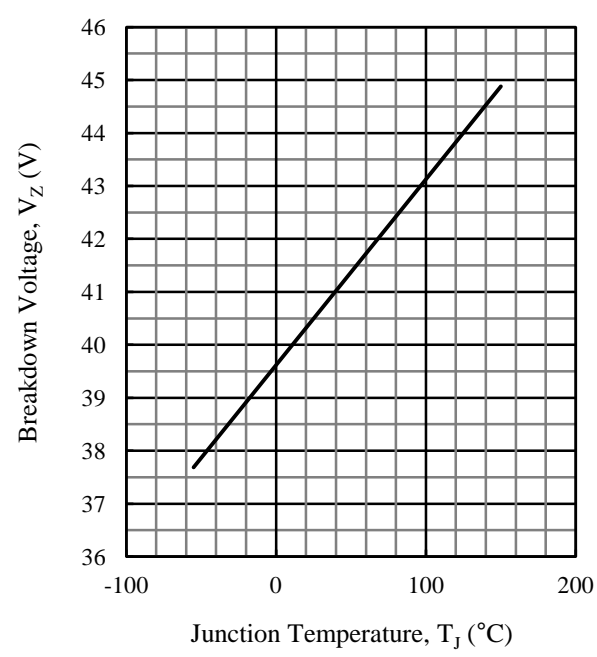
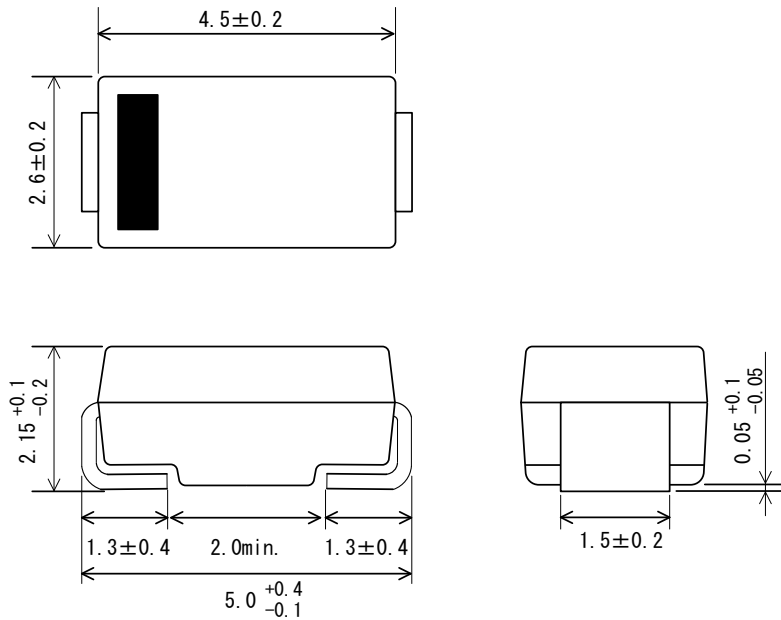

Figure 29. SJPZ-N40 Typical Characteristics: V_Z vs. T_J

SJPZ-N Series

Physical Dimensions

• SJP



NOTES:

- Dimensions in millimeters
- Bare lead frame: Pb-free (RoHS compliant)
- When soldering the products, be sure to minimize the working time, within the following limits:
- MSL: JEDEC LEVEL1
- When soldering the products, it is required to minimize the working time, within the following limits:
 - Flow: 260 ± 5 °C / 10 ± 1 s, 2 times
 - Soldering Iron: 380 ± 10 °C / 3.5 ± 0.5 s, 1 time

• SJP Land Pattern Example

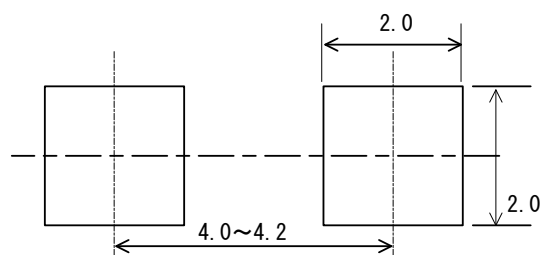

NOTE:

- Dimensions in millimeters

SJPZ-N Series

Marking Diagram

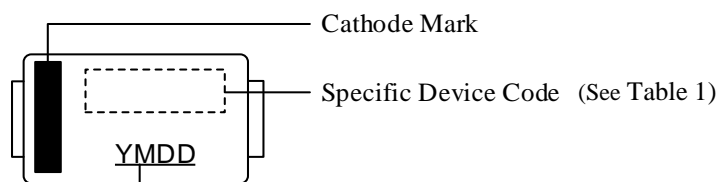

Lot Number:

Y is the last digit of the year of manufacture (0 to 9)

M is the month of the year (1 to 9, O, N or D)

DD is the day of the month (01 to 31)

Table 1. Specific Device Code

Specific Device Code	Part Number
ZN18	SJPZ-N18
ZN27	SJPZ-N27
ZN33	SJPZ-N33
ZN40	SJPZ-N40

Important Notes

- All data, illustrations, graphs, tables and any other information included in this document as to Sanken's products listed herein (the "Sanken Products") are current as of the date this document is issued. All contents in this document are subject to any change without notice due to improvement of the Sanken Products, etc. Please make sure to confirm with a Sanken sales representative that the contents set forth in this document reflect the latest revisions before use.
- The Sanken Products are intended for use as components of electronic equipment or apparatus (transportation equipment and its control systems, home appliances, office equipment, telecommunication equipment, measuring equipment, etc.). Prior to use of the Sanken Products, please put your signature, or affix your name and seal, on the specification documents of the Sanken Products and return them to Sanken. If considering use of the Sanken Products for any applications that require higher reliability (traffic signal control systems or equipment, disaster/crime alarm systems, etc.), you must contact a Sanken sales representative to discuss the suitability of such use and put your signature, or affix your name and seal, on the specification documents of the Sanken Products and return them to Sanken, prior to the use of the Sanken Products. The Sanken Products are not intended for use in any applications that require extremely high reliability such as: aerospace equipment; nuclear power control systems; and medical equipment or systems, whose failure or malfunction may result in death or serious injury to people, i.e., medical devices in Class III or a higher class as defined by relevant laws of Japan (collectively, the "Specific Applications"). Sanken assumes no liability or responsibility whatsoever for any and all damages and losses that may be suffered by you, users or any third party, resulting from the use of the Sanken Products in the Specific Applications or in manner not in compliance with the instructions set forth herein.
- In the event of using the Sanken Products by either (i) combining other products or materials therewith or (ii) physically, chemically or otherwise processing or treating the same, you must duly consider all possible risks that may result from all such uses in advance and proceed therewith at your own responsibility.
- Although Sanken is making efforts to enhance the quality and reliability of its products, it is impossible to completely avoid the occurrence of any failure or defect in semiconductor products at a certain rate. You must take, at your own responsibility, preventative measures including using a sufficient safety design and confirming safety of any equipment or systems in/for which the Sanken Products are used, upon due consideration of a failure occurrence rate or derating, etc., in order not to cause any human injury or death, fire accident or social harm which may result from any failure or malfunction of the Sanken Products. Please refer to the relevant specification documents and Sanken's official website in relation to derating.
- No anti-radioactive ray design has been adopted for the Sanken Products.
- No contents in this document can be transcribed or copied without Sanken's prior written consent.
- The circuit constant, operation examples, circuit examples, pattern layout examples, design examples, recommended examples, all information and evaluation results based thereon, etc., described in this document are presented for the sole purpose of reference of use of the Sanken Products and Sanken assumes no responsibility whatsoever for any and all damages and losses that may be suffered by you, users or any third party, or any possible infringement of any and all property rights including intellectual property rights and any other rights of you, users or any third party, resulting from the foregoing.
- All technical information described in this document (the "Technical Information") is presented for the sole purpose of reference of use of the Sanken Products and no license, express, implied or otherwise, is granted hereby under any intellectual property rights or any other rights of Sanken.
- Unless otherwise agreed in writing between Sanken and you, Sanken makes no warranty of any kind, whether express or implied, including, without limitation, any warranty (i) as to the quality or performance of the Sanken Products (such as implied warranty of merchantability, or implied warranty of fitness for a particular purpose or special environment), (ii) that any Sanken Product is delivered free of claims of third parties by way of infringement or the like, (iii) that may arise from course of performance, course of dealing or usage of trade, and (iv) as to any information contained in this document (including its accuracy, usefulness, or reliability).
- In the event of using the Sanken Products, you must use the same after carefully examining all applicable environmental laws and regulations that regulate the inclusion or use of any particular controlled substances, including, but not limited to, the EU RoHS Directive, so as to be in strict compliance with such applicable laws and regulations.
- You must not use the Sanken Products or the Technical Information for the purpose of any military applications or use, including but not limited to the development of weapons of mass destruction. In the event of exporting the Sanken Products or the Technical Information, or providing them for non-residents, you must comply with all applicable export control laws and regulations in each country including the U.S. Export Administration Regulations (EAR) and the Foreign Exchange and Foreign Trade Act of Japan, and follow the procedures required by such applicable laws and regulations.
- Sanken assumes no responsibility for any troubles, which may occur during the transportation of the Sanken Products including the falling thereof, out of Sanken's distribution network.
- Although Sanken has prepared this document with its due care to pursue the accuracy thereof, Sanken does not warrant that it is error free and Sanken assumes no liability whatsoever for any and all damages and losses which may be suffered by you resulting from any possible errors or omissions in connection with the contents included herein.
- Please refer to the relevant specification documents in relation to particular precautions when using the Sanken Products, and refer to our official website in relation to general instructions and directions for using the Sanken Products.
- All rights and title in and to any specific trademark or tradename belong to Sanken or such original right holder(s).

DSGN-AEZ-16002