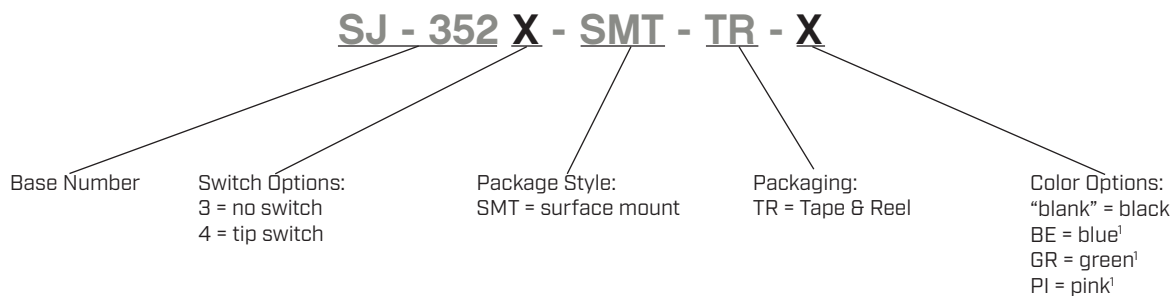

SERIES: SJ-352X-SMT | **DESCRIPTION:** AUDIO JACK**FEATURES**

- low profile design
- switch options include:
 - no switch
 - tip switch

**PART NUMBER KEY**

Note: 1. Tip switch option only

SPECIFICATIONS

| parameter | conditions/description | min | typ | max | units |
|----------------------------|------------------------|-----|-------|-----|--------|
| rated input voltage | | | 12 | | Vdc |
| rated input current | | | | 1 | A |
| contact resistance | | | | 50 | mΩ |
| insulation resistance | at 500 Vdc | 100 | | | MΩ |
| voltage withstand | for 1 minute | | | 500 | Vac |
| insertion/withdrawal force | | 0.3 | | 3 | kg |
| operating temperature | | -25 | | 85 | °C |
| life | | | 5,000 | | cycles |
| flammability rating | UL94V-0 | | | | |
| RoHS | yes | | | | |

MECHANICAL DRAWING

units: mm
 tolerance:
 X. ± 0.5 mm
 X.X ± 0.3 mm
 X.XX ± 0.20 mm
 PCB: ± 0.05 mm

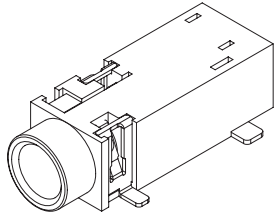

| DESCRIPTION | MATERIAL | PLATING/COLOR |
|-------------|-----------------|---------------------|
| terminal 1 | copper alloy | silver |
| terminal 2 | copper alloy | silver |
| terminal 3 | copper alloy | silver |
| terminal 4 | copper alloy | silver |
| housing | PA10T (UL94V-0) | see part number key |

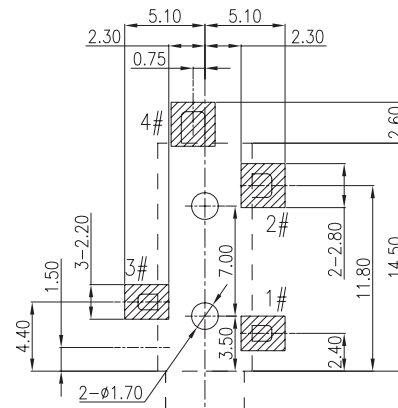
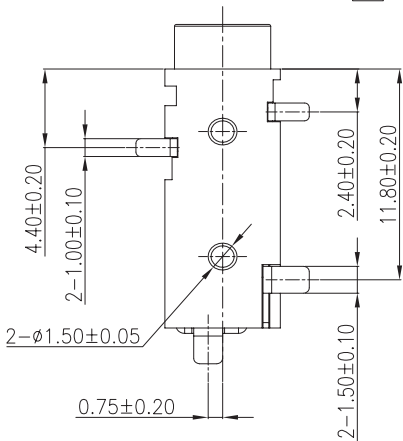
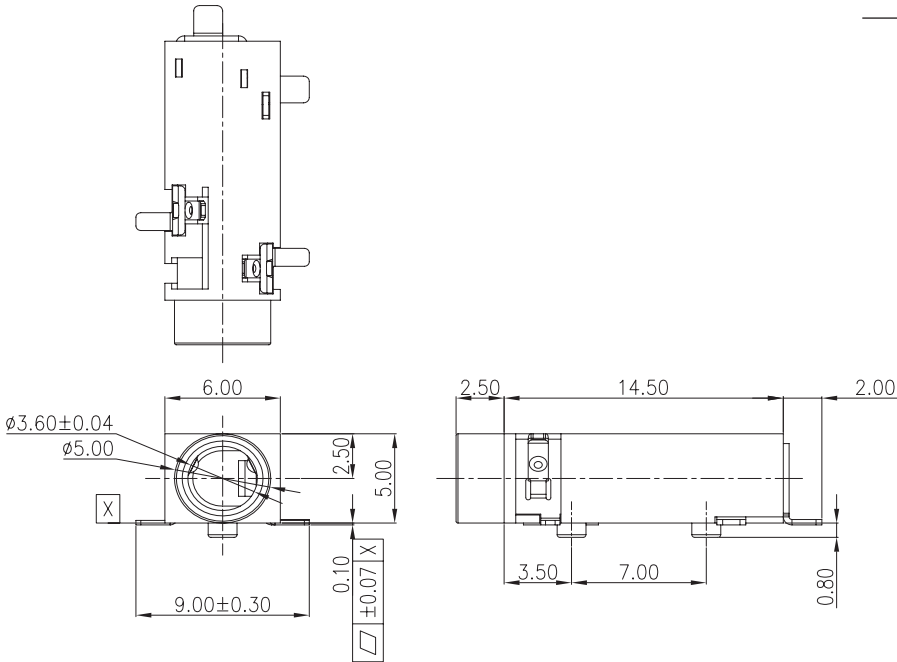

Recommended PCB Layout
Top View

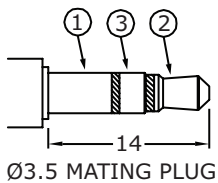

| Model No. | SJ-3523-SMT | SJ-3524-SMT |
|-----------|-------------|-------------|
| Schematic | | |
| PIN | | |
| 1 | sleeve | sleeve |
| 2 | tip | tip |
| 3 | ring | ring |
| 4 | NP | tip switch |

SOLDERABILITY

| parameter | conditions/description | min | typ | max | units |
|------------------|---|-----|-----|-----|-------|
| reel storage | -5~35°C, 25~80% humidity reel opened: use within 1 month reel unopened: use within 6 months | | | | |
| reflow soldering | see reflow profile | | | 260 | °C |

Note: 1. CUI Devices recommends usage of the product within 2 hours after T&R is opened. After 6 hours, CUI Devices recommends drying the parts prior to use.

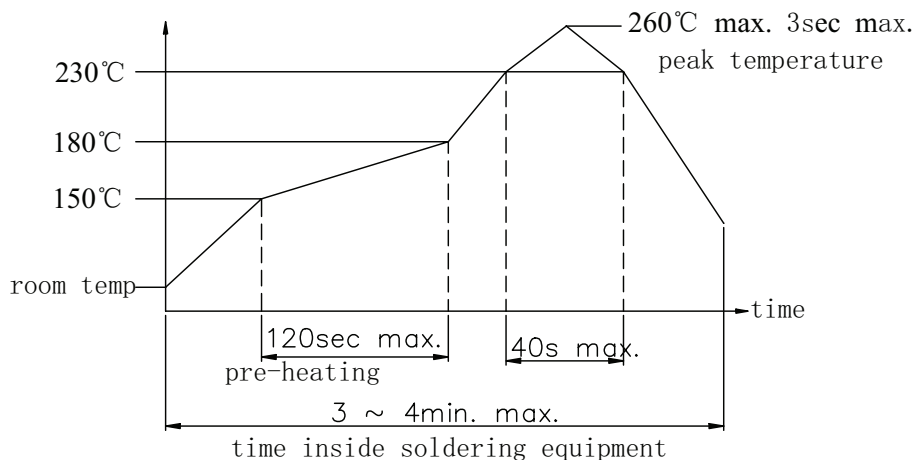

PACKAGING

units: mm

Reel Size: $\varnothing 380$ mm
Reel QTY: 1,000 pcs per reel

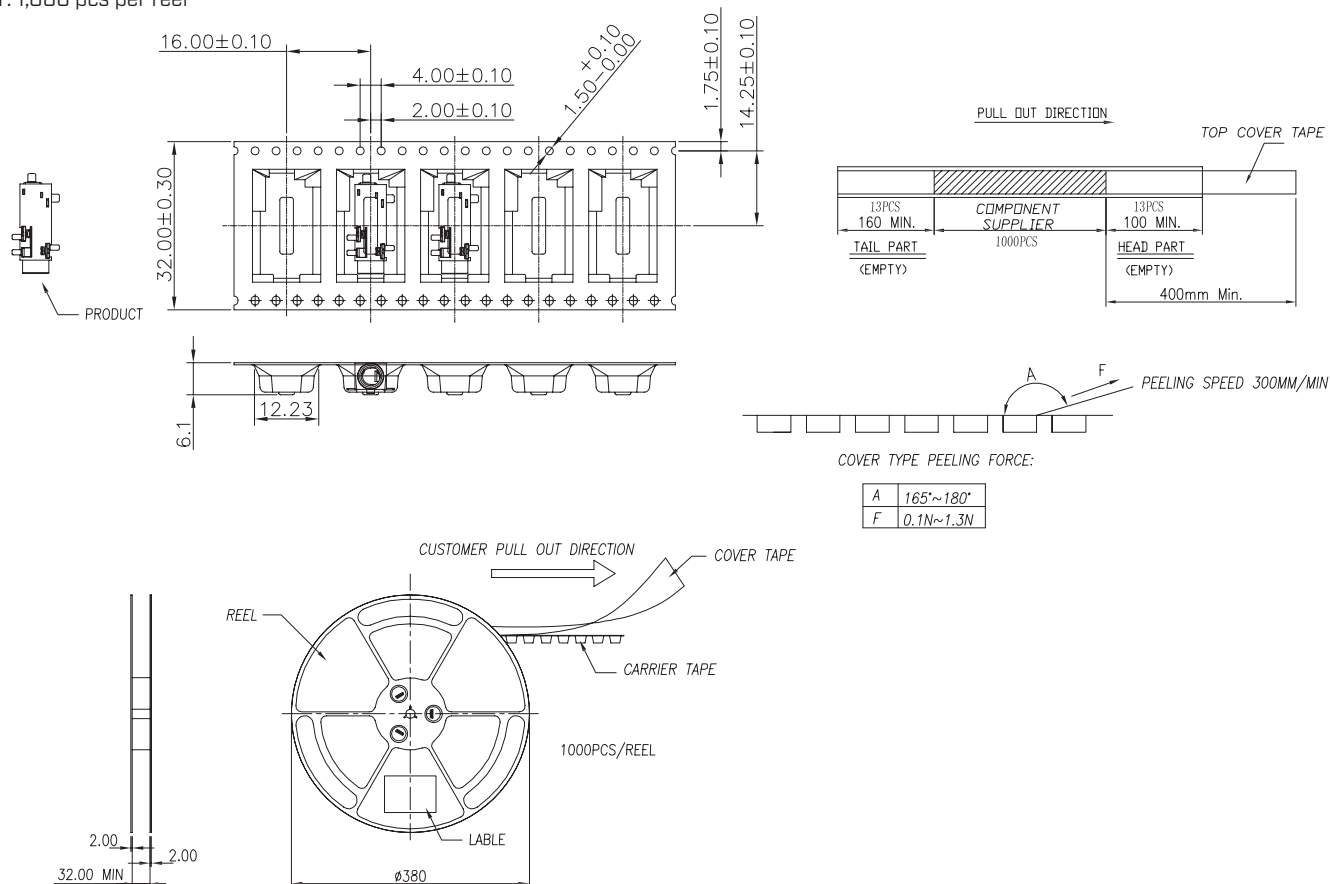

REVISION HISTORY

| rev. | description | date |
|------|--|------------|
| 1.0 | initial release | 02/07/2006 |
| 1.01 | new remplate applied | 01/25/2012 |
| 1.02 | added TR package and color options | 11/01/2012 |
| 1.03 | added storage and drying conditions, and tape and reel packaging details | 02/15/2018 |
| 1.04 | brand update | 10/09/2019 |
| 1.05 | updated datasheet | 08/24/2022 |

The revision history provided is for informational purposes only and is believed to be accurate.



CUI Devices offers a one (1) year limited warranty. Complete warranty information is listed on our website.

CUI Devices reserves the right to make changes to the product at any time without notice. Information provided by CUI Devices is believed to be accurate and reliable. However, no responsibility is assumed by CUI Devices for its use, nor for any infringements of patents or other rights of third parties which may result from its use.

CUI Devices products are not authorized or warranted for use as critical components in equipment that requires an extremely high level of reliability. A critical component is any component of a life support device or system whose failure to perform can be reasonably expected to cause the failure of the life support device or system, or to affect its safety or effectiveness.

cuidevices.com