

N-Channel 80 V (D-S) 175 °C MOSFET

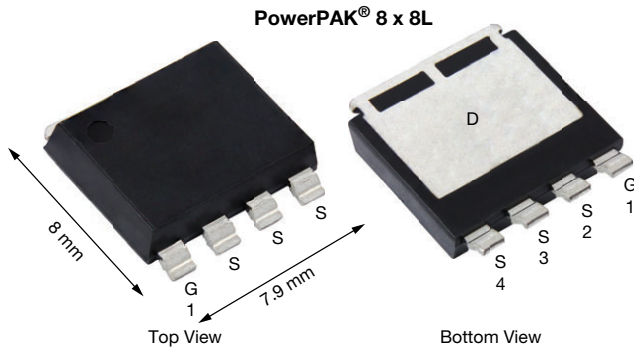

FEATURES

- TrenchFET® Gen V power MOSFET
- Fully lead (Pb)-free device
- Very low R_{DS} x Q_g figure of merit (FOM)
- Up to 302 A maximum continuous drain current
- 50 % smaller footprint than D²PAK (TO-263)
- 100 % R_g and UIS tested
- Material categorization: for definitions of compliance please see www.vishay.com/doc?99912



RoHS
COMPLIANT
HALOGEN
FREE

APPLICATIONS

- Synchronous rectification
- OR-ing
- Motor drive control
- Battery management

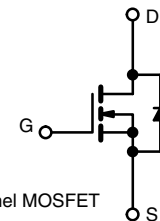

N-Channel MOSFET

PRODUCT SUMMARY	
V_{DS} (V)	80
$R_{DS(on)}$ max. (Ω) at $V_{GS} = 10$ V	0.00135
$R_{DS(on)}$ max. (Ω) at $V_{GS} = 7.5$ V	0.00158
Q_g typ. (nC)	103
I_D (A) ^a	302
Configuration	Single

ORDERING INFORMATION	
Package	PowerPAK 8 x 8L
Lead (Pb)-free and halogen-free	SIJH5800E-T1-GE3

ABSOLUTE MAXIMUM RATINGS ($T_A = 25$ °C, unless otherwise noted)				
PARAMETER	SYMBOL	LIMIT	UNIT	
Drain-source voltage	V_{DS}	80	V	
Gate-source voltage	V_{GS}	± 20	V	
Continuous drain current ($T_J = 175$ °C)	I_D	$T_C = 25$ °C	302	A
		$T_C = 70$ °C	253	
		$T_A = 25$ °C	30 ^b	
		$T_A = 70$ °C	25 ^b	
Pulsed drain current ($t = 100$ μ s)	I_{DM}	500	A	
Continuous source-drain diode current	I_S	$T_C = 25$ °C	303	A
		$T_A = 25$ °C	3 ^b	
Single pulse avalanche current	I_{AS}	75	A	
Single pulse avalanche energy	E_{AS}	281	mJ	
Maximum power dissipation	P_D	$T_C = 25$ °C	333	W
		$T_C = 70$ °C	233	
		$T_A = 25$ °C	3.3 ^b	
		$T_A = 70$ °C	2.3 ^b	
Operating junction and storage temperature range	T_J, T_{stg}	-55 to +175	°C	
Soldering recommendations (peak temperature) ^c		260	°C	

THERMAL RESISTANCE RATINGS				
PARAMETER	SYMBOL	TYPICAL	MAXIMUM	UNIT
Maximum junction-to-ambient ^b	R_{thJA}	36	45	°C/W
Maximum junction-to-case (drain)				

Notes

- $T_C = 25$ °C
- Surface mounted on 1" x 1" FR4 board
- See solder profile (www.vishay.com/doc?73257). The PowerPAK 8 x 8L is a leadless package. The end of the lead terminal is exposed copper (not plated) as a result of the singulation process in manufacturing. A solder fillet at the exposed copper tip cannot be guaranteed and is not required to ensure adequate bottom side solder interconnection
- Rework conditions: manual soldering with a soldering iron is not recommended for leadless components



SPECIFICATIONS (T _J = 25 °C, unless otherwise noted)						
PARAMETER	SYMBOL	TEST CONDITIONS	MIN.	TYP.	MAX.	UNIT
Static						
Drain-source breakdown voltage	V _{DS}	V _{GS} = 0 V, I _D = 1 mA	80	-	-	V
V _{DS} temperature coefficient	ΔV _{DS} /T _J	I _D = 10 mA	-	36	-	mV/°C
V _{GS(th)} temperature coefficient	ΔV _{GS(th)} /T _J	I _D = 250 μA	-	-9.7	-	
Gate-source threshold voltage	V _{GS(th)}	V _{DS} = V _{GS} , I _D = 250 μA	2	-	4	V
Gate-source leakage	I _{GSS}	V _{DS} = 0 V, V _{GS} = ±20	-	-	100	nA
Zero gate voltage drain current	I _{DSS}	V _{DS} = 64 V, V _{GS} = 0 V	-	-	1	μA
		V _{DS} = 64 V, V _{GS} = 0 V, T _J = 70 °C	-	-	15	
Drain-source on-state resistance ^a	R _{DS(on)}	V _{GS} = 10 V, I _D = 20 A	-	0.00097	0.00135	Ω
		V _{GS} = 7.5 V, I _D = 20 A	-	0.0012	0.00158	
Forward transconductance ^a	g _{fs}	V _{DS} = 15 V, I _D = 75 A	-	170	-	S
Dynamic ^b						
Input capacitance	C _{iss}	V _{DS} = 40 V, V _{GS} = 0 V, f = 1 MHz	-	7730	-	pF
Output capacitance	C _{oss}		-	2442	-	
Reverse transfer capacitance	C _{rss}		-	20	-	
Total gate charge	Q _g	V _{DS} = 40 V, V _{GS} = 10 V, I _D = 20 A	-	103	155	nC
		V _{DS} = 40 V, V _{GS} = 7.5 V, I _D = 20 A	-	78	120	
Gate-source charge	Q _{gs}		-	35	-	
Gate-drain charge	Q _{gd}		-	11	-	
Gate resistance	R _g	f = 1 MHz	0.34	1.7	3.4	Ω
Turn-on delay time	t _{d(on)}	V _{DD} = 40 V, R _L = 4 Ω, I _D ≅ 10 A, V _{GEN} = 10 V, R _g = 1 Ω	-	20	40	ns
Rise time	t _r		-	16	35	
Turn-off delay time	t _{d(off)}		-	53	100	
Fall time	t _f		-	27	60	
Turn-on delay time	t _{d(on)}	V _{DD} = 40 V, R _L = 4 Ω, I _D ≅ 10 A, V _{GEN} = 7.5 V, R _g = 1 Ω	-	25	50	
Rise time	t _r		-	28	60	
Turn-off delay time	t _{d(off)}		-	48	100	
Fall time	t _f		-	27	60	
Drain-Source Body Diode Characteristics						
Continuous source-drain diode current	I _S	T _C = 25 °C	-	-	303	A
Pulse diode forward current	I _{SM}		-	-	500	
Body diode voltage	V _{SD}	I _S = 10 A, V _{GS} = 0 V	-	0.72	1.1	V
Body diode reverse recovery time	t _{rr}	I _F = 10 A, di/dt = 100 A/μs, T _J = 25 °C	-	106	210	ns
Body diode reverse recovery charge	Q _{rr}		-	190	380	nC
Reverse recovery fall time	t _a		-	55	-	ns
Reverse recovery rise time	t _b		-	51	-	

Notes

- a. Pulse test; pulse width ≤ 300 μs, duty cycle ≤ 2 %.
- b. Guaranteed by design, not subject to production testing.

Stresses beyond those listed under "Absolute Maximum Ratings" may cause permanent damage to the device. These are stress ratings only, and functional operation of the device at these or any other conditions beyond those indicated in the operational sections of the specifications is not implied. Exposure to absolute maximum rating conditions for extended periods may affect device reliability.



TYPICAL CHARACTERISTICS (25 °C, unless otherwise noted)

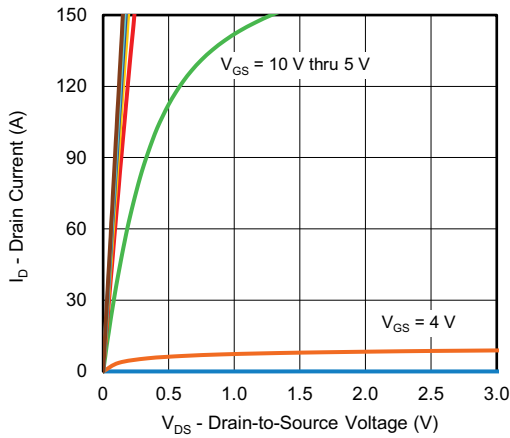

Output Characteristics

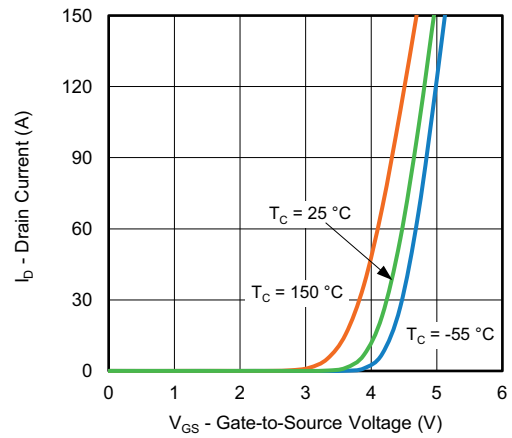

Transfer Characteristics

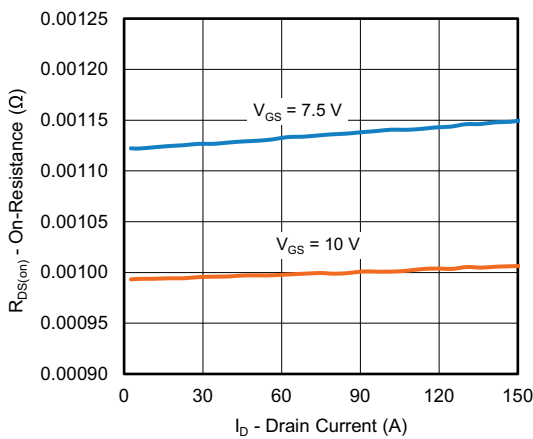

On-Resistance vs. Drain Current and Gate Voltage

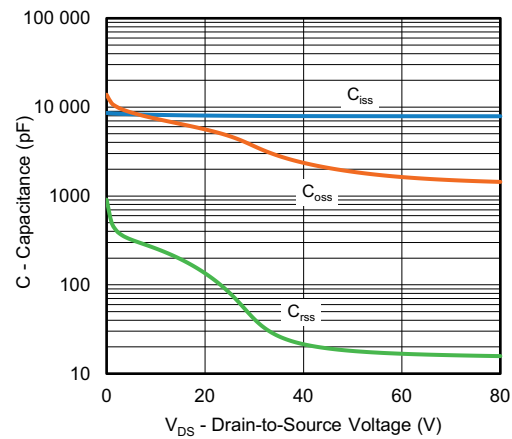

Capacitance

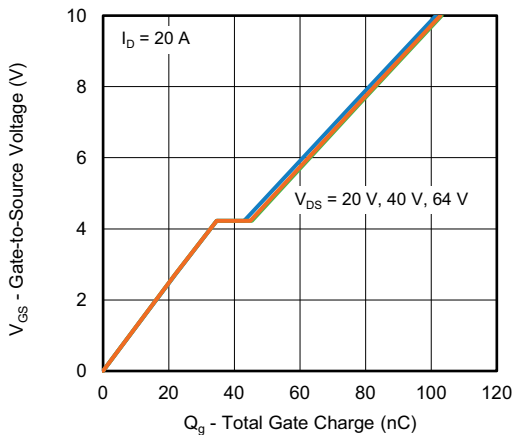

Gate Charge

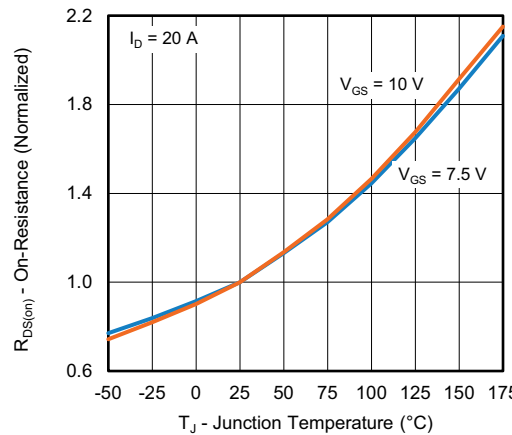

On-Resistance vs. Junction Temperature



TYPICAL CHARACTERISTICS (25 °C, unless otherwise noted)

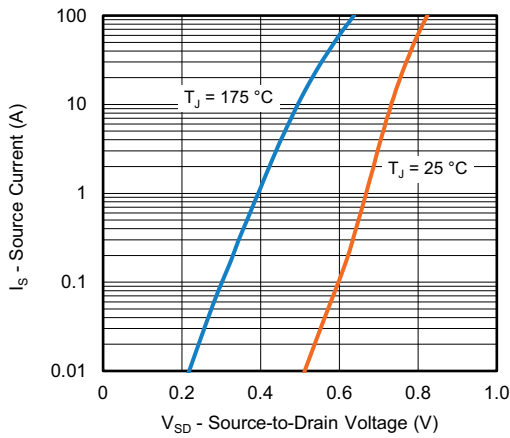

Source-Drain Diode Forward Voltage

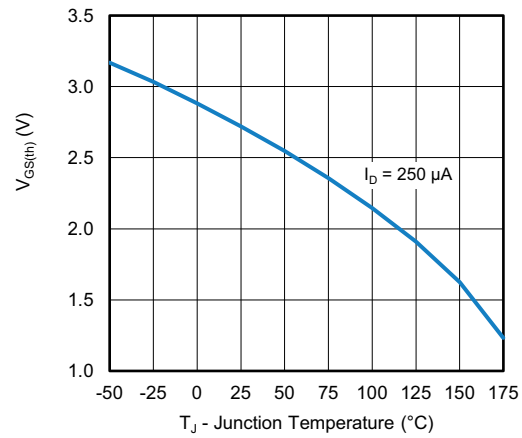

Threshold Voltage

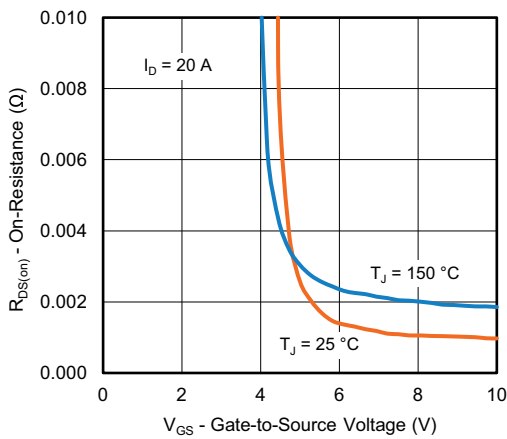

On-Resistance vs. Gate-to-Source Voltage

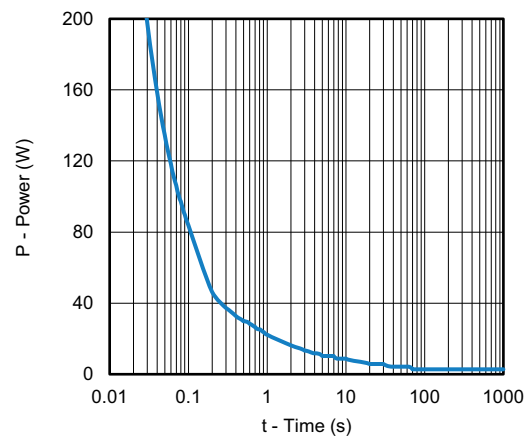

Single Pulse Power, Junction-to-Ambient

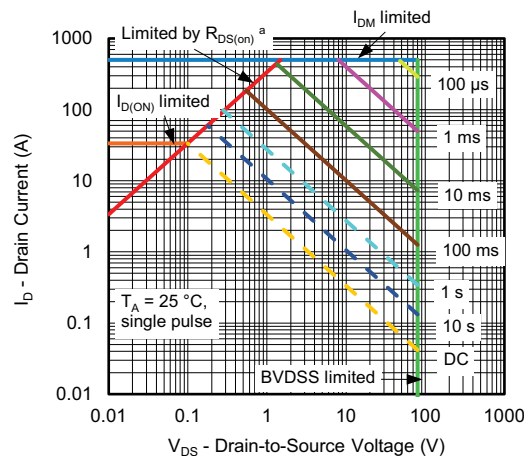

Safe Operating Area, Junction-to-Ambient

Note

a. $V_{GS} >$ minimum V_{GS} at which $R_{DS(on)}$ is specified



TYPICAL CHARACTERISTICS (25 °C, unless otherwise noted)

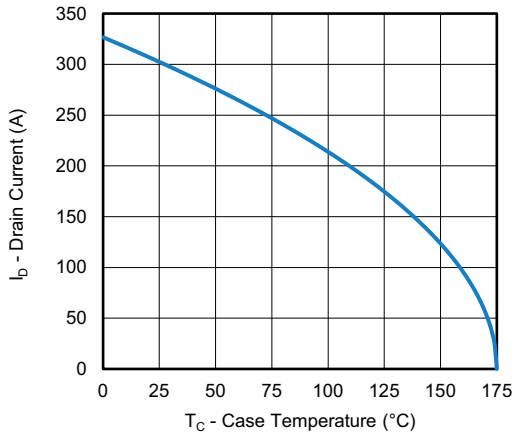

Current Derating ^a

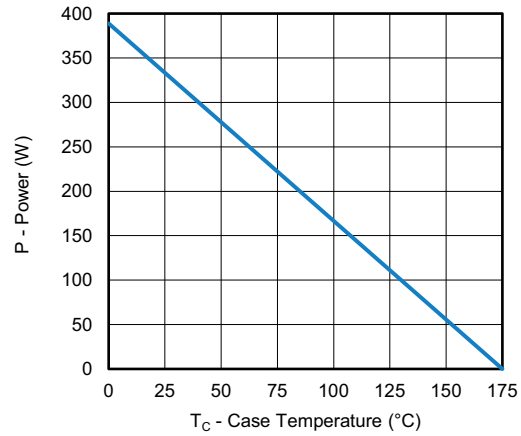

Power, Junction-to-Case

Note

- a. The power dissipation P_D is based on T_J max. = 150 °C, using junction-to-case thermal resistance, and is more useful in settling the upper dissipation limit for cases where additional heatsinking is used. It is used to determine the current rating, when this rating falls below the package limit



TYPICAL CHARACTERISTICS (25 °C, unless otherwise noted)

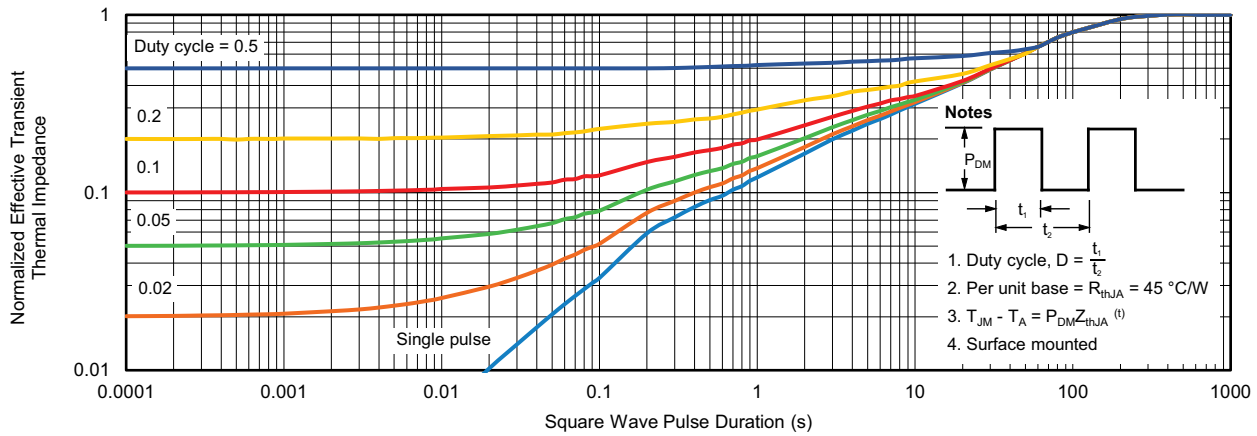

Normalized Thermal Transient Impedance, Junction-to-Ambient

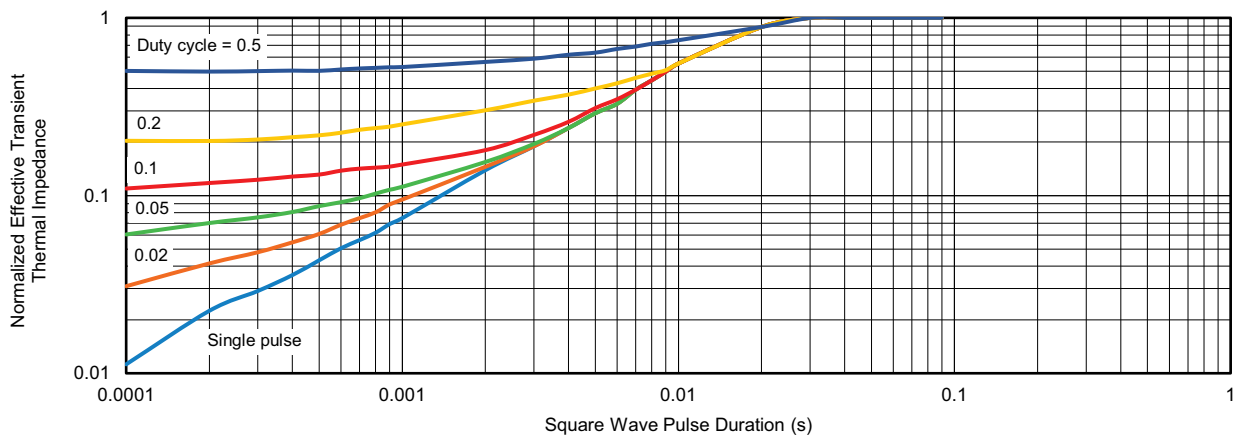

Normalized Thermal Transient Impedance, Junction-to-Case

Vishay Siliconix maintains worldwide manufacturing capability. Products may be manufactured at one of several qualified locations. Reliability data for Silicon Technology and Package Reliability represent a composite of all qualified locations. For related documents such as package/tape drawings, part marking, and reliability data, see www.vishay.com/ppg?62057.

PowerPAK[®] 8 x 8L BWL Case Outline 2

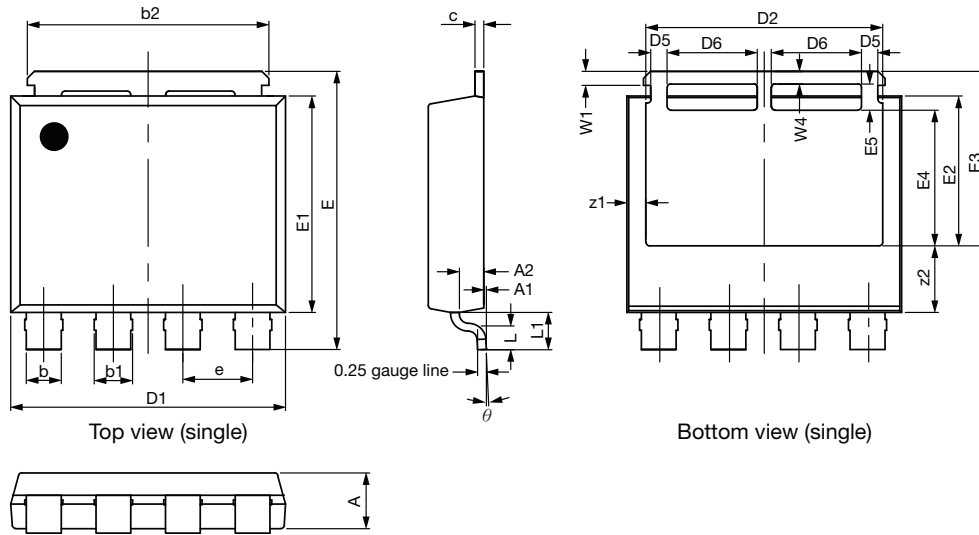

DIM.	MILLIMETERS			INCHES		
	MIN.	NOM.	MAX.	MIN.	NOM.	MAX.
A	1.50	1.60	1.70	0.059	0.063	0.067
A1	0.00	-	0.127	0.000	-	0.005
A2	0.655	0.705	0.755	0.026	0.028	0.030
b	0.92	1.00	1.08	0.036	0.039	0.043
b1	1.02	1.10	1.18	0.040	0.043	0.046
b2	6.84	6.94	7.04	0.269	0.273	0.277
c	0.20	0.25	0.30	0.008	0.010	0.012
D1	7.80	7.90	8.00	0.307	0.311	0.315
D2	6.70	6.80	6.90	0.264	0.268	0.272
D5	0.37	0.47	0.57	0.015	0.019	0.022
D6	2.49	2.59	2.69	0.098	0.102	0.106
e	1.97	2.00	2.03	0.078	0.079	0.080
E	7.90	8.00	8.10	0.311	0.315	0.319
E1	6.12	6.22	6.32	0.241	0.245	0.249
E2	4.21	4.31	4.41	0.166	0.170	0.174
E3	4.92	5.02	5.12	0.194	0.198	0.202
E4	3.80	3.90	4.00	0.150	0.154	0.157
E5	0.65	0.75	0.85	0.026	0.030	0.033
L	0.61	0.68	0.75	0.024	0.027	0.030
L1	1.00	1.07	1.15	0.039	0.042	0.045
W1	0.30	0.40	0.50	0.012	0.016	0.020
W4	0.32	0.37	0.42	0.013	0.015	0.017
z1	0.45	0.55	0.65	0.018	0.022	0.026
z2	1.81	1.91	2.01	0.071	0.075	0.079
θ	0°	-	5°	0°	-	5°

ECN: S19-0643-Rev. B, 05-Aug-2019
DWG: 6073

Note

- Millimeter will govern



Disclaimer

ALL PRODUCT, PRODUCT SPECIFICATIONS AND DATA ARE SUBJECT TO CHANGE WITHOUT NOTICE TO IMPROVE RELIABILITY, FUNCTION OR DESIGN OR OTHERWISE.

Vishay Intertechnology, Inc., its affiliates, agents, and employees, and all persons acting on its or their behalf (collectively, "Vishay"), disclaim any and all liability for any errors, inaccuracies or incompleteness contained in any datasheet or in any other disclosure relating to any product.

Vishay makes no warranty, representation or guarantee regarding the suitability of the products for any particular purpose or the continuing production of any product. To the maximum extent permitted by applicable law, Vishay disclaims (i) any and all liability arising out of the application or use of any product, (ii) any and all liability, including without limitation special, consequential or incidental damages, and (iii) any and all implied warranties, including warranties of fitness for particular purpose, non-infringement and merchantability.

Statements regarding the suitability of products for certain types of applications are based on Vishay's knowledge of typical requirements that are often placed on Vishay products in generic applications. Such statements are not binding statements about the suitability of products for a particular application. It is the customer's responsibility to validate that a particular product with the properties described in the product specification is suitable for use in a particular application. Parameters provided in datasheets and / or specifications may vary in different applications and performance may vary over time. All operating parameters, including typical parameters, must be validated for each customer application by the customer's technical experts. Product specifications do not expand or otherwise modify Vishay's terms and conditions of purchase, including but not limited to the warranty expressed therein.

Hyperlinks included in this datasheet may direct users to third-party websites. These links are provided as a convenience and for informational purposes only. Inclusion of these hyperlinks does not constitute an endorsement or an approval by Vishay of any of the products, services or opinions of the corporation, organization or individual associated with the third-party website. Vishay disclaims any and all liability and bears no responsibility for the accuracy, legality or content of the third-party website or for that of subsequent links.

Except as expressly indicated in writing, Vishay products are not designed for use in medical, life-saving, or life-sustaining applications or for any other application in which the failure of the Vishay product could result in personal injury or death. Customers using or selling Vishay products not expressly indicated for use in such applications do so at their own risk. Please contact authorized Vishay personnel to obtain written terms and conditions regarding products designed for such applications.

No license, express or implied, by estoppel or otherwise, to any intellectual property rights is granted by this document or by any conduct of Vishay. Product names and markings noted herein may be trademarks of their respective owners.