

D Series Power MOSFET

TO-220 FULLPAK

FEATURES

- Optimal design
 - Low area specific on-resistance
 - Low input capacitance (C_{iss})
 - Reduced capacitive switching losses
 - High body diode ruggedness
 - Avalanche energy rated (UIS)
- Optimal efficiency and operation
 - Low cost
 - Simple gate drive circuitry
 - Low figure-of-merit (FOM): $R_{on} \times Q_g$
 - Fast switching
- Material categorization: for definitions of compliance please see www.vishay.com/doc?99912

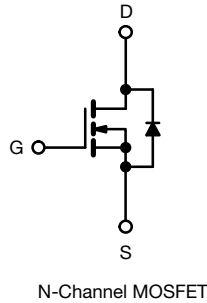

Note

* This datasheet provides information about parts that are RoHS-compliant and / or parts that are non-RoHS-compliant. For example, parts with lead (Pb) terminations are not RoHS-compliant. Please see the information / tables in this datasheet for details.

APPLICATIONS

- Consumer electronics
 - Displays (LCD or plasma TV)
- Server and telecom power supplies
 - SMPS
- Industrial
 - Welding
 - Induction heating
 - Motor drives
- Battery chargers

PRODUCT SUMMARY	
V_{DS} (V) at T_J max.	450
$R_{DS(on)}$ max. (Ω) at 25 °C	$V_{GS} = 10$ V 1.0
Q_g max. (nC)	18
Q_{gs} (nC)	3
Q_{gd} (nC)	4
Configuration	Single

ORDERING INFORMATION	
Package	TO-220 FULLPAK
Lead (Pb)-free	SiHF6N40D-E3

ABSOLUTE MAXIMUM RATINGS ($T_C = 25$ °C, unless otherwise noted)				
PARAMETER	SYMBOL	LIMIT	UNIT	
Drain-Source Voltage	V_{DS}	400	V	
Gate-Source Voltage	V_{GS}	± 30		
Gate-Source Voltage AC ($f > 1$ Hz)		30		
Continuous Drain Current ($T_J = 150$ °C) ^e	V_{GS} at 10 V	$T_C = 25$ °C	6	A
		$T_C = 100$ °C	4	
Pulsed Drain Current ^a	I_{DM}	13		
Linear Derating Factor		0.24	W/°C	
Single Pulse Avalanche Energy ^b	E_{AS}	104	mJ	
Maximum Power Dissipation	P_D	30	W	
Operating Junction and Storage Temperature Range	T_J, T_{stg}	-55 to +150	°C	
Drain-Source Voltage Slope	dV/dt	$T_J = 125$ °C	24	V/ns
Reverse Diode dV/dt ^d		0.48		
Soldering Recommendations (Peak temperature) ^c	For 10 s	300	°C	
Mounting Torque	M3 screw	0.6	Nm	

Notes

- Repetitive rating; pulse width limited by maximum junction temperature.
- $V_{DD} = 50$ V, starting $T_J = 25$ °C, $L = 2.3$ mH, $R_g = 25$ Ω , $I_{AS} = 9.5$ A.
- 1.6 mm from case.
- $I_{SD} \leq I_D$, starting $T_J = 25$ °C.
- Limited by maximum junction temperature.



THERMAL RESISTANCE RATINGS				
PARAMETER	SYMBOL	TYP.	MAX.	UNIT
Maximum Junction-to-Ambient	R _{thJA}	-	65	°C/W
Maximum Junction-to-Case (Drain)	R _{thJC}	-	4.1	

SPECIFICATIONS (T _J = 25 °C, unless otherwise noted)							
PARAMETER	SYMBOL	TEST CONDITIONS		MIN.	TYP.	MAX.	UNIT
Static							
Drain-Source Breakdown Voltage	V _{DS}	V _{GS} = 0 V, I _D = 250 μA		400	-	-	V
V _{DS} Temperature Coefficient	ΔV _{DS} /T _J	Reference to 25 °C, I _D = 250 μA		-	0.53	-	V/°C
Gate-Source Threshold Voltage (N)	V _{GS(th)}	V _{DS} = V _{GS} , I _D = 250 μA		3	-	5	V
Gate-Source Leakage	I _{GSS}	V _{GS} = ± 30 V		-	-	± 100	nA
Zero Gate Voltage Drain Current	I _{DSS}	V _{DS} = 400 V, V _{GS} = 0 V		-	-	1	μA
		V _{DS} = 320 V, V _{GS} = 0 V, T _J = 125 °C		-	-	10	
Drain-Source On-State Resistance	R _{DS(on)}	V _{GS} = 10 V	I _D = 3 A	-	0.85	1.0	Ω
Forward Transconductance	g _{fs}	V _{DS} = 50 V, I _D = 3 A		-	1.7	-	S
Dynamic							
Input Capacitance	C _{iss}	V _{GS} = 0 V, V _{DS} = 100 V, f = 1 MHz		-	311	-	pF
Output Capacitance	C _{oss}			-	38	-	
Reverse Transfer Capacitance	C _{rss}			-	7	-	
Effective output capacitance, energy related ^a	C _{o(er)}			-	44	-	
Effective output capacitance, time related ^b	C _{o(tr)}	V _{GS} = 0 V, V _{DS} = 0 V to 320 V		-	54	-	
Total Gate Charge	Q _g	V _{GS} = 10 V	I _D = 3 A, V _{DS} = 320 V	-	9	18	nC
Gate-Source Charge	Q _{gs}			-	3	-	
Gate-Drain Charge	Q _{gd}			-	4	-	
Turn-On Delay Time	t _{d(on)}	V _{DD} = 400 V, I _D = 3 A, V _{GS} = 10 V, R _g = 9.1 Ω		-	12	24	ns
Rise Time	t _r			-	11	22	
Turn-Off Delay Time	t _{d(off)}			-	14	28	
Fall Time	t _f			-	8	16	
Gate Input Resistance	R _g	f = 1 MHz, open drain		-	1.9	-	Ω
Drain-Source Body Diode Characteristics							
Continuous Source-Drain Diode Current	I _S	MOSFET symbol showing the integral reverse p - n junction diode 		-	-	6	A
Pulsed Diode Forward Current	I _{SM}			-	-	24	
Diode Forward Voltage	V _{SD}	T _J = 25 °C, I _S = 3 A, V _{GS} = 0 V		-	-	1.2	V
Reverse Recovery Time	t _{rr}	T _J = 25 °C, I _F = I _S = 3 A, di/dt = 100 A/μs, V _R = 20 V		-	236	-	ns
Reverse Recovery Charge	Q _{rr}			-	1.1	-	μC
Reverse Recovery Current	I _{RRM}			-	9	-	A

Notes

- a. C_{oss(er)} is a fixed capacitance that gives the same energy as C_{oss} while V_{DS} is rising from 0 % to 80 % V_{DS}.
- b. C_{oss(tr)} is a fixed capacitance that gives the same charging time as C_{oss} while V_{DS} is rising from 0 % to 80 % V_{DS}.

TYPICAL CHARACTERISTICS (25 °C, unless otherwise noted)

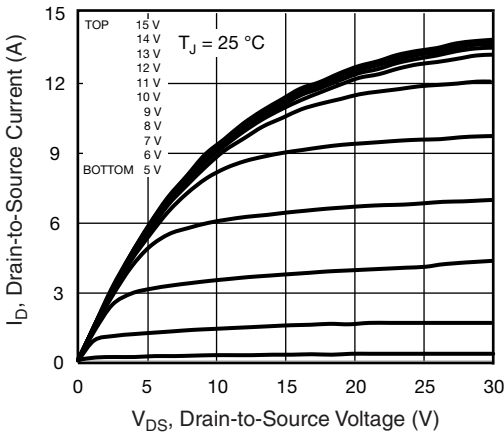

Fig. 1 - Typical Output Characteristics

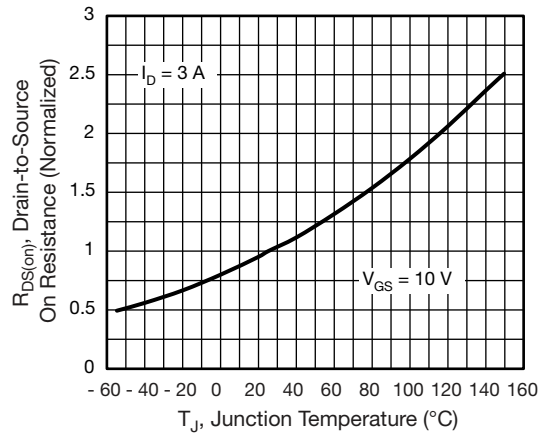

Fig. 4 - Normalized On-Resistance vs. Temperature

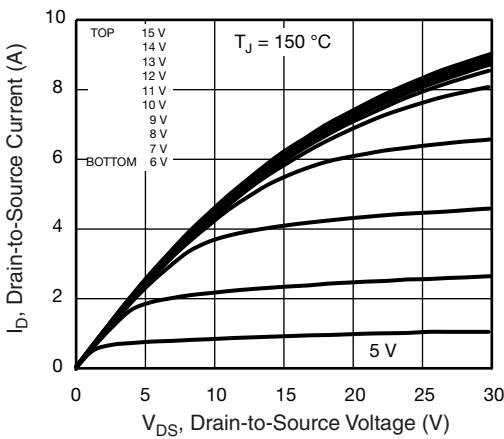

Fig. 2 - Typical Output Characteristics

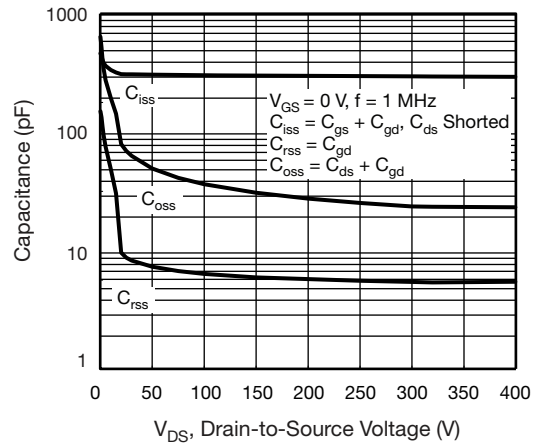

Fig. 5 - Typical Capacitance vs. Drain-to-Source Voltage

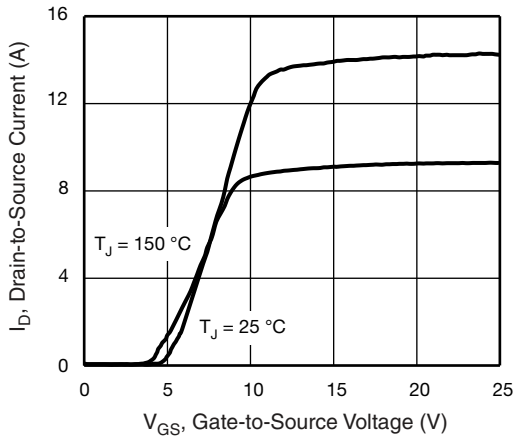

Fig. 3 - Typical Transfer Characteristics

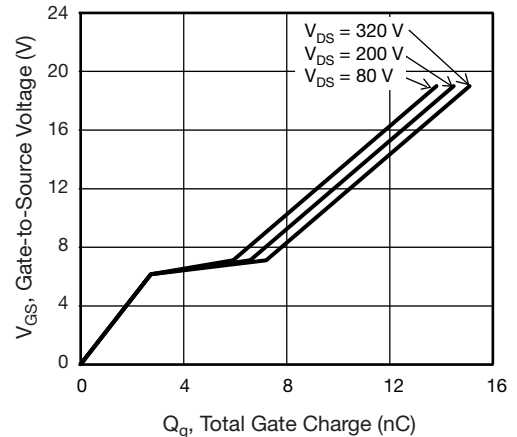

Fig. 6 - Typical Gate Charge vs. Gate-to-Source Voltage

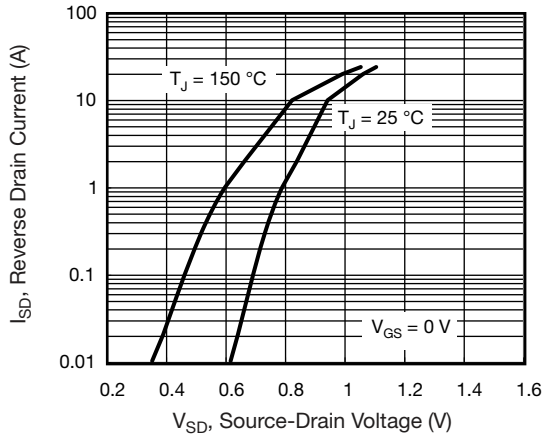

Fig. 7 - Typical Source-Drain Diode Forward Voltage

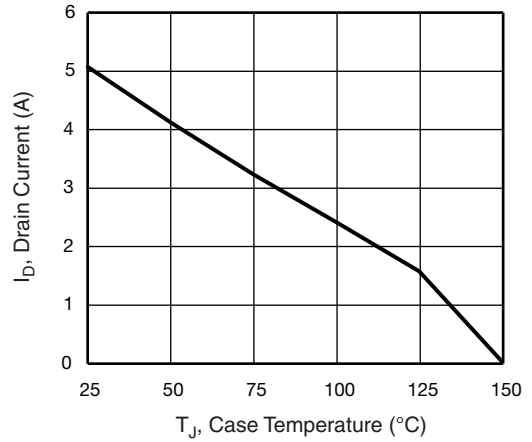

Fig. 9 - Maximum Drain Current vs. Case Temperature

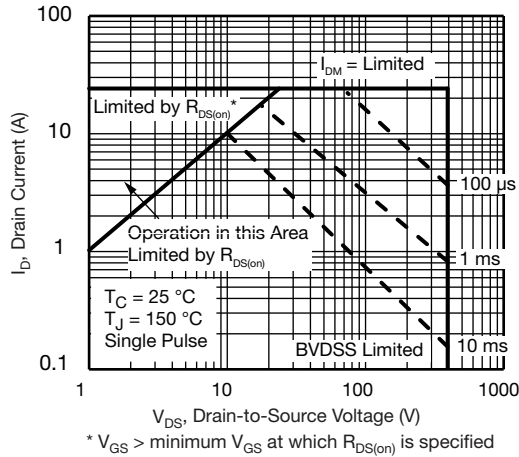

Fig. 8 - Maximum Safe Operating Area

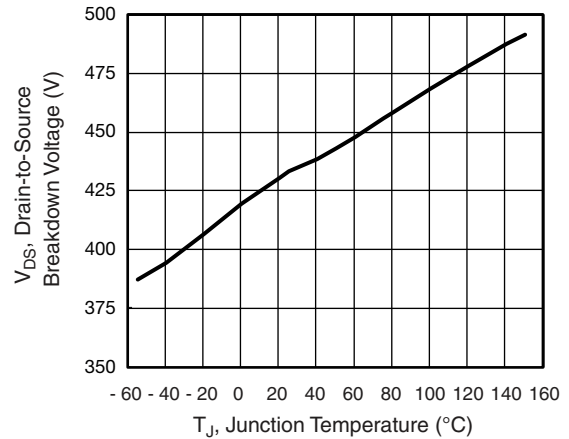

Fig. 10 - Temperature vs. Drain-to-Source Voltage

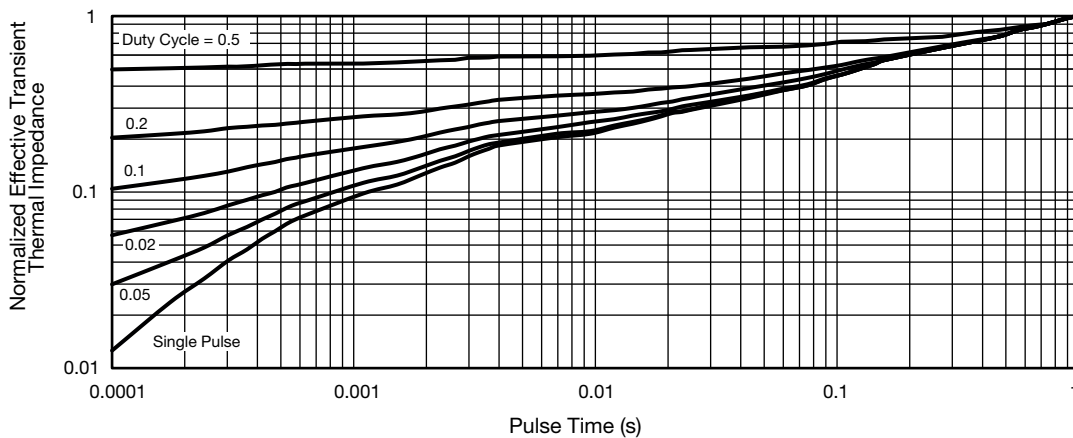

Fig. 11 - Normalized Thermal Transient Impedance, Junction-to-Case



Fig. 12 - Switching Time Test Circuit



Fig. 16 - Basic Gate Charge Waveform



Fig. 13 - Switching Time Waveforms



Fig. 17 - Gate Charge Test Circuit

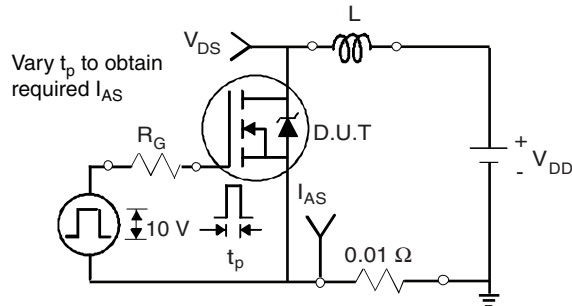

Fig. 14 - Unclamped Inductive Test Circuit

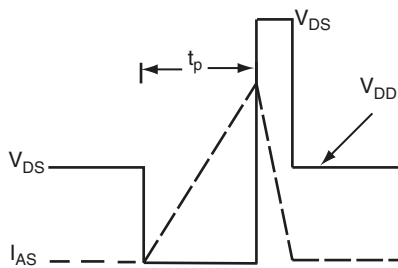

Fig. 15 - Unclamped Inductive Waveforms

Peak Diode Recovery dV/dt Test Circuit

Note

 a. $V_{GS} = 5 V$ for logic level devices

Fig. 18 - For N-Channel

Vishay Siliconix maintains worldwide manufacturing capability. Products may be manufactured at one of several qualified locations. Reliability data for Silicon Technology and Package Reliability represent a composite of all qualified locations. For related documents such as package/tape drawings, part marking, and reliability data, see www.vishay.com/ppg?91501.



TO-220 FULLPAK (High Voltage)

OPTION 1: FACILITY CODE = 9



DIM.	MILLIMETERS		
	MIN.	NOM.	MAX.
A	4.60	4.70	4.80
b	0.70	0.80	0.91
b1	1.20	1.30	1.47
b2	1.10	1.20	1.30
C	0.45	0.50	0.63
D	15.80	15.87	15.97
e	2.54 BSC		
E	10.00	10.10	10.30
F	2.44	2.54	2.64
G	6.50	6.70	6.90
L	12.90	13.10	13.30
L1	3.13	3.23	3.33
Q	2.65	2.75	2.85
Q1	3.20	3.30	3.40
$\varnothing R$	3.08	3.18	3.28

Notes

1. To be used only for process drawing
2. These dimensions apply to all TO-220 FULLPAK leadframe versions 3 leads
3. All critical dimensions should C meet $C_{pk} > 1.33$
4. All dimensions include burrs and plating thickness
5. No chipping or package damage
6. Facility code will be the 1st character located at the 2nd row of the unit marking



OPTION 2: FACILITY CODE = Y



DIM.	MILLIMETERS		INCHES	
	MIN.	MAX.	MIN.	MAX.
A	4.570	4.830	0.180	0.190
A1	2.570	2.830	0.101	0.111
A2	2.510	2.850	0.099	0.112
b	0.622	0.890	0.024	0.035
b2	1.229	1.400	0.048	0.055
b3	1.229	1.400	0.048	0.055
c	0.440	0.629	0.017	0.025
D	8.650	9.800	0.341	0.386
d1	15.88	16.120	0.622	0.635
d3	12.300	12.920	0.484	0.509
E	10.360	10.630	0.408	0.419
e	2.54 BSC		0.100 BSC	
L	13.200	13.730	0.520	0.541
L1	3.100	3.500	0.122	0.138
n	6.050	6.150	0.238	0.242
Ø P	3.050	3.450	0.120	0.136
u	2.400	2.500	0.094	0.098
V	0.400	0.500	0.016	0.020

ECN: E19-0180-Rev. D, 08-Apr-2019
DWG: 5972

Notes

1. To be used only for process drawing
2. These dimensions apply to all TO-220 FULLPAK leadframe versions 3 leads
3. All critical dimensions should C meet $C_{pk} > 1.33$
4. All dimensions include burrs and plating thickness
5. No chipping or package damage
6. Facility code will be the 1st character located at the 2nd row of the unit marking



Disclaimer

ALL PRODUCT, PRODUCT SPECIFICATIONS AND DATA ARE SUBJECT TO CHANGE WITHOUT NOTICE TO IMPROVE RELIABILITY, FUNCTION OR DESIGN OR OTHERWISE.

Vishay Intertechnology, Inc., its affiliates, agents, and employees, and all persons acting on its or their behalf (collectively, "Vishay"), disclaim any and all liability for any errors, inaccuracies or incompleteness contained in any datasheet or in any other disclosure relating to any product.

Vishay makes no warranty, representation or guarantee regarding the suitability of the products for any particular purpose or the continuing production of any product. To the maximum extent permitted by applicable law, Vishay disclaims (i) any and all liability arising out of the application or use of any product, (ii) any and all liability, including without limitation special, consequential or incidental damages, and (iii) any and all implied warranties, including warranties of fitness for particular purpose, non-infringement and merchantability.

Statements regarding the suitability of products for certain types of applications are based on Vishay's knowledge of typical requirements that are often placed on Vishay products in generic applications. Such statements are not binding statements about the suitability of products for a particular application. It is the customer's responsibility to validate that a particular product with the properties described in the product specification is suitable for use in a particular application. Parameters provided in datasheets and / or specifications may vary in different applications and performance may vary over time. All operating parameters, including typical parameters, must be validated for each customer application by the customer's technical experts. Product specifications do not expand or otherwise modify Vishay's terms and conditions of purchase, including but not limited to the warranty expressed therein.

Hyperlinks included in this datasheet may direct users to third-party websites. These links are provided as a convenience and for informational purposes only. Inclusion of these hyperlinks does not constitute an endorsement or an approval by Vishay of any of the products, services or opinions of the corporation, organization or individual associated with the third-party website. Vishay disclaims any and all liability and bears no responsibility for the accuracy, legality or content of the third-party website or for that of subsequent links.

Except as expressly indicated in writing, Vishay products are not designed for use in medical, life-saving, or life-sustaining applications or for any other application in which the failure of the Vishay product could result in personal injury or death. Customers using or selling Vishay products not expressly indicated for use in such applications do so at their own risk. Please contact authorized Vishay personnel to obtain written terms and conditions regarding products designed for such applications.

No license, express or implied, by estoppel or otherwise, to any intellectual property rights is granted by this document or by any conduct of Vishay. Product names and markings noted herein may be trademarks of their respective owners.