

- Low Loss Filter for ISM Band
- Complies with Directive 2002/95/EC (RoHS)
- Moisture Sensitivity Level: 1
- AEC-Q200 Qualified

RoHS
Compliant

SF2415E-1

**869.00 MHz
SAW Filter**

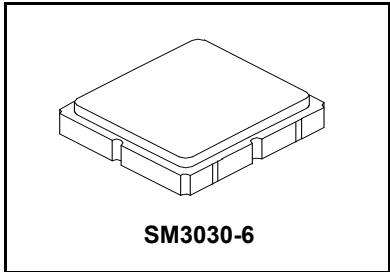

A1 Maximum Ratings

Rating	Value	Units
Input Power Level	20	dBm
DC Voltage	6	V
Operable Temperature Range	-45 to +125	°C
Storage Temperature Range in Tape and Reel	-40 to +85	°C
Specification Temperature Range	-40 to +80	°C
Soldering Profile Maximum Temperature, 5 cycles/10 s maximum	265	°C

B1 Electrical Characteristics

Characteristic	Sym	Notes	Min	Typ	Max	Units
Center Frequency	f_c			869.00		MHz
Insertion Loss, 868 to 870 MHz	IL			3.0	4.5	dB
Amplitude Ripple, 868 to 870 MHz				0.5	1.6	dB _{P-P}
VSWR, 868 to 870 MHz				1.5	2.5	
Attenuation Referenced to 0dB						dB
50 to 791 MHz			43	63		
791 to 835 MHz			41	57		
835 to 848 MHz			39	52		
848 to 862 MHz			18	40		
880 to 883 MHz			12	28		
883 to 1000 MHz			38	50		
Source Impedance	Z_S			50		Ω
Load Impedance	Z_L			50		Ω

Case Style	SM3030-6 3.0 x 3.0 mm Nominal Footprint		
Lid Symbolization, Y=year, WW=week, S=shift, Dot=pin 1 indicator	A1, <u>YWWS</u>		
Standard Reel Quantity	Reel Size 7 Inch	500 Pieces/Reel	
	Reel Size 13 Inch	3000 Pieces/Reel	

Electrical Connections

Connection	Terminals
Port 1 (Input)	2
Port 2 (Output)	5
Case Ground	All others

Test Circuit

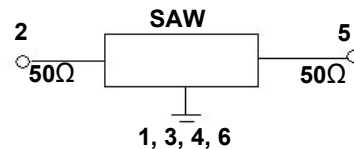

CAUTION: Electrostatic Sensitive Device. Observe precautions for handling.
NOTES:

1. The design, manufacturing process, and specifications of this device are subject to change.
2. US or International patents may apply.
3. RoHS compliant from the first date of manufacture.

Frequency Characteristics

S21 response: (Span 200 MHz)

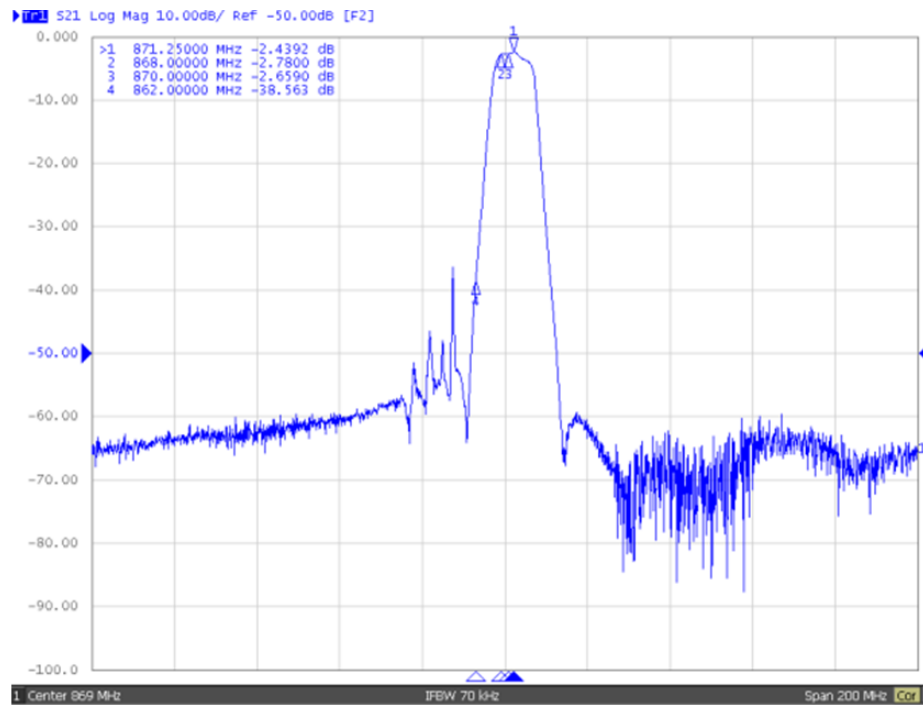

S21 response: (Span 20 MHz)

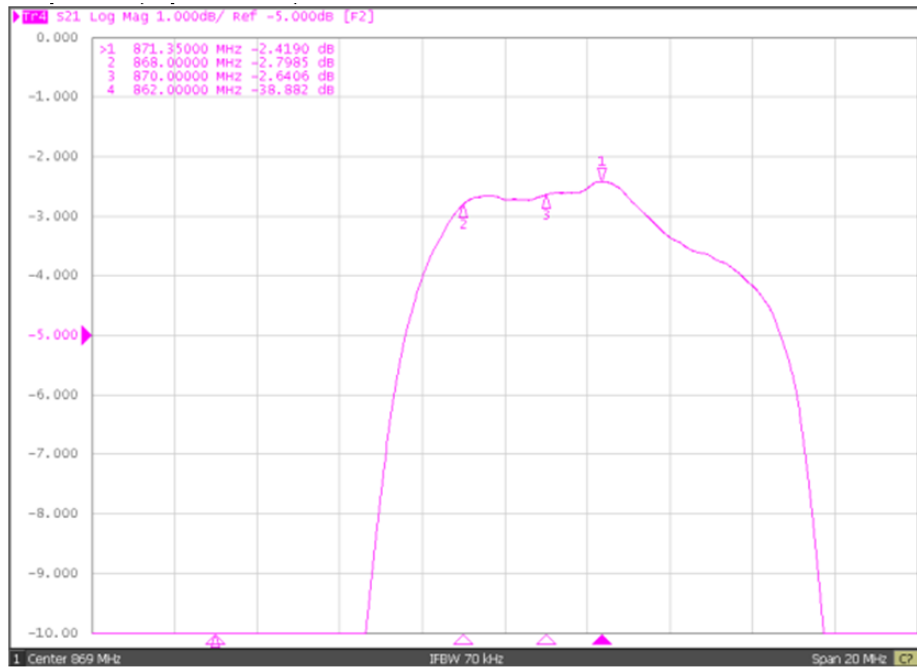

Frequency Characteristics

S21 response: (Span 3 GHz)

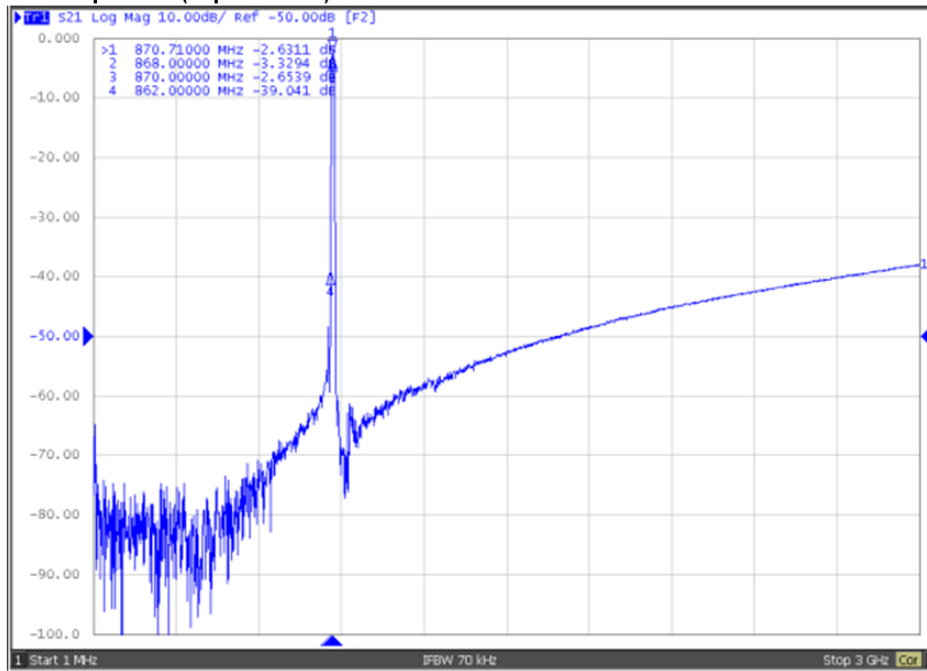

S11/S22 response:

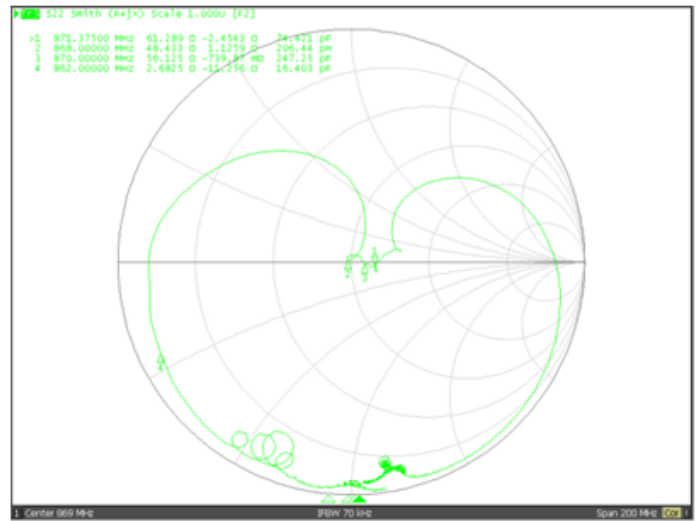
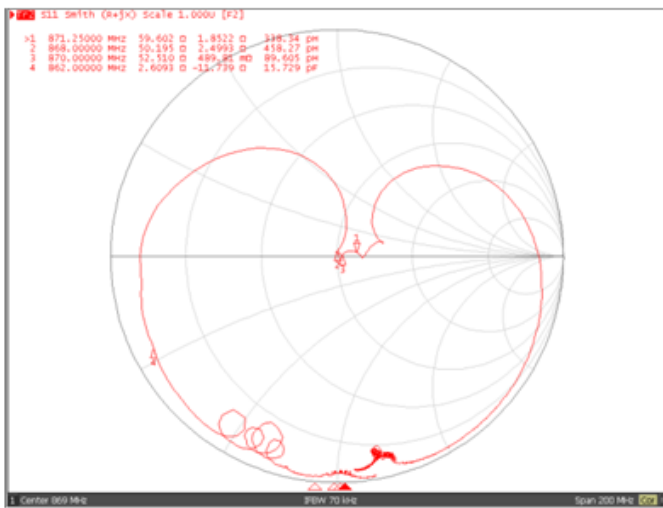

SM3030-6 Case

6-Terminal Ceramic Surface-Mount Case 3.0 X 3.0 mm Nominal Footprint

Case and PCB Footprint Dimensions

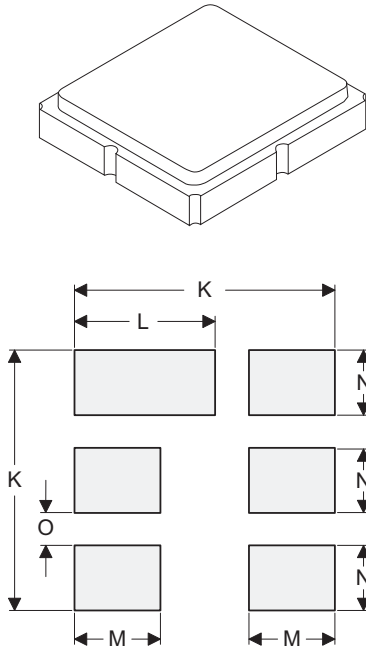

PCB Footprint Top View

Dimension	mm			Inches		
	Min	Nom	Max	Min	Nom	Max
A	2.87	3.00	3.13	0.113	0.118	0.123
B	2.87	3.00	3.13	0.113	0.118	0.123
C	1.12	1.25	1.38	0.044	0.049	0.054
D	0.77	0.90	1.03	0.030	0.035	0.040
E	2.67	2.80	2.93	0.105	0.110	0.115
F	1.47	1.60	1.73	0.058	0.063	0.068
G	0.72	0.85	0.98	0.028	0.033	0.038
H	1.37	1.50	1.63	0.054	0.059	0.064
I	0.47	0.60	0.73	0.019	0.024	0.029
J	1.17	1.30	1.43	0.046	0.051	0.056
K	-	3.20	-	-	0.126	-
L	-	1.70	-	-	0.067	-
M	-	1.05	-	-	0.041	-
N	-	0.81	-	-	0.032	-
O	-	0.38	-	-	0.015	-
P	0.15	0.30	0.45	0.005	0.011	0.017
Q	0.07	0.20	0.36	0.002	0.007	0.014
R	0.62	0.7	0.78	0.024	0.027	0.030

Case Materials

Materials	
Solder Pad Plating	0.3 to 1.0 μ m Gold over 1.27 to 8.89 μ m Nickel
Lid Plating	2.0 to 3.0 μ m Nickel
Body	Al ₂ O ₃ Ceramic

Electrical Connections

Connection	Terminals
Input	2
Output	5
Case Ground	All others

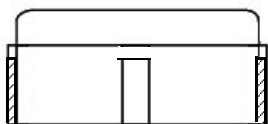
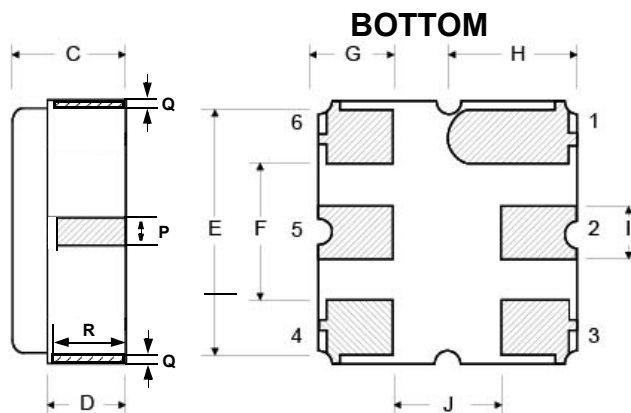
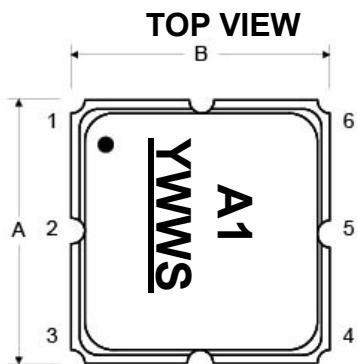

Tape and Reel Specifications

Tape and Reel Standard per ANSI/EIA-481

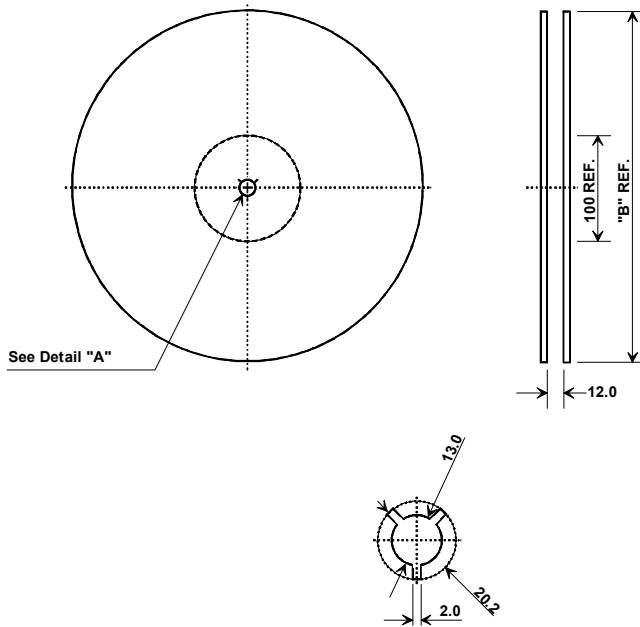

"B"		Quantity Per Reel
Inches	millimeters	
7	178	500
13	330	3000

COMPONENT ORIENTATION and DIMENSIONS

Carrier Tape Dimensions	
Ao	3.3 mm
Bo	3.3 mm
Ko	1.4 mm
Pitch	4.0 mm
W	12.0 mm

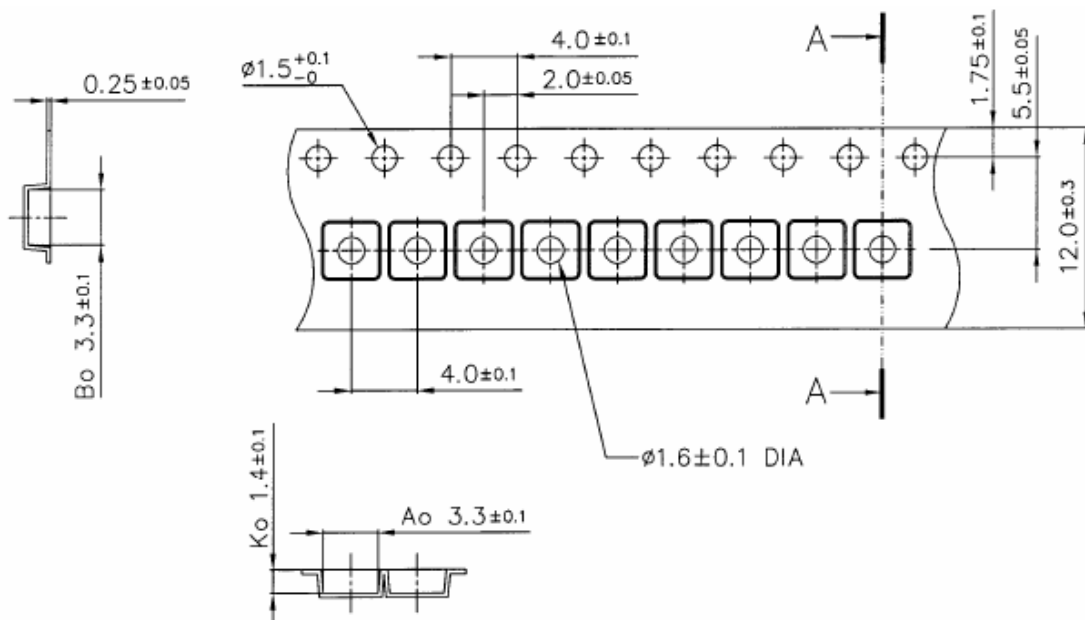

Recommended Reflow Profile

1. Preheating shall be fixed at 150~180°C for 60~90 seconds.
2. Ascending time to preheating temperature 150°C shall be 30 seconds min.
3. Heating shall be fixed at 220°C for 50~80 seconds and at 260°C +0/-5°C peak (10 seconds).
4. Time: 5 times maximum.

