

- **Low-loss SAW Filter**
- **Surface Mount 3.0 x 3.0 x 1.3 mm Package**
- **Complies with Directive 2002/95/EC (RoHS)**
- **Moisture Sensitivity Level: 1**

#### Absolute Maximum Ratings

Rating	Value	Units
Input Power Level	+17	dBm
DC Voltage on any Non-ground Terminal	5	V
Operable Temperature Range	-45 to +125	°C
Specification Temperature Range	-30 to +85	°C
Storage Temperature Range in Tape and Reel	-40 to +85	°C
Maximum Soldering Profile, 5 cycles/10 seconds maximum	265	°C

**SF2201E**

**916.45 MHz  
SAW Filter**

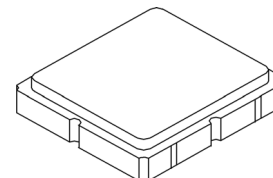

**SM3030-6**

#### Electrical Characteristics

Characteristic	Sym	Notes	Min	Typ	Max	Units
Center Frequency	$F_C$			916.45		MHz
Insertion Loss, 914.45 to 918.45 MHz	IL			2.7	3.5	dB
Amplitude Ripple, 914.45 to 918.45 MHz				0.3	1.0	dB <sub>P-P</sub>
VSWR, 914.45 to 918.45 MHz				1.5:1	2.0:1	
Attenuation Referenced to 0 dB						
DC to 600 MHz			50	57		dB
600 to 840 MHz			40	51		
869 to 894 MHz			35	46		
970 to 1500 MHz			40	47		
1500 to 3000 MHz			25	32		
Source Impedance	$Z_S$			50		$\Omega$
Load Impedance	$Z_L$			50		
Case Style	SM3030-6 3.0 x 3.0 mm Nominal Footprint					
Lid Symbolization (Y=year, WW=week, S=shift) dot=pin 1 indicator	931, <u>YWWS</u>					

#### Electrical Connections

Connection	Terminals
Input	2
Output	5
Ground	All Others

 **CAUTION: Electrostatic Sensitive Device. Observe precautions for handling.**

#### NOTES:

1. The design, manufacturing process, and specifications of this device are subject to change.
2. US or International patents may apply.
3. RoHS compliant from the first date of manufacture.

# Filter Passband Response

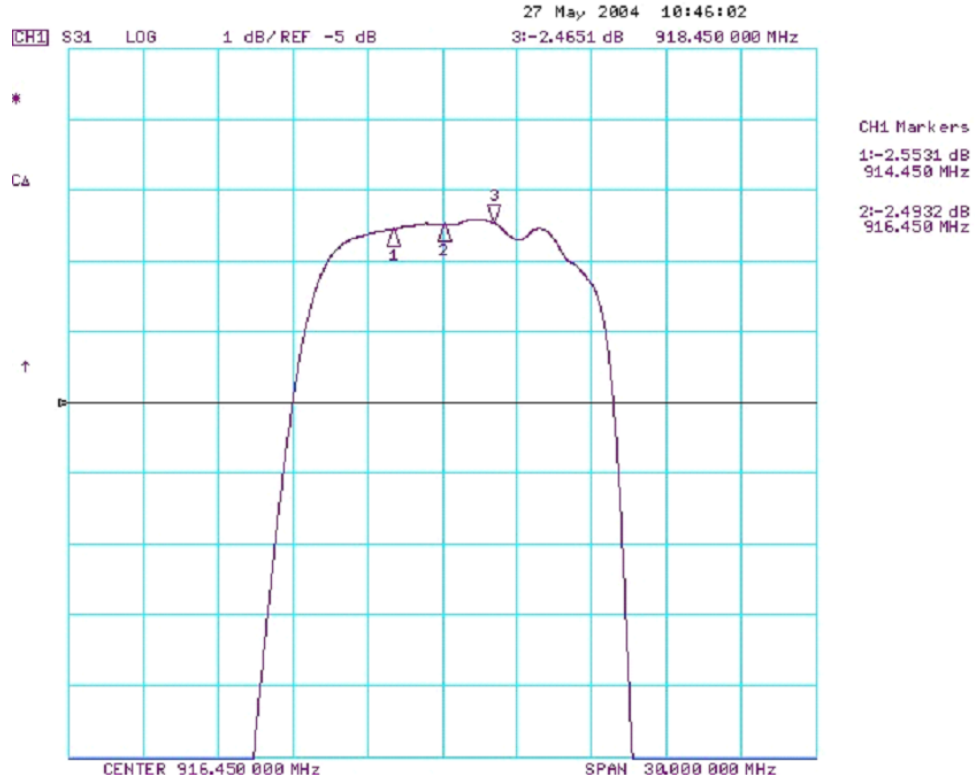

# Filter Test Circuit

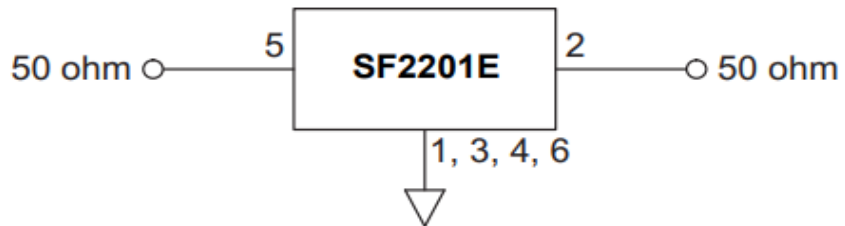

## Filter Response, 816.45 to 1016.45 MHz

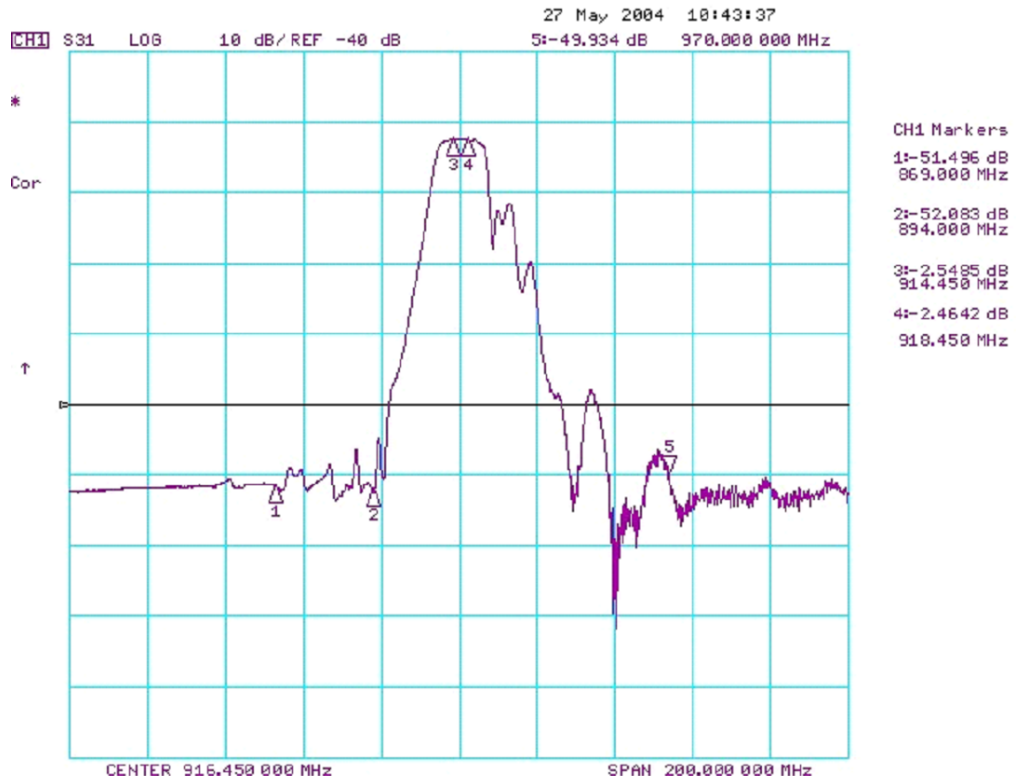

## Filter Broadband Response, 0.01 to 3000 MHz

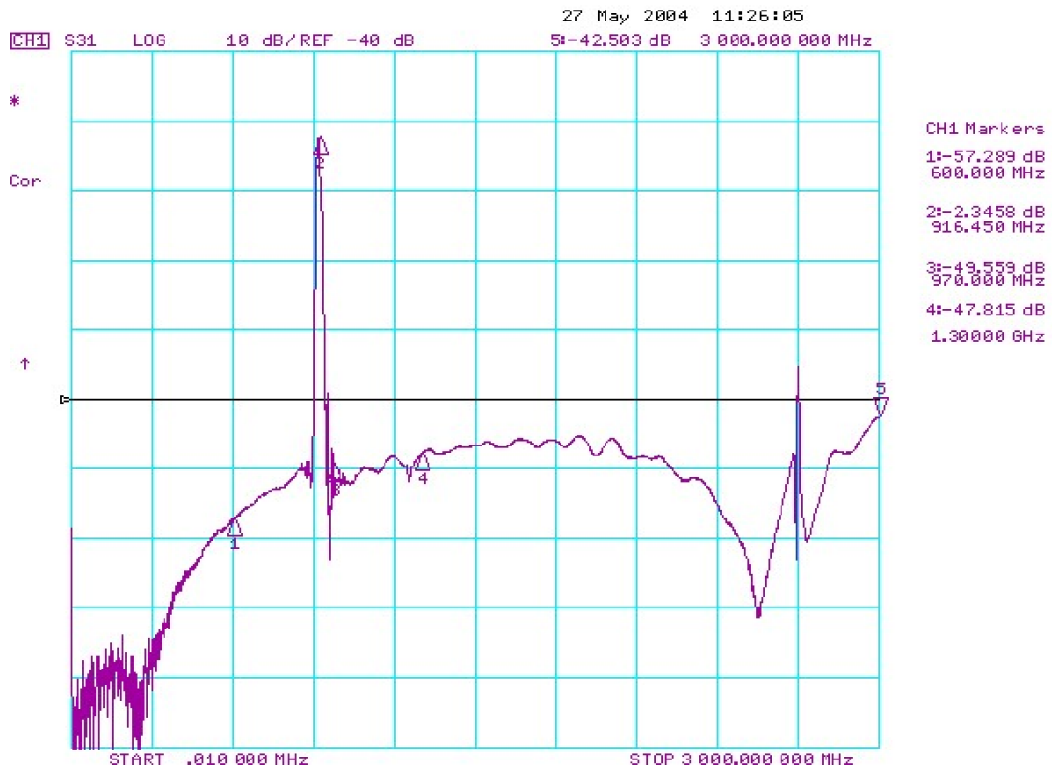

# Filter S<sub>11</sub> Plot

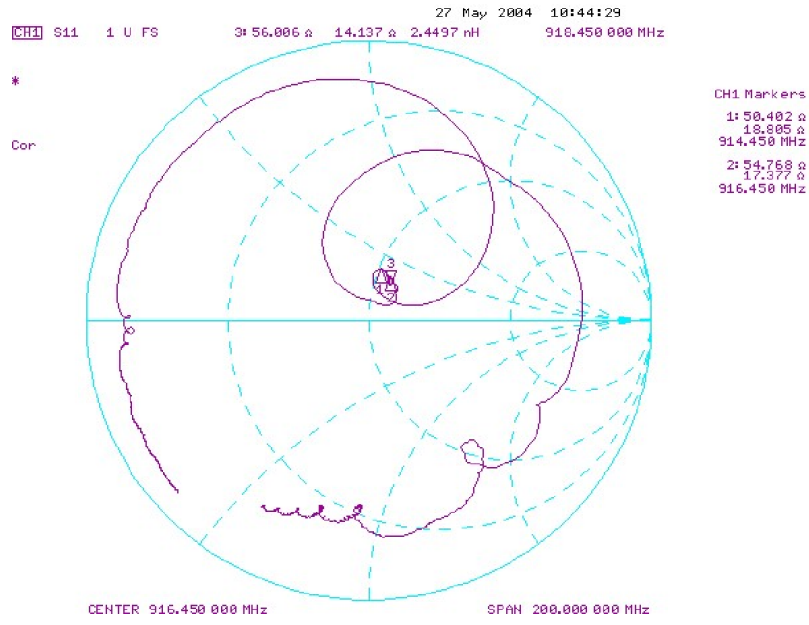

# Filter S<sub>22</sub> Plot

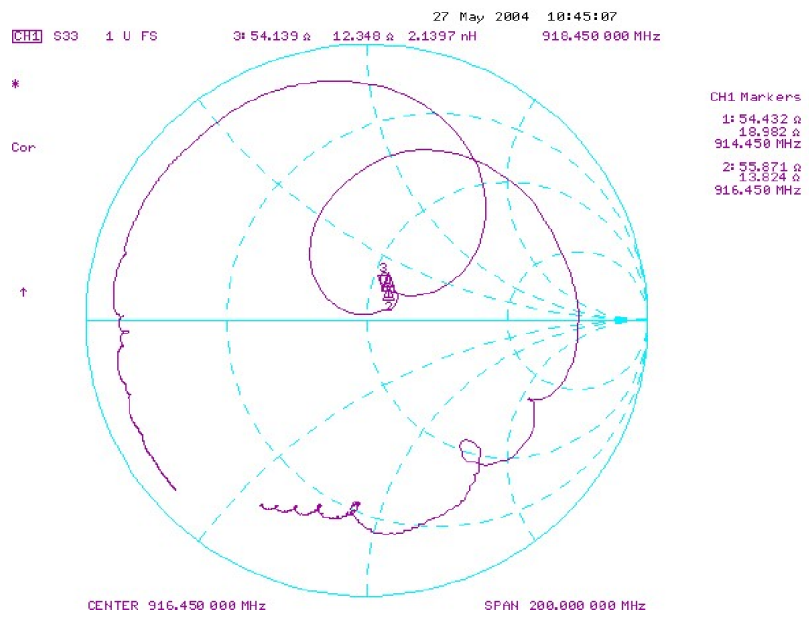

# SM3030-6 Case

## 6-Terminal Ceramic Surface-Mount Case 3.0 X 3.0 mm Nominal Footprint

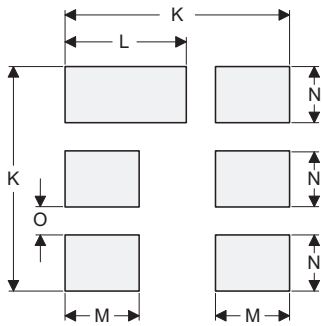
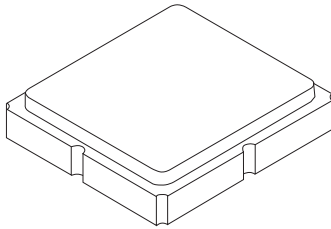

PCB Footprint Top View

### Case and PCB Footprint Dimensions

Dimension	mm			Inches		
	Min	Nom	Max	Min	Nom	Max
A	2.87	3.00	3.13	0.113	0.118	0.123
B	2.87	3.00	3.13	0.113	0.118	0.123
C	1.12	1.25	1.38	0.044	0.049	0.054
D	0.77	0.90	1.03	0.030	0.035	0.040
E	2.67	2.80	2.93	0.105	0.110	0.115
F	1.47	1.60	1.73	0.058	0.063	0.068
G	0.72	0.85	0.98	0.028	0.033	0.038
H	1.37	1.50	1.63	0.054	0.059	0.064
I	0.47	0.60	0.73	0.019	0.024	0.029
J	1.17	1.30	1.43	0.046	0.051	0.056
K		3.20			0.126	
L		1.70			0.067	
M		1.05			0.041	
N		0.81			0.032	
O		0.38			0.015	

### Case Materials

Materials	
Solder Pad Plating	0.3 to 1.0 $\mu\text{m}$ Gold over 1.27 to 8.89 $\mu\text{m}$ Nickel
Lid Plating	2.0 to 3.0 $\mu\text{m}$ Nickel
Body	$\text{Al}_2\text{O}_3$ Ceramic

### TOP VIEW

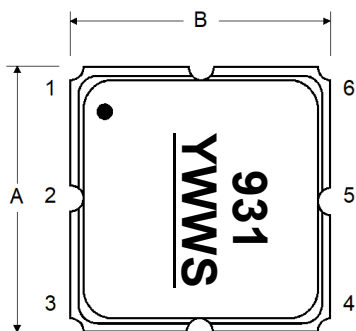

### BOTTOM VIEW

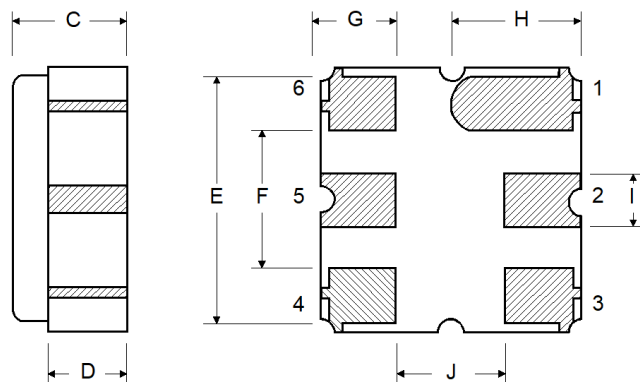

## Tape and Reel Specifications

Tape and Reel Standard per ANSI/EIA-481

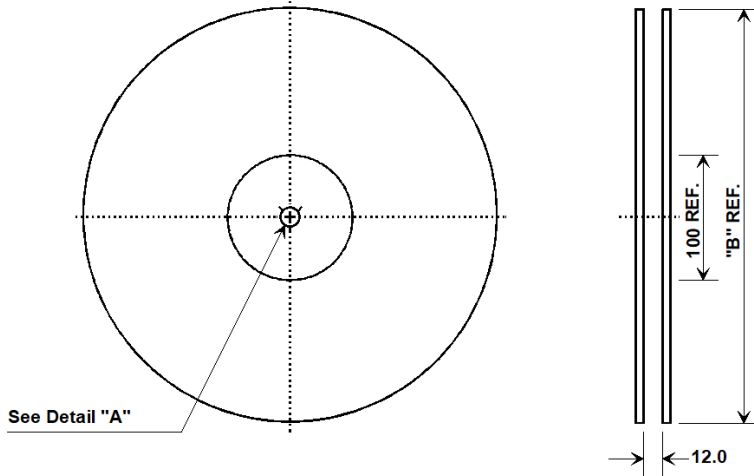

"B"		Quantity Per Reel
Inches	millimeters	
7	178	500
13	330	3000

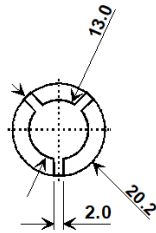

### COMPONENT ORIENTATION and DIMENSIONS

Carrier Tape Dimensions	
Ao	3.35 mm
Bo	3.35 mm
Ko	1.40 mm
Pitch	8.0 mm
W	12.0 mm

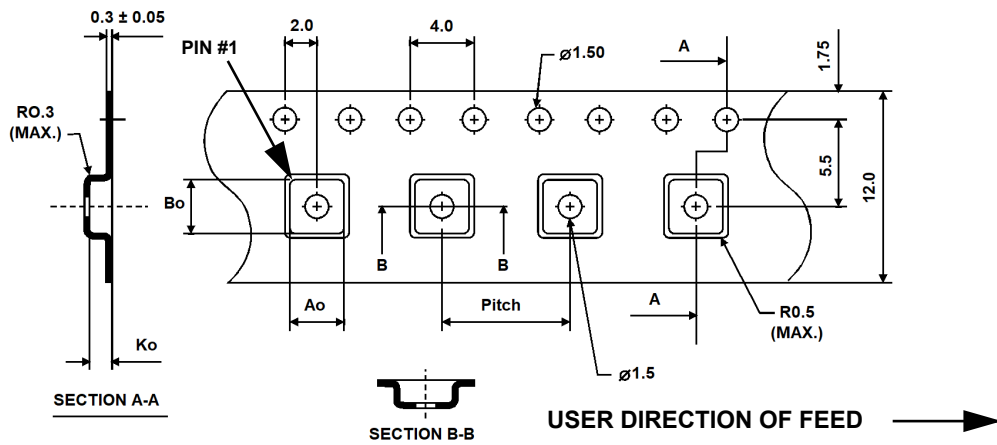

## Recommended Reflow Profile

1. Preheating shall be fixed at 150~180°C for 60~90 seconds.
2. Ascending time to preheating temperature 150°C shall be 30 seconds min.
3. Heating shall be fixed at 220°C for 50~80 seconds and at 260°C +0/-5°C peak (10 seconds).
4. Time: 5 times maximum.

