

SF2177E

**1472 MHz
SAW Filter**

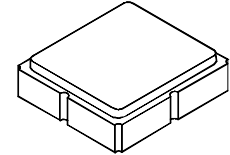

SM3030-8

- **Low-loss UHF SAW Filter**
- **Complies with Directive 2002/95/EC (RoHS)**
- **Moisture Sensitivity Level: 1**

Characteristics:

Single-ended source impedance : $Z_S = 50 \Omega$

Balanced load impedance : $Z_L = 100 \Omega$

Maximum Rating

Rating	Value	Units
Input Power Level	+10	dBm
DC Voltage on any Non-ground Terminal	3	V
Operating Temperature Range	-40 to +85	°C
Tape and Reel Storage Temperature Range	-40 to +85	°C
Component Storage Temperature Range	-50 to +95	°C
Solder Reflow Temperature, 10 seconds/5 cycles maximum	260	°C

Characteristic	Sym	Notes	Min	Typ	Max	Units
Center Frequency	f_C			1472		MHz
Insertion Loss, 1452 to 1492 MHz	IL			3.2	4.5	dB
Amplitude Ripple, 1452 to 1492 MHz				1.0	2.0	
Group Delay Ripple, 1452 to 1492 MHz				8	40	ns _{p-p}
Input Return Loss, 1452 to 1492 MHz			6.5	8.0		dB
Output Return Loss, 1452 to 1492 MHz			8.8	10.5		
Attenuation, 0 dB Reference:						dB
880 to 915 MHz			50	54		
1410 MHz			30	35		
1530 to 1570 MHz			15	29		
1575 MHz			30	38		
1710 to 1785 MHz			35	40		
1920 to 1980 MHz			35	37.5		
2400 to 2500 MHz			26	31.5		

Case Style	SM3030-8 3.0 x 3.0 mm Nominal Footprint
Lid Symbolization, Y=year, WW=week, S=shift, dot=pin 1 indicator	866, <u>YWWS</u>



CAUTION: Electrostatic Sensitive Device. Observe precautions for handling.

NOTES:

1. The design, manufacturing process, and specifications of this device are subject to change.
2. US or International patents may apply.
3. RoHS compliant from the first date of manufacture.

Filter Passband Amplitude and Group Delay Plots

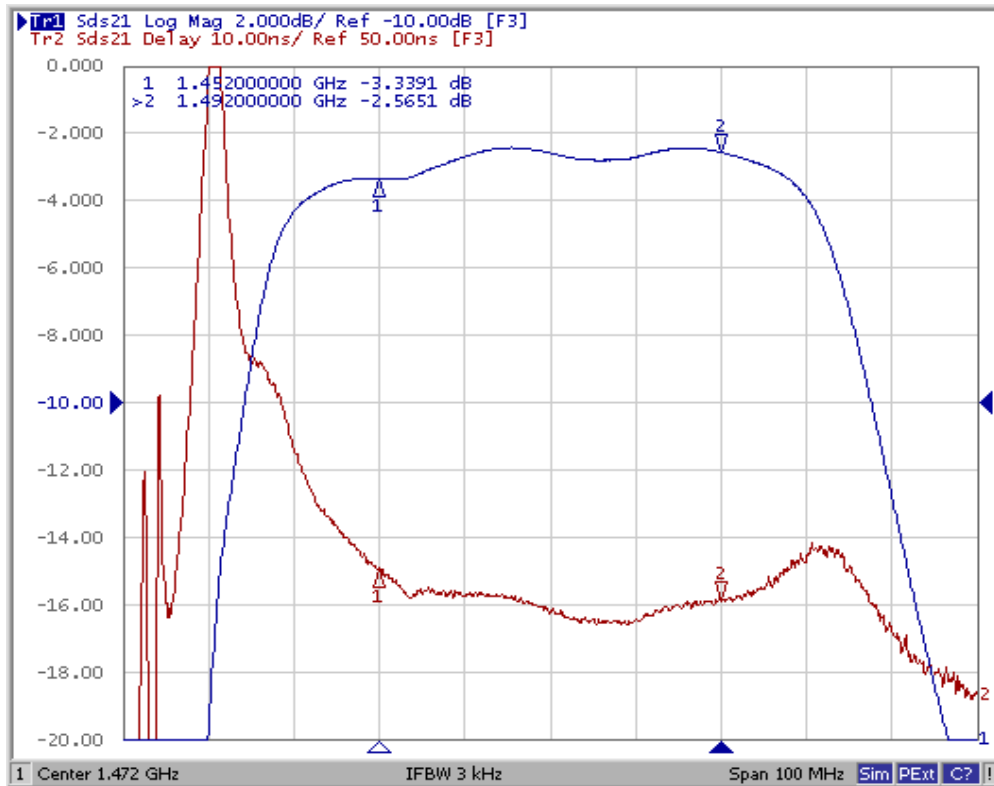

Filter Broadband Plot

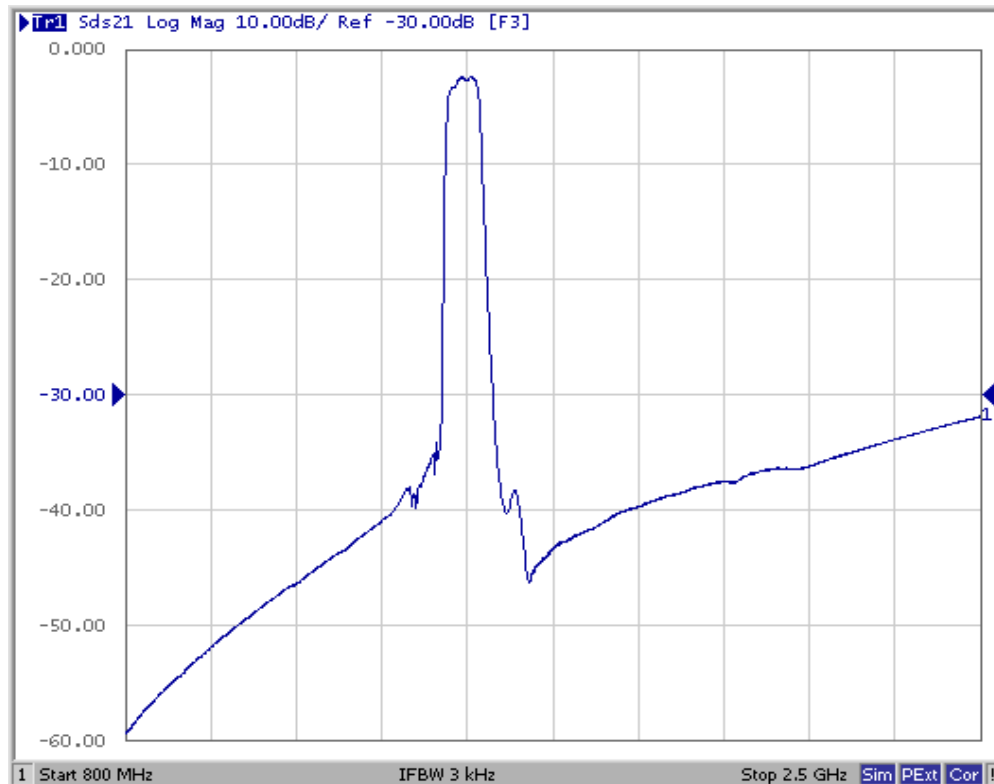

Filter Input Return Loss

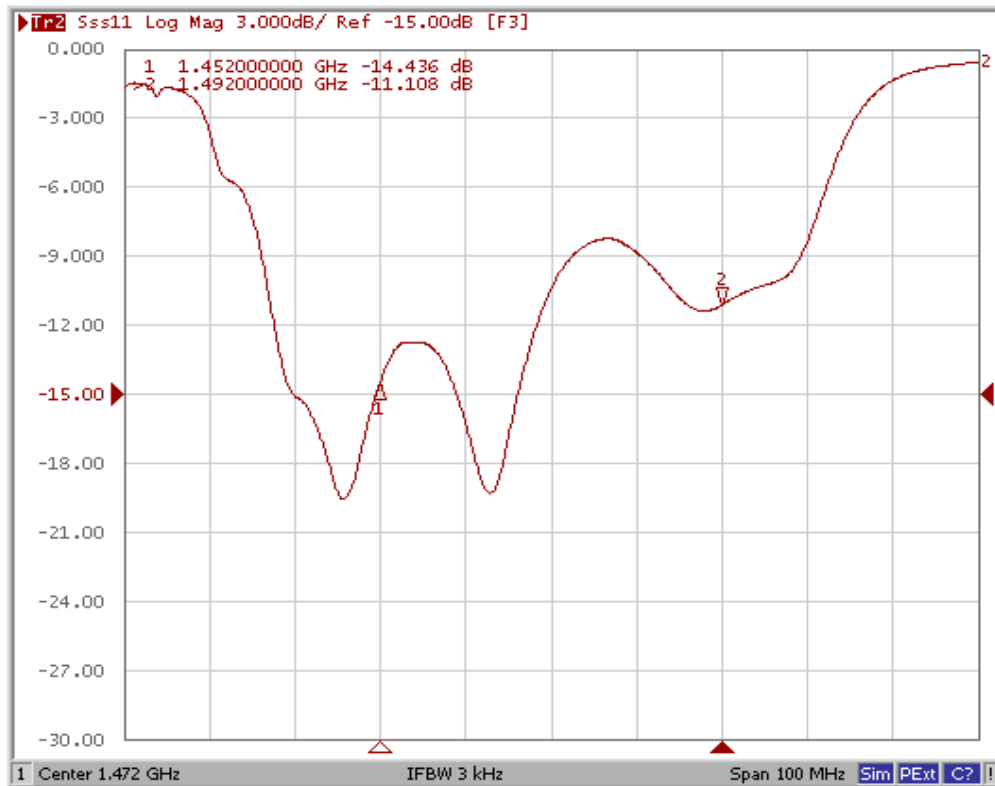

Filter Output Return Loss

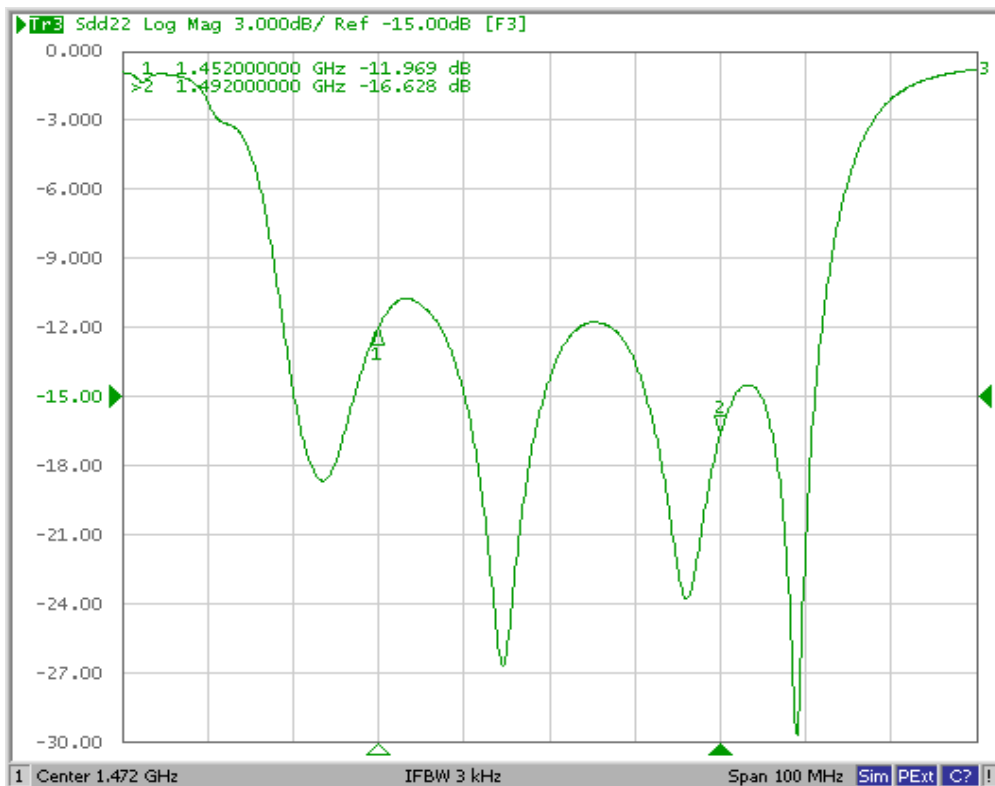

8-Terminal Ceramic Surface-Mount Case 3.0 X 3.0 mm Nominal Footprint

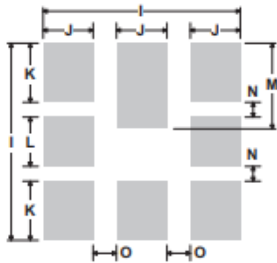
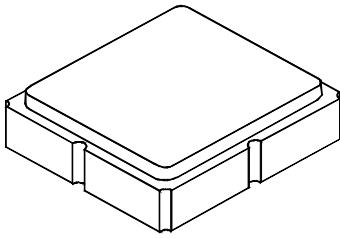

PCB Footprint Top View

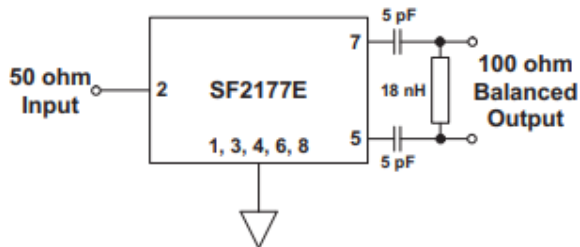

Case and PCB Footprint Dimensions

Dimension	mm			Inches		
	Min	Nom	Max	Min	Nom	Max
A	2.87	3.00	3.13	0.113	0.118	0.123
B	2.87	3.00	3.13	0.113	0.118	0.123
C	-	-	1.10	-	-	0.043
D	0.79	0.92	1.05	0.031	0.036	0.041
E	0.62	0.75	0.88	0.024	0.029	0.034
F	0.47	0.60	0.73	0.018	0.024	0.029
G	0.47	0.60	0.73	0.018	0.024	0.029
H	1.07	1.20	1.33	0.042	0.047	0.052
I		3.19			0.126	
J		0.81			0.032	
K		0.96			0.038	
L		0.81			0.032	
M		1.39			0.055	
N		0.23			0.009	
O		0.38			0.015	

Case Materials

Materials	
Solder Pad Plating	0.3 to 1.0 μm Gold over 1.27 to 8.89 μm Nickel
Lid Plating	2.0 to 3.0 μm Nickel
Body	Al_2O_3 Ceramic

TOP VIEW

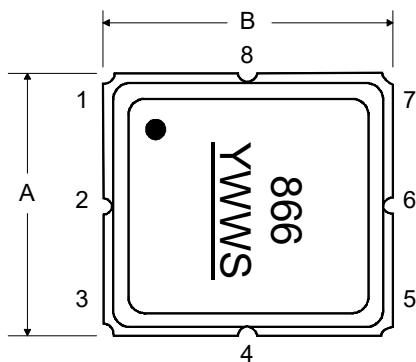

BOTTOM VIEW

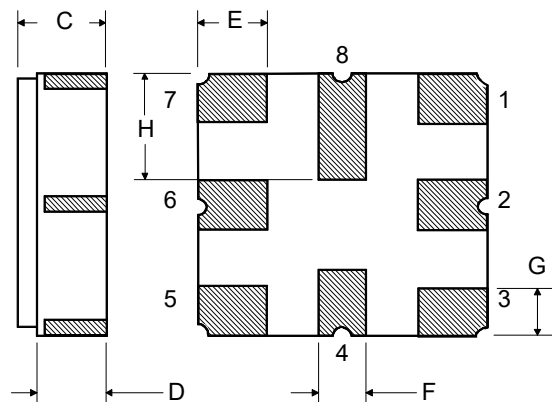

Tape and Reel Specifications

Tape and Reel Standard per ANSI/EIA-481

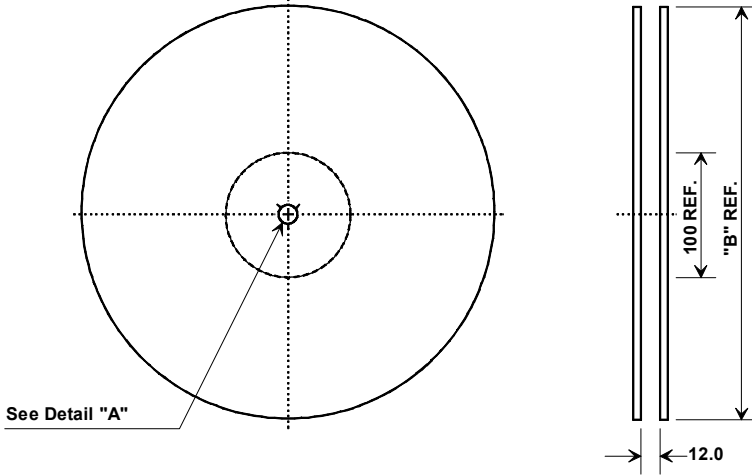

"B"		Quantity Per Reel
Nominal Size		
Inches	millimeters	
7	178	500
13	330	3000

Carrier Tape Dimensions	
Ao	3.35 mm
Bo	3.35 mm
Ko	1.4 mm
Pitch	8.0 mm
W	12.0 mm

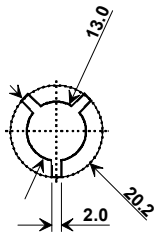

COMPONENT ORIENTATION and DIMENSIONS

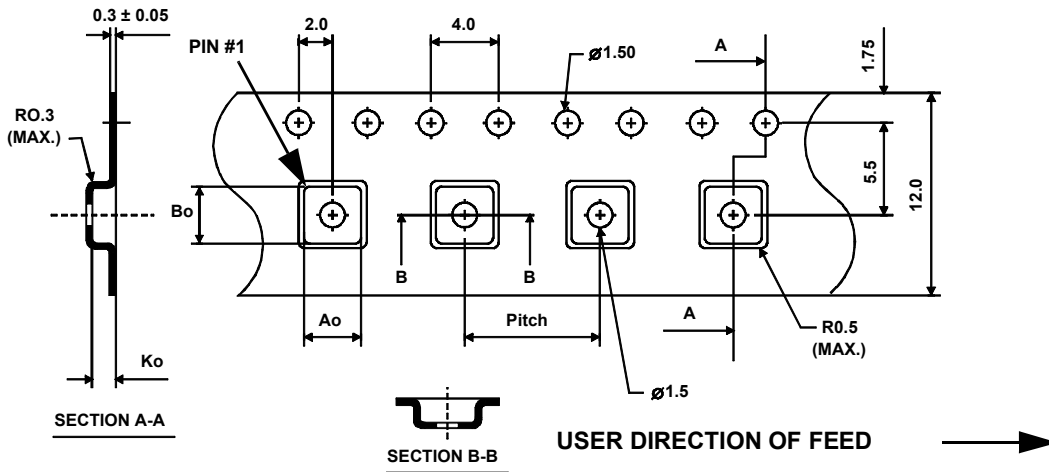

Recommended Reflow Profile

1. Preheating shall be fixed at 150~180°C for 60~90 seconds.
2. Ascending time to preheating temperature 150°C shall be 30 seconds min.
3. Heating shall be fixed at 220°C for 50~80 seconds and at 260°C +0/-5°C peak (10 seconds).
4. Time: 5 times maximum.

