

---

## 600mA Step-down DC/DC Converter with Synchronous Rectifier

---

NO.EA-305-230525

### OUTLINE

The RP507K001B is a CMOS-based 600mA<sup>(1)</sup> step-down DC/DC converter with synchronous rectifier. Internally, a single converter consists of an oscillator, a reference voltage unit, an error amplifier, a switching control circuit, a soft-start circuit, an under voltage lockout (UVLO) circuit, an over current protection circuit, a thermal shutdown circuit and switching transistors.

Replacing diodes with built-in switching transistors improves the efficiency of rectification. Therefore, by simply using an inductor, resistors and capacitors as the external components, a low ripple high efficiency synchronous rectifier step-down DC/DC converter can be easily configured.

The RP507K001B has an over current protection circuit which supervises the inductor peak current in each switching cycle, and turns the high-side driver off if the current exceeds the Lx current limit. The RP507K001B also contains a thermal shutdown circuit which detects overheating of the converter and stops the converter operation to protect it from damage if the junction temperature exceeds the specified temperature.

The RP507K001B is PWM/VFM auto switching control in which mode automatically switches from PWM mode to high-efficiency VFM mode in low output current.

The RP507K001B is available in DFN(PL)1616-6D package which achieves high-density mounting on boards. For an input capacitor (C<sub>IN</sub>) and an output capacitor (C<sub>OUT</sub>), the smaller sized 0402/1005 (inch/ mm) capacitor can be used. Output voltage is adjustable with external divider resistors.

### FEATURES

- Input Voltage Range ..... 2.3V to 5.5V (Absolute maximum rating: 6.5V)
- Output Voltage Range ..... 0.7V to 5.5V  
(Note: As for 1.0V or less, input voltage range is limited.)
- Feedback Voltage Accuracy ..... ±9mV (V<sub>FB</sub>=0.6V)
- Temperature-Drift Coefficient of Feedback Voltage  
..... Typ. ±100ppm/°C
- Oscillator Frequency ..... Typ. 2.0MHz
- Maximum Duty Cycle ..... 100%
- Built-in Driver ON Resistance ..... Typ. Pch. 0.38Ω, Nch. 0.3Ω (V<sub>IN</sub>=3.6V)
- Supply Current (at no load)..... Typ. 34μA
- Standby Current..... Max. 5μA
- UVLO Detector Threshold..... Typ. 2.0V
- Soft-start Time..... Typ. 150μs
- Lx Current Limit Circuit..... Typ. 1A
- Package ..... DFN(PL)1616-6D

---

<sup>(1)</sup> This is an approximate value, because output current depends on conditions and external components.

---

## APPLICATIONS

- Power source for portable equipment such as cellular, PDA, DSC, Notebook PC, smartphone
- Power source for Li-ion battery-used equipment

## SELECTION GUIDE

Product Name	Package	Quantity per Reel	Pb Free	Halogen Free
RP507K001B-TR	DFN(PL)1616-6D	5,000pcs	Yes	Yes

Output voltage ( $V_{SET}$ ) is adjustable with external divider resistors.

Recommended output voltage range is from 0.7V to 5.5V.

RP507K001B has an auto-discharge function<sup>(1)</sup>.

## BLOCK DIAGRAMS

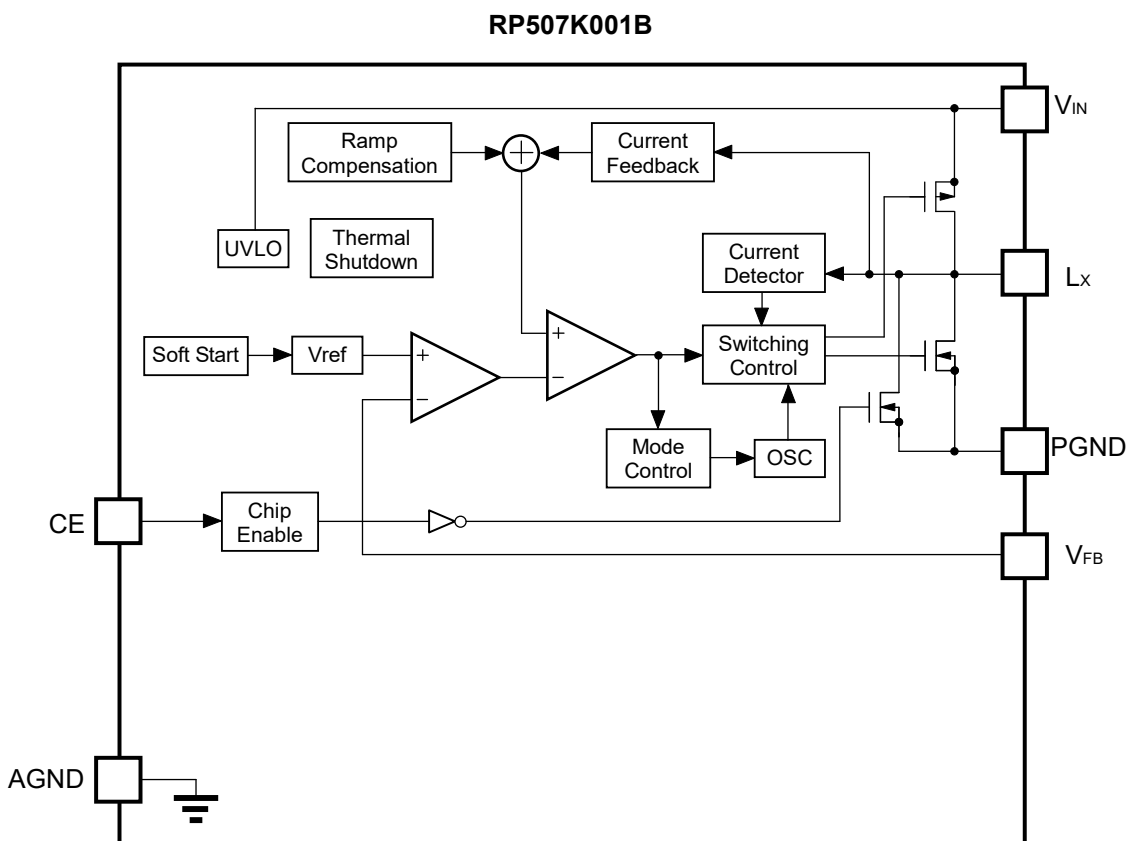

<sup>(1)</sup> Auto-discharge function quickly lowers the output voltage to 0V, when the chip enable signal is switched from the active mode to the standby mode, by releasing the electrical charge accumulated in the external capacitor.

## PIN DESCRIPTIONS

• DFN(PL)1616-6D

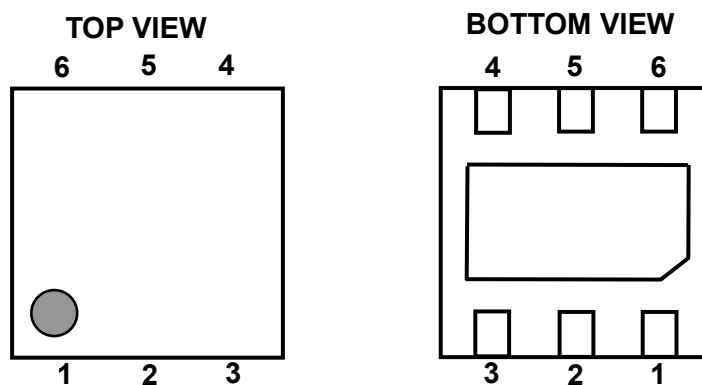

### RP507K: DFN(PL)1616-6D

Pin No.	Symbol	Description
1	CE	Chip Enable Pin ("H" Active)
2	AGND	Ground Pin <sup>(1)</sup>
3	PGND	Ground Pin <sup>(1)</sup>
4	L <sub>x</sub>	L <sub>x</sub> Switching Pin
5	V <sub>IN</sub>	Input Pin
6	V <sub>FB</sub>	Feedback Pin

The exposed tab on the bottom of the package enhances thermal performance and is electrically connected to GND (substrate level). It is recommended that the exposed tab be connected to the ground plane on the board or otherwise be left open.

<sup>(1)</sup> No.2 pin and No.3 pin must be wired to the GND plane when mounting on boards.

## ABSOLUTE MAXIMUM RATINGS

### Absolute Maximum Ratings

(AGND=PGND=0V)

Symbol	Item	Rating	Unit
V <sub>IN</sub>	V <sub>IN</sub> Input Voltage	-0.3 to 6.5	V
V <sub>LX</sub>	L <sub>x</sub> Pin Voltage	-0.3 to V <sub>IN</sub> + 0.3	V
V <sub>CE</sub>	CE Pin Input Voltage	-0.3 to 6.5	V
V <sub>FB</sub>	V <sub>FB</sub> Pin Voltage	-0.3 to 6.5	V
I <sub>LX</sub>	L <sub>x</sub> Pin Output Current	1	A
P <sub>D</sub>	Power Dissipation <sup>(1)</sup> (DFN(PL)1616-6D, JEDEC STD. 51-7)	1580	mW
T <sub>j</sub>	Junction Temperature	-40 to 125	°C
T <sub>stg</sub>	Storage Temperature Range	-55 to 125	°C

### ABSOLUTE MAXIMUM RATINGS

Electronic and mechanical stress momentarily exceeded absolute maximum ratings may cause the permanent damages and may degrade the life time and safety for both device and system using the device in the field. The functional operation at or over these absolute maximum ratings are not assured.

## RECOMMENDED OPERATING CONDITIONS

### Recommended Operating Conditions

Symbol	Item	Rating	Unit
V <sub>IN</sub>	Input Voltage	1.0V ≤ V <sub>SET</sub> <sup>(2)</sup>	V
		0.9V ≤ V <sub>SET</sub> < 1.0V	
		0.7V ≤ V <sub>SET</sub> < 0.9V	
T <sub>a</sub>	Operating Temperature Range	-40 to 85	°C

### RECOMMENDED OPERATING CONDITIONS

All of electronic equipment should be designed that the mounted semiconductor devices operate within the recommended operating conditions. The semiconductor devices cannot operate normally over the recommended operating conditions, even if when they are used over such ratings by momentary electronic noise or surge. And the semiconductor devices may receive serious damage when they continue to operate over the recommended operating conditions.

<sup>(1)</sup> Refer to *POWER DISSIPATION* for detailed information.

<sup>(2)</sup> V<sub>SET</sub>= Set Output Voltage

## ELECTRICAL CHARACTERISTICS

### ● RP507K001B

(Ta=25°C)

Symbol	Item	Conditions	Min.	Typ.	Max.	Unit
V <sub>FB</sub>	Feedback Output Voltage	V <sub>IN</sub> =V <sub>CE</sub> =3.6V	0.591	0.600	0.609	V
ΔV <sub>FB</sub> /ΔT	Feedback Output Voltage Temperature Coefficient	-40°C ≤ Ta ≤ 85°C		±100		ppm/°C
f <sub>osc</sub>	Oscillator Frequency	V <sub>IN</sub> =V <sub>CE</sub> =3.6V (V <sub>SET</sub> <sup>(1)</sup> ≤2.6V), V <sub>IN</sub> =V <sub>CE</sub> =V <sub>SET</sub> +1V (V <sub>SET</sub> >2.6V)	1.7	2.0	2.3	MHz
I <sub>DD</sub>	Supply Current	V <sub>IN</sub> =V <sub>CE</sub> =V <sub>FB</sub> =3.6V		32	45	μA
I <sub>standby</sub>	Standby Current	V <sub>IN</sub> =5.5V, V <sub>CE</sub> =0V		0	5	μA
I <sub>CEH</sub>	CE "H" Input Current	V <sub>IN</sub> =V <sub>CE</sub> =5.5V	-1	0	1	μA
I <sub>CEL</sub>	CE "L" Input Current	V <sub>IN</sub> =5.5V, V <sub>CE</sub> =0V	-1	0	1	μA
I <sub>VFBH</sub>	VFB "H" Input Current	V <sub>IN</sub> =V <sub>FB</sub> =5.5V, V <sub>CE</sub> =0V	-1	0	1	μA
I <sub>VFBL</sub>	VFB "L" Input Current	V <sub>IN</sub> =5.5V, V <sub>CE</sub> =V <sub>FB</sub> =0V	-1	0	1	μA
t <sub>dis</sub>	Auto Discharge Time <sup>(2)</sup>	V <sub>IN</sub> =2.3V, V <sub>CE</sub> =0V, C <sub>OUT</sub> =10μF		5	10	ms
I <sub>LXLEAKH</sub>	L <sub>X</sub> Leakage Current "H"	V <sub>IN</sub> =V <sub>LX</sub> =5.5V, V <sub>CE</sub> =0V	-1	0	5	μA
I <sub>LXLEAKL</sub>	L <sub>X</sub> Leakage Current "L"	V <sub>IN</sub> =5.5V, V <sub>CE</sub> =V <sub>LX</sub> =0V	-5	0	1	μA
V <sub>CEH</sub>	CE "H" Input Voltage	V <sub>IN</sub> =5.5V	1.0			V
V <sub>CEL</sub>	CE "L" Input Voltage	V <sub>IN</sub> =2.3V			0.4	V
R <sub>ONP</sub>	On Resistance of Pch Tr.	V <sub>IN</sub> =3.6V, I <sub>LX</sub> =-100mA		0.38		Ω
R <sub>ONN</sub>	On Resistance of Nch Tr.	V <sub>IN</sub> =3.6V, I <sub>LX</sub> =-100mA		0.3		Ω
Maxduty	Maximum Duty Cycle		100			%
t <sub>start</sub>	Soft-start Time	V <sub>IN</sub> =V <sub>CE</sub> =3.6V (V <sub>SET</sub> ≤2.6V), V <sub>IN</sub> =V <sub>CE</sub> =V <sub>SET</sub> +1V (V <sub>SET</sub> >2.6V)		150	300	μs
I <sub>LXLIM</sub>	L <sub>X</sub> Current Limit	V <sub>IN</sub> =V <sub>CE</sub> =3.6V (V <sub>SET</sub> ≤2.6V), V <sub>IN</sub> =V <sub>CE</sub> =V <sub>SET</sub> +1V (V <sub>SET</sub> >2.6V)	800	100 0		mA
V <sub>UVLO1</sub>	UVLO Detector Threshold	V <sub>IN</sub> =V <sub>CE</sub>	1.9	2.0	2.1	V
V <sub>UVLO2</sub>	UVLO Released Voltage	V <sub>IN</sub> =V <sub>CE</sub>	2.0	2.1	2.2	V
T <sub>TSD</sub>	Thermal Shutdown Temperature	Junction Temperature		140		°C
T <sub>TSR</sub>	Thermal Shutdown Released Temperature	Junction Temperature		100		°C

Note: Test circuit is "OPEN LOOP" and AGND=PGND=0V unless otherwise specified.

(1) V<sub>SET</sub>= Set Output Voltage

(2) It starts when the CE pin is low and ends when V<sub>OUT</sub> ≤ V<sub>SET</sub> x 0.1.

## THEORY OF OPERATION

### Operation of Step-Down DC/ DC Converter and Output Current

The step-down DC/ DC converter charges energy in the inductor when L<sub>x</sub> Tr. turns “ON”, and discharges the energy from the inductor when L<sub>x</sub> Tr. turns “OFF” and operates with less energy loss, so that a lower output voltage (V<sub>OUT</sub>) than the input voltage (V<sub>IN</sub>) can be obtained.

The operation of the step-down DC/ DC converter is explained in the following figures.

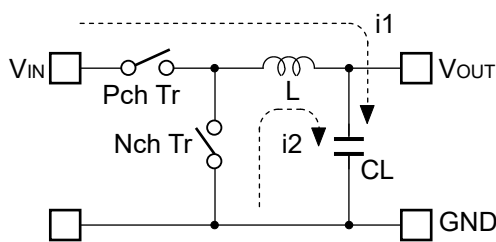

Figure 1. Basic Circuit

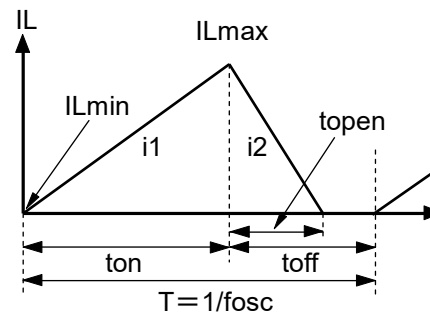

Figure 2. Inductor Current (IL) flowing through Inductor

- Step1.** Pch Tr. turns “ON” and IL (i1) flows, L is charged with energy. At this moment, i1 increases from the minimum inductor current (ILmin), which is 0A, and reaches the maximum inductor current (ILmax) in proportion to the on-time period (ton) of Pch Tr.
- Step2.** When Pch Tr. turns “OFF”, L tries to maintain IL at ILmax, so L turns Nch Tr. “ON” and IL (i2) flows into L.
- Step3.** i2 decreases gradually and reaches ILmin after the open-time period (topen) of Nch Tr., and then Nch Tr. turns “OFF”. This is called discontinuous current mode.  
As the output current (I<sub>OUT</sub>) increases, the off-time period (toff) of Pch Tr. runs out before IL reaches ILmin. The next cycle starts, and Pch Tr. turns “ON” and Nch Tr. turns “OFF”, which means IL starts increasing from ILmin. This is called continuous current mode.

In the case of PWM control system, V<sub>OUT</sub> is maintained by controlling ton. During PWM control, the oscillator frequency (fosc) is being maintained constant.

As shown in Figure 2. when the step-down DC/ DC operation is constant, ILmin and ILmax during ton of Pch Tr. would be same as during toff of Pch Tr.

The current differential between ILmax and ILmin is described as ΔI.

$$\Delta I = IL_{max} - IL_{min} = V_{OUT} \times topen / L = (V_{IN} - V_{OUT}) \times ton / L \dots \dots \dots \text{Equation 1}$$

However,

$$T = 1 / fosc = ton + toff$$

$$\text{Duty (\%)} = ton / T \times 100 = ton \times fosc \times 100$$

$$topen \leq toff$$

In Equation 1, " $V_{OUT} \times t_{open} / L$ " shows the amount of current change in "OFF" state. Also, " $(V_{IN} - V_{OUT}) \times t_{on} / L$ " shows the amount of current change at "ON" state.

**Discontinuous Mode and Continuous Mode**

As illustrated in Figure 3., when  $I_{OUT}$  is relatively small,  $t_{open} < t_{off}$ . In this case, the energy charged into L during  $t_{on}$  will be completely discharged during  $t_{off}$ , as a result,  $I_{Lmin} = 0$ . This is called discontinuous mode.

When  $I_{OUT}$  is gradually increased, eventually  $t_{open} = t_{off}$  and when  $I_{OUT}$  is increased further, eventually  $I_{Lmin} > 0$ . This is called continuous mode.

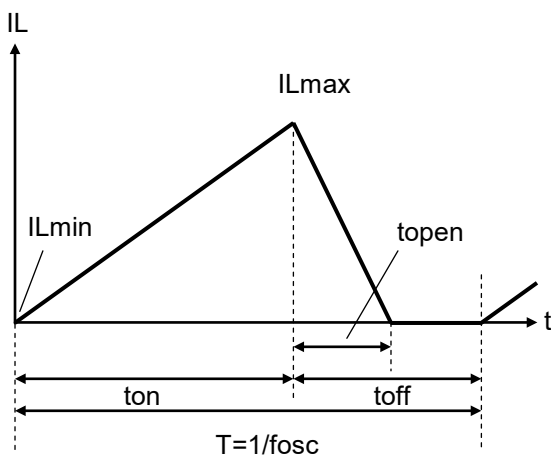

Figure 3. Discontinuous Mode

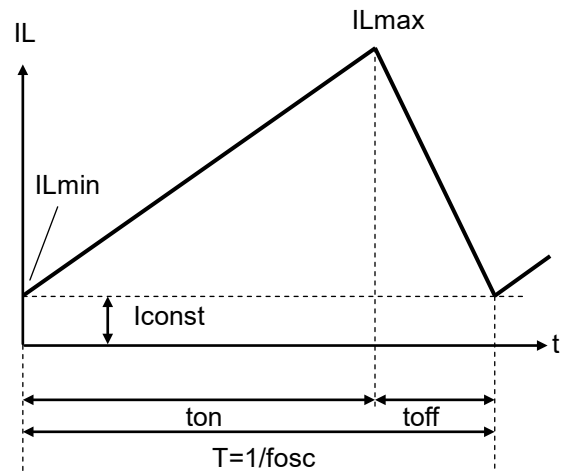

Figure 4. Continuous Mode

In the continuous mode, the solution of Equation 1 is described as  $t_{onc}$ .

$$t_{onc} = T \times V_{OUT} / V_{IN} \dots\dots\dots \text{Equation 2}$$

When  $t_{on} < t_{onc}$ , it is discontinuous mode, and when  $t_{on} = t_{onc}$ , it is continuous mode.

**VFM Mode**

In low output current, the IC automatically switches into VFM mode in order to achieve high efficiency. In VFM mode,  $t_{on}$  is forced to end when the inductor current reaches the pre-set  $I_{Lmax}$ . In the VFM mode,  $I_{Lmax}$  is typically set to 180mA. When  $t_{on}$  reaches 1.5 times of  $T=1/f_{osc}$ ,  $t_{on}$  will be forced to end even if the inductor current is not reached  $I_{Lmax}$ .

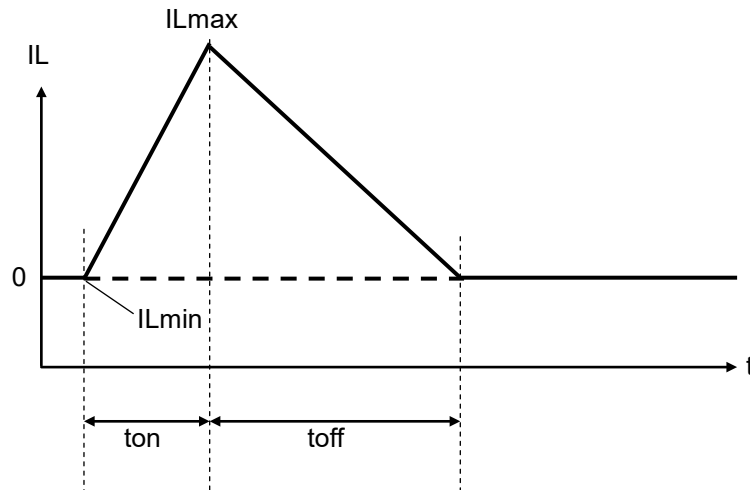
**Figure 5. VFM Mode**



**Output Current and Selection of External Components**

The following equations explain the relationship between output current and peripheral components used in the diagrams in "TYPICAL APPLICATIONS".

Ripple Current P-P value is described as  $I_{RP}$ , ON resistance of Pch Tr. is described as  $R_{ONP}$ , ON resistance of Nch Tr. is described as  $R_{ONN}$ , and DC resistor of the inductor is described as  $R_L$ .

First, when Pch Tr. is "ON", the following equation is satisfied.

$$V_{IN} = V_{OUT} + (R_{ONP} + R_L) \times I_{OUT} + L \times I_{RP} / t_{on} \dots \dots \dots \text{Equation 3}$$

Second, when Pch Tr. is "OFF" (Nch Tr. is "ON"), the following equation is satisfied.

$$L \times I_{RP} / t_{off} = R_{ONN} \times I_{OUT} + V_{OUT} + R_L \times I_{OUT} \dots \dots \dots \text{Equation 4}$$

Put Equation 4 into Equation 3 to solve ON duty of Pch Tr. ( $D_{ON} = t_{on} / (t_{off} + t_{on})$ ):

$$D_{ON} = (V_{OUT} + R_{ONN} \times I_{OUT} + R_L \times I_{OUT}) / (V_{IN} + R_{ONN} \times I_{OUT} - R_{ONP} \times I_{OUT}) \dots \dots \dots \text{Equation 5}$$

Ripple Current is described as follows:

$$I_{RP} = (V_{IN} - V_{OUT} - R_{ONP} \times I_{OUT} - R_L \times I_{OUT}) \times D_{ON} / f_{osc} / L \dots \dots \dots \text{Equation 6}$$

Peak current that flows through L, and Lx Tr. is described as follows:

$$I_{Lxmax} = I_{OUT} + I_{RP} / 2 \dots \dots \dots \text{Equation 7}$$

- ★ Please consider  $I_{LxMAX}$  when setting conditions of input and output, as well as selecting the external components.
- ★ The above calculation formulas are based on the ideal operation of the ICs in continuous mode.

**Timing Chart**

**(1) Soft-start Time**

**Starting-up with CE Pin**

The IC starts to operate when the CE pin voltage ( $V_{CE}$ ) exceeds the threshold voltage. The threshold voltage is preset between CE "H" input voltage ( $V_{CEH}$ ) and CE "L" input voltage ( $V_{CEL}$ ).

After the start-up of the IC, soft-start circuit starts to operate. Then, after a certain period of time, the reference voltage ( $V_{REF}$ ) in the IC gradually increases up to the specified value.

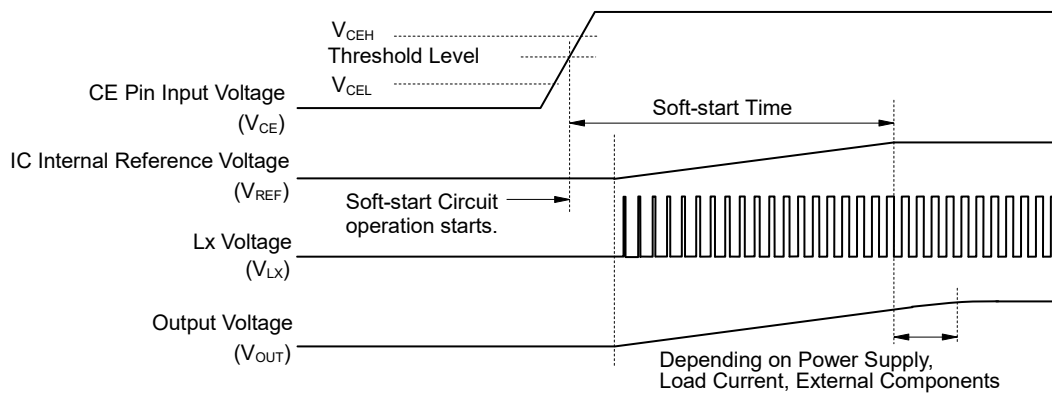

Soft-start time starts when soft-start circuit is activated, and ends when the reference voltage reaches the specified voltage.

- ★ Soft start time is not always equal to the turn-on speed of the step-down DC/ DC converter. Please note that the turn-on speed could be affected by the power supply capacity, the output current, the inductance value and the  $C_{OUT}$  value.

**Starting-up with Power Supply**

After the power-on, when  $V_{IN}$  exceeds the UVLO released voltage ( $V_{UVLO2}$ ), the IC starts to operate. Then, soft-start circuit starts to operate and after a certain period of time,  $V_{REF}$  gradually increases up to the specified value. Soft-start time starts when soft-start circuit is activated, and ends when  $V_{REF}$  reaches the specified value.

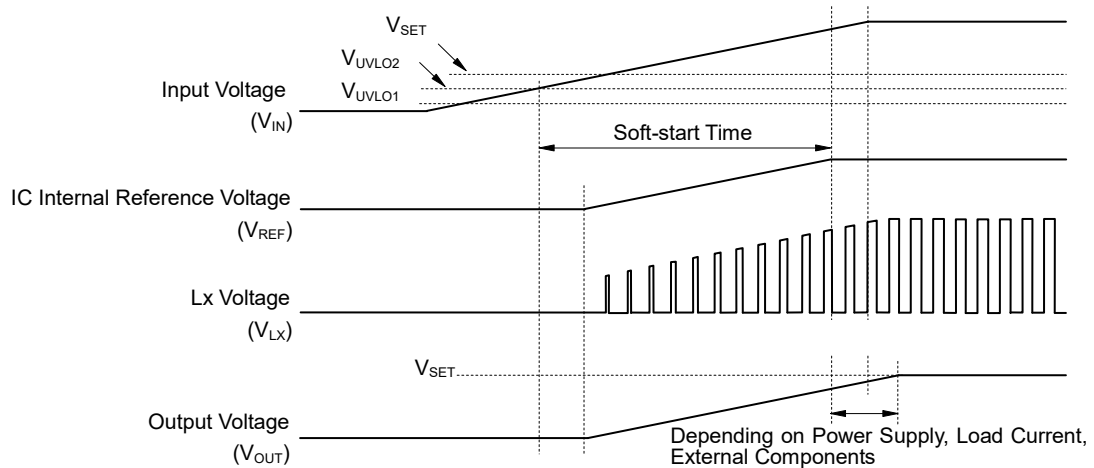

- ★ Please note that the turn-on speed of  $V_{OUT}$  could be affected by the power supply capacity, the output current, the inductance value, the  $C_{OUT}$  value and the turn-on speed of  $V_{IN}$  determined by  $C_{IN}$ .

**(2) Under Voltage Lockout (UVLO) Circuit**

If  $V_{IN}$  becomes lower than  $V_{SET}$ , the step-down DC/ DC converter stops the switching operation and ON duty becomes 100%, and then  $V_{OUT}$  gradually drops according to  $V_{IN}$ .

If the  $V_{IN}$  drops more and becomes lower than the UVLO detector threshold ( $V_{UVLO1}$ ), the UVLO circuit starts to operate,  $V_{REF}$  stops, and Pch and Nch built-in switch transistors turn “OFF”. As a result,  $V_{OUT}$  drops according to the  $C_{OUT}$  capacitance value and the load.

To restart the operation,  $V_{IN}$  needs to be higher than  $V_{UVLO2}$ . The timing chart below shows the voltage shifts of  $V_{REF}$ ,  $V_{LX}$  and  $V_{OUT}$  when  $V_{IN}$  value is varied.

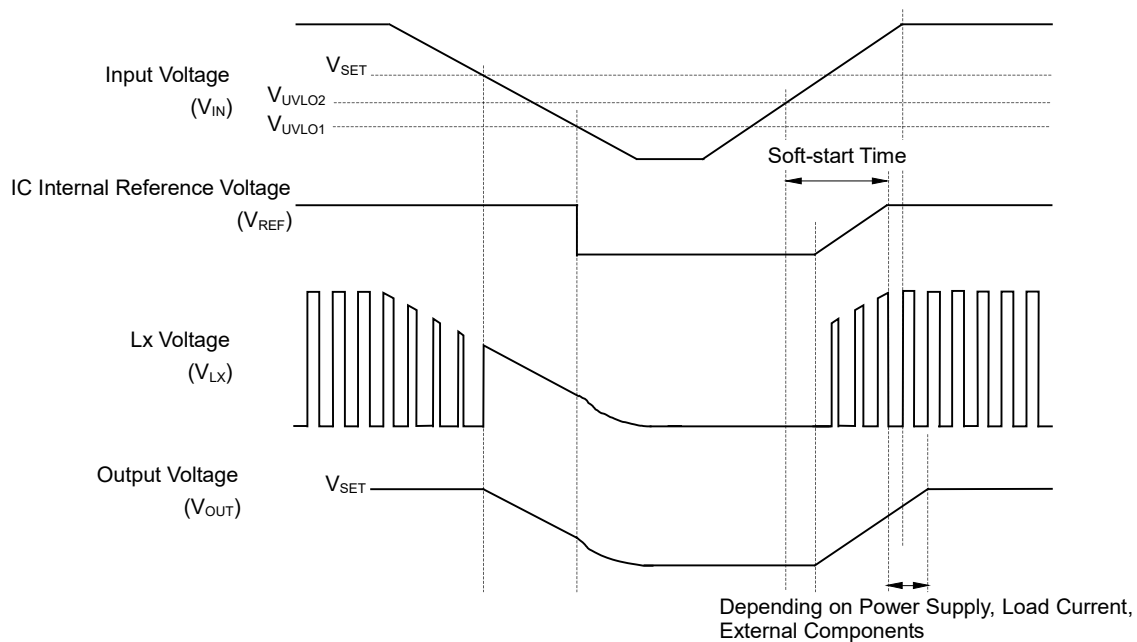

- ★ Falling edge (operating) and rising edge (releasing) waveforms of  $V_{OUT}$  could be affected by the initial voltage of  $C_{OUT}$  and the output current of  $V_{OUT}$ .

**(3) Over Current Protection Circuit**

Over current protection circuit supervises the inductor peak current (the peak current flowing through Pch Tr.) in each switching cycle, and if the current exceeds the  $L_x$  current limit ( $I_{LXLIM}$ ), it turns off Pch Tr.  $I_{LXLIM}$  of the RP507K001B is set to Typ.1000mA.

**Notes:**  $I_{LXLIM}$  could be easily affected by self-heating or ambient environment. If the  $V_{IN}$  drops dramatically or becomes unstable due to short-circuit, protection operation could be affected.

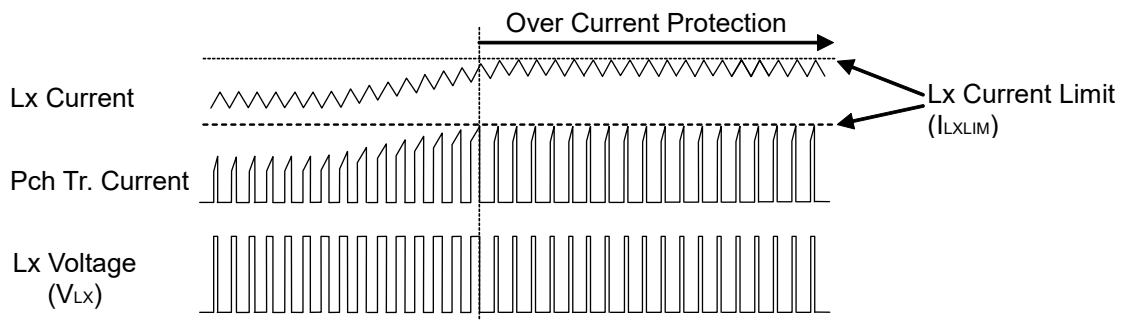

## APPLICATION INFORMATION

### Typical Application

(Adjustable Output Voltage Type)

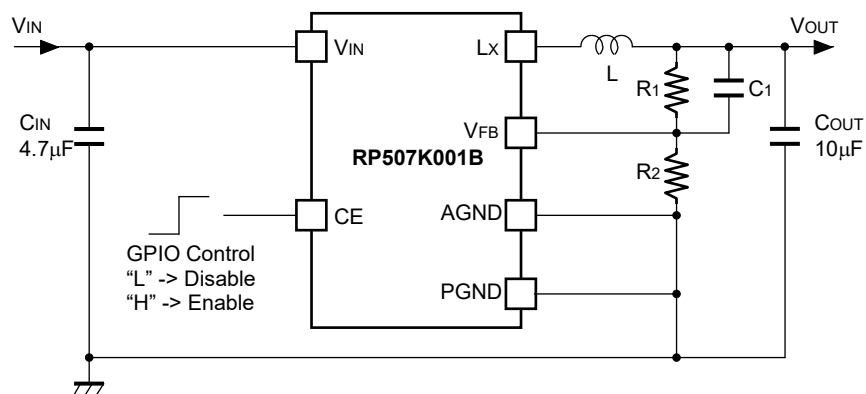
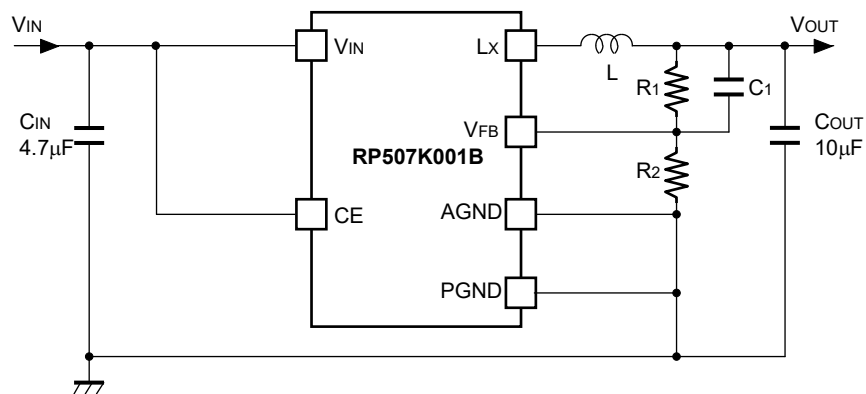
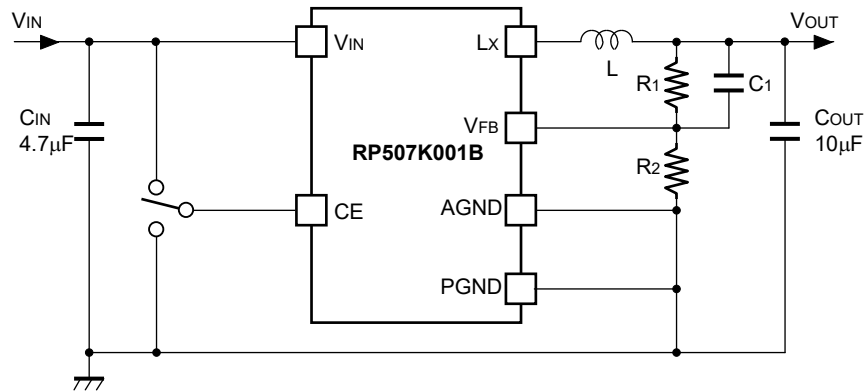

**Table 1. Recommended Components**

<b>Symbol</b>	<b>Value</b>	<b>Components</b>	<b>Part Number</b>
C <sub>IN</sub>	4.7 $\mu$ F	Ceramic Capacitor	C1005X5R0J475M (TDK) JMK105BBJ475MV (Taiyo Yuden) GRM155R60J475ME47 (Murata)
C <sub>OUT</sub>	10 $\mu$ F	Ceramic Capacitor	GRM155R60J106ME44 (Murata) JMK105CBJ106MV (Taiyo Yuden)
L	2.2 $\mu$ H	Inductor	LQM21PN2R2NGC (Murata) CIG21L2R2MNE (Samsung Electro-Mechanics) MIPSZ2012D2R2 (FDK)
	4.7 $\mu$ H		CIG21L4R7MNE (Samsung Electro-Mechanics) MIPS2520D4R7 (FDK)

## TECHNICAL NOTES

When using the RP507K001B, please consider the following points.

- AGND and PGND must be wired to the GND plane when mounting on boards.
- Ensure the  $V_{IN}$  and AGND/ PGND lines are sufficiently robust. A large switching current flows through the AGND/ PGND lines, the  $V_{DD}$  line, the  $V_{OUT}$  line, an inductor, and  $L_X$ . If their impedance is too high, noise pickup or unstable operation may result. Set the external components as close as possible to the IC and minimize the wiring between the components and the IC, especially between a capacitor ( $C_{IN}$ ) and the  $V_{IN}$  pin. The wiring between a resistor for setting output voltage ( $R_1$ ) and an inductor (L) and between L and Load should be separated.
- Choose a low ESR ceramic capacitor. The capacitance of  $C_{IN}$  should be more than or equal to 4.7 $\mu$ F. The capacitance of a capacitor ( $C_{OUT}$ ) should be 10 $\mu$ F.
- The Inductance value should be set within the range of 1.5 $\mu$ H to 4.7 $\mu$ H. However, the inductance value is limited by output voltage, so please refer to the table below. The phase compensation of this IC is designed according to the  $C_{OUT}$  and L values. Choose an inductor that has small DC resistance, has enough allowable current and is hard to cause magnetic saturation. If the inductance value of an inductor is extremely small, the peak current of  $L_X$  may increase. The increased  $L_X$  peak current reaches " $L_X$  limit current" to trigger over current protection circuit even if the load current is less than 600mA.

**Table 2. Set Output Voltage Range vs. Inductance Range**

Set Output Voltage (V)	Inductance		
	L=1.5 $\mu$ H	L=2.2 $\mu$ H	L=4.7 $\mu$ H
$V_{SET}$ 0.7~1.0	Ok	Good	-
1.1~1.7	-	Good	-
1.8~2.5	-	Good	Ok
2.6~	-	Ok	Good

- Over current protection circuit may be affected by self-heating or power dissipation environment.
- The output voltage ( $V_{OUT}$ ) is adjustable by changing the  $R_1$  and  $R_2$  values as follows.

$$V_{OUT} = V_{FB} \times (R_1 + R_2) / R_2 \quad (0.7V \leq V_{OUT} \leq 5.5V)$$



- The recommended resistance values for R<sub>1</sub>, R<sub>2</sub> and C<sub>1</sub> are as follows.

Table 3. Set Output Voltage Range vs. Resistor & Capacitor Range

Set Output Voltage (V)	Resistor (kΩ)		Capacitor (pF)
	R <sub>1</sub>	R <sub>2</sub>	C <sub>1</sub>
V <sub>SET</sub>			
1.0	120	180	22
1.2	180	180	22
1.5	270	180	22
1.8	240	120	22
2.5	380	120	15
2.8	275	75	15
3.3	270	60	15

- The performance of power source circuits using this IC largely depends on the peripheral circuits. When selecting the peripheral components, please consider the conditions of use. Do not allow each component, PCB pattern and the IC to exceed their respected rated values (voltage, current, and power) when designing the peripheral circuits.

### Reference PCB Layout

#### RP507K001B (PKG: DFN(PL)1616-6D) PCB Layout

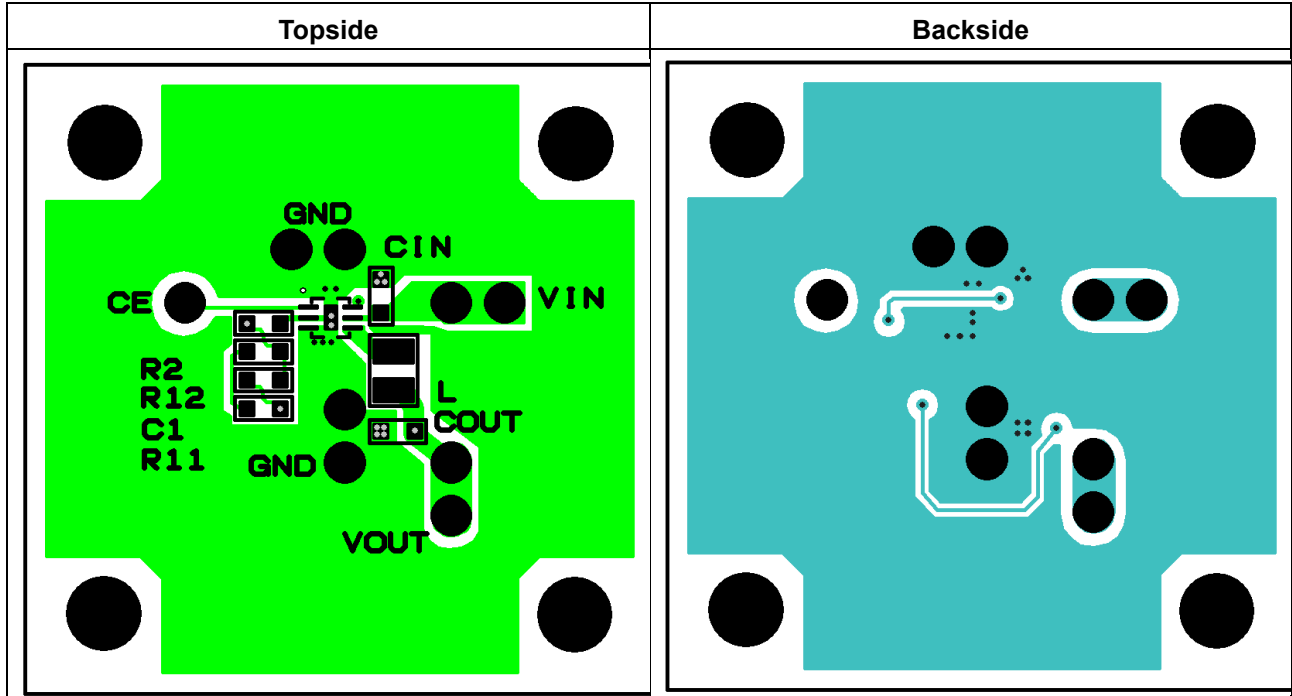

\* R11 and R12 are arranged as a substitute for R1 so that two resistors can be connected in series.

## TYPICAL CHARACTERISTICS

### 1) Output Voltage vs. Output Current

RP507K001B  $V_{out}=1.0V$

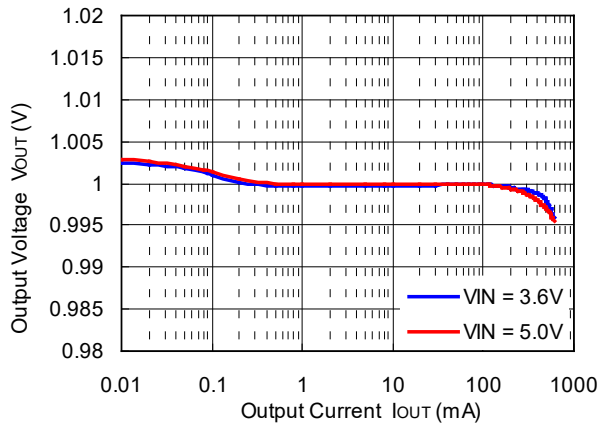

RP507K001B  $V_{out}=1.2V$

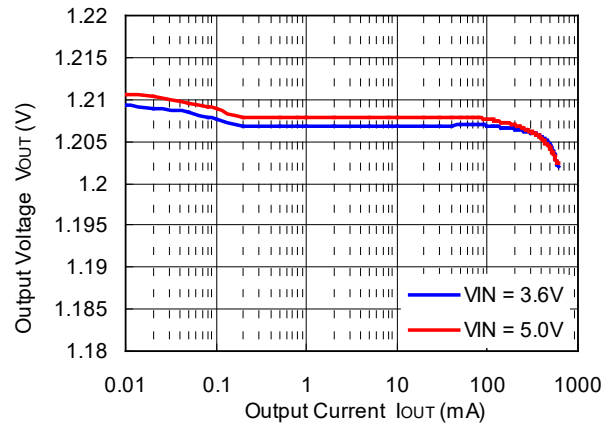

RP507K001B  $V_{out}=1.8V$

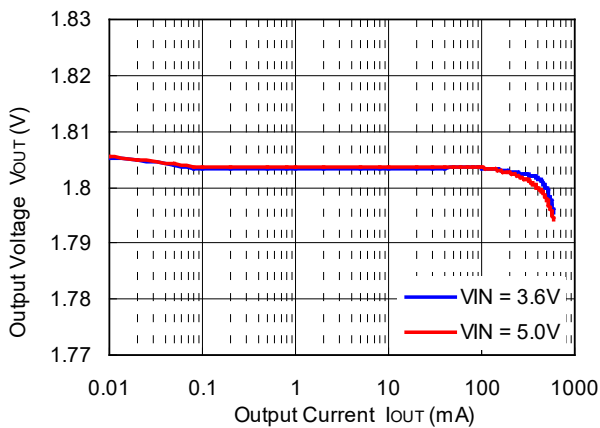

RP507K001B  $V_{out}=3.3V$

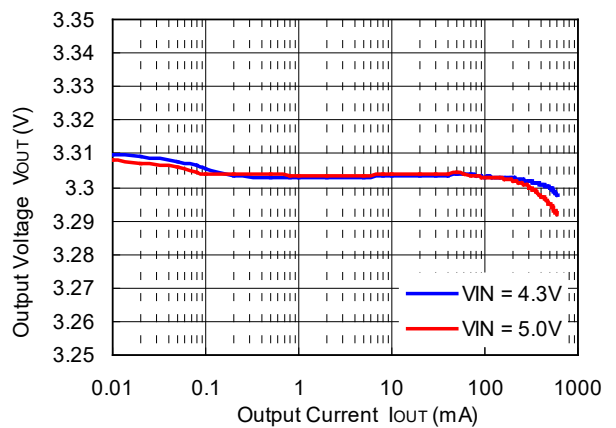

### 2) Output Voltage vs. Input Voltage

RP507K001B  $V_{out}=1.0V$

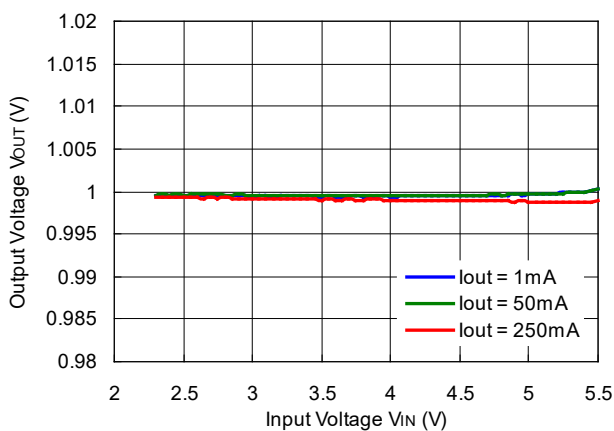

RP507K001B  $V_{out}=1.2V$

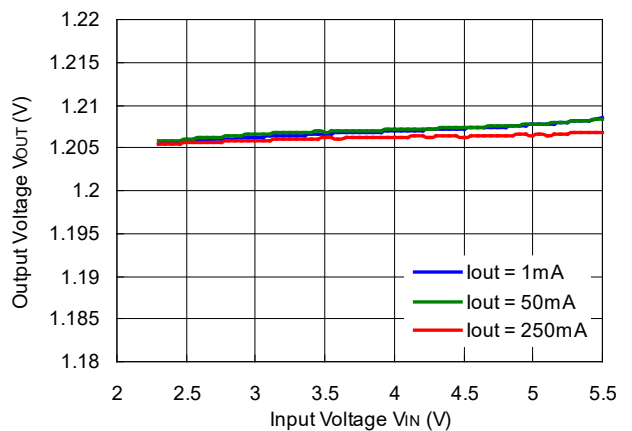

RP507K001B  $V_{OUT}=1.8V$

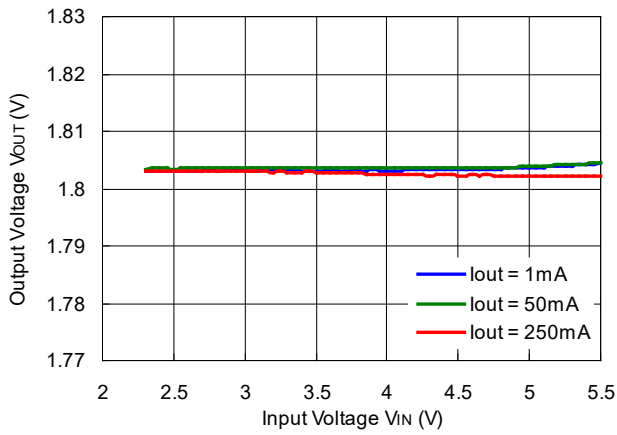

RP507K001B  $V_{OUT}=3.3V$

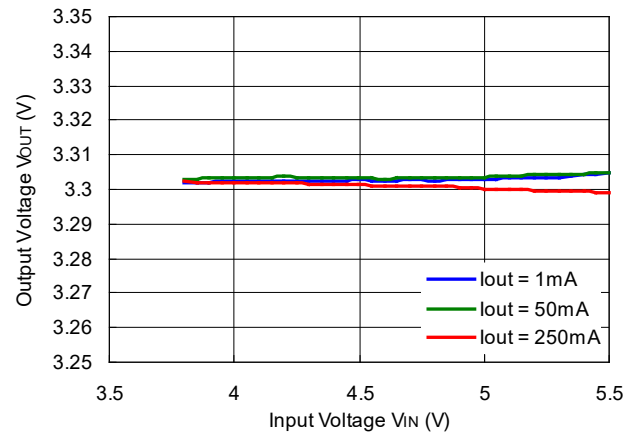

3) Feedback Voltage vs. Temperature

RP507K001B

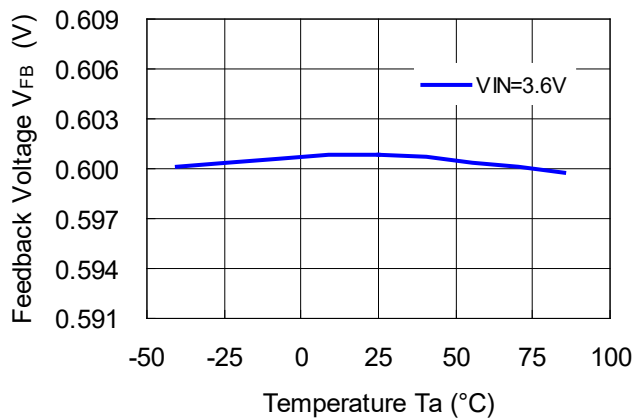

4) Efficiency vs. Output Current

RP507K001B  $V_{OUT}=1.0V$   
L=2.2 $\mu$ H (MIPSZ2012D2R2)

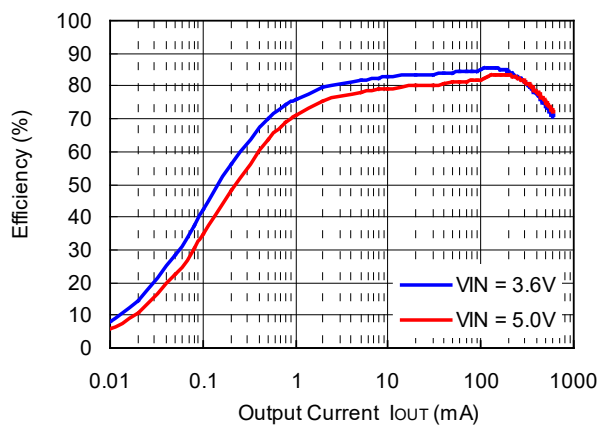

RP507K001B  $V_{OUT}=1.2V$   
L=2.2 $\mu$ H (MIPSZ2012D2R2)

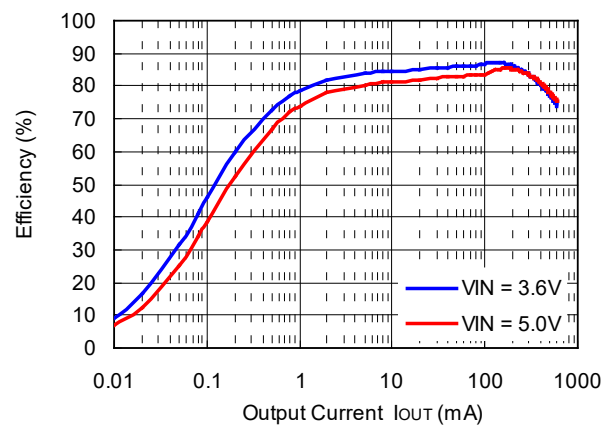

RP507K001B  $V_{OUT}=1.8V$   
L=2.2 $\mu$ H (MIPSZ2012D2R2)

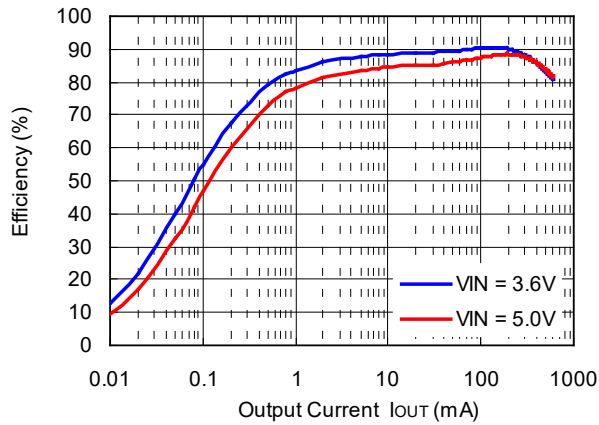

RP507K001B  $V_{OUT}=3.3V$   
L=4.7 $\mu$ H (MIPS2520D4R7)

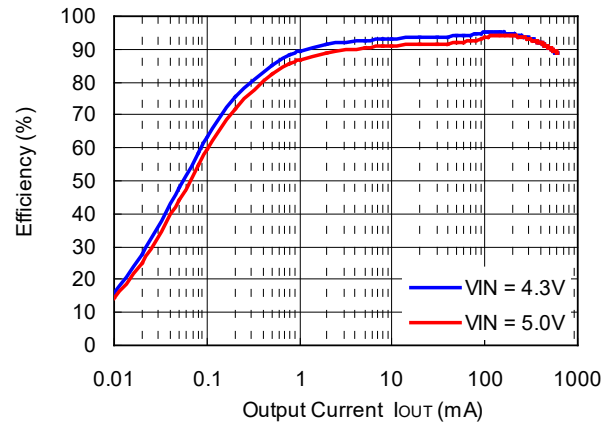

5) Supply Current vs. Temperature

RP507K001B  $V_{OUT}=1.8V$  ( $V_{IN}=3.6V$ )

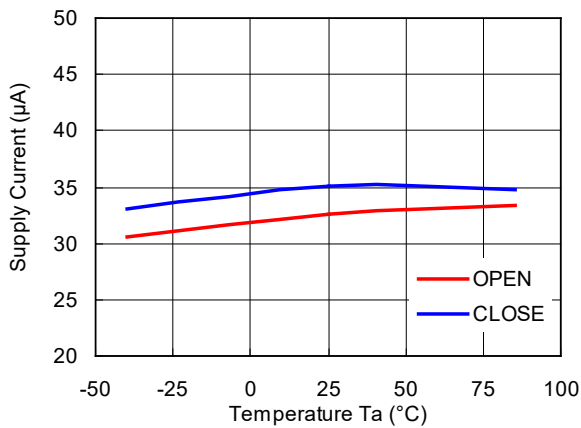

6) Supply Current vs. Input Voltage

RP507K001B  $V_{OUT}=1.8V$

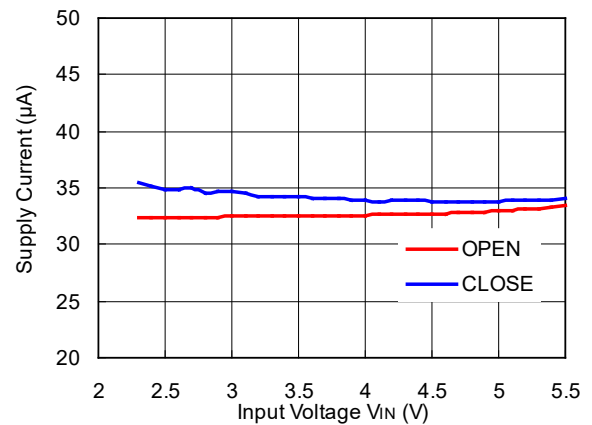

7) DC/DC Output Waveform

RP507K001B  $V_{OUT}=1.0V$  ( $V_{IN}=3.6V$ )

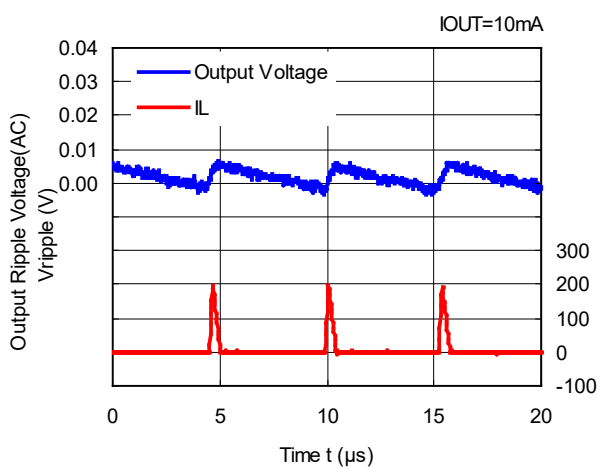

RP507K001B  $V_{OUT}=1.0V$  ( $V_{IN}=3.6V$ )

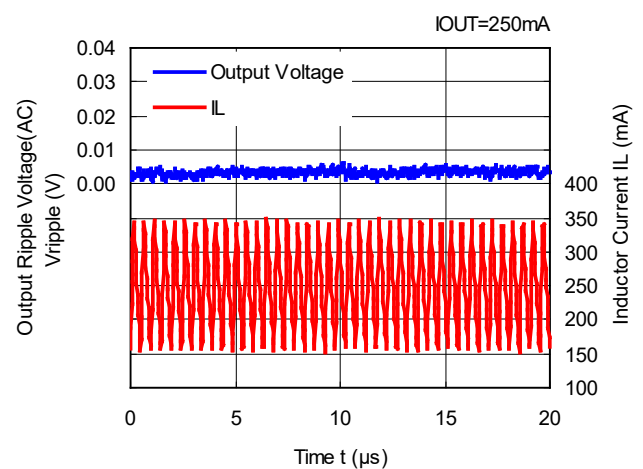

**RP507K001B  $V_{OUT}=1.2V$  ( $V_{IN}=3.6V$ )**

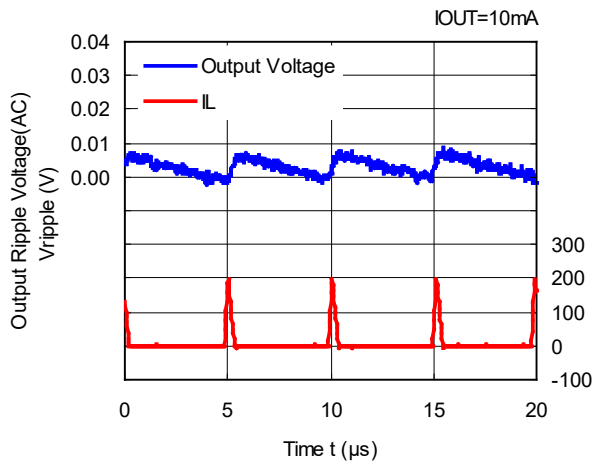

**RP507K001B  $V_{OUT}=1.2V$  ( $V_{IN}=3.6V$ )**

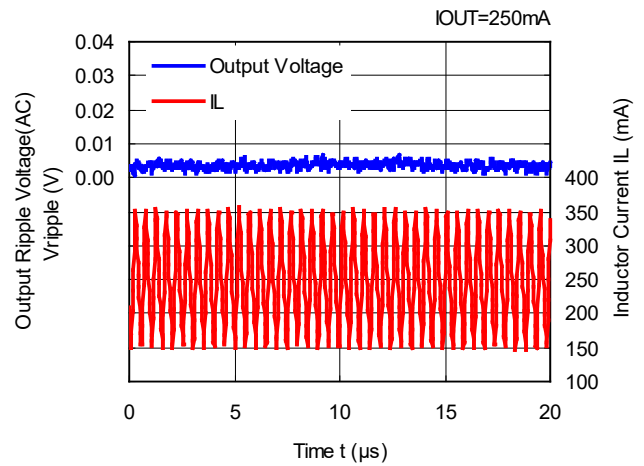

**RP507K001B  $V_{OUT}=1.8V$  ( $V_{IN}=3.6V$ )**

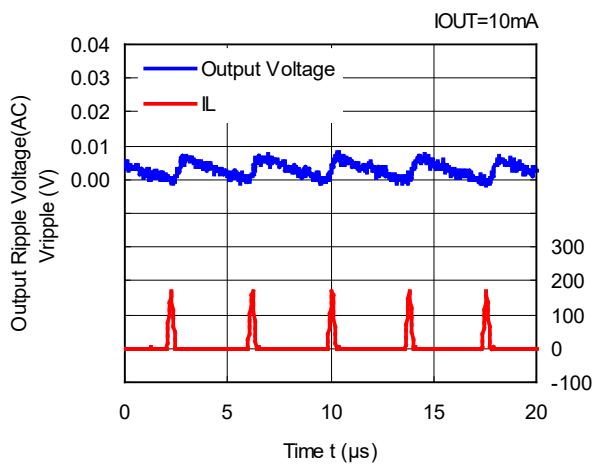

**RP507K001B  $V_{OUT}=1.8V$  ( $V_{IN}=3.6V$ )**

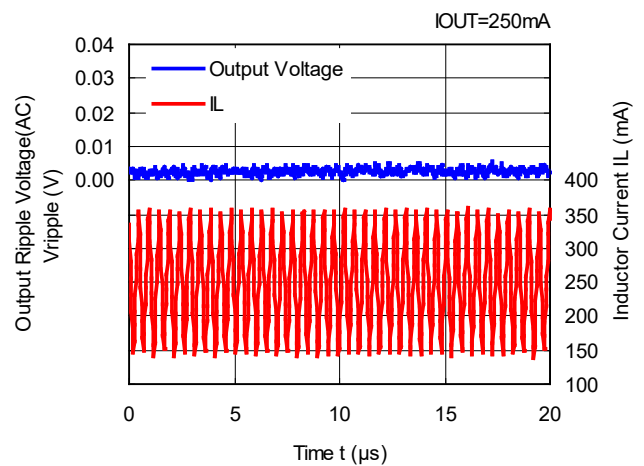

**RP507K001B  $V_{OUT}=3.3V$  ( $V_{IN}=4.3V$ )**

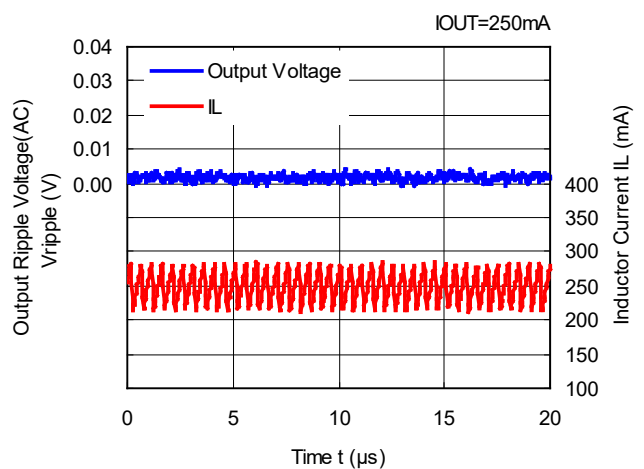
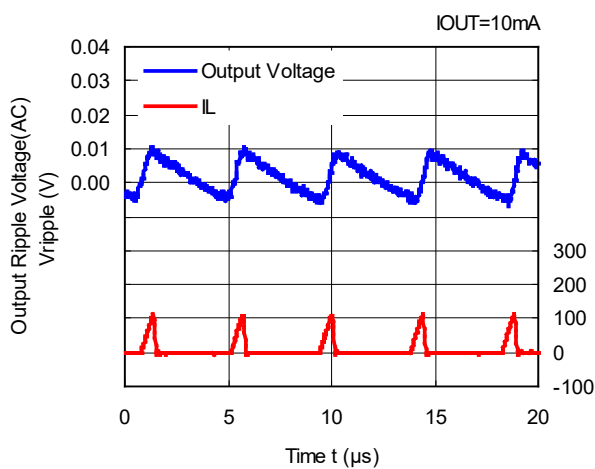

8) Oscillator Frequency vs. Temperature

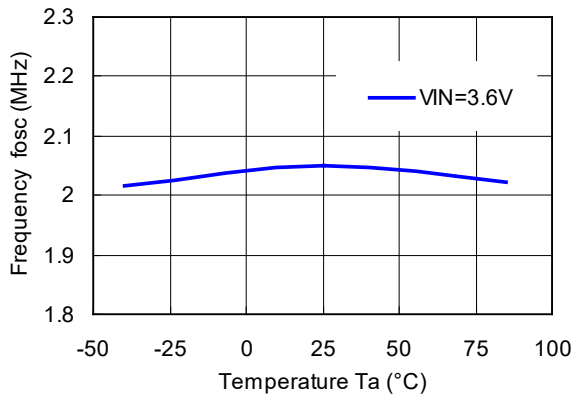

9) Oscillator Frequency vs. Input Voltage

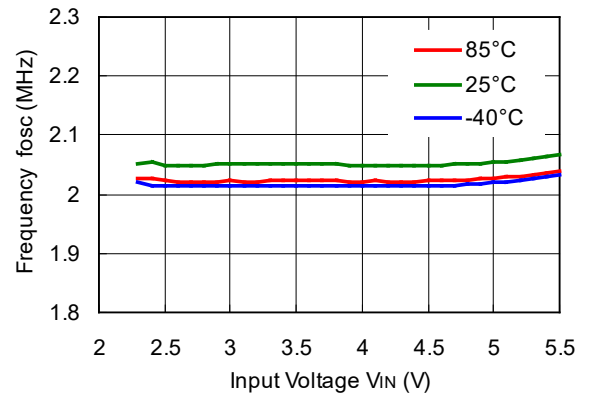

10) Soft-start Time vs. Temperature

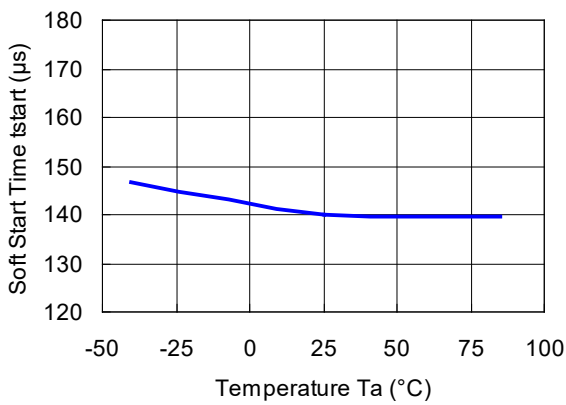

11) UVLO Detector Threshold / Released Voltage vs. Temperature

UVLO Detector Threshold

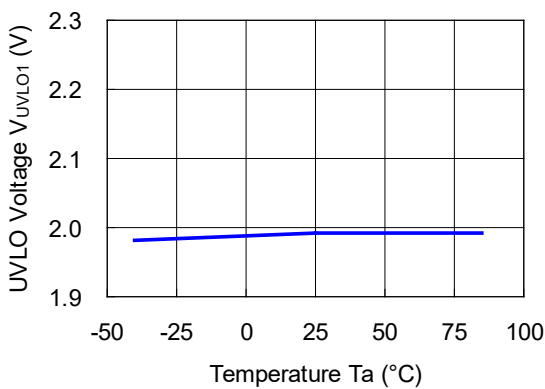

UVLO Released Voltage

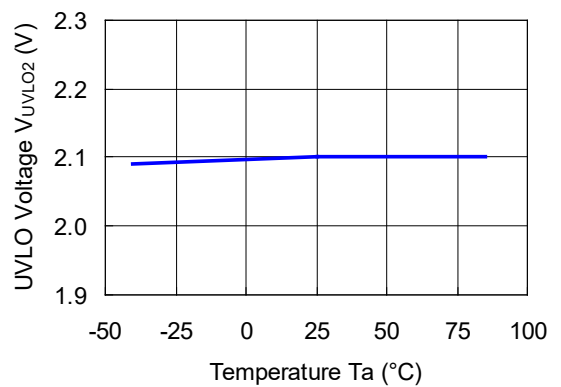

12) CE Input Voltage vs. Temperature

CE“H” Input Voltage( $V_{IN}=5.5V$ )

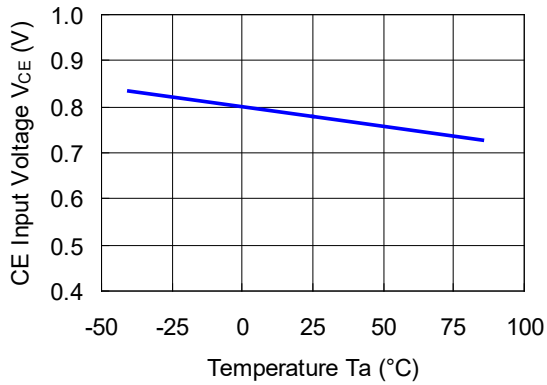

CE“L” Input Voltage ( $V_{IN}=2.3V$ )

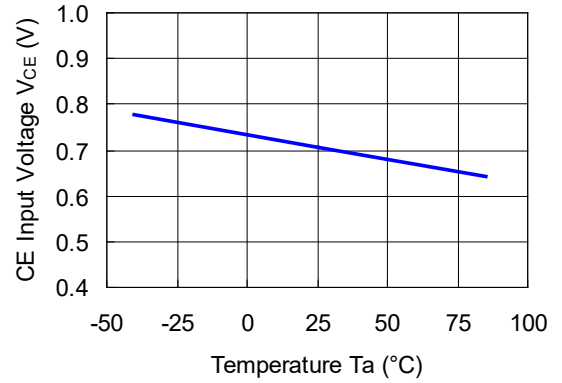

13) Lx Current Limit vs. Temperature

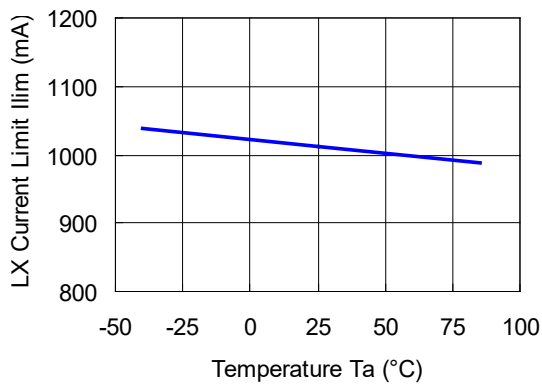

14) On Resistance of Pch Tr. vs. Temperature

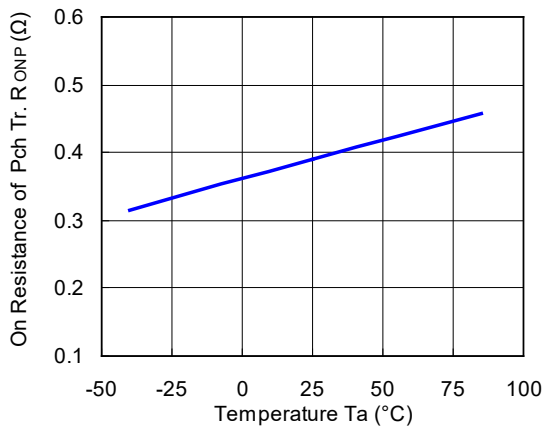

15) On Resistance of Nch Tr. vs. Temperature

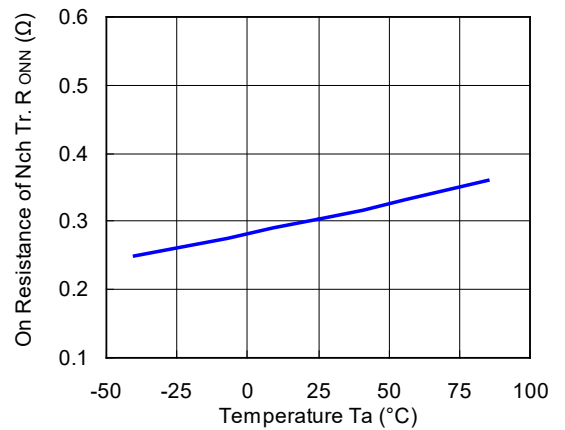

16) Load Transient Response ( $C_{OUT}=10\mu F$  GRM155R60J106ME44)

RP507K001B ( $V_{IN}=3.6V$ ,  $V_{OUT}=1.0V$ )

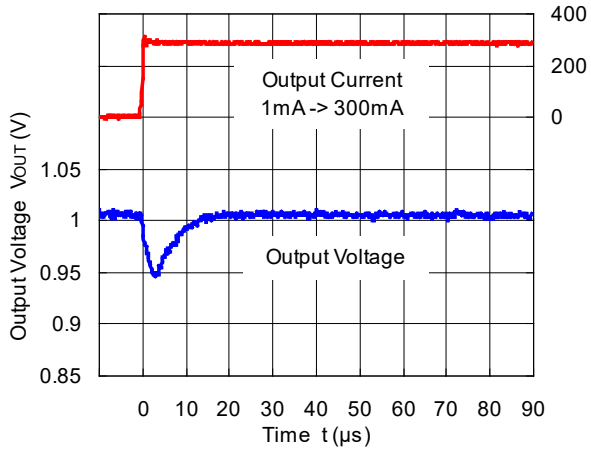

RP507K001B ( $V_{IN}=3.6V$ ,  $V_{OUT}=1.0V$ )

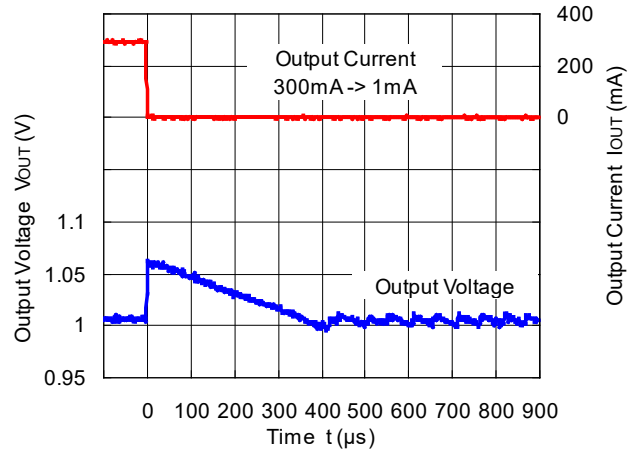

RP507K001B ( $V_{IN}=3.6V$ ,  $V_{OUT}=1.0V$ )

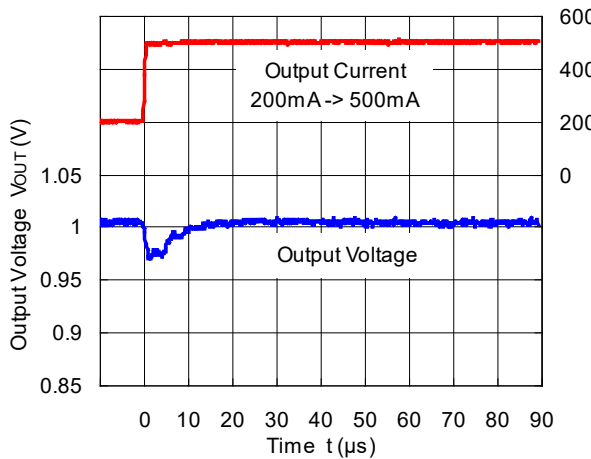

RP507K001B ( $V_{IN}=3.6V$ ,  $V_{OUT}=1.0V$ )

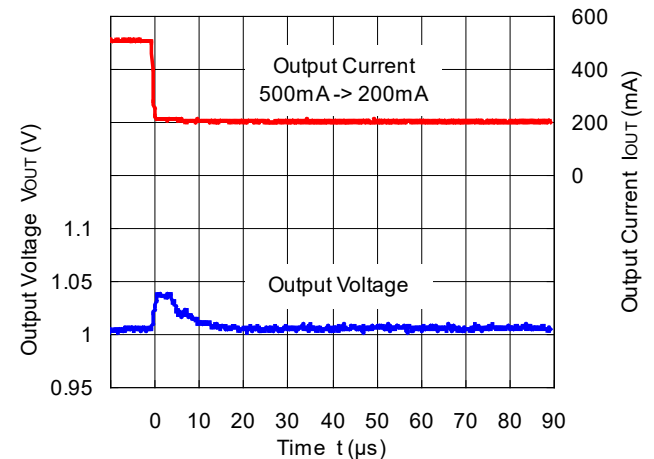

RP507K001B ( $V_{IN}=3.6V$ ,  $V_{OUT}=1.2V$ )

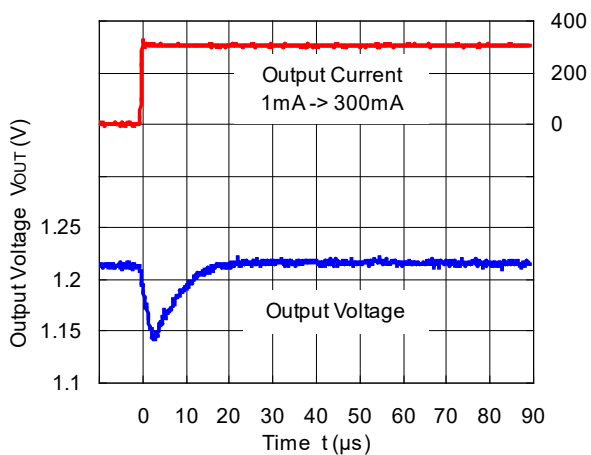

RP507K001B ( $V_{IN}=3.6V$ ,  $V_{OUT}=1.2V$ )

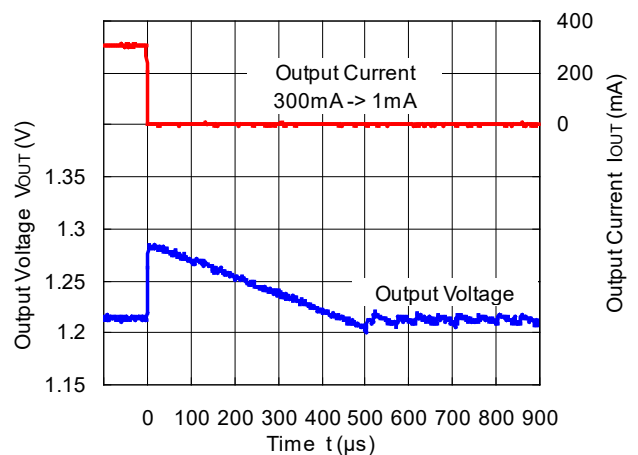



**RP507K001B (V<sub>IN</sub>=3.6V, V<sub>OUT</sub>=1.2V)**

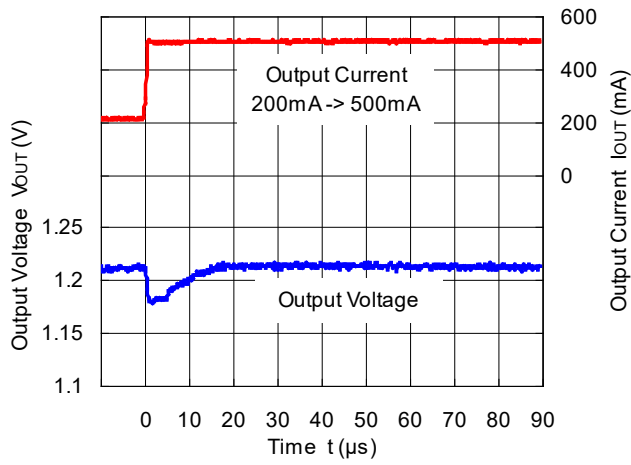

**RP507K001B (V<sub>IN</sub>=3.6V, V<sub>OUT</sub>=1.2V)**

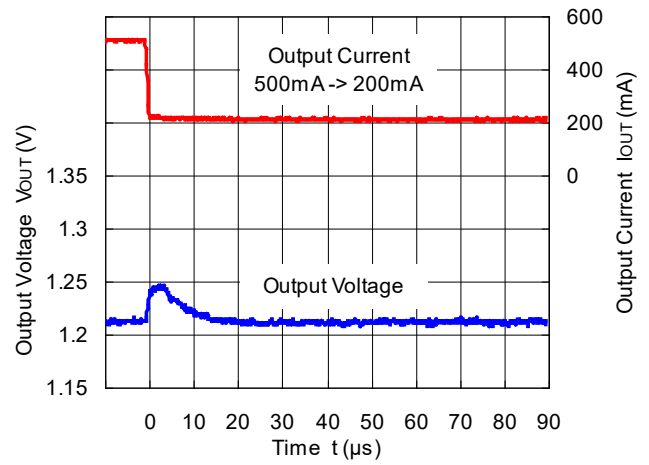

**RP507K001B (V<sub>IN</sub>=3.6V, V<sub>OUT</sub>=1.8V)**

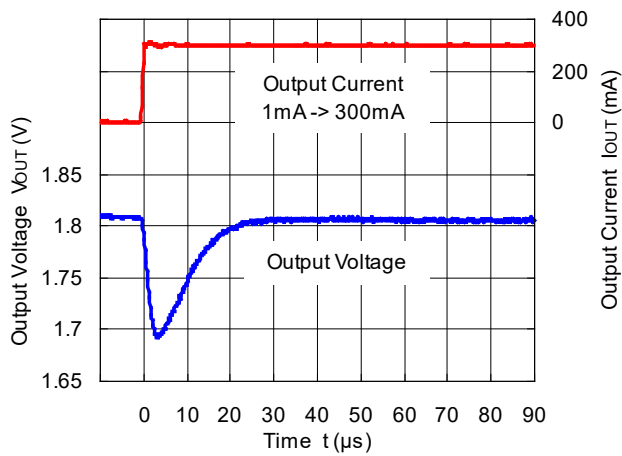

**RP507K001B (V<sub>IN</sub>=3.6V, V<sub>OUT</sub>=1.8V)**

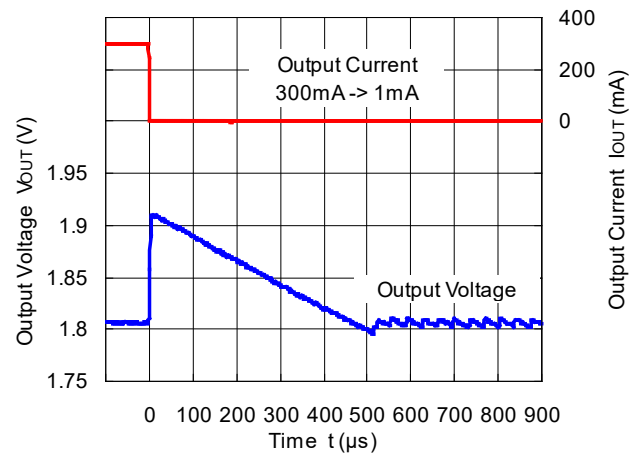

**RP507K001B (V<sub>IN</sub>=3.6V, V<sub>OUT</sub>=1.8V)**

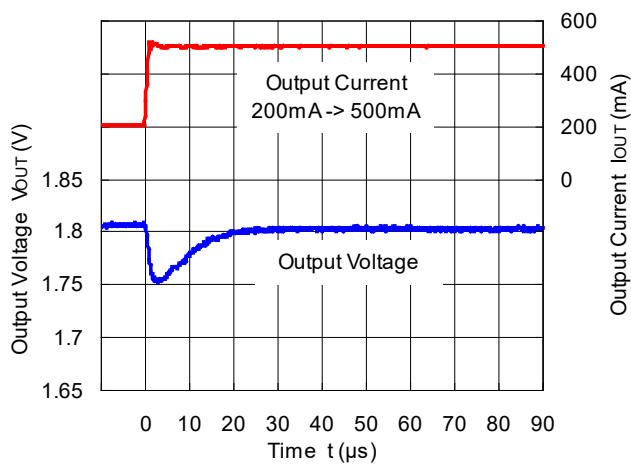

**RP507K001B (V<sub>IN</sub>=3.6V, V<sub>OUT</sub>=1.8V)**

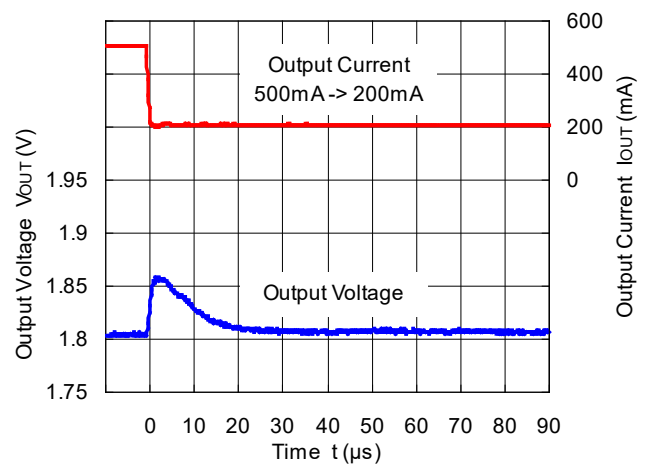

RP507K001B ( $V_{IN}=5.0V$ ,  $V_{OUT}=3.3V$ )

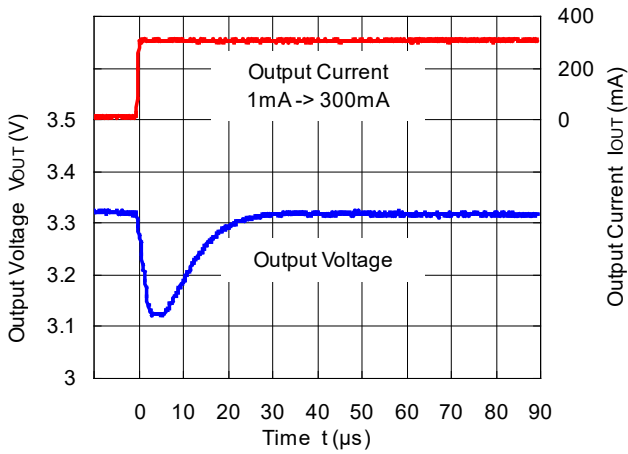

RP507K001B ( $V_{IN}=5.0V$ ,  $V_{OUT}=3.3V$ )

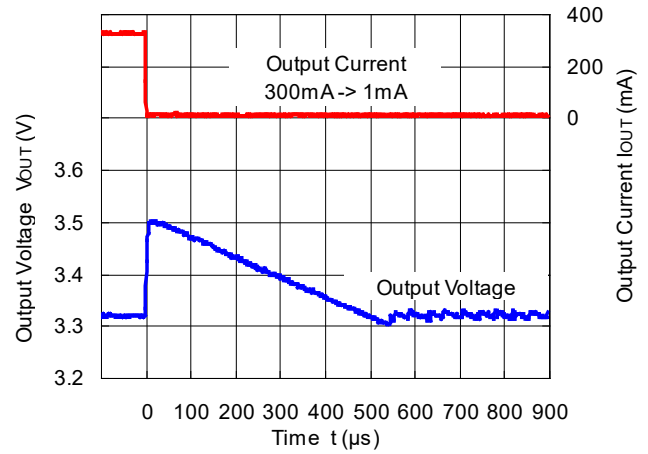

RP507K001B ( $V_{IN}=5.0V$ ,  $V_{OUT}=3.3V$ )

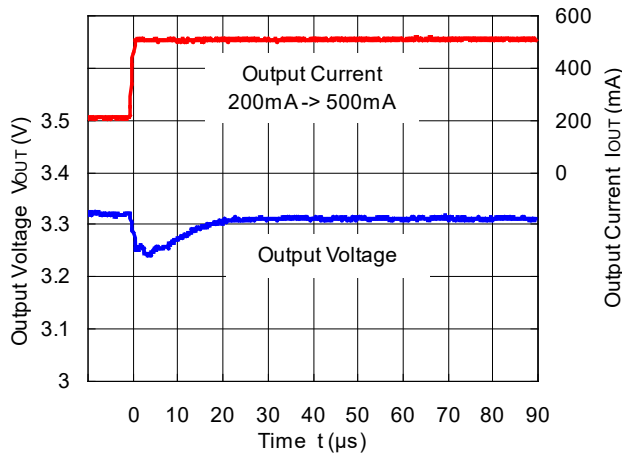

RP507K001B ( $V_{IN}=5.0V$ ,  $V_{OUT}=3.3V$ )

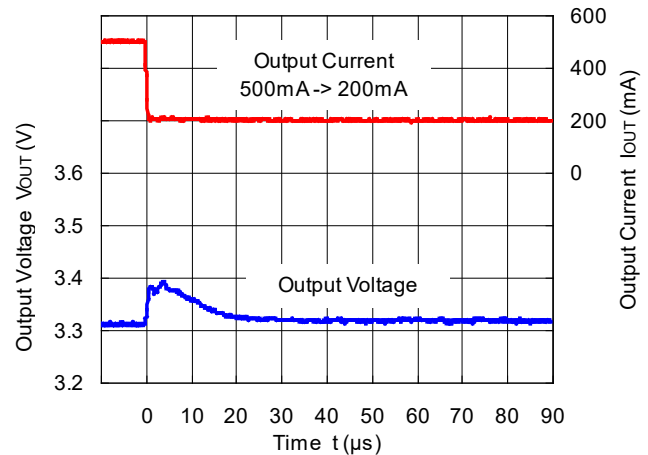

# POWER DISSIPATION

# DFN(PL)1616-6D

PD-DFN(PL)1616-6D-(85125)-JE-B

The power dissipation of the package is dependent on PCB material, layout, and environmental conditions. The following measurement conditions are based on JEDEC STD. 51.

## Measurement Conditions

Item	Measurement Conditions
Environment	Mounting on Board (Wind Velocity = 0 m/s)
Board Material	Glass Cloth Epoxy Plastic (Four-Layer Board)
Board Dimensions	76.2 mm × 114.3 mm × 0.8 mm
Copper Ratio	Outer Layer (First Layer): Less than 95% of 50 mm Square Inner Layers (Second and Third Layers): Approx. 100% of 50 mm Square Outer Layer (Fourth Layer): Approx. 100% of 50 mm Square
Through-holes	φ 0.2 mm × 25 pcs

## Measurement Result

(Ta = 25°C, Tjmax = 125°C)

Item	Measurement Result
Power Dissipation	1580 mW
Thermal Resistance ( $\theta_{ja}$ )	$\theta_{ja} = 63^\circ\text{C/W}$
Thermal Characterization Parameter ( $\psi_{jt}$ )	$\psi_{jt} = 33^\circ\text{C/W}$

$\theta_{ja}$ : Junction-to-Ambient Thermal Resistance

$\psi_{jt}$ : Junction-to-Top Thermal Characterization Parameter

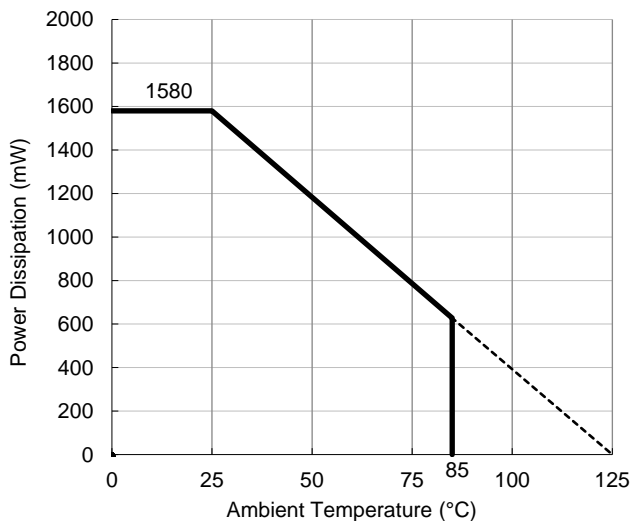

Power Dissipation vs. Ambient Temperature

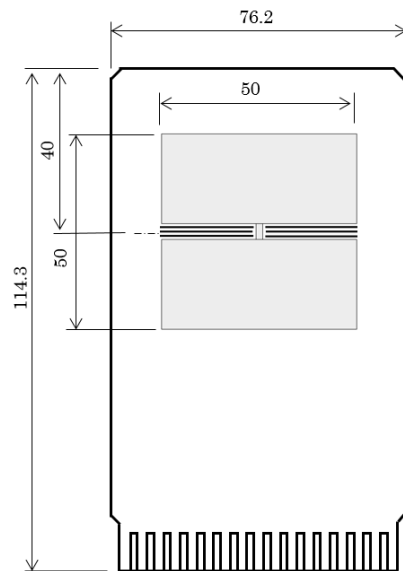

Measurement Board Pattern

# PACKAGE DIMENSIONS

# DFN(PL)1616-6D

DM-DFN(PL)1616-6D-JE-B

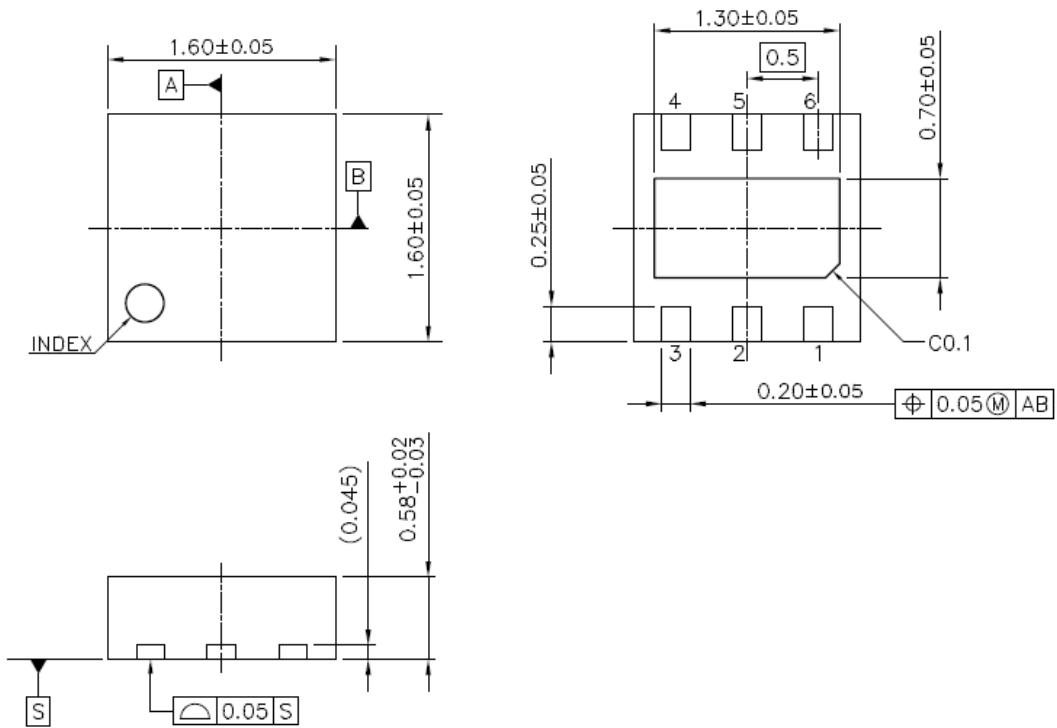

DFN(PL)1616-6D Package Dimensions (Unit: mm)

①②③④: Product Code ... Refer to *Part Marking List*

⑤⑥: Lot Number ... Alphanumeric Serial Number

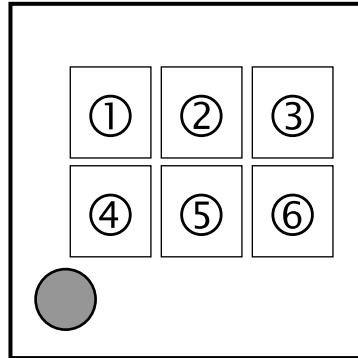

**RP507K (DFN(PL)1616-6D) Part Markings**

**NOTICE**

There can be variation in the marking when different AOI (Automated Optical Inspection) equipment is used. In the case of recognizing the marking characteristic with AOI, please contact our sales or our distributor before attempting to use AOI.

**RP507K Part Marking List**

<b>Product Name</b>	<b>①</b>	<b>②</b>	<b>③</b>	<b>④</b>
RP507K001B	D	X	0	0

1. The products and the product specifications described in this document are subject to change or discontinuation of production without notice for reasons such as improvement. Therefore, before deciding to use the products, please refer to our sales representatives for the latest information thereon.
2. The materials in this document may not be copied or otherwise reproduced in whole or in part without the prior written consent of us.
3. This product and any technical information relating thereto are subject to complementary export controls (so-called KNOW controls) under the Foreign Exchange and Foreign Trade Law, and related politics ministerial ordinance of the law. (Note that the complementary export controls are inapplicable to any application-specific products, except rockets and pilotless aircraft, that are insusceptible to design or program changes.) Accordingly, when exporting or carrying abroad this product, follow the Foreign Exchange and Foreign Trade Control Law and its related regulations with respect to the complementary export controls.
4. The technical information described in this document shows typical characteristics and example application circuits for the products. The release of such information is not to be construed as a warranty of or a grant of license under our or any third party's intellectual property rights or any other rights.
5. The products listed in this document are intended and designed for use as general electronic components in standard applications (office equipment, telecommunication equipment, measuring instruments, consumer electronic products, amusement equipment etc.). Those customers intending to use a product in an application requiring extreme quality and reliability, for example, in a highly specific application where the failure or misoperation of the product could result in human injury or death should first contact us.
  - Aerospace Equipment
  - Equipment Used in the Deep Sea
  - Power Generator Control Equipment (nuclear, steam, hydraulic, etc.)
  - Life Maintenance Medical Equipment
  - Fire Alarms / Intruder Detectors
  - Vehicle Control Equipment (automotive, airplane, railroad, ship, etc.)
  - Various Safety Devices
  - Traffic control system
  - Combustion equipment

In case your company desires to use this product for any applications other than general electronic equipment mentioned above, make sure to contact our company in advance. Note that the important requirements mentioned in this section are not applicable to cases where operation requirements such as application conditions are confirmed by our company in writing after consultation with your company.

6. We are making our continuous effort to improve the quality and reliability of our products, but semiconductor products are likely to fail with certain probability. In order to prevent any injury to persons or damages to property resulting from such failure, customers should be careful enough to incorporate safety measures in their design, such as redundancy feature, fire containment feature and fail-safe feature. We do not assume any liability or responsibility for any loss or damage arising from misuse or inappropriate use of the products.
7. The products have been designed and tested to function within controlled environmental conditions. Do not use products under conditions that deviate from methods or applications specified in this datasheet. Failure to employ the products in the proper applications can lead to deterioration, destruction or failure of the products. We shall not be responsible for any bodily injury, fires or accident, property damage or any consequential damages resulting from misuse or misapplication of the products.
8. **Quality Warranty**
  - 8-1. **Quality Warranty Period**

In the case of a product purchased through an authorized distributor or directly from us, the warranty period for this product shall be one (1) year after delivery to your company. For defective products that occurred during this period, we will take the quality warranty measures described in section 8-2. However, if there is an agreement on the warranty period in the basic transaction agreement, quality assurance agreement, delivery specifications, etc., it shall be followed.
  - 8-2. **Quality Warranty Remedies**

When it has been proved defective due to manufacturing factors as a result of defect analysis by us, we will either deliver a substitute for the defective product or refund the purchase price of the defective product.

Note that such delivery or refund is sole and exclusive remedies to your company for the defective product.
  - 8-3. **Remedies after Quality Warranty Period**

With respect to any defect of this product found after the quality warranty period, the defect will be analyzed by us. On the basis of the defect analysis results, the scope and amounts of damage shall be determined by mutual agreement of both parties. Then we will deal with upper limit in Section 8-2. This provision is not intended to limit any legal rights of your company.
9. Anti-radiation design is not implemented in the products described in this document.
10. The X-ray exposure can influence functions and characteristics of the products. Confirm the product functions and characteristics in the evaluation stage.
11. WLCSP products should be used in light shielded environments. The light exposure can influence functions and characteristics of the products under operation or storage.
12. Warning for handling Gallium and Arsenic (GaAs) products (Applying to GaAs MMIC, Photo Reflector). These products use Gallium (Ga) and Arsenic (As) which are specified as poisonous chemicals by law. For the prevention of a hazard, do not burn, destroy, or process chemically to make them as gas or power. When the product is disposed of, please follow the related regulation and do not mix this with general industrial waste or household waste.
13. Please contact our sales representatives should you have any questions or comments concerning the products or the technical information.



**Nisshinbo Micro Devices Inc.**

**Official website**

<https://www.nisshinbo-microdevices.co.jp/en/>

**Purchase information**

<https://www.nisshinbo-microdevices.co.jp/en/buy/>