

- **Ideal for European 433.420 MHz Remote Control and Security Transmitters**
- **Very Low Series Resistance**
- **Quartz Stability**
- **Complies with Directive 2002/95/EC (RoHS)**
- **Tape and Reel Standard per ANSI/EIA-481**
- **Moisture Sensitivity Level: 1**
- **AEC-Q200 Qualified**

RO3112C

**433.420 MHz
SAW
Resonator**

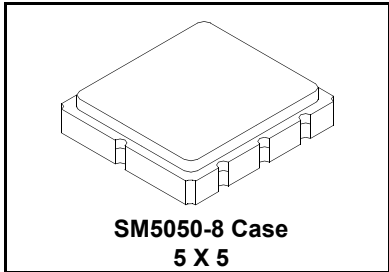

The RO3112C is a true one-port, surface-acoustic-wave (SAW) resonator in a surface-mount ceramic case. It provides reliable, fundamental-mode, quartz frequency stabilization of fixed-frequency transmitters operating at 433.42 MHz. This SAW is designed specifically for use in remote control and wireless security transmitters operating in Europe under ETSI I-ETS 300 220.

Absolute Maximum Ratings

Rating	Value	Units
Input Power Level	0	dBm
DC Voltage	12	VDC
Storage Temperature	-40 to +85	°C
Soldering Temperature (10 seconds / 5 cycles maximum)	260	°C

Electrical Characteristics

Characteristic	Sym	Notes	Minimum	Typical	Maximum	Units
Center Frequency +25 °C	Absolute Frequency	f_C	433.345		433.495	MHz
	Tolerance from 433.420 MHz	Δf_C			±75	kHz
Insertion Loss	IL			1.2	1.5	dB
Quality Factor	Unloaded Q	Q_U		8700		
	50Ω Loaded Q	Q_L		920		
Temperature Stability	Turnover Temperature	T_O	10	25	40	°C
	Turnover Frequency	f_O		f_C		
	Frequency Temperature Coefficient	FTC		0.032		ppm/°C ²
Frequency Aging	Absolute Value during the First Year	$ f_A $		≤10		ppm/yr
DC Insulation Resistance between Any Two Terminals			1.0			MΩ
RF Equivalent RLC Model	Motional Resistance	R_M		11.9		Ω
	Motional Inductance	L_M		37.9		μH
	Motional Capacitance	C_M		3.6		fF
	Shunt Static Capacitance	C_O		3.8		pF
Test Fixture Shunt Inductance	L_{TEST}			35.4		nH
Lid Symbolization (Y = Year, WW = Week, S = Shift)			657, <u>YWWS</u>			
Standard Reel Quantity	Reel Size 7 Inch		500 Pieces/Reel			
	Reel Size 13 Inch		3000 Pieces/Reel			

CAUTION: Electrostatic Sensitive Device. Observe precautions for handling.
NOTES:

1. The design, manufacturing process, and specifications of this device are subject to change.
2. US or International patents may apply.
3. RoHS compliant from the first date of manufacture.

Electrical Connections

The SAW resonator is bidirectional and may be installed with either orientation. The two terminals are interchangeable and unnumbered. The callout NC indicates no internal connection. The NC pads assist with mechanical positioning and stability. External grounding of the NC pads is recommended to help reduce parasitic capacitance in the circuit.

Pin	Connection
1	NC
2	Terminal
3	NC
4	NC
5	NC
6	Terminal
7	NC
8	NC

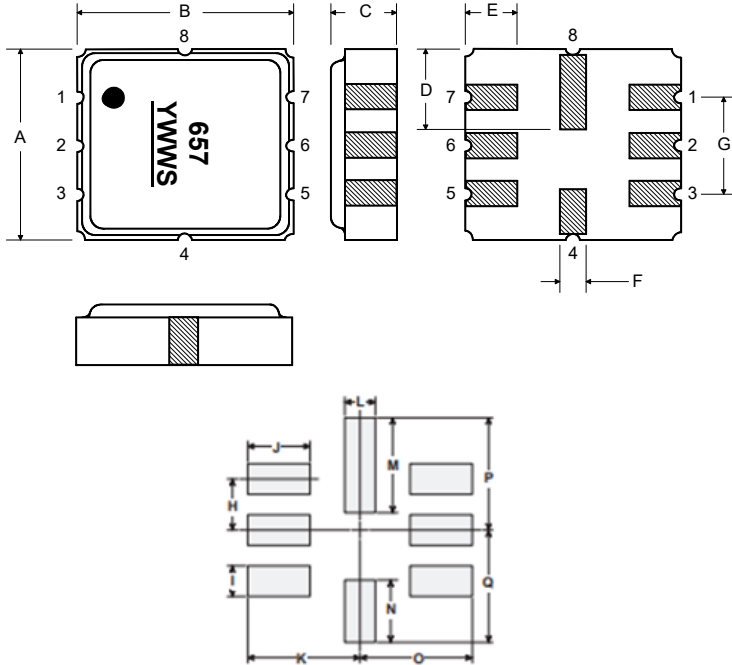

Dimension	mm			Inches		
	Min	Nom	Max	Min	Nom	Max
A	4.80	5.00	5.20	0.189	0.197	0.205
B	4.80	5.00	5.20	0.189	0.197	0.205
C	1.30	1.50	1.70	0.050	0.060	0.067
D	1.98	2.08	2.18	0.078	0.082	0.086
E	1.07	1.17	1.27	0.042	0.046	0.050
F	0.50	0.64	0.70	0.020	0.025	0.028
G	2.39	2.54	2.69	0.094	0.100	0.106
H		1.27			0.050	
I		0.76			0.030	
J		1.55			0.061	
K		2.79			0.110	
L		0.76			0.030	
M		2.36			0.093	
N		1.55			0.061	
O		2.79			0.110	
P		2.79			0.110	
Q		2.79			0.110	

Parameter Test Circuit

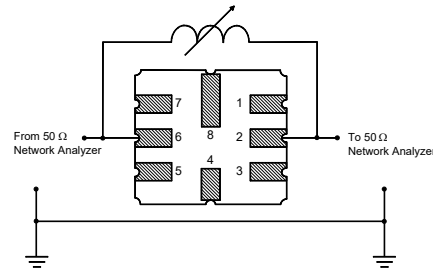

Power Test Circuit

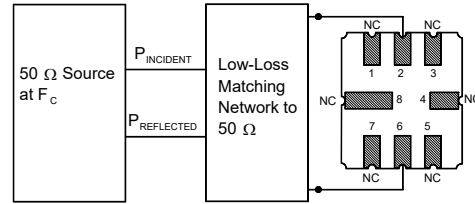

Example Application Circuits

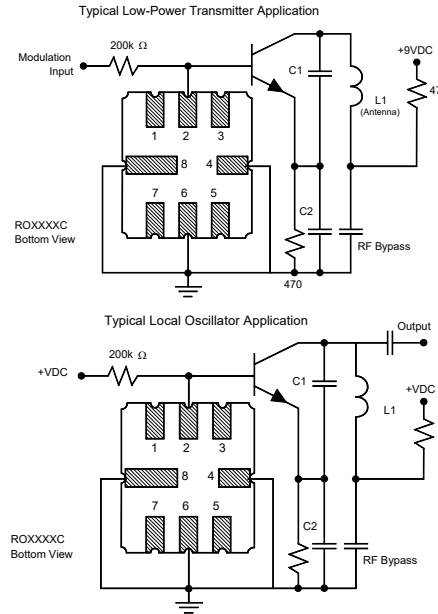

Equivalent RLC Model

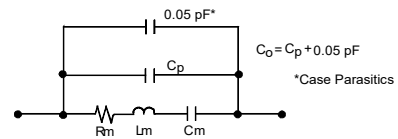

Temperature Characteristics

The curve shown on the right accounts for resonator contribution only and does not include LC component temperature contributions.

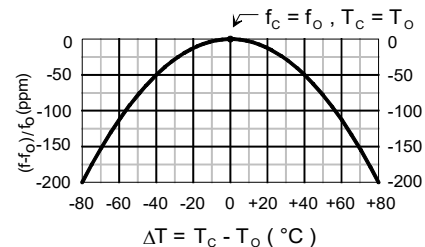

Recommended Reflow Profile

1. Preheating shall be fixed at 150~180°C for 60~90 seconds.
2. Ascending time to preheating temperature 150°C shall be 30 seconds min.
3. Heating shall be fixed at 220°C for 50~80 seconds and at 260°C +0/-5°C peak (10 seconds).
4. Time: 5 times maximum.

