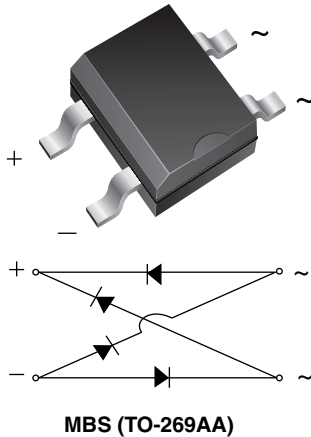

Miniature Glass Passivated Fast Recovery Surface-Mount Bridge Rectifier

MBS (TO-269AA)

LINKS TO ADDITIONAL RESOURCES

[3D Models](#)

PRIMARY CHARACTERISTICS

| | |
|------------------------|----------------|
| $I_{F(AV)}$ | 0.5 A |
| V_{RRM} | 200 V, 400 V |
| I_{FSM} | 30 A |
| t_{rr} | 150 ns |
| V_F at $I_F = 0.4$ A | 1.25 V |
| T_J max. | 150 °C |
| Package | MBS (TO-269AA) |
| Circuit configuration | Quad |

MAXIMUM RATINGS ($T_A = 25$ °C unless otherwise noted)

| PARAMETER | SYMBOL | RMB2S | RMB4S | UNIT |
|--|----------------|--------------------------------------|-------|------------------|
| Device marking code | | 2R | 4R | |
| Maximum repetitive peak reverse voltage | V_{RRM} | 200 | 400 | V |
| Maximum RMS voltage | V_{RMS} | 140 | 280 | V |
| Maximum DC blocking voltage | V_{DC} | 200 | 400 | V |
| Maximum average forward output rectified current at $T_A = 30$ °C | $I_{F(AV)}$ | on glass-epoxy PCB ⁽¹⁾ | | A |
| | | on aluminum substrate ⁽²⁾ | | |
| Peak forward surge current 8.3 ms single half sine-wave superimposed on rated load | I_{FSM} | 30 | | A |
| Rating for fusing ($t < 8.3$ ms) | I^2t | 5.0 | | A ² s |
| Operating junction and storage temperature range | T_J, T_{STG} | -55 to +150 | | °C |

Notes

⁽¹⁾ On glass epoxy PCB mounted on 0.05" x 0.05" (1.3 mm x 1.3 mm) pads

⁽²⁾ On aluminum substrate PCB with an area of 0.8" x 0.8" (20 mm x 20 mm) mounted on 0.05" x 0.05" (1.3 mm x 1.3 mm) solder pad

FEATURES

- UL recognition, file number E54214
- Saves space on printed circuit boards
- Ideal for automated placement
- Fast recovery, low switching loss
- High surge current capability
- Meets MSL level 1, per J-STD-020, LF maximum peak of 260 °C
- Material categorization: for definitions of compliance please see www.vishay.com/doc?99912

RoHS
COMPLIANT

TYPICAL APPLICATIONS

General purpose use in AC/DC bridge full wave rectification for power supply, lighting ballaster, battery charger, home appliances, office equipment, and telecommunication applications.

MECHANICAL DATA

Case: MBS (TO-269AA)

Molding compound meets UL 94 V-0 flammability rating Base P/N-E3 - RoHS-compliant, commercial grade

Terminals: matte tin plated leads, solderable per J-STD-002 and JESD22-B102

E3 suffix meets JESD 201 class 1A whisker test

Polarity: as marked on body



| ELECTRICAL CHARACTERISTICS ($T_A = 25\text{ }^\circ\text{C}$ unless otherwise noted) | | | | | |
|--|---|----------|-------|-------|---------------|
| PARAMETER | TEST CONDITIONS | SYMBOL | RMB2S | RMB4S | UNIT |
| Maximum instantaneous forward voltage per diode | $I_F = 0.4\text{ A}$ | V_F | 1.25 | | V |
| Maximum DC reverse current at rated DC blocking voltage per diode | $T_A = 25\text{ }^\circ\text{C}$ | I_R | 5.0 | | μA |
| | $T_A = 125\text{ }^\circ\text{C}$ | | 100 | | |
| Maximum reverse recovery time per diode | $I_F = 0.5\text{ A}$, $I_R = 1.0\text{ A}$, $I_{rr} = 0.25\text{ A}$ | t_{rr} | 150 | | ns |
| Typical junction capacitance per diode | 4.0 V, 1 MHz | C_J | 13 | | pF |

| THERMAL CHARACTERISTICS ($T_A = 25\text{ }^\circ\text{C}$ unless otherwise noted) | | | | |
|---|--------------------------------|-------|-------|--------------------|
| PARAMETER | SYMBOL | RMB2S | RMB4S | UNIT |
| Typical thermal resistance ⁽¹⁾ | $R_{\theta JA}$ ⁽¹⁾ | 85 | | $^\circ\text{C/W}$ |
| | $R_{\theta JA}$ ⁽²⁾ | 70 | | |
| | $R_{\theta JL}$ ⁽¹⁾ | 20 | | |

Notes

⁽¹⁾ On glass epoxy PCB mounted on 0.05" x 0.05" (1.3 mm x 1.3 mm) pads

⁽²⁾ On aluminum substrate PCB with an area of 0.8" x 0.8" (20 mm x 20 mm) mounted on 0.05" x 0.05" (1.3 mm x 1.3 mm) solder pad

| ORDERING INFORMATION (Example) | | | | |
|---------------------------------------|-----------------|------------------------|---------------|----------------------------------|
| PREFERRED P/N | UNIT WEIGHT (g) | PREFERRED PACKAGE CODE | BASE QUANTITY | DELIVERY MODE |
| RMB4S-E3/45 | 0.22 | 45 | 100 | Tube |
| RMB4S-E3/80 | 0.22 | 80 | 3000 | 13" diameter paper tape and reel |

RATINGS AND CHARACTERISTICS CURVES ($T_A = 25\text{ }^\circ\text{C}$ unless otherwise noted)

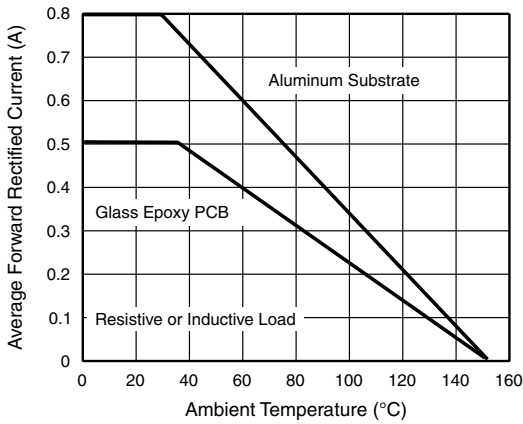

Fig. 1 - Maximum Forward Current Derating Curve

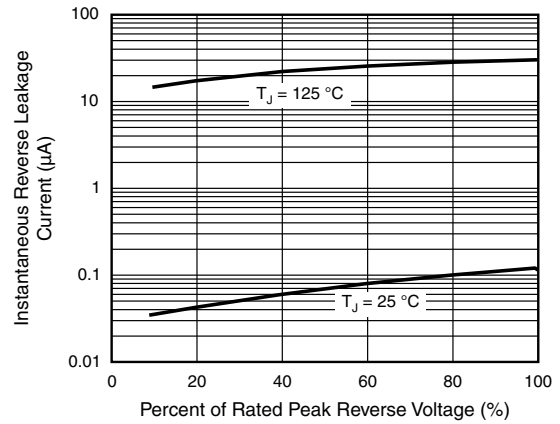

Fig. 4 - Typical Reverse Leakage Characteristics Per Diode

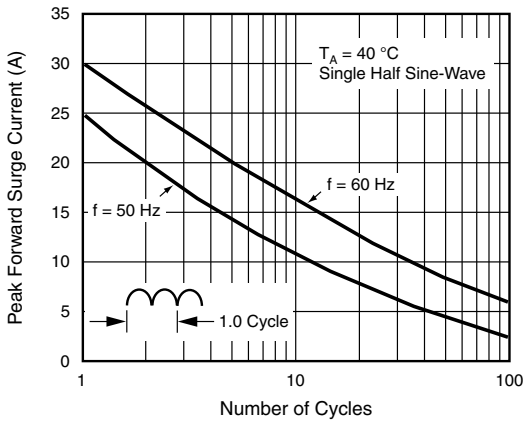

Fig. 2 - Maximum Non-Repetitive Peak Forward Surge Current Per Diode

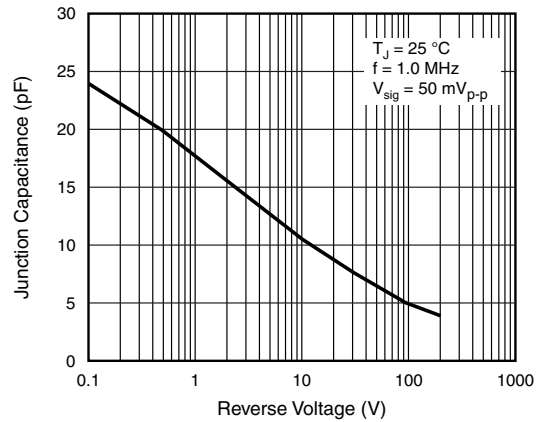

Fig. 5 - Typical Junction Capacitance Per Diode

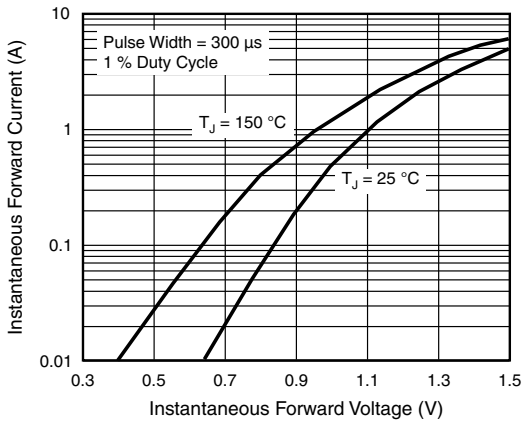
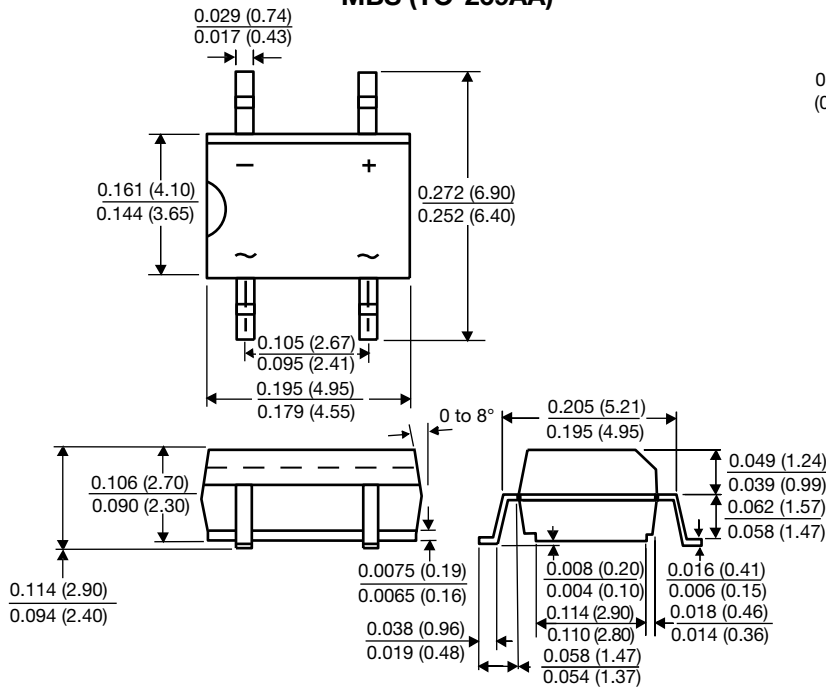

Fig. 3 - Typical Instantaneous Forward Characteristics Per Diode



PACKAGE OUTLINE DIMENSIONS in inches (millimeters)

MBS (TO-269AA)



Mounting Pad Layout

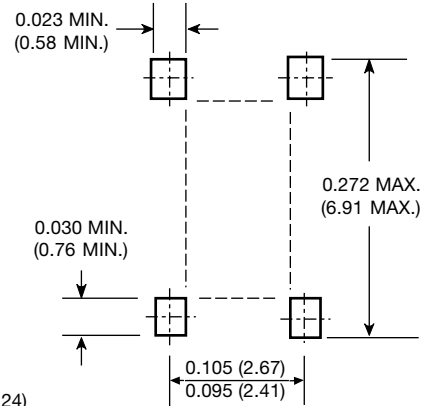



Disclaimer

ALL PRODUCT, PRODUCT SPECIFICATIONS AND DATA ARE SUBJECT TO CHANGE WITHOUT NOTICE TO IMPROVE RELIABILITY, FUNCTION OR DESIGN OR OTHERWISE.

Vishay Intertechnology, Inc., its affiliates, agents, and employees, and all persons acting on its or their behalf (collectively, "Vishay"), disclaim any and all liability for any errors, inaccuracies or incompleteness contained in any datasheet or in any other disclosure relating to any product.

Vishay makes no warranty, representation or guarantee regarding the suitability of the products for any particular purpose or the continuing production of any product. To the maximum extent permitted by applicable law, Vishay disclaims (i) any and all liability arising out of the application or use of any product, (ii) any and all liability, including without limitation special, consequential or incidental damages, and (iii) any and all implied warranties, including warranties of fitness for particular purpose, non-infringement and merchantability.

Statements regarding the suitability of products for certain types of applications are based on Vishay's knowledge of typical requirements that are often placed on Vishay products in generic applications. Such statements are not binding statements about the suitability of products for a particular application. It is the customer's responsibility to validate that a particular product with the properties described in the product specification is suitable for use in a particular application. Parameters provided in datasheets and / or specifications may vary in different applications and performance may vary over time. All operating parameters, including typical parameters, must be validated for each customer application by the customer's technical experts. Product specifications do not expand or otherwise modify Vishay's terms and conditions of purchase, including but not limited to the warranty expressed therein.

Hyperlinks included in this datasheet may direct users to third-party websites. These links are provided as a convenience and for informational purposes only. Inclusion of these hyperlinks does not constitute an endorsement or an approval by Vishay of any of the products, services or opinions of the corporation, organization or individual associated with the third-party website. Vishay disclaims any and all liability and bears no responsibility for the accuracy, legality or content of the third-party website or for that of subsequent links.

Except as expressly indicated in writing, Vishay products are not designed for use in medical, life-saving, or life-sustaining applications or for any other application in which the failure of the Vishay product could result in personal injury or death. Customers using or selling Vishay products not expressly indicated for use in such applications do so at their own risk. Please contact authorized Vishay personnel to obtain written terms and conditions regarding products designed for such applications.

No license, express or implied, by estoppel or otherwise, to any intellectual property rights is granted by this document or by any conduct of Vishay. Product names and markings noted herein may be trademarks of their respective owners.