

## N-Channel Enhancement Mode Power MOSFET

### Description

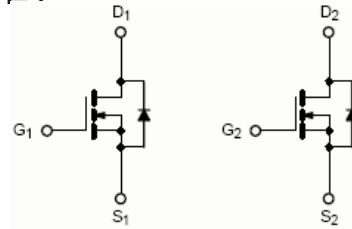
The RM9926 uses advanced trench technology and design to provide excellent  $R_{DS(ON)}$  with low gate charge. It can be used in a wide variety of applications.

### General Features

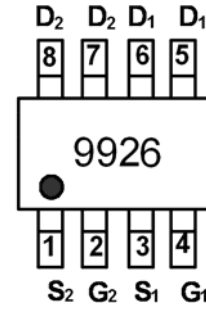
- $V_{DS} = 20V, I_D = 6A$   
 $R_{DS(ON)} < 28m\Omega @ V_{GS} = 4.5V$   
 $R_{DS(ON)} < 37m\Omega @ V_{GS} = 2.5V$
- High density cell design for ultra low  $R_{dson}$
- Fully characterized avalanche voltage and current

### Application

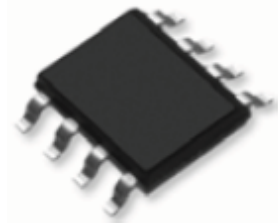
- Power switching application
- Hard switched and high frequency circuits
- Uninterruptible power supply



Schematic diagram



Marking and pin Assignment



SOP-8 top view

### Package Marking and Ordering Information

Device Marking	Device	Device Package	Reel Size	Tape width	Quantity
9926	RM9926	SOP-8	Ø330mm	12mm	2500 units

### Absolute Maximum Ratings ( $T_A = 25^\circ\text{C}$ unless otherwise noted)

Parameter	Symbol	Limit	Unit
Drain-Source Voltage	$V_{DS}$	20	V
Gate-Source Voltage	$V_{GS}$	$\pm 10$	V
Drain Current-Continuous	$I_D$	6	A
Drain Current-Continuous( $T_C = 100^\circ\text{C}$ )	$I_D(100^\circ\text{C})$	3.8	A
Pulsed Drain Current	$I_{DM}$	25	A
Maximum Power Dissipation	$P_D$	1.25	W
Operating Junction and Storage Temperature Range	$T_J, T_{STG}$	-55 To 150	$^\circ\text{C}$

### Thermal Characteristic

Thermal Resistance, Junction-to-Ambient <sup>(Note 2)</sup>	$R_{\theta JA}$	100	$^\circ\text{C/W}$
---	-----------------	-----	--------------------

## Electrical Characteristics (T<sub>A</sub>=25°C unless otherwise noted)

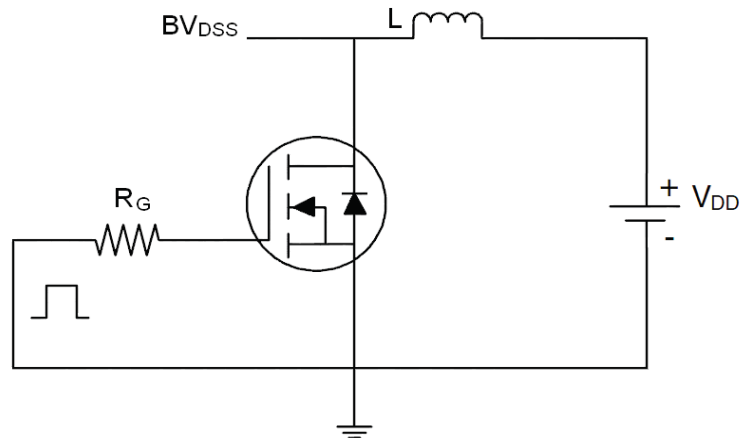
Parameter	Symbol	Condition	Min	Typ	Max	Unit
<b>Off Characteristics</b>						
Drain-Source Breakdown Voltage	BV <sub>DSS</sub>	V <sub>GS</sub> =0V I <sub>D</sub> =250μA	20	22	-	V
Zero Gate Voltage Drain Current	I <sub>DSS</sub>	V <sub>DS</sub> =20V, V <sub>GS</sub> =0V	-	-	1	μA
Gate-Body Leakage Current	I <sub>GSS</sub>	V <sub>GS</sub> =±10V, V <sub>DS</sub> =0V	-	-	±100	nA
<b>On Characteristics</b> (Note 3)						
Gate Threshold Voltage	V <sub>GS(th)</sub>	V <sub>DS</sub> =V <sub>GS</sub> , I <sub>D</sub> =250μA	0.5	0.7	1.2	V
Drain-Source On-State Resistance	R <sub>DS(ON)</sub>	V <sub>GS</sub> =4.5V, I <sub>D</sub> =6A	-	20	28	mΩ
		V <sub>GS</sub> =2.5V, I <sub>D</sub> =5A	-	26	37	
Forward Transconductance	g <sub>FS</sub>	V <sub>DS</sub> =5V, I <sub>D</sub> =6A	20	-	-	S
<b>Dynamic Characteristics</b> (Note 4)						
Input Capacitance	C <sub>iss</sub>	V <sub>DS</sub> =10V, V <sub>GS</sub> =0V, F=1.0MHz	-	640	-	PF
Output Capacitance	C <sub>oss</sub>		-	140	-	PF
Reverse Transfer Capacitance	C <sub>rss</sub>		-	80	-	PF
<b>Switching Characteristics</b> (Note 4)						
Turn-on Delay Time	t <sub>d(on)</sub>	V <sub>DD</sub> =10V, I <sub>D</sub> =1A V <sub>GEN</sub> =4.5V, R <sub>G</sub> =6Ω	-	8	-	nS
Turn-on Rise Time	t <sub>r</sub>		-	9	-	nS
Turn-Off Delay Time	t <sub>d(off)</sub>		-	15	-	nS
Turn-Off Fall Time	t <sub>f</sub>		-	4	-	nS
Total Gate Charge	Q <sub>g</sub>	V <sub>DS</sub> =10V, I <sub>D</sub> =3A, V <sub>GS</sub> =4.5V	-	10	-	nC
Gate-Source Charge	Q <sub>gs</sub>		-	1.5	-	nC
Gate-Drain Charge	Q <sub>gd</sub>		-	1.6	-	nC
<b>Drain-Source Diode Characteristics</b>						
Diode Forward Voltage (Note 3)	V <sub>SD</sub>	V <sub>GS</sub> =0V, I <sub>S</sub> =1.7A	-	-	1.2	V
Diode Forward Current (Note 2)	I <sub>S</sub>		-	-	6	A

### Notes:

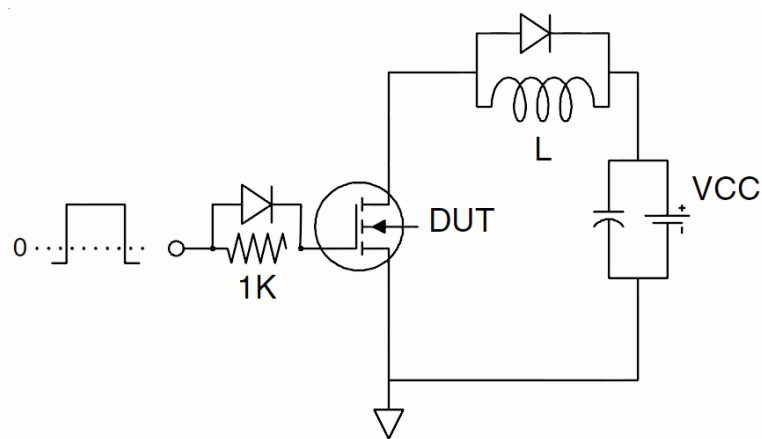
1. Repetitive Rating: Pulse width limited by maximum junction temperature.
2. Surface Mounted on FR4 Board, t ≤ 10 sec.
3. Pulse Test: Pulse Width ≤ 300μs, Duty Cycle ≤ 2%.
4. Guaranteed by design, not subject to production

## Test Circuit

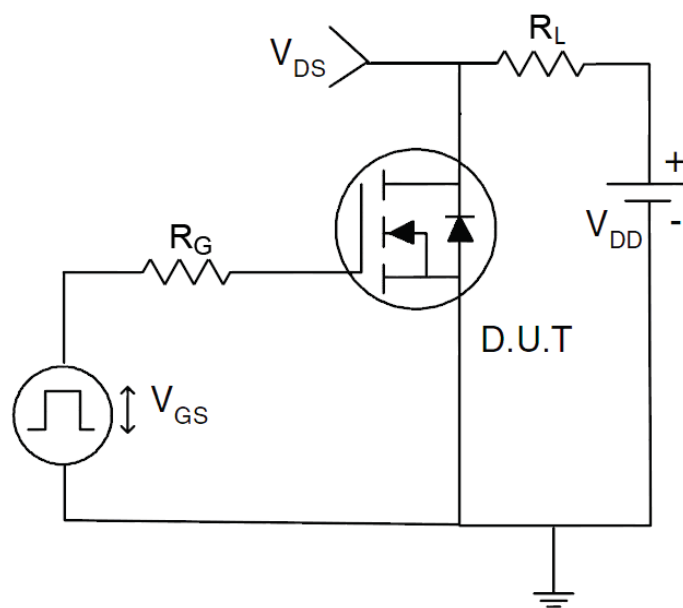
### 1) $E_{AS}$ Test Circuits



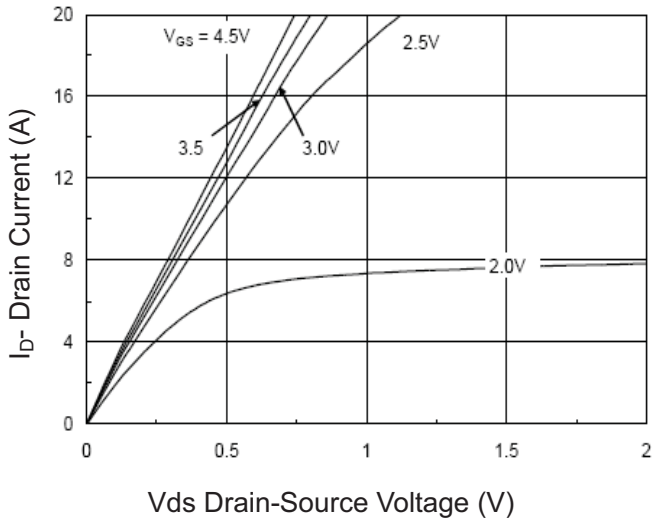
### 2) Gate Charge Test Circuit:



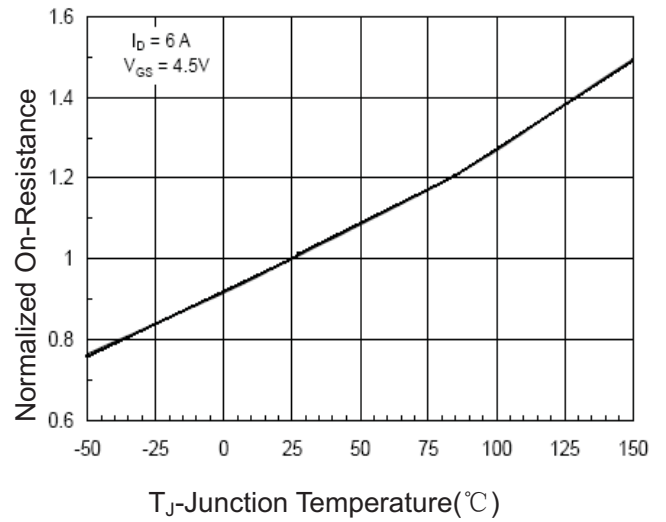
### 3) Switch Time Test Circuit:



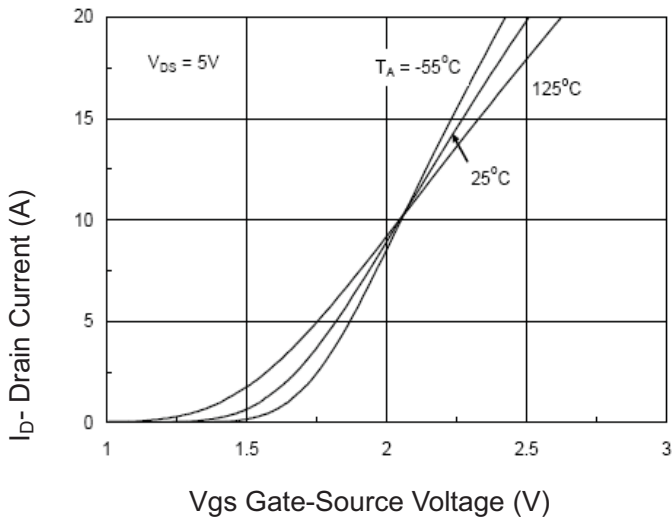
## RATING AND CHARACTERISTICS CURVES (RM9926)



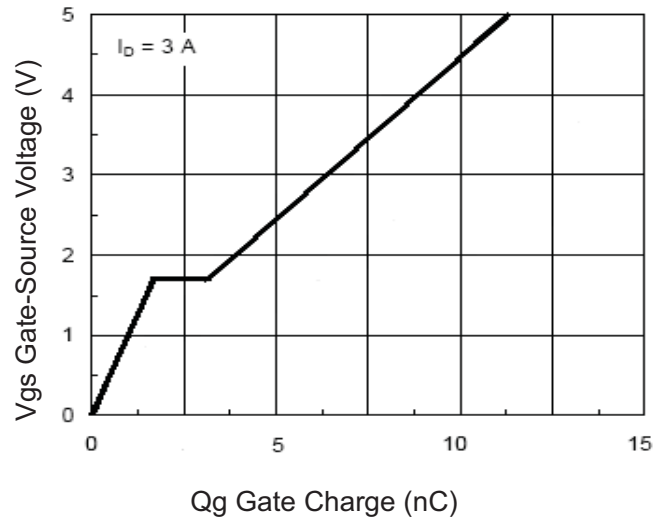
**Figure 1 Output Characteristics**



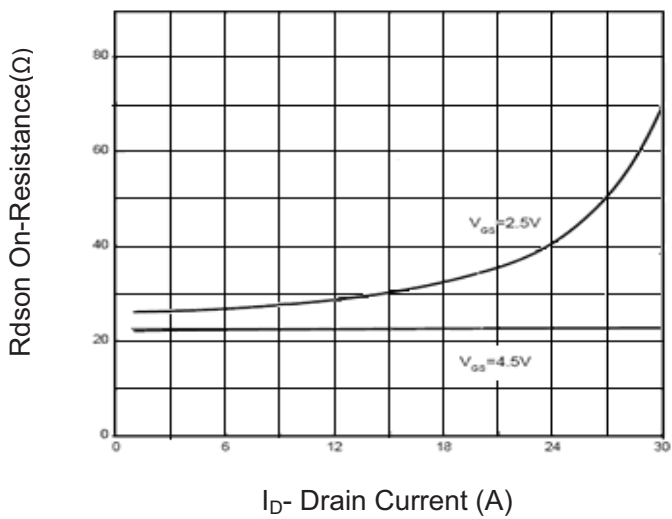
**Figure 4 Rdson-Junction Temperature**



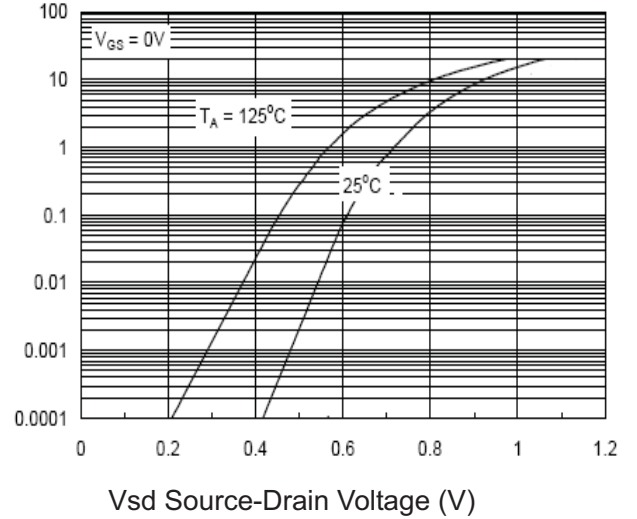
**Figure 2 Transfer Characteristics**



**Figure 5 Gate Charge**

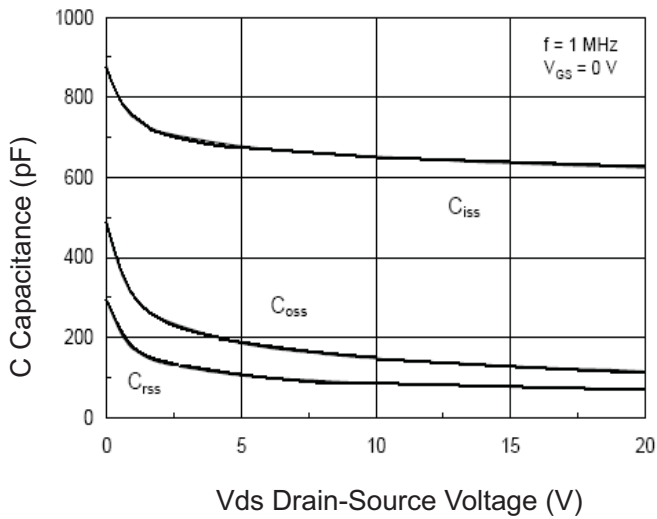


**Figure 3 Rdson- Drain Current**

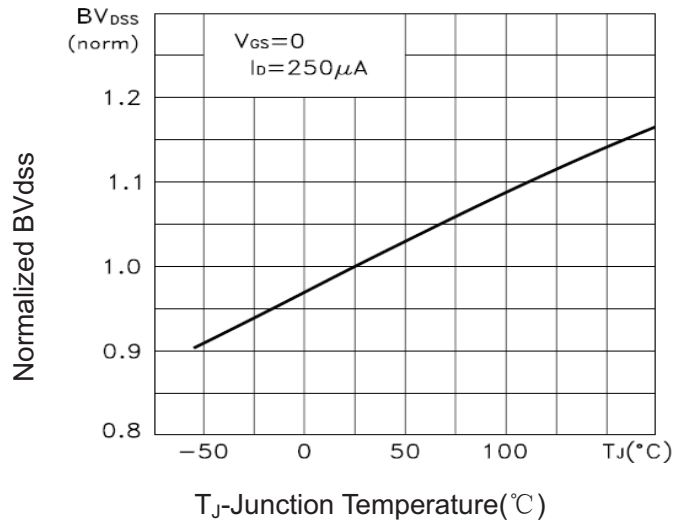


**Figure 6 Source- Drain Diode Forward**

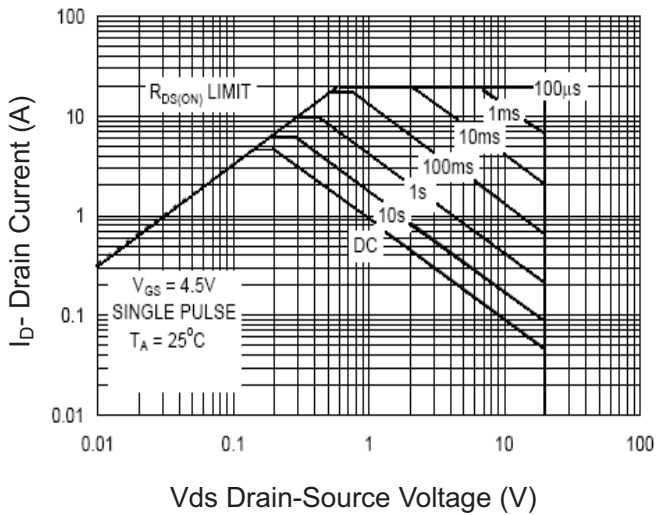
## RATING AND CHARACTERISTICS CURVES (RM9926)



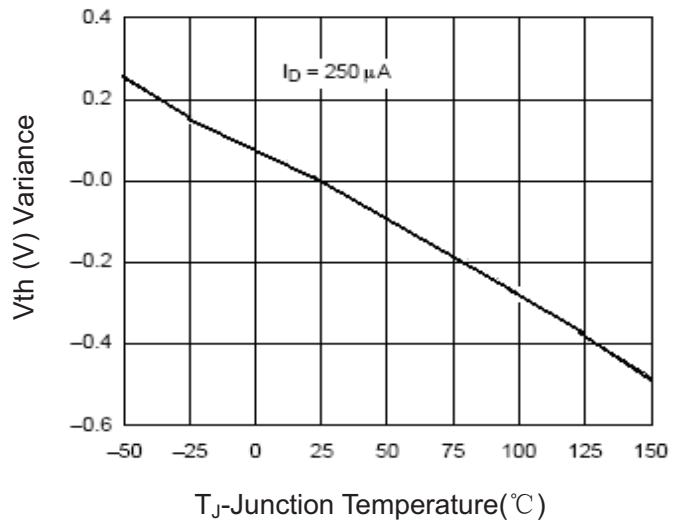
Vds Drain-Source Voltage (V)  
**Figure 7 Capacitance vs Vds**



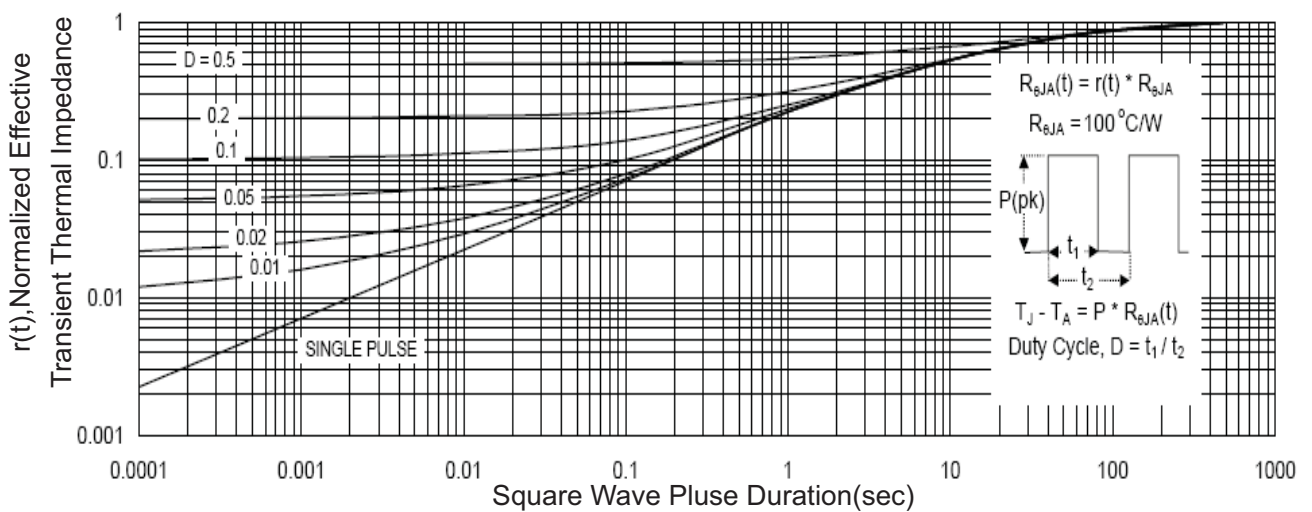
$T_J$ -Junction Temperature( $^\circ\text{C}$ )  
**Figure 9  $BV_{DSS}$  vs Junction Temperature**



Vds Drain-Source Voltage (V)  
**Figure 8 Safe Operation Area**

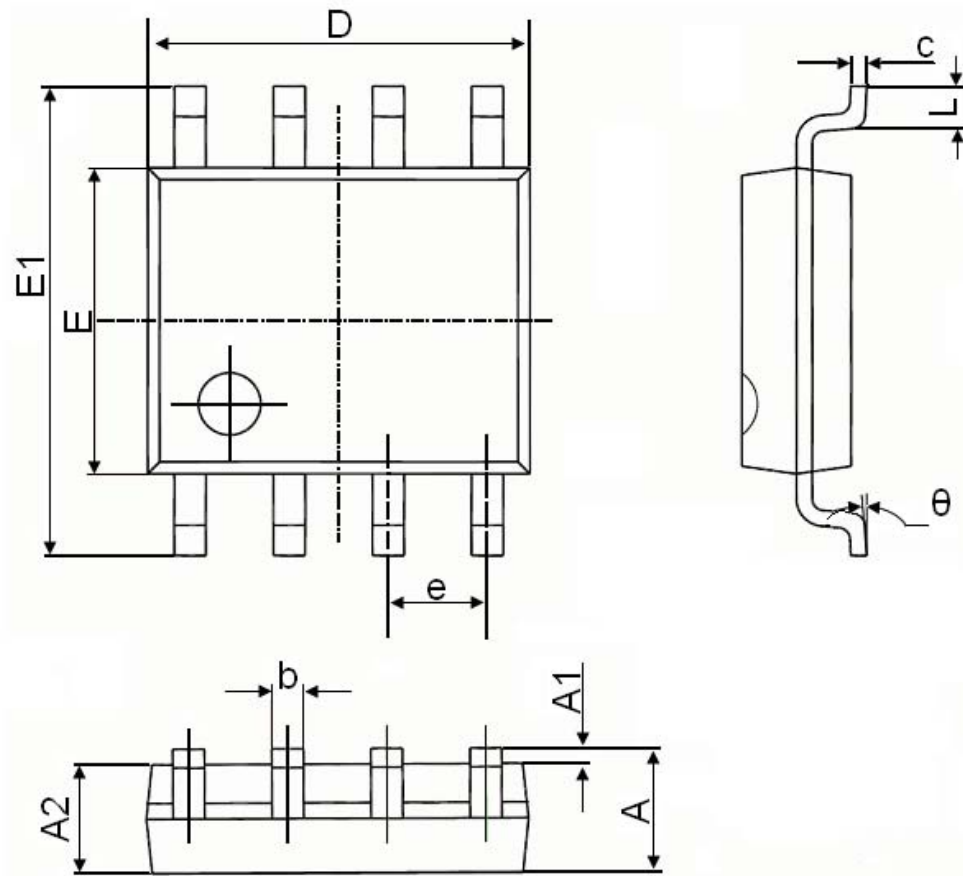


$T_J$ -Junction Temperature( $^\circ\text{C}$ )  
**Figure 10  $V_{GS(th)}$  vs Junction Temperature**



Square Wave Pulse Duration(sec)  
**Figure 11 Normalized Maximum Transient Thermal Impedance**

## SOP-8 Package Information



Symbol	Dimensions In Millimeters		Dimensions In Inches	
	Min.	Max.	Min.	Max.
A	1.350	1.750	0.053	0.069
A1	0.100	0.250	0.004	0.010
A2	1.350	1.550	0.053	0.061
b	0.330	0.510	0.013	0.020
c	0.170	0.250	0.006	0.010
D	4.700	5.100	0.185	0.200
E	3.800	4.000	0.150	0.157
E1	5.800	6.200	0.228	0.244
e	1.270(BSC)		0.050(BSC)	
L	0.400	1.270	0.016	0.050
$\theta$	0°	8°	0°	8°

## DISCLAIMER NOTICE

Rectron Inc reserves the right to make changes without notice to any product specification herein, to make corrections, modifications, enhancements or other changes. Rectron Inc or anyone on its behalf assumes no responsibility or liability for any errors or inaccuracies. Data sheet specifications and its information contained are intended to provide a product description only. "Typical" parameters which may be included on RECTRON data sheets and/ or specifications can and do vary in different applications and actual performance may vary over time. Rectron Inc does not assume any liability arising out of the application or use of any product or circuit.

Rectron products are not designed, intended or authorized for use in medical, life-saving implant or other applications intended for life-sustaining or other related applications where a failure or malfunction of component or circuitry may directly or indirectly cause injury or threaten a life without expressed written approval of Rectron Inc. Customers using or selling Rectron components for use in such applications do so at their own risk and shall agree to fully indemnify Rectron Inc and its subsidiaries harmless against all claims, damages and expenditures.